

Smart Camera
FQ2-S/CH Series

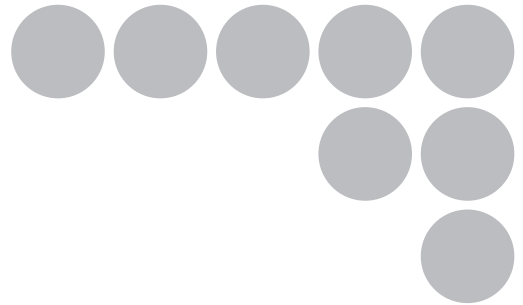

User's Manual for Communications Settings



Introduction

Thank you for purchasing the FQ2-S/CH.

This manual provides information regarding functions, performance and operating methods that are required for using the FQ2-S/CH.

When using the FQ2-S/CH, be sure to observe the following:

- The FQ2-S/CH must be operated by personnel knowledgeable in electrical engineering.
- To ensure correct use, please read this manual thoroughly to deepen your understanding of the product.
- Please keep this manual in a safe place so that it can be referred to whenever necessary.

User's Manual for Communications Settings

APPLICATION CONSIDERATIONS
(Please Read)

Overview of Communication Specifications

1

Controlling Operation and Outputting
Data with a Parallel Connection

2

Controlling Operation and Outputting
Data with an Ethernet Connection

3

Controlling Operation and Outputting
Data with an RS-232C Connection

4

Appendices

5

Product manuals

The information required to use the FQ2-S/CH Series is divided into two manuals by objective: "FQ2-S/CH Series User's Manual" and "FQ2-S/CH Series User's Manual for Communications Settings". Read each manual as appropriate for your objective.

Manual	Description	Contents
FQ2-S/CH Series User's Manual (Cat. No. Z337)	Describes the product specifications, basic settings, and other information required to use the FQ2-S/CH Series.	Product specifications Connections, wiring Camera, image adjustment Inspection item settings Test measurement, operation Troubleshooting
(This manual) FQ2-S/CH Series User's Manual for Communications Settings (Cat. No. Z338)	Provides information required to operate the sensor by remote control.	System configuration Sensor control method Data input/output specifications Connectable network types Communication settings Output data settings

Editor's Note

■ Meaning of Symbols

Menu items that are displayed on the Touch Finder LCD screen, and windows, dialog boxes and other GUI elements displayed on the PC are indicated enclosed by brackets "[]".

■ Visual Aids

Important

Indicates points that are important to achieve the full product performance, such as operational precautions.

Note

Indicates application procedures.



Indicates pages where related information can be found.

2-2 Par

FQ2-S1 FQ2-S2 FQ2-S3

Shows the models that support the function being described.

FQ2-CH1

- FQ2-S1** Shows that the FQ2-S1 supports the function.
- FQ2-S2** Shows that the FQ2-S2 supports the function.
- FQ2-S3** Shows that the FQ2-S3 supports the function.
- FQ2-S4** Shows that the FQ2-S4 supports the function.
- FQ2-CH** Shows that the FQ2-CH supports the function.

Table of Contents

1. Overview of Communication Specifications

1-1 Confirming the System Configuration	8
FQ2-S/CH Series System Configuration	8
1-2 Communicating with an External Device	10
Basic Control Operations of the Sensor	10
Control Methods for the Sensor	11
Communication Protocols for Communication with the Sensor	12
1-3 Control Methods Using an External Device	18
Control with Control Signals and Status Signals	18
Command/Response Method	20
Data Output after Measurements	21

2. Controlling Operation and Outputting Data with a Parallel Connection

2-1 Controlling Operation and Outputting Data with the Sensor's Standard Parallel Connection	34
Basic Operation with a Parallel Connection	34
Setting the Measurement Trigger	36
Setting the Outputs	40
Controlling the Sensor from an External Device	46
2-2 Controlling Operation and Outputting Data with a Parallel Interface Sensor Data Unit	60
Overview	60
Setting the Measurement Trigger	60
Setting Output Data	61
Aligning the Data Output Timing with the External Device	66
Changing the Settings of the I/O Signals	74
Controlling Operation from an External Device	75

3. Controlling Operation and Outputting Data with an Ethernet Connection

- 3-1 Controlling Operation and Outputting Data with EtherNet/IP Communications 88**
 - Introduction to EtherNet/IP 88
 - FQ2 Communications for EtherNet/IP Connections 90
 - Setting Up EtherNet/IP Communications 92
 - Tag Data Link Setting Methods 95
 - Setting the Data to Output Automatically after Measurements 97
 - Memory Assignments and Commands 102
 - Timing Chart for EtherNet/IP Communications 114
 - Sample Ladder Programming 119
 - Communicating with the Sensor Controller with EtherNet/IP Message Communications 120
 - Command Setting Example 120
- 3-2 Controlling Operation and Outputting Data with PLC Link Communications 121**
 - Communications Processing Flow 121
 - Setting Up PLC Link Communications 122
 - Setting the Data to Output Automatically after Measurements 124
 - Memory Assignments for PLC Link Communications 129
 - Timing Chart for PLC Link Communications 137
 - Sample Ladder Programming 139
- 3-3 Outputting Data and Controlling Operation through PROFINET 140**
 - Overview of PROFINET 140
 - FQ2 Communications for PROFINET Connections 144
 - Setting Up EtherNet/IP Communications (PROFINET) 145
 - Communication Settings Procedure 147
 - Setting the Data to Output Automatically after Measurements 148
 - Memory Assignments and Commands 152
 - Timing Chart for EtherNet/IP Communications 161
 - Sample Ladder Programming 165
- 3-4 Control and Output in No-Protocol (TCP) / No-Protocol (UDP) 167**
 - Communications Processing Flow 167
 - Setting Up No-protocol Communications 167
 - Setting the Data to Output Automatically after Measurements 169
 - Controlling the Sensor from an External Device (Procedure for No-protocol Command/Response Communications) 176
 - Binary Data File Load and Save Commands 183

3-5 Controlling Operation and Outputting Data with FINS/TCP No-protocol Commands	188
Introduction to FINS Commands	188
Setting Up FINS/TCP No-protocol Communications	189
List of FINS Commands	190

4. Controlling Operation and Outputting Data with an RS-232C Connection

4-1 Introduction to RS-232C Connections	196
4-2 Controlling Operation and Outputting Data with RS-232C No-protocol Communications	197
Communications Processing Flow	197
Setting Up No-protocol Communications	197
Setting the Data to Output Automatically after Measurements	198
Controlling the Sensor from an External Device (Procedure for No-protocol Command/Response Communications)	198

5. Appendices

5-1 Command Control	200
Parameter Notation Examples for Command Control	200
Command List	202
Command Details	207
5-2 Detailed EtherNet/IP Communications Specifications	433
Index	438
Revision History	440

Overview of Communication Specifications

1-1 Confirming the System Configuration	8
1-2 Communicating with an External Device	10
1-3 Control Methods Using an External Device	18

1-1 Confirming the System Configuration

FQ2-S1

FQ2-S2

FQ2-S3

FQ2-S4

FQ2-CH

The FQ2-S/CH series is Vision System that perform measurement processing through measurement objects that are imaged by a Camera.

In a system configuration that is connected to a PLC, computer, or other external device, measurement commands can be received from and measurement results can be output to the external device.

FQ2-S/CH Series System Configuration

The following types of system configurations can be used with the FQ2.

Parallel Interface Connection

Connection with Standard Parallel Interface of the Vision Sensor

FQ2-S1

FQ2-S2

FQ2-S3

FQ2-S4

FQ2-CH

Use an I/O cable for input of measurement triggers and communication commands, and for output of OK/NG judgement results.

Basic configuration

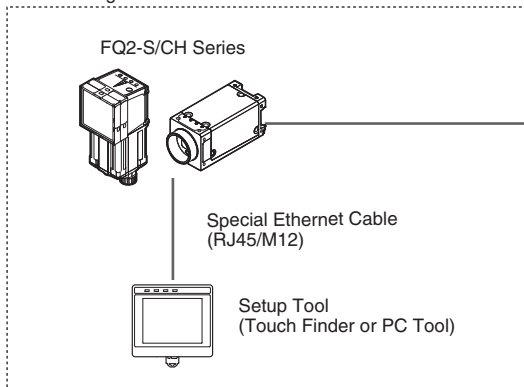

External devices

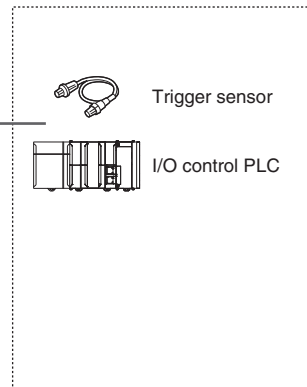

Connection through a Parallel Interface Sensor Data Unit

FQ2-S3

FQ2-S4

FQ2-CH

A Parallel Interface Sensor Data Unit can be installed to enable output of measured values, parameters, calculation results, and other information.

Basic configuration

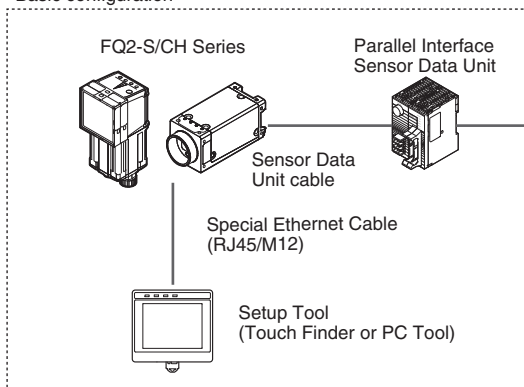

External devices

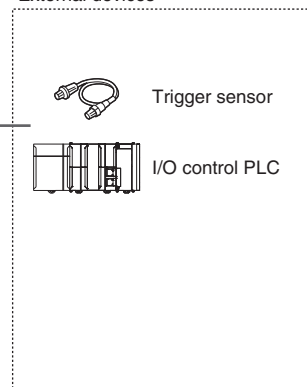

Ethernet (EtherNet/IP, PLC Link, No-protocol, or PROFINET) Connection

FQ2-S1 FQ2-S2 FQ2-S3 FQ2-S4 FQ2-CH

Ethernet cable can be used to connect to a variety of networks in order to input measurement triggers and communication commands, and to output measurement results (judgement results, measured values). Measurement triggers can also be input from a parallel connection. The data link function for each network (excluding no-protocol networks) can be used to periodically transfer data between the sensor and external devices.

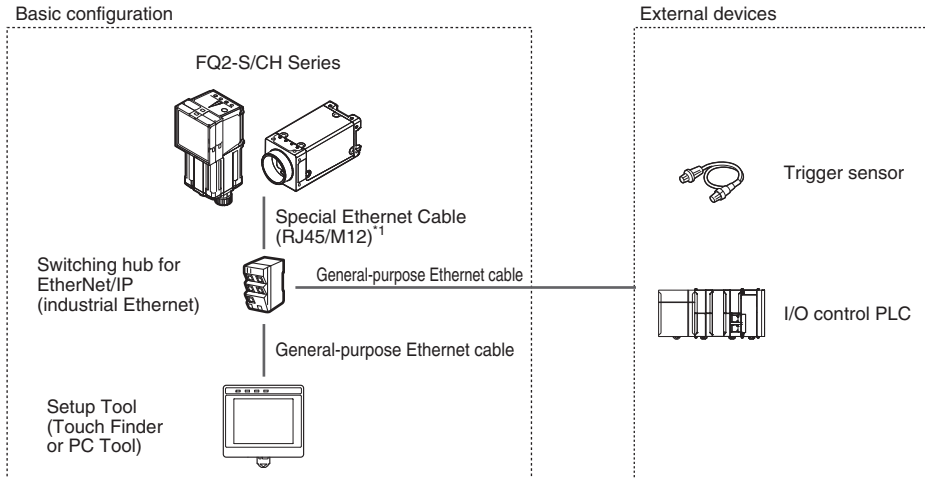

*1: A special Ethernet cable is used to connect to the sensor.

RS-232C Serial Connection

FQ2-S3 FQ2-S4 FQ2-CH

An RS-232C Interface Sensor Data Unit can be connected to the Sensor by RS-232C cable to enable input of measurement triggers and communication commands, and output of measurement results (judgement results, measured values). Measurement triggers can also be input from a parallel connection.

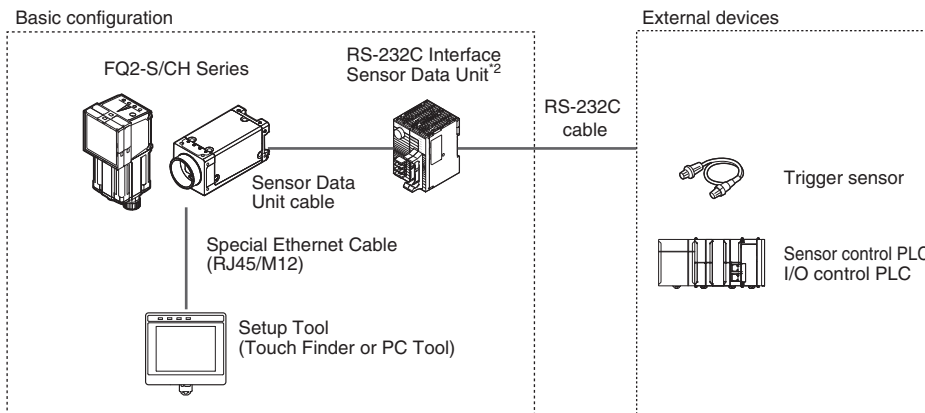

*2: A parallel cable (FQ-SDU2 special-purpose cable) can be used to connect to external devices from the Sensor Data Unit. In this case, an ACK signal can be used as an additional output signal.

1-2 Communicating with an External Device

FQ2-S1

FQ2-S2

FQ2-S3

FQ2-S4

FQ2-CH

This section gives the communications specifications, describes the control methods that you can use for communications, and describes the settings that are required before starting communications with an external device.

Basic Control Operations of the Sensor

The following figure shows basic communications between an external device and the Sensor and the flow of signals and data.

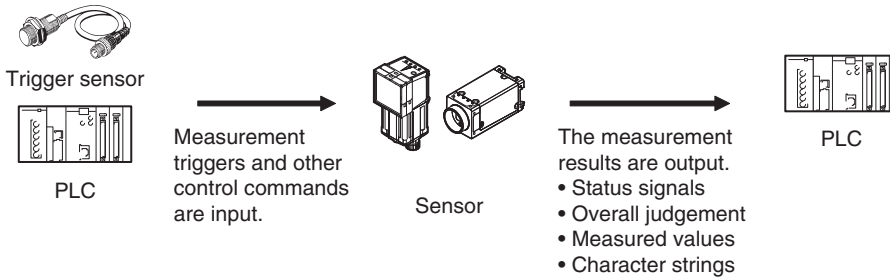

The following methods can be used to exchange data between an external device and the Sensor.

Commands That Can Be Input to the Sensor from an External Device

Type	Description
Control commands	Control signals (input signals)
	Control signals (input signals)
	Communications command input

A measurement is executed when a measurement trigger (i.e., an ON TRIG signal) is input. For information on control signals, refer to Control with Control Signals and Status Signals: p.18.

Various commands can be executed, such as measuring commands and scene change. The communications commands depend on the communications protocol that you use. Refer to the section for each communications protocol for details.

Data Output to an External Device from the Sensor

Type	Description
Status signals	When the Sensor confirms a control signal or communications command input and begins measurement processing, the status of the Sensor is reported to the external device through status signals (e.g., a BUSY signal). For information on status signals, refer to Control with Control Signals and Status Signals: p.18.
Overall judgement	NG is output whenever there is one or more NGs in the judgement results for multiple inspection items.*1 The overall judgement can be output through the OR signal or through the JG output parameter. *1: This behavior can be changed in the settings. For information on the OR signal, refer to Control with Control Signals and Status Signals: p.18. For information on the JG output parameter.
Measured values	The measured values from inspection items can be output. The output items must be inspection items for output and registered as output data (data 0 to data 31). Refer to the following for details. Settings Required for Data Output: p.61, 97, 124, 148, 169, 198. You can also use commands to obtain results after a measurement is performed.

Type	Description
Character output (FQ2-S4/CH series only)	You can output character strings and numbers that are read by inspection items such as OCR, Barcode, 2D-code, or 2D-code (DPM). Refer to  Items That Can Be Output as Output Data: p.22 for details. You can also use commands to obtain results after a measurement is performed.

Control Methods for the Sensor

There are three methods that you can use to control the Sensor from a PLC or other external device. They are described in this section.

For details on each control method, refer to their corresponding section.

Control Methods

Method	Overview	Trigger type or area	Signals or area used
Control signals and status signals	Operation is controlled by the ON/OFF status of the Measurement Trigger Signal (TRIG) and Command Request Bit (EXE).	ON/OFF status of the control signals and status signals	Control signals and status signals
Control with commands and responses	Control is performed by sending control commands. The execution results of the command can be confirmed in the response from the Sensor.	The control command code is stored in the I/O memory of the PLC and then the Request Bit is turned ON.	PLC I/O memory (Command Area and Response Area)
Data output after measurements	After a measurement is performed, the previously specified measurement data is output automatically.	Not required. (Output is performed automatically after measurement.)	PLC I/O memory (Data Output Area)

1 Control with Control Signals and Status Signals (Refer to Control with Control Signals and Status Signals: p.18)

Control and status confirmation for the Sensor is performed with the ON/OFF status of the control and status signals.

This method is best suited for basic operations such as measurement triggers or to check the operating status of the Sensor.

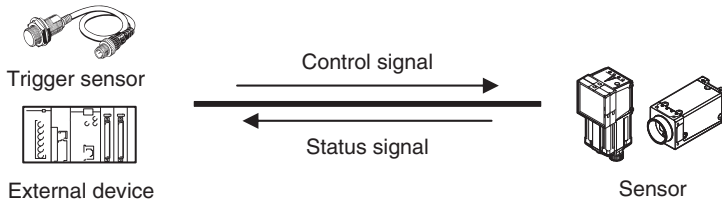

2 Command/Response Method (Refer to Command/Response Method: p.20)

Control is performed by storing the control command and the response to that command in the I/O memory of a PLC.

This method is best suited to send multiple commands to the Sensor without using PLC communications instructions.

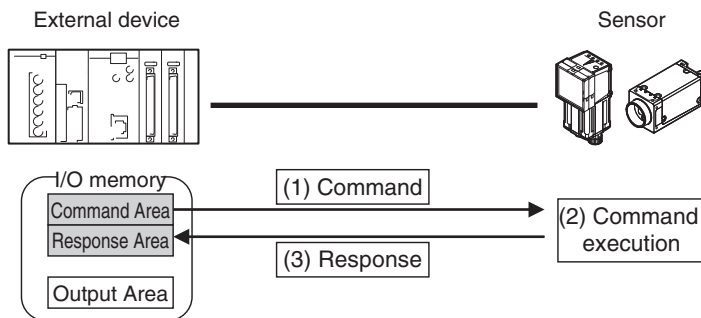

3 Data Output after Measurements (Refer to Data Output after Measurements: p.21)

After a measurement is executed, the measurement data specified for output is automatically output to the specified words in the I/O memory of the PLC.

This is suited to reception of the measurement result data of each inspection item.

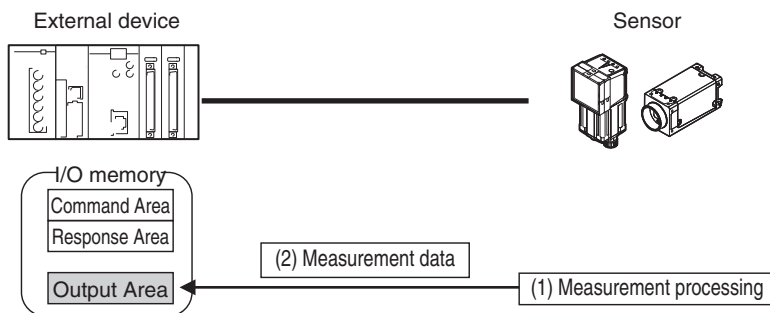

Communication Protocols for Communication with the Sensor

The Sensor can be controlled from a PLC, computer, or other external device using a variety of communication protocols.

The communication protocols that can be used to control the Sensor from an external device are described below.

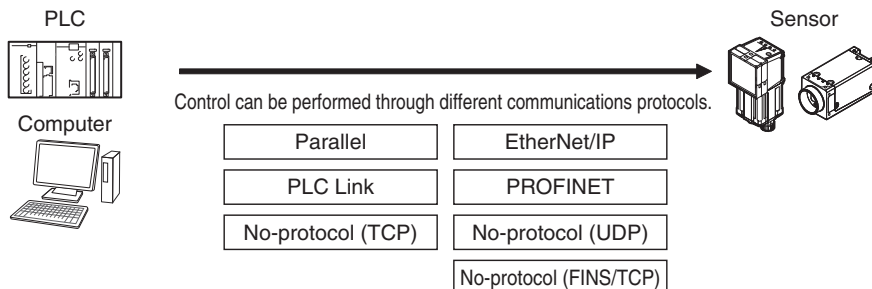

Applicable Communications Protocols

The communication protocols of each communication method that can be used with the Sensor are as follows:

OK: Supported, ---: Not supported.

Communi- cations method	Communi- cations protocol	Overview	Communications cable type		
			Parallel I/O	Ethernet	RS-232C
Contact inputs	Parallel	Data is exchanged between an external device and the Sensor through combinations of ON/OFF signals from multiple physical contacts.	OK	---	OK ^{*2}
Data shar- ing	PLC Link	This is OMRON's communications protocol for Vision System. The control signals, Command Area/Response Area, and area to store measurement data are assigned in the I/O memory of the PLC, and data is exchanged cyclically to share data between the PLC and the Vision System.	---	OK	---
	EtherNet/IP	This is an open communications protocol. Tag data links are used for communication with the Sensor. On the PLC, structure variables are created that correspond to the control signals, command/response data, and measurement data. These variables are then used as tags to input and output data through tag data links to exchange data between the PLC and the Sensor. ^{*1}	---	OK	---
	PROFINET	This is an open communications protocol. RT (Real-time) of soft real-time communication (SRT) is used for communication with the Sensor. The control signals, Command Area/Response Area, and area to store measurement data are assigned in the I/O memory of the PLC, and data is exchanged cyclically to share data between the PLC and the Vision System.	---	OK	---
Frame transmis- sion	No-protoc- ol (TCP) No-protoc- ol (UDP)	Command frames are sent to the Sensor and response frames are received from the Sensor without the use of any specific protocol. Data can be exchanged between the PLC, computer, or other external device and the Sensor by sending and receiving ASCII or binary format data.	---	OK	---
	No-protoc- ol (FINS/ TCP)	This is a command system (FINS) for message services that can be used in common on OMRON networks. Data can be exchanged between an OMRON PLC and the Sensor by a command/response method.	---	OK	---

*1: When connected to a CJ-series PLC, specify the areas in the I/O memory.

*2: This connection is via the RS-232C Interface Sensor Data Unit. Only supported on the FQ2-S3/S4/CH series.

Connection Compatibility

Yes: Supported, No: Not supported

Type of connection to FQ2-S/CH		Other connection							
		EtherNet/IP	PLC Link on Ethernet	PROFINET	TCP no-protocol communications on Ethernet, UDP no-protocol communications on Ethernet	FINS/TCP no-protocol communications on Ethernet	RS-232C ^{*1}	Parallel communications	
								Sensor's standard parallel communications	Parallel Interface ^{*2}
EtherNet/IP		---	No	No	Yes	Yes	Yes	Yes	Yes
PLC Link on Ethernet		No	---	No	Yes	Yes	Yes	Yes	Yes
PROFINET		No	No	---	Yes	Yes	Yes	Yes	Yes
TCP no-protocol communications on Ethernet, UDP no-protocol communications on Ethernet		Yes	Yes	Yes	---	No	No	Yes	Yes
FINS/TCP no-protocol communications on Ethernet		Yes	Yes	Yes	No	---	No	Yes	Yes
RS-232C ^{*1}		Yes	Yes	Yes	No	No	---	Yes	No
Parallel communications	Sensor's standard parallel communications	Yes	Yes	Yes	Yes	Yes	Yes	---	No
	Parallel Interface ^{*2}	Yes	Yes	Yes	Yes	Yes	No	No	---

*1: This applies when an RS-232C Interface Sensor Data Unit is connected.

*2: This applies when a Parallel Interface Sensor Data Unit is connected.

Note

Connections Across Network Routers

You can connect to a Sensor on a different network than the Touch Finder or PC Tool through a router.

- To connect to a Sensor, directly specify the IP address of the Sensor. Automatic connection to a Sensor is not possible.
- Use a fixed IP address for the Sensor to connect to.

Models That Are Compatible with the Communications Protocols

This section lists the external devices that can communicate with the FQ2-S/CH series for each communications protocol.

PLC Link

OMRON

○: Can connect △: Only some models can connect X: Cannot connect

Series	CPU Unit	Interface	
		Direct connection with CPU unit (built-in port)	Connection via Ethernet unit
SYSMAC_CJ2	CJ2H or CJ2M	△ (Built-in port only.)	CJ1W-EIP21 (PLC Link only) or CJ1W-ETN21
SYSMAC_CJ1	CJ1H or CJ1G	X	CJ1W-EIP21 (PLC Link only) or CJ1W-ETN21
	CJ1M	△ (Built-in port only.)	CJ1W-EIP21 (PLC Link only) or CJ1W-ETN21
SYSMAC_CS	CS1H, CS1D, or CS1G	X	CS1W-EIP21 (PLC Link only) or CS1W-ETN21
SYSMAC_CP1	CP1L	△ (Built-in port only.)	---
	CP1H	X	CJ1W-EIP21 (PLC Link only) or CJ1W-ETN21
SYSMAC_One	NSJ	X	NSJW-ETN21

Mitsubishi Electric

○: Can connect △: Only some models can connect X: Cannot connect

Series	Model name	CPU Unit	CPU name	Interface	
				Direct connection with CPU unit (built-in port)	Connection via Ethernet unit
MELSEC-QnU	Universal models	QnUDECPU	Q03UDECPU, Q04UDEHCPU, Q06UDEHCPU, Q10UDEHCPU, Q13UDEHCPU, Q20UDEHCPU, or Q26UDEHCPU	○	QJ71E71-100, Q71E71-B2, or QJ71E71-B5
		QnUDCPU	Q03UDCPU, Q04UDHCPU, Q06UDHCPU, Q10UDHCPU, Q13UDHCPU, Q20UDHCPU, or Q26UDHCPU	X	
		QnUCPU	Q00UJCPU, Q00UCPU, Q01UCPU, or Q02UCPU,	X	
	Basic models	QnCPU	Q00JCPU, Q00CPU, or Q01CPU	X	
MELSEC-Q Series	High-performance models	QCPU	Q02CPU, Q02HCPU, Q06HCPU, Q12HCPU, or Q25HCPU	X	

Series	Model name	CPU Unit	CPU name	Interface	
				Direct connection with CPU unit (built-in port)	Connection via Ethernet unit
MELSEC-QnAS Series	---	---	Q2ASCPU, Q2ASCPU-S1, Q2ASHCPU, or Q2ASHCPU-S1	X	A1SJ71QE71N3-T

EtherNet/IP

○: Can connect △: Only some models can connect X: Cannot connect

Series	CPU Unit	Interface	
		Direct connection with CPU unit (built-in port)	Connection via EtherNet/IP unit
SYSMAC NJ	NJ501 or NJ301	○	CJ1W-EIP21
SYSMAC_CJ2	CJ2M or CJ2H	△ (Built-in port only.)	CJ1W-EIP21
SYSMAC_CJ1	CJ1H or CJ1G	X	CJ1W-EIP21
	CJ1M	△ (Built-in port only.)	CJ1W-EIP21
SYSMAC_CS	CS1H, CS1D, or CS1G	X	CS1W-EIP21

No-protocol (TCP), No-protocol (UDP)

OMRON

Series	CPU Unit	Interface	
		Direct connection with CPU unit (built-in port)	Connection via Ethernet unit
SYSMAC CJ2	CJ2H or CJ2M	---	CJ1W-ETN21
SYSMAC CJ1	CJ1H or CJ1G	---	CJ1W-ETN21
	CJ1M	---	CJ1W-ETN21
SYSMAC CS	CS1H, CS1D, or CS1G	---	CS1W-ETN21
SYSMAC CP1	CP1L	△ (Built-in port only.)	---
	CP1H	---	CJ1W-ETN21
SYSMAC One	NSJ	---	NSJW-ETN21

No-protocol (FINS/TCP)

OMRON

Series	CPU Unit	Interface	
		Direct connection with CPU unit (built-in port)	Connection via Ethernet unit
SYSMAC CJ2	CJ2H or CJ2M	△ (Built-in port only.)	CJ1W-EIP21 or CJ1W-ETN21
SYSMAC CJ1	CJ1H or CJ1G	---	CJ1W-EIP21 or CJ1W-ETN21
	CJ1M	△ (Built-in port only.)	CJ1W-EIP21 or CJ1W-ETN21
SYSMAC CS	CS1H, CS1D, or CS1G	---	CS1W-EIP21 or CS1W-ETN21

Series	CPU Unit	Interface	
		Direct connection with CPU unit (built-in port)	Connection via Ethernet unit
SYSMAC CP1	CP1L	△ (Built-in port only.)	---
	CP1H	---	CJ1W-ETN21
SYSMAC One	NSJ	---	NSJW-ETN21

1-3 Control Methods Using an External Device

FQ2-S1

FQ2-S2

FQ2-S3

FQ2-S4

FQ2-CH

This section describes the methods that you can use to control the Sensor from a PLC or other external device.

Control with Control Signals and Status Signals

Control and status confirmation for the Sensor is performed with the ON/OFF status of the control and status signals.

Measurement triggers and other signals are input as control signals from the PLC.

The operating status of the Sensor, judgement results, and other status information can be confirmed through status signals sent from the Sensor.

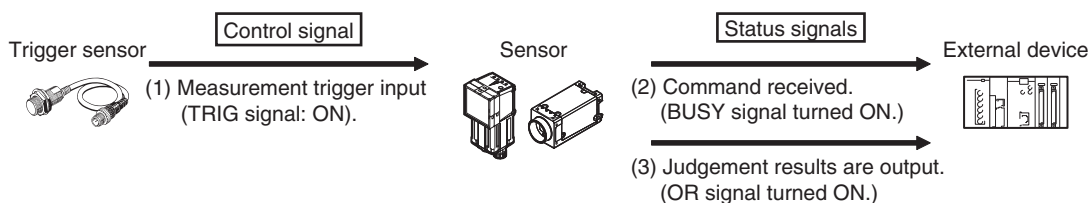

- (1) The external device turns ON the TRIG signal to input a measurement trigger.
- (2) When the Sensor confirms that the TRIG signal is ON, it outputs the BUSY signal to the external device and begins a measurement.
- (3) When the Sensor finishes the measurement, it outputs the judgement results on the OR signal.

Control Signals and Status Signals

The types of signals that are input to and output from the sensor as control signals and status signals are shown below. “Use of signal in each protocol” in the table below lets you check whether or not a signal is used in each protocol.

Note that this table does not show whether simultaneous use of signals in differing communication protocols is possible. For restrictions on communication protocols that can be used simultaneously, refer to

Connection Compatibility on page 14.

Input Signals (PLC to Sensor)

Signal	Signal name	Function	Signals for each communications protocol			
			Parallel	PLC Link	EtherNet/IP	PROFINET
EXE	Control Command Execution Signal	Turn ON this signal (from the PLC) to send a command to the FQ-S/CH series.	---	OK	OK	OK
TRIG	Measure Bit	Turn ON this signal to execute measurement.	OK	---	OK	OK
DSA (Used only for handshaking output control.)	Data Output Request Signal	Use this signal (from the PLC) during handshaking to request from the FQ-S/CH series the external output of the data output results.	OK	OK	OK	OK
ERCLR	Error Clear Bit	Turn ON this signal to clear the ERR signal from the Sensor Controller.	---	---	OK	OK

Signal	Signal name	Function	Signals for each communications protocol			
			Parallel	PLC Link	EtherNet/IP	PROFINET
IN (IN0 to IN7)	Command Input Signals	These signals are used to input commands from a parallel interface.	OK	---	---	---

Output Signals (Sensor to PLC)

Signal	Signal name	Function	Signals for each communications protocol			
			Parallel	PLC Link	EtherNet/IP	PROFINET
BUSY	Busy Signal	This signal tells when new commands and other external inputs cannot be acknowledged during processing of other external inputs. ^{*1} Just because this signal is ON does not necessarily mean that a command is being executed. To check whether a command is being executed, access the Command Completion (FLG) signal.	OK	OK	OK	OK
FLG	Control Command Completion Signal	The FQ2-S/CH series uses this signal to tell the user (PLC) that command execution has been completed.	---	OK	OK	OK
GATE	Data Output Completion Signal	This signal tells the user (PLC) when to read the measurement results. Data output is enabled when this signal is ON. ^{*2}	OK	OK	OK	OK
READY	Camera Image Input Enabled Signal	This signal tells when the TRIG (Measurement Trigger) signal can be input.	---	---	OK	OK
OR	Overall Judgement Output Signal	This signal gives the results of the overall judgement. ^{*5}	OK	---	OK	OK
DO (DO0 to DO15)	Data Output Signals	These signals are used to output parallel data and parallel judgements through a parallel interface sensor data unit.	OK	---	---	---
ERR	Error Signal	<p>The FQ2-S/CH series provides notification with this signal when it detects the following errors. Refer to  Section 8 Troubleshooting in Vision Sensor FQ2-S/CH User's Manual (Cat. No. Z337).</p> <ul style="list-style-type: none"> • Communication timeout • TRIG Input while measurement <p>The ERR signal does not turn OFF even after the error is eliminated. The signal turns OFF only when the error status is cleared by a control command.</p>	OK	OK	OK	OK

Signal	Signal name	Function	Signals for each communications protocol			
			Parallel	PLC Link	EtherNet/IP	PROFINET
RUN	Measurement Mode Signal	The FQ2-S/CH series turns ON this signal when measurements can be performed and it is in Run Mode.	OK	---	OK	OK
ACK	Command Completion Flag	This signal tells when execution of the DI command has been completed.	OK	---	---	---
SHTOUT	Exposure Completion Signal	This signal tells when Camera exposure has been completed.	OK	---	---	---
STGOUT	Strobe Trigger Output	This is the trigger signal for the strobe.	OK	---	---	---

- *1: The execution of commands or other processing received through any other protocol cannot be detected. The parallel BUSY signal can be used in all protocols. If you use more than one protocol and need to detect command execution, use the parallel communications BUSY signal.
- *2: This signal is linked to the measurement processing. It is not associated with the BUSY signal. It is not related to the parallel interface OR signal.

Command/Response Method

Parallel

Commands are input to the Sensor by turning the IN signals (Standard Parallel: IN0 to IN5, Parallel Interface Sensor Data Unit: IN0 to IN7) ON and OFF. There is no direct response to these commands. Confirm whether a command was received by checking the BUSY signal.

The command code is input with part of the IN signals (Standard Parallel: IN0 to IN4, Parallel Interface Sensor Data Unit: IN0 to IN6), and the command is executed by turning ON the execution bit (Standard Parallel: IN5, Parallel Interface Sensor Data Unit: IN7).

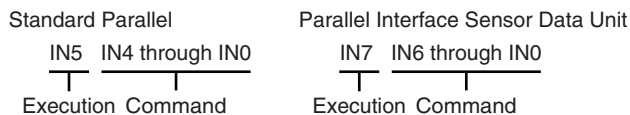

PLC Link, EtherNet/IP, or PROFINET

Command/response control signals can be exchanged by storing control commands from the PLC to the Sensor and responses from the Sensor to the PLC in the I/O memory of the PLC. This enables you to send single measurement and scene switch requests to the Sensor without any sequence control with communications commands from the PLC.

Memory Areas Used by the Command/Response Control Method

Command Area	You write the control commands to execute for the Sensor to this area.
Response Area	You read the results of executing the control commands that were written to the Command Area from this area.

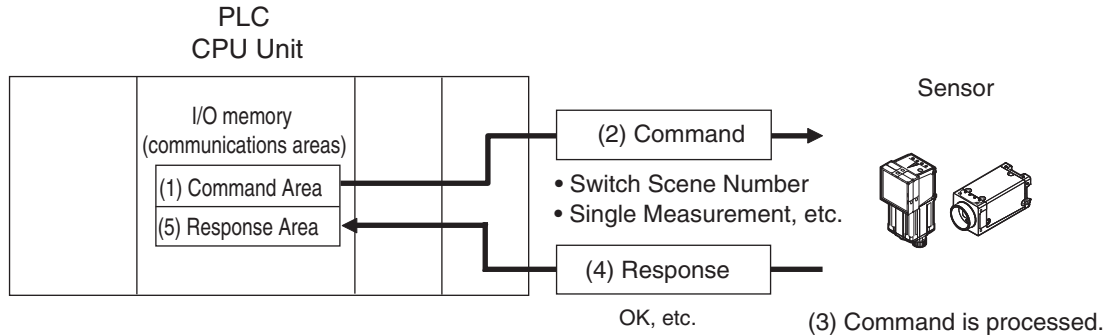

Flow of Communications between the PLC and the Sensor

- The PLC (the user) writes a control command to a specified PLC I/O memory area (the Command Area).
 Parameter Notation Examples for Command Control: p.200
- The PLC (the user) then turns ON the EXE bit to send the control command to the Sensor.
- The Sensor executes the received control command.
- The Sensor returns a response to the PLC after the control command is executed.
- The PLC (the user) stores the response in a specified PLC I/O memory area (the Response Area).

The available control commands depend on the communications protocol that is used.

Command List: p.202.

No-protocol (TCP) Communications, No-protocol (UDP) Communications, No-protocol (FINS/TCP) Communications

Communications commands are sent to the Sensor through sequence control in the PLC. An external device and the Sensor communicate through no-protocol communications.

Data Output after Measurements

After a Single Measurement or Start Continuous Measurements command is executed, the Sensor automatically outputs the data that corresponds to the measurements that have been specified as output items to the PLC. This allows you to easily pass measurement results data from the inspection items to the PLC. You can also choose to output only when the PLC meets the conditions that are required to receive the data (i.e., when handshaking is turned ON).

The output destination for data depends on the protocol that is used to communicate between the external device and the Sensor, as described below.

PLC Link, EtherNet/IP, or PROFINET

The output data is automatically output to the following area that is specified PLC I/O memory.

Area of Memory Used for Data Output after Measurement

Data Output Area	The output data for the measurement is written to this area by the Sensor after execution of the measurement.
------------------	---

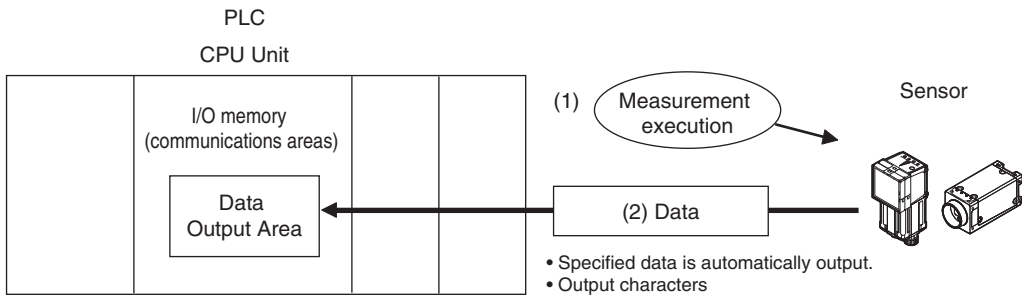

Flow of Communications between the PLC and the Sensor

The data to output after measurement and the PLC I/O memory area (Data Output Area) to store that data are specified in advance. (Setting Required for Data Output: p.61, 97, 124, 148, 169, 198.)

- (1) Measurement is executed.
- (2) After a measurement is executed, the specified measurement data is stored in the Data Output Area in the PLC.

Parallel

A Parallel Interface Sensor Data Unit can be installed to enable data output. The output data is output to the PLC signal wires via the D signals (D0 to D15). This is only supported on the FQ2-S4/CH series.

No-protocol (TCP) Communications, No-protocol (UDP) Communications

The output data is output to the PLC reception buffer through non-procedure (normal) communications.

Items That Can Be Output as Output Data

Measurement Data

The following data items can be output by allocating measurement results and judgement results to output data 0 to output data 31.

- Judgement result
- Measured parameters (correlation values, reference coordinates, etc.)
- Results calculated based on the values of the measured parameters
- Judgement results from expression results (Parallel Judgement Output)

Character Output (This is Only Supported on the FQ2-S4/CH Series.)

After measurement, you can automatically output character strings that are read by OCR and other inspection items to the PLC. Character strings can be output for the following inspection items.

- OCR
- Bar code
- 2D-code
- 2D-code (DPM)

Number of Characters That Can Be Output

The number of characters that can be output are shown below for each inspection item.

- OCR: Max. 128 characters
- Bar code, 2D-code, 2D-code (DPM): Max. 1024 characters

For the character output setting procedures and output specifications for each communication type, refer to the following:



Outputting Character Strings

- EtherNet/IP: p.101
- PLC link: p.128
- PROFINET: p.151
- No-protocol (TCP), No-protocol (UDP): p.175

Note

- Endian
Little endian data is output.
- Code Conversion
The converted codes are outputted for the following character codes.

Character code	Before conversion	After conversion
CR	&h0D	&h8541
LF	&h0A	&h8542
DEL	&h7F	&h8543
FF	&hFF	&h8544

Order of Output of Measurement Data and Characters (Only Supported on the FQ2-S4/CH Series)

When measurement data the data (output data settings 0 to 31) and characters are output together, the characters are output after the data such as inspection item parameters and calculation results are output.

Example:

Read result 1: ABC

Read result 2: 0123

[Data output] – [Data 0]: 3 (Number of characters: 1)

[Data output] – [Data 1]: 4 (Number of characters: 2)

The following information will be output for the above.

EtherNet/IP, PLC Link, PROFINET

Increment from first address in output area	Output data		Assigned output data
	Upper byte	Lower byte	
+0	Data 0 (4 bytes)		Inspection item 0: Number of characters
+1			
+2	Data 1 (4 bytes)		Inspection item 1: Number of characters
+3			
+4	'B'	'A'	Inspection item 0: Characters "ABC"
+5	00	'C'	
+6	'1'	'0'	Inspection item 1: Characters "0123"
+7	'3'	'2'	
+8	00		Filled with zeros. (Only when the character string length is not a multiple of 4.)

No-protocol (TCP)

3 (Field delimiter) 4 (Record delimiter) ABC (Field delimiter) 0123 (Record delimiter) CR

CR is Delimiter, CR is not output by No-protocol (UDP) Communications.

Output Data Size and Number of Output Data Upper Value Setting (EtherNet/IP, PLC Link, PROFINET)

When more than one inspection result is output, the size of the data that is output for the data output settings could exceed the limit that is set in the [Max output data] (number of output data upper value) parameter setting.

If that occurs, increase the set value of the number of output data upper value setting or adjust the output data settings so that data output size is not exceeded.

If the size of the data that is output exceeds the data size that can actually be output (output data limit), the remaining data is handled as follows in each communication protocol.

- EtherNet/IP, PROFINET: The remaining data is divided and output over several cycles.
- PLC Link: The remaining data is discarded.

Example

Output data size: 328 bytes

Number of output data upper value setting: 256 bytes

Data Output Settings

Output data	Setting	
Data 0	I0.X[0]	Inspection item 0: Position X for Search
Data 1	I0.Y[0]	Inspection item 0: Position Y for Search
Data 2	LPC (0,30,I1.X,I1.Y)	Inspection item 1: Position X 1st point for Shape Search II
		Inspection item 1: Position X 30th point for Shape Search II
		Inspection item 1: Position Y 1st point for Shape Search II
		Inspection item 1: Position Y 30th point for Shape Search II
Data 3	LPR (0,10,I2.X,I2.Y)	Inspection item 2: Position X 1st point for Shape Search II
		Inspection item 2: Position Y 1st point for Shape Search II
		Inspection item 2: Position X 10th point for Shape Search II
		Inspection item 2: Position Y 10th point for Shape Search II

} 328 bytes

EtherNet/IP, PROFINET

The output data that is assigned is output to the output area as shown below.

Output data that exceeds the size (e.g., 256 bytes) that is set for the output data size parameter is separated over more than one cycle.

To ensure that no data is lost when receiving data that is divided and output over several cycles, use the handshake function.

 Data Output Control with Handshaking: p.30

Offset from first address in output area	Output data	Assigned output data	
+0	Output data 0 (4 bytes)	Inspection item 0: Position X for Search	256 bytes (Data that is output the first cycle.*1)
+1			
+2	Output data 1 (4 bytes)	Inspection item 0: Position Y for Search	
+3			
+4	Output data 2 (4 bytes)	Inspection item 1: Position X 1st point for Shape Search II	
+5			
⋮	⋮	⋮	
+62	Output data 31 (4 bytes)	Inspection item 1: Position X 30th point for Shape Search II	
+63			
+64	Output data 32 (4 bytes)	Inspection item 1: Position Y 1st point for Shape Search II	
+65			
⋮	⋮	⋮	
+122	Output data 61 (4 bytes)	Inspection item 1: Position Y 30th point for Shape Search II	
+123			
+124	Output data 62 (4 bytes)	Inspection item 2: Position X 1st point for Shape Search II	
+125			
+126	Output data 63 (4 bytes)	Inspection item 2: Position Y 1st point for Shape Search II	
+127			
+0	Output data 0 (4 bytes)	Inspection item 2: Position X 2nd point for Shape Search II	72 bytes (Data that is output the second cycle.*2)
+1			
⋮	⋮	⋮	
+12	Output data 6 (4 bytes)	Inspection item 2: Position X 10th point for Shape Search II	
+13			
+14	Output data 7 (4 bytes)	Inspection item 2: Position Y 10th point for Shape Search II	
+15			

*1: At the first data output, a GATE (Data Output Completion) signal is output.

*2: If the size of the specified output data exceeds the set value of the output data size setting, the data is output separately as shown below.

Output data size setting: 256 bytes

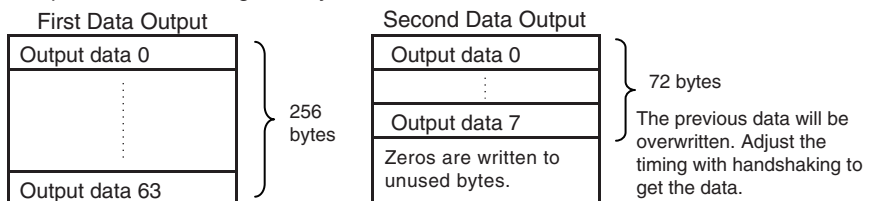



PLC Link

The output data that is assigned is output to the output area as shown below.

Any output data that exceeds the set value of the [Max output data] (number of output data upper value) parameter setting (e.g., 256 bytes) is discarded.

For the [Max output data] setting, refer to  Initial Settings for PLC Link Communications on page 122.

Offset from first address in output area	Output data	Assigned output data	
+0	Output data 0 (4 bytes)	Inspection item 0: Position X for Search	 <p>256 bytes (Data that is output the first cycle.)</p>
+1			
+2	Output data 1 (4 bytes)	Inspection item 0: Position Y for Search	
+3			
+4	Output data 2 (4 bytes)	Inspection item 1: Position X 1st point for Shape Search II	
+5			
⋮	⋮	⋮	
+62	Output data 31 (4 bytes)	Inspection item 1: Position X 30th point for Shape Search II	
+63			
+64	Output data 32 (4 bytes)	Inspection item 1: Position Y 1st point for Shape Search II	
+65			
⋮	⋮	⋮	
+122	Output data 61 (4 bytes)	Inspection item 1: Position Y 30th point for Shape Search II	
+123			
+124	Output data 62 (4 bytes)	Inspection item 2: Position X 1st point for Shape Search II	
+125			
+126	Output data 63 (4 bytes)	Inspection item 2: Position Y 1st point for Shape Search II	
+127			
+128	Output data 64 (4 bytes)	Inspection item 2: Position X 2nd point for Shape Search II	 <p>72 bytes (The data that exceeds the set upper limit is discarded.)</p>
+129			
⋮	⋮	⋮	
+160	Output data 65 (4 bytes)	Inspection item 2: Position X 10th point for Shape Search II	
+161			
+162	Output data 66 (4 bytes)	Inspection item 2: Position Y 10th point for Shape Search II	
+163			

Parallel Output of Measurement Data (Only Supported on the FQ2-S3/S4/CH Series)

When a Parallel Interface Sensor Data Unit is connected to the Sensor, the two types of data output below can be performed, in addition to output of measurement judgement results.

Output data type	Output data
Parallel Data Output	The measurement data is output. A maximum of 32 items can be output.
Parallel Judgement Output	The judgement results are output. A maximum of 16 judgement result items can be output. The following two types of judgement results can be output: <ul style="list-style-type: none"> • Judgement results for specified inspection items • Judgement results of set judgement conditions for the specified item values

Order of Parallel Data Output

Parallel Output of Multiple Items

Items set to output numbers 0 to 31 of parallel data output are output by item (4 bytes) in ascending order to the reception buffer of the PLC. The GATE signal turns OFF > ON^{*1} at each output.

When this occurs, the first data item that was output to the PLC reception buffer (data 0) is overwritten by the next output data item (data 1).

Therefore, the data output to the PLC reception buffer must be saved to PLC memory each time the GATE signal turns ON for each data item.

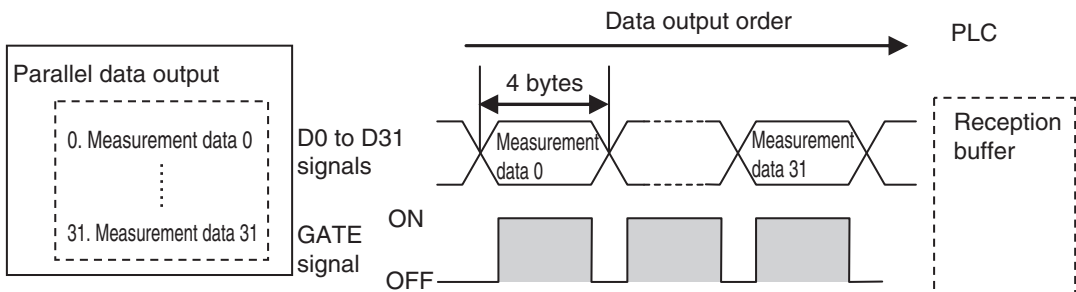

*1: The operation of the DSA signal depends on whether handshaking for output control is enabled. Data Output Control with Handshaking: p.30.

Data Output Timing

Output Sequence

If both parallel judgement output and parallel data output are performed at the same time, parallel judgement output will be performed first followed by parallel data output.

Example: Parallel Judgement Output of D0 to D15 and Parallel Data Output of Data 0

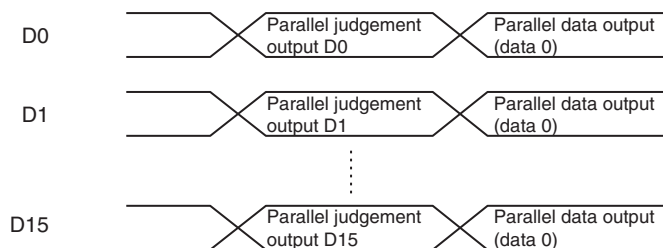

Timing Chart

The following timing chart shows the data output timing for parallel judgement outputs.

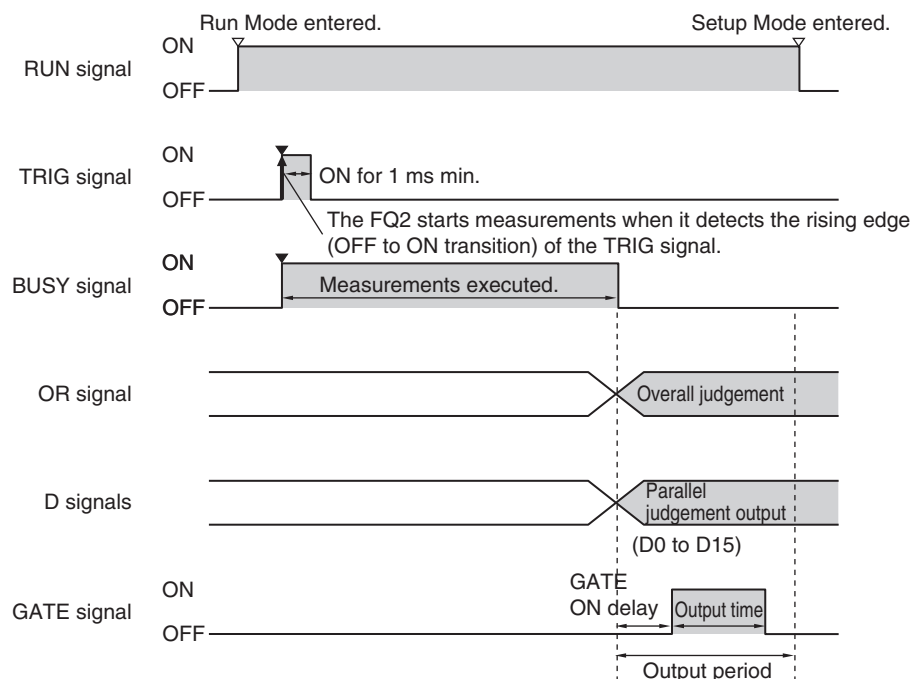

Output Signals

Signal	Function
RUN	This signal is ON while the Sensor is ready to take measurement and it is in Run Mode. The RUN signal is OFF in Setup Mode. Change to Run Mode for operation.
BUSY	This signal is ON when the Sensor is performing measurements, changing scenes, or performing other tasks. Do not input the next command while the BUSY signal is ON. The process that is currently being executed and the command that is input will not be executed correctly.
OR	This signal outputs the overall judgement. The signal is valid when the measurements are completed (i.e., when the BUSY signal changes from ON to OFF).
D	These signals output the parallel judgement output data and the calculation results of the expressions that are set for parallel data output. You can set whether the signal turns ON for an OK or for an NG judgement in the [Judgment output condition] output setting.  Changing the Judgement Output ON Conditions: p.44
GATE	This signal is used to control the timing of reading the D signals at an external device. It is turned ON for the period of time that is required to reliably read the D signals at the external device. Set the output period so that the total output time is shorter than the measurement interval (i.e., the TRIG signal input interval). The GATE signal is output only if parallel judgement output and parallel data output are set. The OR signal will be ON while the TRIG signal can be input.

Input Signals

Signal	Function
TRIG	This signal is used to input a measurement trigger from an external device, such as a photoelectric switch. One measurement is performed on the rising edge (OFF to ON transition) of the TRIG signal. Keep the TRIG signal ON for at least 1 ms.



Data Output Control with Handshaking

The timing for data output can be controlled through the DSA and GATE signals.

The handshake function can only be used with EtherNet/IP, PLC Link, PROFINET, and parallel communication (when a Sensor Data Unit is used).

Requirements for Using Data Output Control with Handshaking

To use data output control, set the output control method to [Handshaking] in the communications protocol settings. For details, refer to  *Communications Specifications Settings* for each communications protocol.

- Parallel Communications: Refer to  *Setting Data Communications Specifications*: p.66.
- PLC Link Communications: Refer to  *Setting Up PLC Link Communications*: p.122.
- EtherNet/IP and PROFINET Communications: Refer to  *Communications Specifications Settings* (p.92 or p.145).

Handshaking

If the external device does not turn ON the DSA signal, the measurement data will not be output to the external device from the Sensor.

While the DSA signal is ON, the GATE signal turns ON when the measurement data is output from the Sensor. The external device receives the measurement data when the GATE signal turns ON.

Signals Used for Handshaking

Signal	Name	Description
DSA	Data Output Request Signal	This signal is sent from the external device (PLC) to the Sensor to request data output.
GATE	Data Output Completion Signal	This signal is sent by the Sensor to the external device (PLC) to tell the PLC when to receive the output data. This signal is sent only while the DSA signal is ON.*1

*1: If handshaking is not enabled for output control, the GATE signal will also be turned ON when data is output from the Sensor.

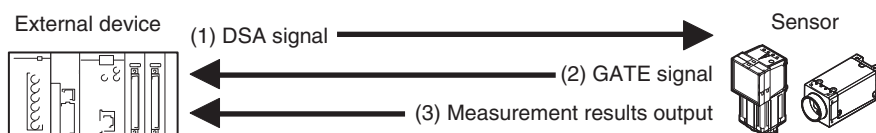

- (1) The PLC turns ON the DSA signal and waits for the output data.
- (2) The Sensor turns ON the GATE signal when the DSA signal is ON and it is ready to output the measurement results.
- (3) The Sensor turns ON the GATE signal and outputs the output data.

Receiving Divided Output Data (Using EtherNet/IP)

In EtherNet/IP, if the data size of the set output data exceeds the data size that the Sensor can actually output in one cycle (256 bytes), the data is divided and output over multiple cycles.

In this case, use handshaking as shown below to receive the multiple cycles of output data.

Example: EtherNet/IP Communications with Handshaking

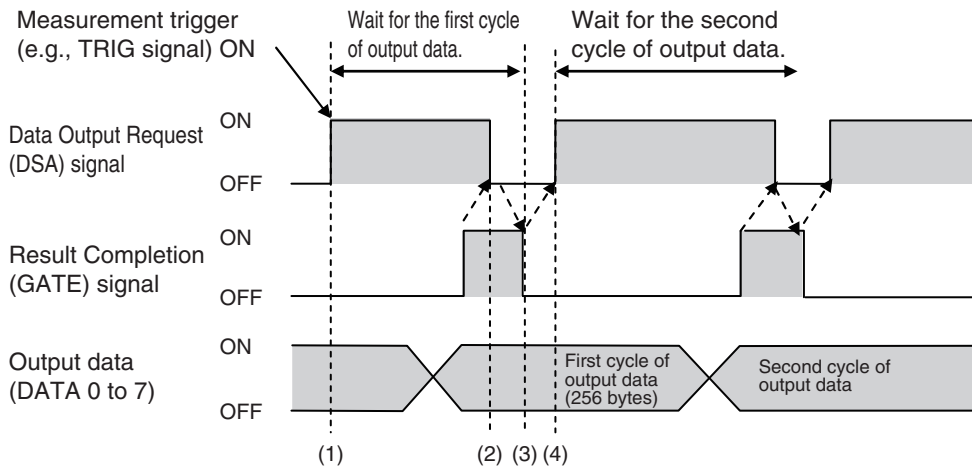

- 1** When the first data is received, the user (PLC) turns ON the measurement trigger and the DSA signal.
- 2** The Sensor turns ON the GATE signal when the DSA signal is turned ON and outputs the first data.
- 3** The user (PLC) turns OFF the DSA signal again when the GATE signal turns ON. Then, the user (PLC) confirms the output data received in the PLC Data Output Area and moves the received data to another area in PLC I/O memory.
- 4** The Sensor confirms that the DSA signal is OFF and automatically turns OFF the GATE signal.
- 5** When reception of the output data is completed and the GATE signal turns OFF, the user (PLC) turns on the DSA signal again and waits for the second cycle of data which could not be sent in the first cycle and was divided.
- 6** When the second data is output, the second data output is received when the GATE signal is turned ON and steps 3 and 5 above are repeated.

Steps 3 through 5 above are repeated for all subsequent data output items.

MEMO

Controlling Operation and Outputting Data with a Parallel Connection

2-1 Controlling Operation and Outputting Data with the Sensor's Standard Parallel Connection	34
2-2 Controlling Operation and Outputting Data with a Parallel Interface Sensor Data Unit.....	60

2-1 Controlling Operation and Outputting Data with the Sensor's Standard Parallel Connection

This section explains how to directly connect the Sensor to external devices with the I/O cable, and control the Sensor and execute output.

Basic Operation with a Parallel Connection

This section describes the basic connections and signal flow with external devices. With the default settings, the Sensor operates in the following manner.

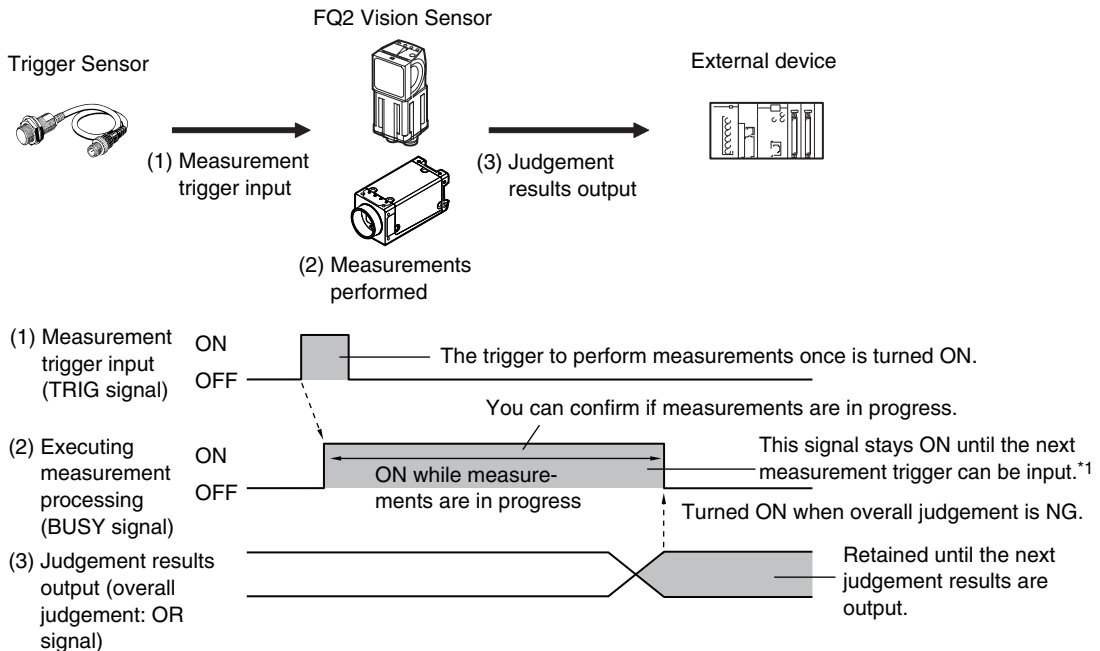

*1: You can also use the READY signal, which will turn ON when a measurement trigger can be input. You can assign the READY signal to any output from OUT0 to OUT2.
 Getting Individual Judgements and Expression Judgements: p. 41

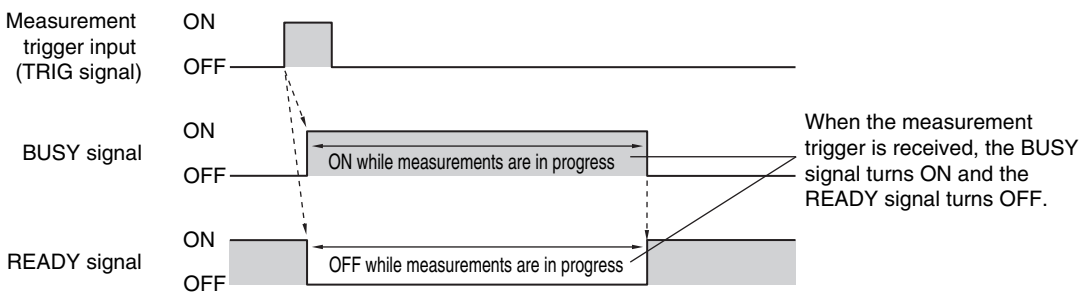

Important

- Create the ladder program to control the TRIG and IN5 input signals so that they do not turn ON while the BUSY signal is ON. If not, a TRIG input error will occur and the ERROR signal will turn ON.
- Operation When the Sensor Power Supply Is Turned ON

The BUSY signal will operate as shown below when the Sensor's power supply is turned ON.

Create the ladder program in the PLC or other external device so that the BUSY signal is ignored while it turns OFF, ON, and OFF again for up to 5 s after the power supply is turned ON.

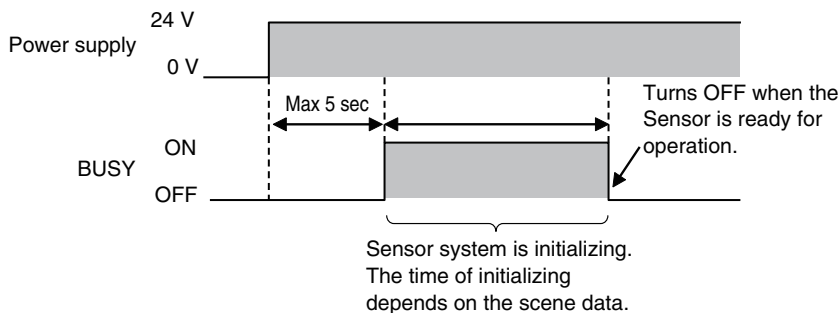

Note

You can mount a Parallel Interface Sensor Data Unit to enable using other signals and increase the number of signals that you can use with parallel communications. And in addition to outputting OR judgement results, you can also use a Parallel Interface Sensor Data Unit to output the judgement results of judgement conditions that you set for parallel output (called parallel judgement output) and the results of measurement values and expressions for inspection items (called parallel data output).

Controlling Operation and Outputting Data with a Parallel Interface Sensor Data Unit: p. 60

Configuring the Operation

The following settings can be selected depending on the system configuration and application.

Type of change	Change	Reference
Changing the type of measurement trigger	Performing continuous measurements	p. 37
Changing the output method of the judgement results	Obtaining individual judgement results	p. 41
	Adjust the judgement output timing	p. 42
	Changing the judgement output ON conditions	p. 44
Changing the polarity of the BUSY output	Reversing the polarity of the BUSY signal	p. 44
Changing the BUSY output condition	Adjusting the end timing of the BUSY signal	p. 45
Changing the polarity of the output signals (OUT1 to OUT2)	Reversing the output polarity of OUT1 to OUT2	p. 45
Selecting the types of commands that can be used	Changing the commands used in IN0 to IN5	p. 45

Setting the Measurement Trigger

The measurement trigger can be chosen from the following two types:

- One-shot measurement: One measurement is performed for each external trigger.
- Continuous measurement: Measurements are performed continuously.

Performing One Measurement for Each External Trigger

A measurement trigger is input as the TRIG signal from a proximity sensor, PLC, or other external device. One measurement is performed when the TRIG signal turns ON.

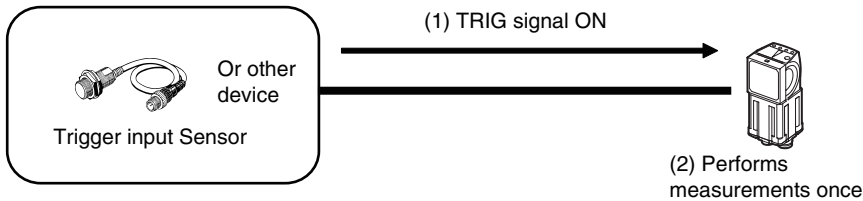

Wiring

Color	Signal	Description
Pink	TRIG	Trigger signal
Black	OUT0 (OR)	Overall judgement (default assignment)
Orange	OUT1 (BUSY)	Processing in progress (default assignment)

The signals shown at the left are used. Refer to the following information for signal wiring.



Section 2 Installation and Connections in Vision Sensor FQ2-S/CH Series User's Manual (Cat. No. Z337)

Timing Chart

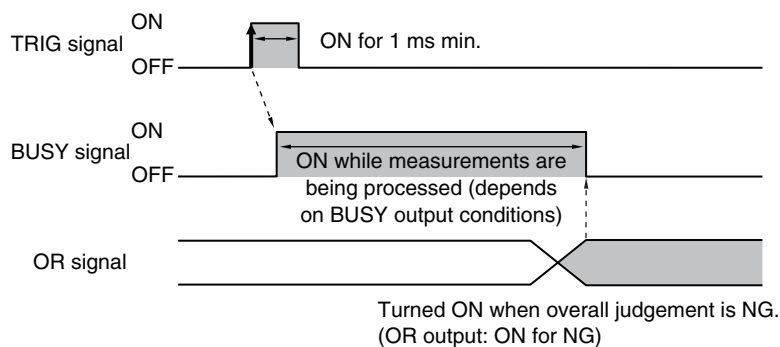

1. Turn ON the TRIG signal while the BUSY signal is OFF.
2. Measurement begins and the BUSY signal is turned ON during the measurement process.
3. When the measurement has been finished, the measurement result is output using an OR signal, and the BUSY signal is turned OFF. *1

*1: You can also set the signal to be turned OFF after data logging, image logging, or displaying results in the [BUSY output].

Important

When the Brightness Correction Mode is ON, the timing when images are taken is delayed.



Section 3 Taking Images in Vision Sensor FQ2-S/CH Series User's Manual (Cat. No. Z337)

Sample Ladder Program

The following sample program is used to input a TRIG signal to perform a single measurement. A single measurement will be performed when W0.00 turns ON.

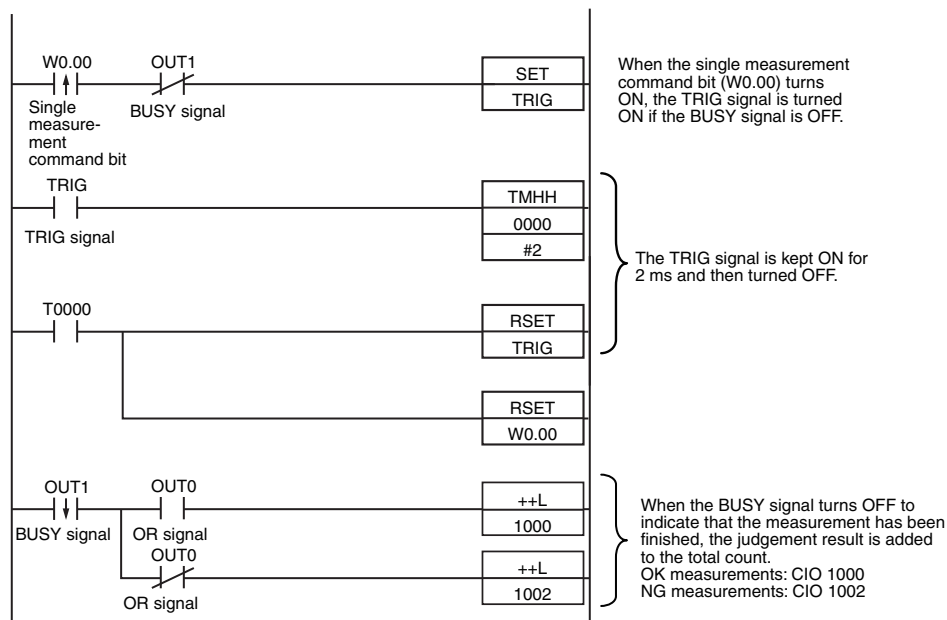

I/O Signal Allocations

Signal		Address
Output signals	OUT0 (OR signal)	CIO 0.00
	OUT1 (BUSY signal)	CIO 0.01
Input signals	TRIG	CIO 1.00

Important

The BUSY signal will remain ON while the measurement is being executed.

Performing Continuous Measurements

Continuous measurements are performed while the continuous measurement command is input from an external device.

Immediately after a measurement is performed, the next measurement is performed.

This is repeated while a continuous measurement command is input with the IN0 to IN5 signals.



Note

This function can be used only when the input mode is set to Expanded Mode.

 Changing the Types of Commands That Can Be Used: p. 45

Wiring

Color	Signal	State	Description
Gray	IN0	OFF	Command parameters for continuous measurements
Green	IN1	OFF	
Red	IN2	OFF	
White	IN3	OFF	
Purple	IN4	OFF	
Yellow	IN5	ON	Command input for continuous measurements
Black	OUT0 (OR)	--	Overall judgement (default assignment)
Orange	OUT1 (BUSY)	--	Processing in progress (default assignment)

The signals shown at the left are used. Refer to the following information for signal wiring.

 Section 2 Installation and Connections in Vision Sensor FQ2-S/CH Series User's Manual (Cat. No. Z337)

Timing Chart

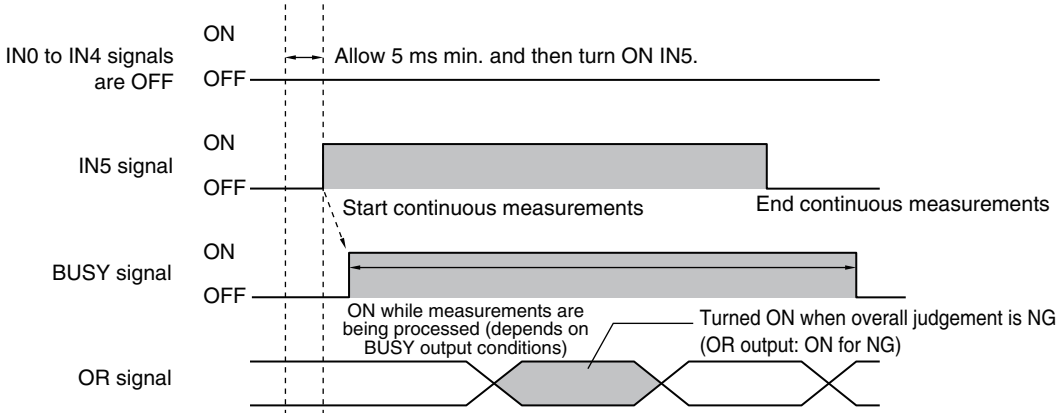

1. Turn ON IN5 while IN0 to IN4 are OFF. If status is held while the BUSY signal is OFF, continuous measurements will begin and the BUSY signal will remain ON while continuous measurements are being performed.
2. Continuous measurements end when IN5 is turned OFF.

Sample Ladder Program

The following sample program is used to input a IN5 signal to perform continuous measurements. Continuous measurements will be started when W0.00 turns ON and stopped when W0.01 turns ON.

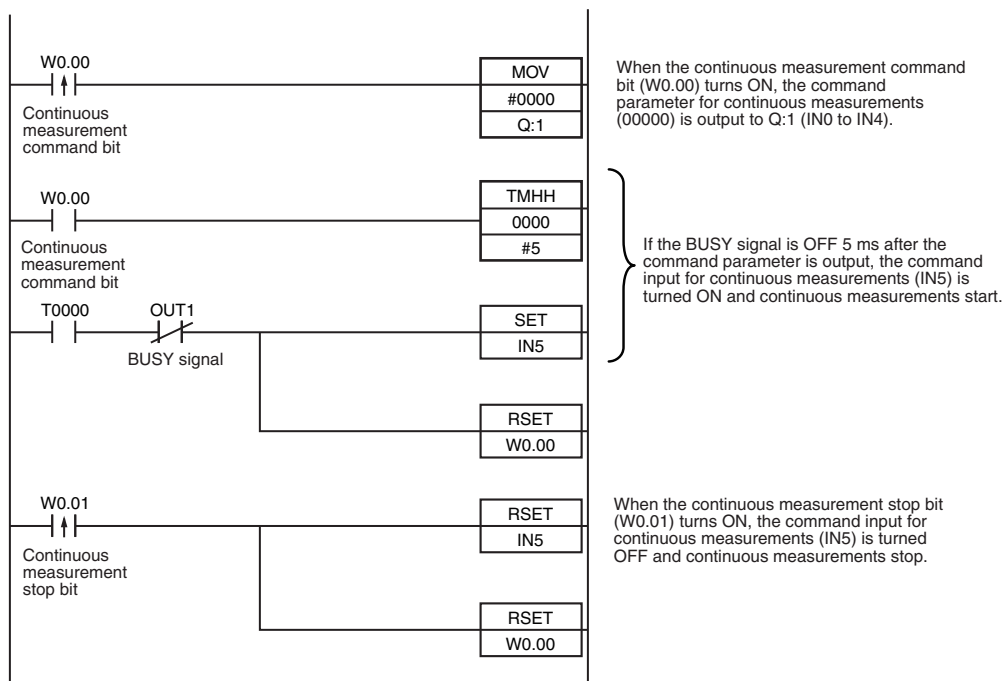

• I/O Signal Allocations

Signal		Address
Output signals	OUT1 (BUSY signal)	CIO 0.01
Input signals	IN0	CIO 1.08
	IN1	CIO 1.09
	IN2	CIO 1.10
	IN3	CIO 1.11
	IN4	CIO 1.12
	IN5	CIO 1.15

Setting the Outputs

Using the Overall Judgement Result

When the results of the inspection items are judged, if even one individual judgement result is NG, the OR output signal is turned ON.

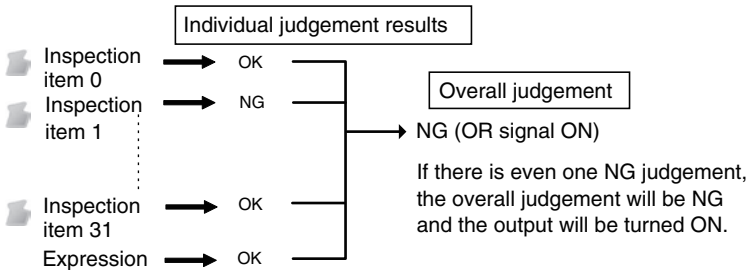

Note

- The overall judgement result output signal can also be turned ON when all individual judgement results are OK.
 - Changing the judgement output ON condition: p. 44
- You can select whether to include the judgement result of one of the expressions (0 through 31) in the overall judgement.
 - Section 4 Setting Up Inspections in Vision Sensor FQ2-S/CH Series User's Manual (Cat. No. Z337)
- You can adjust the timing for outputting the OR signal and the ON time after judgement processing.
 - Adjust the Judgement Output Timing: p. 42

Wiring

Color	Signal	Description
Black	OUT0 (OR)	Overall judgement (default assignment)

The signals shown at the left are used. Refer to the following information for signal wiring.

Section 2 Installation and Connections in Vision Sensor FQ2-S/CH Series User's Manual (Cat. No. Z337)

Timing Chart

The OR signal that is output is held until the next overall judgement is output.

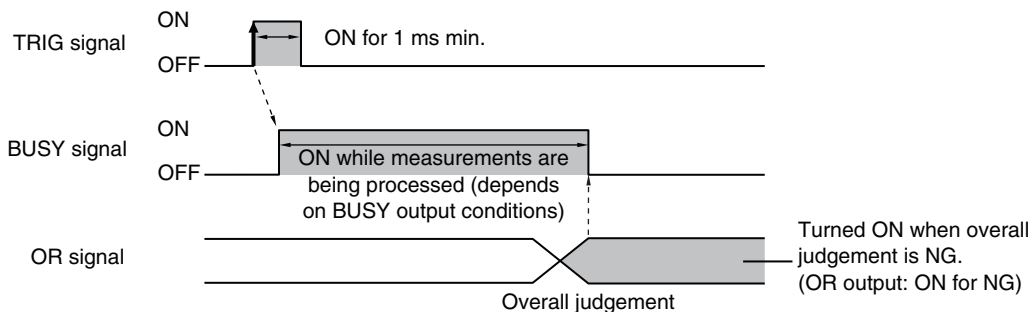

Note

The timing for updating the OR signal and the ON time after judgement processing can be adjusted.

 Adjusting the judgement output timing: p. 42

Getting Individual Judgements and Expression Judgements

Up to three judgement results of individual inspection items (item judgement signals OR0 to OR31) and expression judgements (expression 0 judgement to expression 31 judgement) can be assigned to terminals OUT0 to OUT2 and output to external devices.

Output terminal	Default assignment	Output signals that can be assigned
OUT0	OR (Total judgement)	<ul style="list-style-type: none"> Control signals: OR, BUSY, ERROR, READY, and RUN STG (strobe trigger) Item judgements: OR0 (Item 0 judgement) to OR31 (Item 31 judgement) Expression judgements: Expression 0 judgement to expression 31 judgement
OUT1	BUSY	
OUT2	ERROR	

Note

The timing for updating the OR0 to OR31 signals and the ON time after judgement processing can be changed.

 Adjusting the judgement output timing: p. 42

Important

During Sensor startup, the user output assignments of OUT1 and OUT2 output terminals are not effective. The output assignments assume the initial state and operate as follows.

- OUT1: Turns ON as a BUSY signal.

 Operation When the Sensor Power Supply Is Turned ON: p.34

- OUT2: Turns ON as an ERROR signal for about 20 ms immediately after sensor startup starts.

If you want to output a READY signal during Sensor startup, assign the READY signal to OUT0.

Wiring

Example: Signals are assigned to terminals OUT0 to OUT2 as shown below.

- OUT0: Item 2 judgement (OR2)
- OUT1: Item 5 judgement (OR5)
- OUT2: Item 14 judgement (OR14)

Color	Signal	Description
Black	OUT0 (OR2)	Outputs the judgement for OR2.
Orange	OUT1 (OR5)	Outputs the judgement for OR5.
Light blue	OUT2 (OR14)	Outputs the judgement for OR14.

The signals shown at the left are used. Refer to the following information for signal wiring.

 Section 2 Installation and Connections in Vision Sensor FQ2-S/CH Series User's Manual (Cat. No. Z337)

As described above, if terminals OUT0 to OUT2 are all assigned to individual judgement output signals, the BUSY signal and ERROR signal assigned as the default settings will no longer be output.

Timing Chart

Output OR0 to OR31 signals are held until the next judgement output.

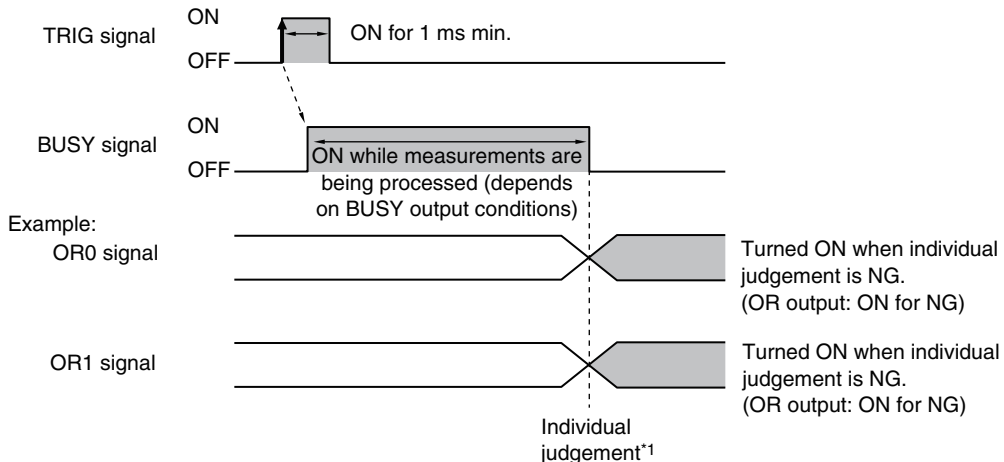

*1: The timing for updating the OR signal is when the measurement results are finalized, regardless of the output settings of the BUSY signal (BUSY output conditions).

Settings

▶ **[In/Out] – [I/O setting] – [I/O setting] – [Output]**

- 1** Press **[OUT0]**.
- 2** Press **[OR2 (Item 2 judgement)]**.
OR2 output signal was assigned to OUT0.
- 3** Assign the others in the following manner.
OUT1: OR5
OUT2: OR14

Adjusting the Judgement Output Timing

The output timing of the OR signal or OR0 to OR31 signals can be selected from two modes depending on the external device.

Selecting the OFF Timing

- Level output (default)

The status of the output OR signal is held until the next OR signal is output.

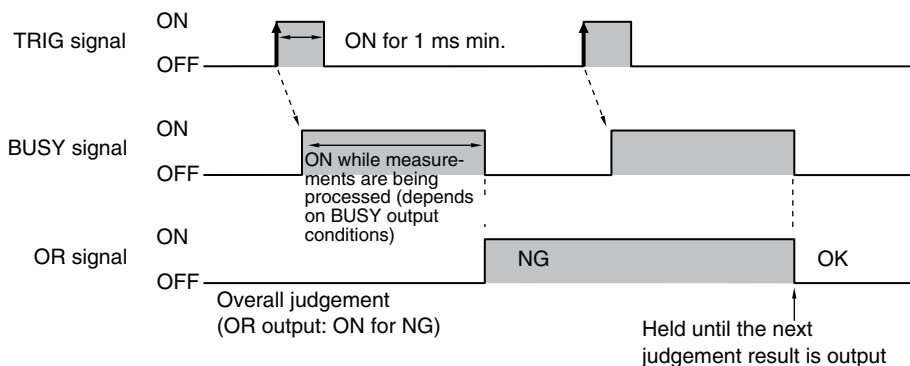

• One-shot output

The status of the output OR signal is turned OFF after a specified time has passed. (Setting range: 0 to 1,000 ms)

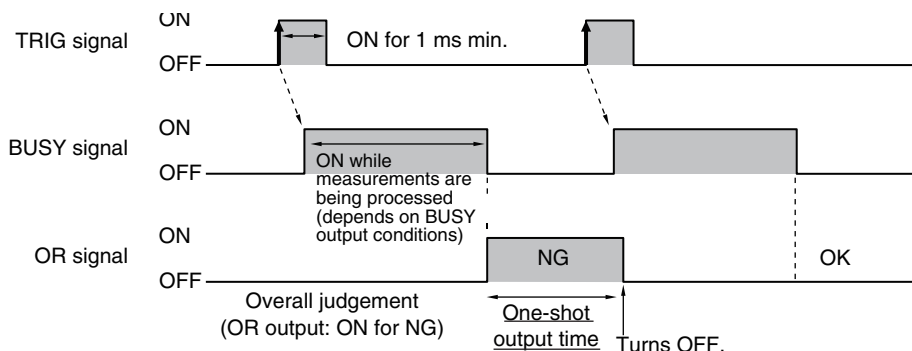

Delaying the Output Timing

When using one-shot output, the output timing of the OR signal can be delayed. (Setting range: 0 to 1,000 ms)

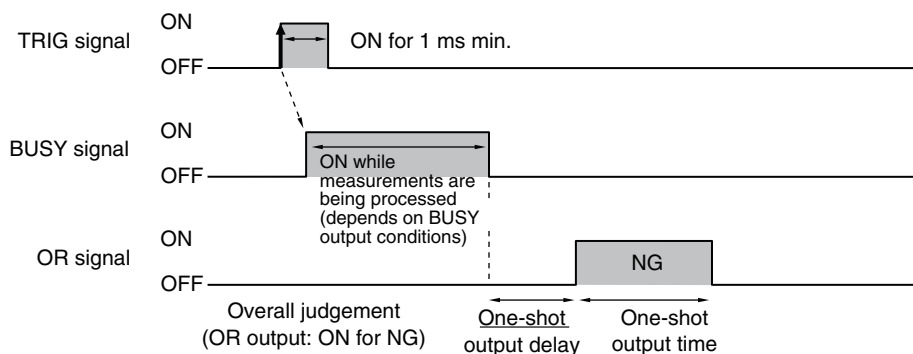

Settings

► [In/Out] – [I/O setting] – [I/O setting] – [Output]

- 1 Press [Output mode] and press [Level output] or [One-shot output].
- 2 Press [Output delay] and set the one-shot output delay.
- 3 Press [OK].

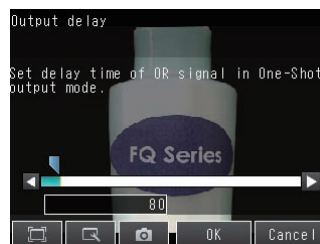

- 4 Press [Output time] and set the one-shot output time.
- 5 Press [OK].

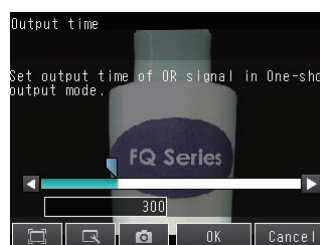

Item		Description
Output mode	One-shot output	After the measurement results are finalized, if the judgement output ON condition is met, the OR signal is turned ON for the one-shot output time. It is then turned OFF once the specified time has expired.
	Level output (default)	The judgement is output after measurement results are finalized and the ON/OFF status of the OR signal is held until it is changed for the next measurement result.
Output delay		When one-shot output mode is selected, this parameter sets the delay from when a measurement is completed until when the OR signal turns ON. (Setting range: 0 to 1,000 ms)
Output time		When one-shot output mode is selected, this parameter sets the time that the OR signal is ON. (Setting range: 1 to 1,000 ms)

Important

When one-shot output is selected as the output mode, make the following value smaller than the trigger input period.

- One-shot delay time + One-shot output time

Changing the Judgement Output ON Conditions

The ON condition for the OR signal or the OR0 to OR31 signals can be set to be output when the judgement results are OK or when they are NG. The default setting is when they are NG.

Settings

▶ [In/Out] – [I/O setting] – [I/O setting] – [Output] – [OR output]

Item		Description
OR output	OK: ON	The output is turned ON if the judgement is OK. For the overall judgement, the output is turned ON if all judgements are OK.
	NG: ON (default)	The output is turned ON if the judgement is NG. For the overall judgement, the output is turned ON if even one judgements is NG.

Changing the Polarity of the BUSY Output

The Sensor turns ON the BUSY output signal during measurements and other processing to indicate that a measurement trigger cannot be received. The polarity of the BUSY signal can be reversed so that it is ON only when a trigger signal can be received.

In the default settings, the BUSY signal is assigned to OUT1. If you change the assignment of the BUSY signal, change the polarity of the corresponding output.

Settings

▶ [In/Out] – [I/O setting] – [I/O setting] – [Output] – [OUT1 Polarity]

Item		Description
OUT1 Polarity	Positive (default)	The BUSY signal is ON while the Sensor is processing data.
	Negative	The BUSY signal is ON while the Sensor can receive a trigger signal.

Important

All timing charts in this manual show the operation of the BUSY signal with positive polarity (the default setting). If you change the polarity of the BUSY signal, take this into consideration when reading the timing charts.

Adjusting the End Timing of the BUSY Signal

The end timing of the BUSY signal can be changed.

► [In/Out] – [I/O setting] – [I/O setting] – [Output] Tab Page – [BUSY output]

Item		Description
BUSY output	Measurement (default)	The BUSY signal turns OFF when the measurement is completed.
	Data logging	The BUSY signal turns OFF when data logging is completed.
	Image logging	The BUSY signal turns OFF when image logging is completed.
	Result display	The BUSY signal turns OFF when the result display is completed.

Important

Do not disconnect the Ethernet cable between the Sensor and the Touch Finder if the Sensor and Touch Finder are connected through an Ethernet switch and the BUSY output condition is set to [Data logging], [Image logging], or [Result display].

The Sensor will wait for the Touch Finder to answer, and the results and measurement time will be affected.

To disconnect the Sensor and Touch Finder during measurements in the above situation, clear the selection of the Sensor from the list of Sensors on the Touch Finder before you disconnect the cable.

Changing the Polarity of the Output Signals

You can change the polarity of the output signals that are assigned to OUT0 to OUT3 (regardless of what signal is assigned to the output).

Settings

► [In/Out] – [I/O setting] – [I/O setting] – [Output] – [OUT0 Polarity], [OUT1 Polarity] or [OUT2 Polarity]

Item		Description
OUT0 Polarity, OUT1 Polarity, or OUT2 Polarity	Positive (default)	The output signal that is assigned to OUT0 to OUT3 is turned ON when the Sensor is executing a process.
	Negative	The output signal that is assigned to OUT0 to OUT3 is turned ON when the Sensor can receive the trigger.

Changing the Types of Commands That Can Be Used

You can select the types of commands used in IN0 to IN5.

Settings

► [In/Out] – [I/O setting] – [I/O setting] – [Input] – [Input mode]

Item		Description
Input mode	Standard mode (default)	IN0 to IN4 are only used for line process changes. A maximum of 32 scenes are selectable.
	Expanded mode	Enables use of IN0 to IN4 for commands other than line process changes. A maximum of 16 scenes are selectable.

Controlling the Sensor from an External Device

The following Sensor functions can be controlled with command inputs from an external device without connecting the Touch Finder.

Function	Description	Reference
Changing the Scene	This command changes the scene when the line process changes.	p. 46
Registering the Measurement Reference Again	This command re-registers the judgement references for measurement when levels are changed.	p. 49
Turning the ERROR Signal OFF	This command turns the ERROR signal OFF.	p. 51
Performing Continuous Measurements	This command continues measurement is performed while this command is input.	p. 37
Clearing Measurement Values	This command clears the measurement values.	p. 52
Saving Data in Sensor	This command saves the settings data to the Sensor.	p. 57
Retrying Inspection by External Signal (trigger retry)	This command continues inspection when the trigger signal is ON.	p. 52
Resetting the Sensor	This command resets the Sensor.	p. 55
Executing External Teaching	This command executes teaching for all target items.	p. 58

Important

Change to Expanded Mode before you input any command other than a command to change the scene. If you change to Expanded Mode, you can use any of the commands. However, in Expanded Mode, you can change to only 16 scenes with the parallel SCENE command instead of 32 scenes.

 Changing the Types of Commands That Can Be Used: p. 45

Changing the Scene

This section describes how to change to a specified scene number.

Wiring

Color	Signal	State		Description
		Input Mode		
		Standard Mode	Expanded Mode	
Gray	IN0	Scene number (0 to 31)	Scene number (0 to 15)	Specifies the scene number. IN0 to IN4 correspond to the binary bits of the scene number. Example: To change to scene 1 in Standard Mode, specify as follows: $\begin{array}{ccccc} 0 & 0 & 0 & 0 & 1 \\ \text{(IN4)} & \text{(IN3)} & \text{(IN2)} & \text{(IN1)} & \text{(IN0)} \end{array}$
Green	IN1			
Red	IN2			
White	IN3			
Purple	IN4		ON	
Yellow	IN5	ON		Trigger to change the scene
Orange	OUT1 (BUSY)	--		Processing in progress (default)

The signals shown at the left are used.

Refer to the following information for signal wiring.

 Section 2 Installation and Connections in Vision Sensor FQ2-S/CH Series User's Manual (Cat. No. Z337)

Timing Chart

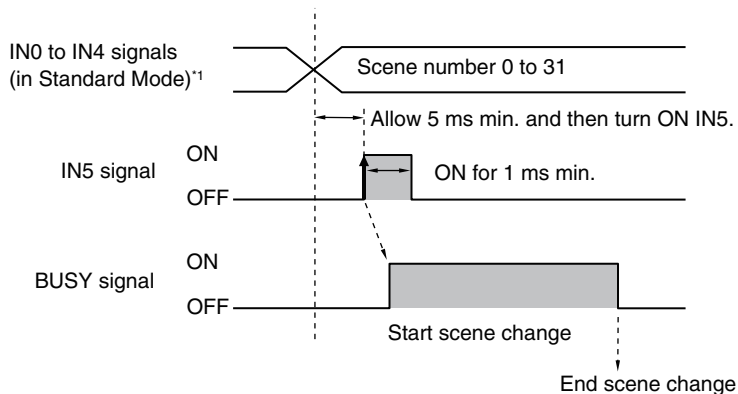

*1: In Expanded Mode, specify scene numbers 0 to 15 using the IN0 to IN3 signals.

- 1 Specify the scene number with the IN0 to IN4 signals. (Standard Mode)
- 2 Turn ON the IN5 signal while the BUSY signal is ON to change the scene to the specified scene.
- 3 The BUSY signal turns ON while the scene is being switched.

Important

The scene numbers that can be used depend on the input mode.

[Standard mode] (default): Scene 0 to 31

[Expanded mode]: Scene 0 to 15

 Changing the Types of Commands That Can Be Used: p. 45

Note

- Even in Expanded Mode, you can use menu commands or Ethernet no-protocol commands to change to scenes 0 to 31.
- The input mode can be set on both standard models and single-function models.

Sample Ladder Program

This sample program is used to change the scene when the input mode is set to Expanded Mode. The scene changes to scene 1 when W0.00 turns ON.

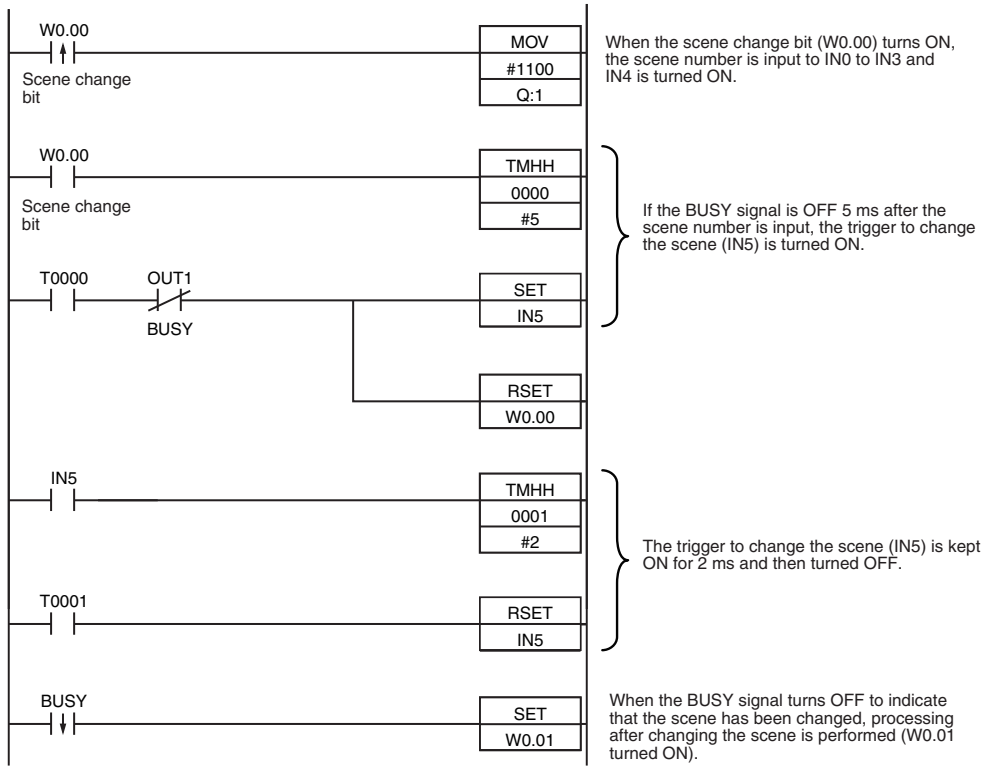

• I/O Signal Allocations

Signal		Address
Output signals	OUT1 (BUSY signal)	CIO 0.01
Input signals	IN0	CIO 1.08
	IN1	CIO 1.09
	IN2	CIO 1.10
	IN3	CIO 1.11
	IN4	CIO 1.12
	IN5	CIO 1.15

Note

The amount of time it takes for a scene to change depends on the scene settings. The BUSY signal turns ON while scene change is being executed, so the scene change execution time can be checked with the BUSY signal.

Important

If the cycle time is too long, the PLC may not be able to detect when the BUSY signal is ON. If necessary, turn OFF W0.00 after a suitable time elapses.

Registering the Measurement Reference Again

When the line process is changed or otherwise, the model and reference color can be reregistered based on the previously loaded image. Data that can be re-registered with the reregistration command are shown below.

Inspection item	Re-registered data
Search, Shape Search II	Model data
Color Data	Reference color (hue, saturation, and brightness)
Edge Position, Edge Width, Area	None

Note

- This command is only valid in Expanded Mode.
- Application is possibly only from the Run Mode
- If the parameter is applicable to more than one inspection item, it will be re-registered for all inspection items.

Settings

► **[In/Out] – [I/O setting] – [I/O setting] – [Input] – [Input mode]**

Press [Expand mode].

Wiring

Color	Signal	State	Description
Gray	IN0	OFF	Command parameter for registering the measurement reference again
Green	IN1	OFF	
Red	IN2	OFF	
White	IN3	ON	
Purple	IN4	OFF	Command input for registering the measurement reference again
Yellow	IN5	ON	
Orange	OUT1 (BUSY)	--	Processing in progress (default)

The signals shown at the left are used.

Refer to the following information for signal wiring.

 Section 2 Installation and Connections in Vision Sensor FQ2-S/CH Series User's Manual (Cat. No. Z337)

Timing Chart

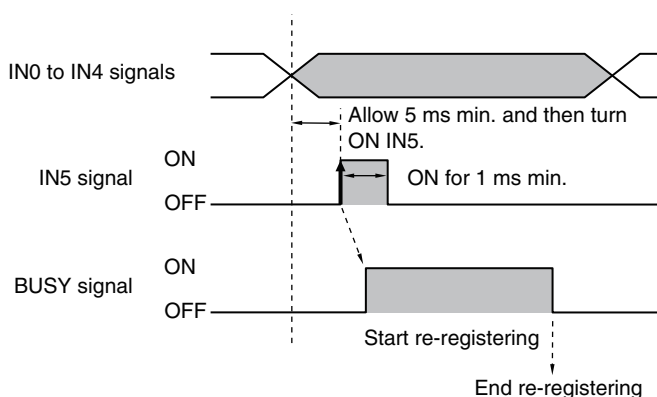

- 1 Turn OFF IN0 to IN4 and turn ON IN3.
- 2 Turn ON the IN5 signal while the BUSY signal is OFF to register the model data and reference color again from the image that was just input.
- 3 The BUSY signal turns ON while the parameters are being re-registered.

Sample Ladder Program

This sample program is used to input IN5 to re-register a model.

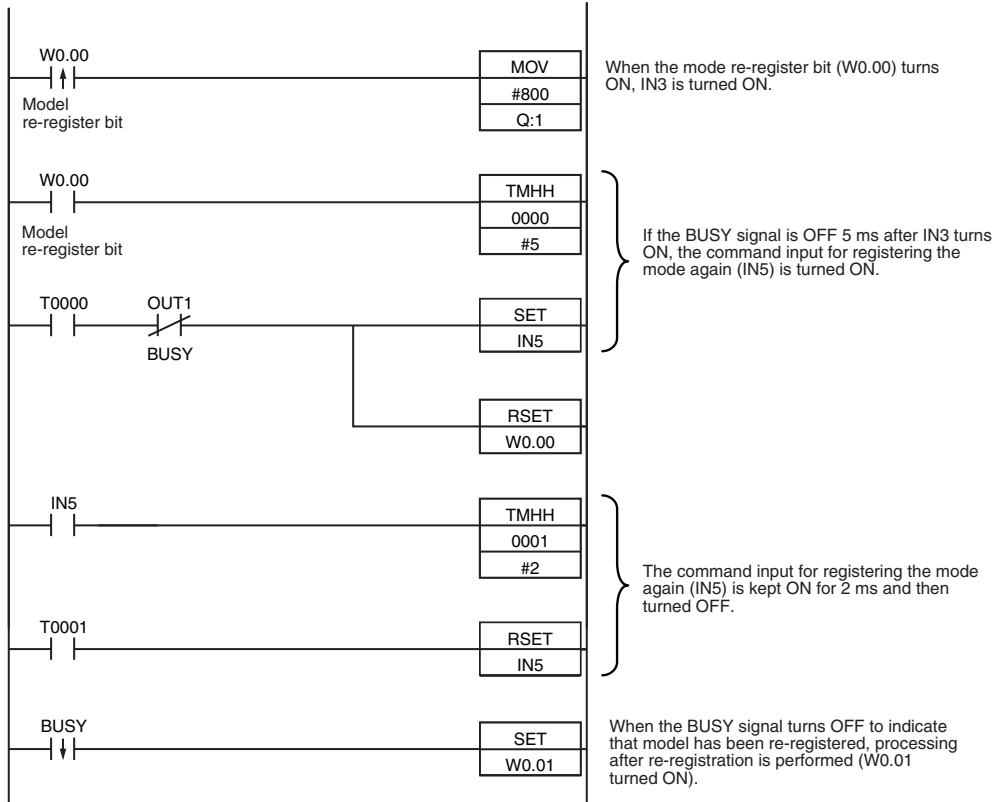

• I/O Signal Allocations

Signal		Address
Output signals	OUT1 (BUSY signal)	CIO 0.01
Input signals	IN0	CIO 1.08
	IN1	CIO 1.09
	IN2	CIO 1.10
	IN3	CIO 1.11
	IN4	CIO 1.12
	IN5	CIO 1.15

Note

The BUSY signal will be ON while the model is being re-registered.

Important

If the cycle time is too long, the PLC may not be able to detect when the BUSY signal is ON. If necessary, turn OFF W0.00 after a suitable time elapses.

Turning the ERROR Signal OFF

The ERROR signal turns ON when an error occurs.

After removing the cause of the error, turn the ERROR signal OFF using one of the following methods.

Method 1: Input an error clear command from an external device such as a PLC.

Method 2: Input a measurement trigger again.

(For example, turn the TRIG signal ON during a one-shot measurement.)

The ERROR signal will turn OFF when measurement is executed correctly.

Note

- This command is only valid in Expanded Mode.
- This function can be used in Run Mode only.

Wiring

Color	Signal	State	Description
Gray	IN0	OFF	Command parameter for clearing errors
Green	IN1	OFF	
Red	IN2	ON	
White	IN3	OFF	
Purple	IN4	OFF	
Yellow	IN5	ON	Command input for clearing errors
Orange	OUT1 (BUSY)	--	Processing in progress (default)
Light blue	OUT2 (ERROR)	--	ERROR signal (default)

The signals shown at the left are used.

Refer to the following information for signal wiring.



Section 2 Installation and Connections in Vision Sensor FQ2-S/CH Series User's Manual (Cat. No. Z337)

Timing Chart

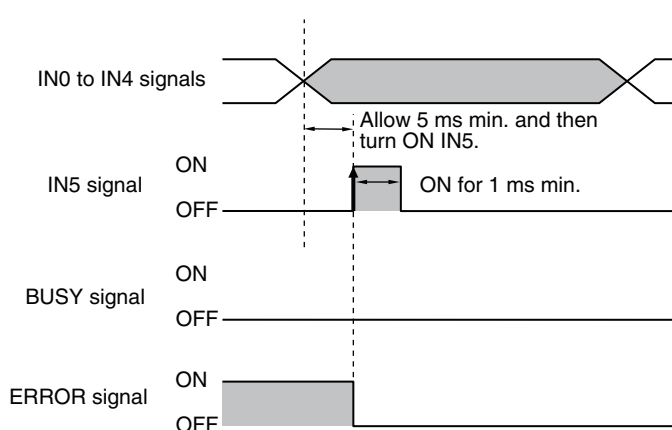

- 1 Turn OFF IN0 to IN1 and IN3 to IN4 and turn ON IN2.
- 2 Turn ON the IN5 signal while the BUSY signal is OFF to clear the error.

Clearing Measurement Values

This command clears the measurement values that are stored in the Sensor. However, the OR signal and the output signals that are assigned to OUT0 to OUT2 are not cleared.

Note

- This command is only valid in Expanded Mode.
- This function can be used in Run Mode only.

Wiring

Color	Signal	State	Description
Gray	IN0	ON	Command parameter for clearing measurement values
Green	IN1	OFF	
Red	IN2	ON	
White	IN3	OFF	
Purple	IN4	OFF	
Yellow	IN5	ON	Command input for clearing measurement values
Orange	OUT1 (BUSY)	--	Processing in progress (default)

The signals shown at the left are used. Refer to the following information for signal wiring.



Section 2 Installation and Connections in Vision Sensor FQ2-S/CH Series User's Manual (Cat. No. Z337)

Timing Chart

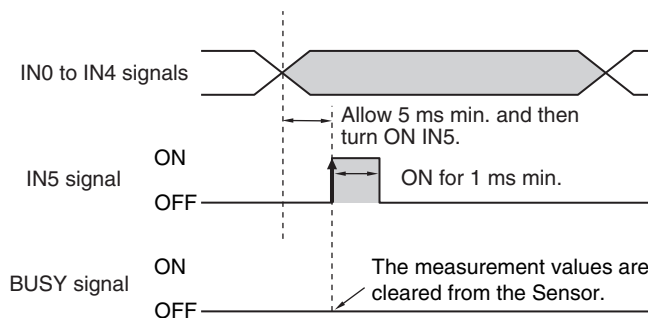

- 1 Turn ON IN0 and IN2 and turn OFF IN1, IN3 and IN4.
- 2 Turn ON the IN5 signal while the BUSY signal is OFF to clear the measurement values.

Retrying Inspection by External Signal (Trigger Retry)

Measurement is repeated until all inspection items have been successfully scanned.

Retry inspection ends when any one of the following conditions is satisfied:

- (1) The scanning result of all inspection items is OK.
- (2) Trigger retry (this command) turns OFF.
- (3) The timeout time is exceeded.

Note

- This command is only valid in Expanded Mode.
- This function can be used in Run Mode only.

Wiring

Color	Signal	State	Description
Gray	IN0	OFF	Command parameters for trigger retry (this command)
Green	IN1	OFF	
Red	IN2	ON	
White	IN3	ON	
Purple	IN4	OFF	Command input for trigger retry (this command)
Yellow	IN5	ON	
Orange	OUT1 (BUSY)	--	Busy
Black	OUT0 (OR)	--	Overall judgment (default)

The signals shown at the left are used.

Refer to the following information for signal wiring.



Section 2 Installation and Connections in Vision Sensor FQ2-S/CH Series User's Manual (Cat. No. Z337)

Timing Chart

- When inspection is OK

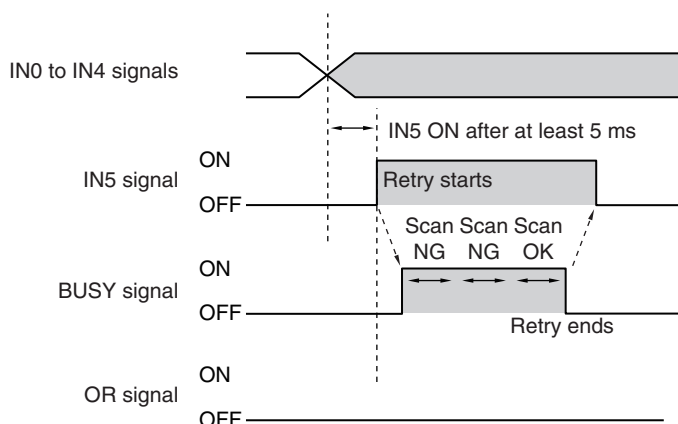

- 1 IN0, IN1 and IN4 are turned OFF, IN2 and IN3 are turned ON.
- 2 When IN5 is turned OFF > ON with the BUSY signal OFF, trigger retry inspection starts.
- 3 When retry inspection starts, the BUSY signal turns ON.
- 4 When the overall judgment turns ON, retry inspection ends and the BUSY signal turns OFF.
- 5 After verifying that the BUSY signal has turned ON > OFF, IN5 is turned ON > OFF.

- When inspection is NG

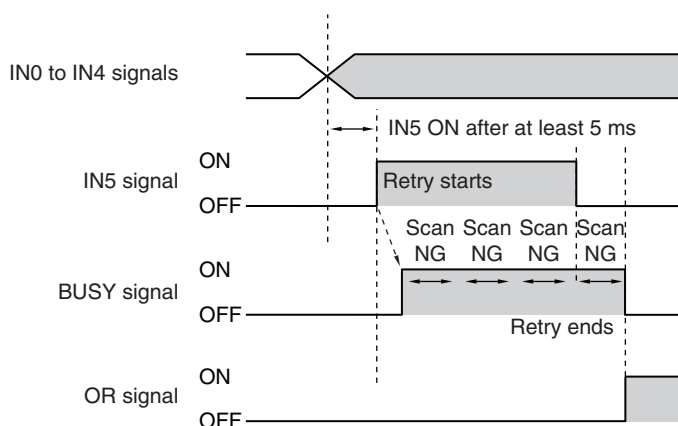

- 1 IN0, IN1 and IN4 are turned OFF, IN2 and IN3 are turned ON.
- 2 When IN5 is turned OFF > ON with the BUSY signal OFF, trigger retry inspection starts.
- 3 When retry inspection starts, the BUSY signal turns ON.
- 4 IN5 is turned OFF and retry inspection ends. If retry inspection ends but the overall judgment is NG, the OR signal turns ON. (Output polarity: When ON at NG)

Sample Ladder Program

This sample ladder program executes trigger retry when the I/O input mode is Expanded Mode. Trigger retry is executed at W0.00 ON.

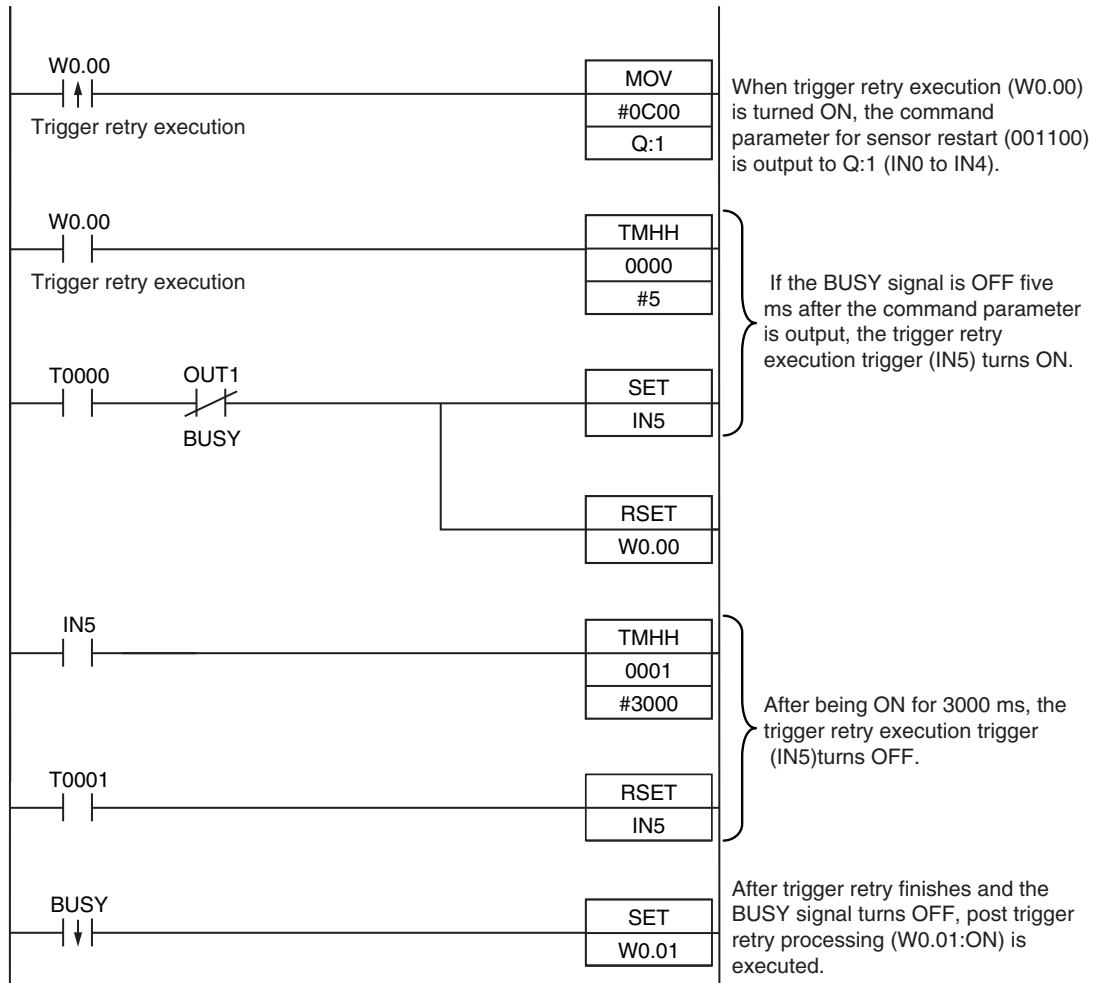

• I/O Signal Allocations

Signal type	Address	
Output signal	OUT1 (BUSY signal)	CIO 0.01
Input signals	IN0	CIO 1.08
	IN1	CIO 1.09
	IN2	CIO 1.10
	IN3	CIO 1.11
	IN4	CIO 1.12
	IN5	CIO 1.15

Note

The time the BUSY signal is ON is the trigger retry execution time.

Important

It may happen that the PLC is unable to recognize BUSY signal ON because the sample time is slow or otherwise. In this event, have W0.00 turn OFF at a suitable time.

Resetting the Sensor

Sensor reset is explained below.

Note

- This command is only valid in Expanded Mode.
- This function can only be used in Run mode.

Wiring

Color	Signal	State	Description
Gray	IN0	OFF	Command parameters for Sensor reset
Green	IN1	ON	
Red	IN2	OFF	
White	IN3	ON	
Purple	IN4	OFF	
Yellow	IN5	ON	Command input for Sensor reset
Orange	OUT1 (BUSY)	--	Busy (default)

The signals shown at the left are used.

Refer to the following information for signal wiring.

 Section 2 Installation and Connections in Vision Sensor FQ2-S/CH Series User's Manual (Cat. No. Z337)

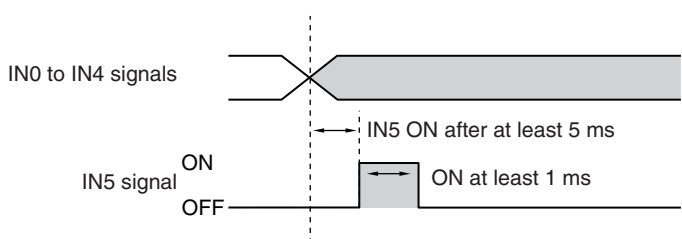

- 1 IN0, IN2 and IN4 are turned OFF, IN1 and IN3 are turned ON.
- 2 IN5 is turned OFF > ON with the BUSY signal OFF. The BUSY signal does not turn ON while the restart command is being received.
- 3 When the initialization process starts, the BUSY signal turns ON. For the initialization process, refer to the following:

 Operation with Default Configuration: p.34

Sample Ladder Program

This sample program inputs IN5 to restart the Sensor.
Trigger retry is executed at W0.00 ON.

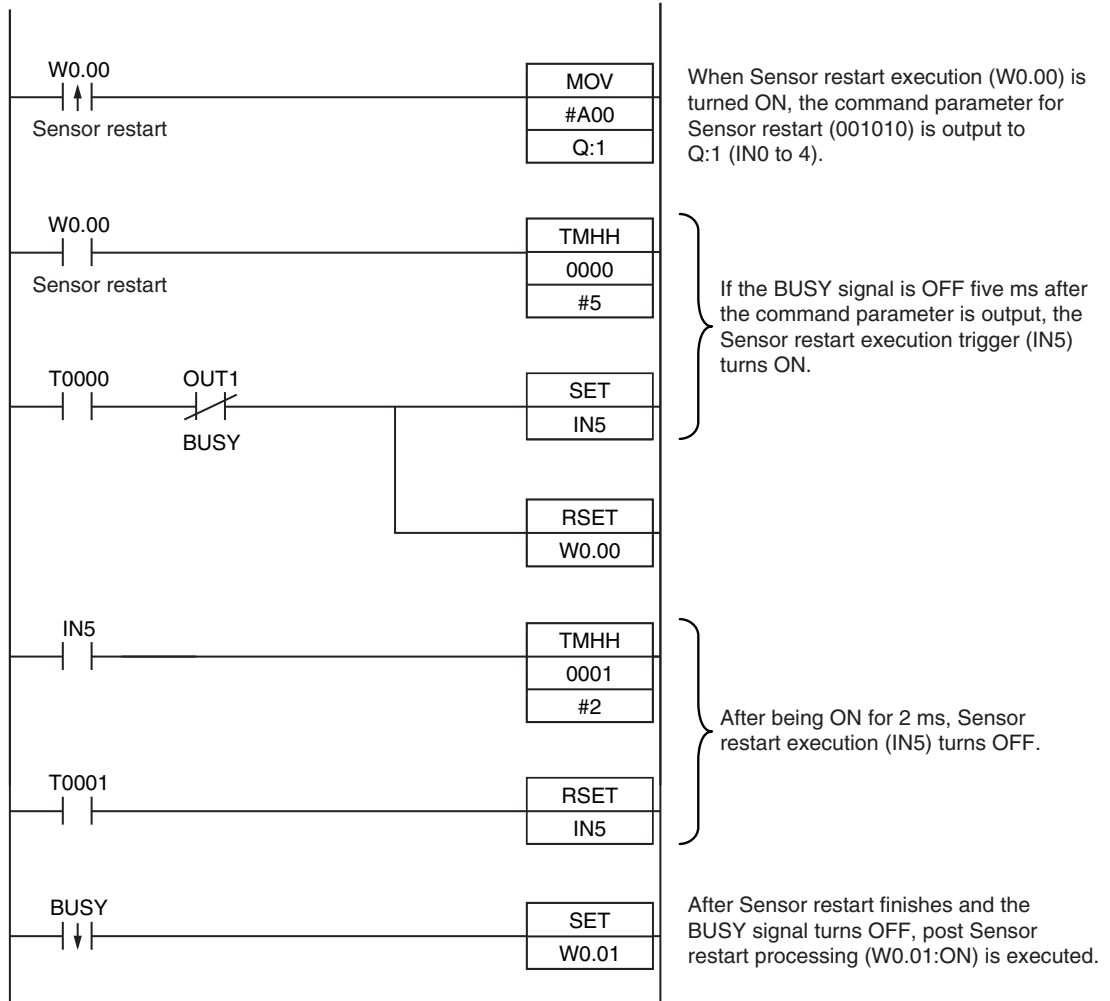

• I/O Signal Allocations

Signal type		Address
Output signal	OUT1 (BUSY signal)	CIO 0.01
Input signals	IN0	CIO 1.08
	IN1	CIO 1.09
	IN2	CIO 1.10
	IN3	CIO 1.11
	IN4	CIO 1.12
	IN5	CIO 1.15

Note

The time the BUSY signal is ON is the Sensor initialization process execution time.

Important

It may happen that the PLC is unable to recognize BUSY signal ON because the cycle time is slow or otherwise. In this event, have W0.00 turn OFF at a suitable time.

Saving Data in Sensor

You can save the current settings (scene data and system data) in the Sensor.

Note

- This command is only valid in Expanded Mode.
- This function can be used in Run Mode only.

Wiring

Color	Signal	State	Description
Gray	IN0	ON	Command parameters for saving data to the Sensor
Green	IN1	OFF	
Red	IN2	OFF	
White	IN3	OFF	
Purple	IN4	OFF	
Yellow	IN5	ON	Command input for saving data to the Sensor
Orange	OUT1 (BUSY)	--	Processing in progress (default)

The signals shown at the left are used.

Refer to the following information for signal wiring.



Section 2 Installation and Connections in Vision Sensor FQ2-S/CH Series User's Manual (Cat. No. Z337)

Timing Chart

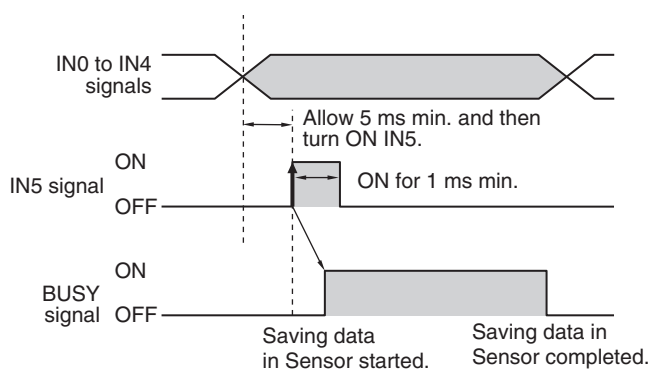

- 1 Turn ON IN0 and turn OFF IN1 to IN4.
- 2 Turn ON the IN5 signal while the BUSY signal is OFF to save the data in the Sensor.

Executing External Teaching

Teaching for all registered items can be executed using the current input image.

Note

- This command is only valid in Expanded Mode.
- Application is possibly only from the Run Mode
- If the parameter is applicable to more than one inspection item, it will be external teaching for all inspection items.

Wiring

Color	Signal	State	Description
Gray	IN0	ON	Command parameter for external teaching
Green	IN1	OFF	
Red	IN2	OFF	
White	IN3	ON	
Purple	IN4	OFF	Command input for external teaching
Yellow	IN5	ON	
Orange	OUT1 (BUSY)	--	

The signals shown at the left are used.

Refer to the following information for signal wiring.



Section 2 Installation and Connections
in Vision Sensor FQ2-S/CH
Series User's Manual
(Cat. No. Z337)

Timing Chart

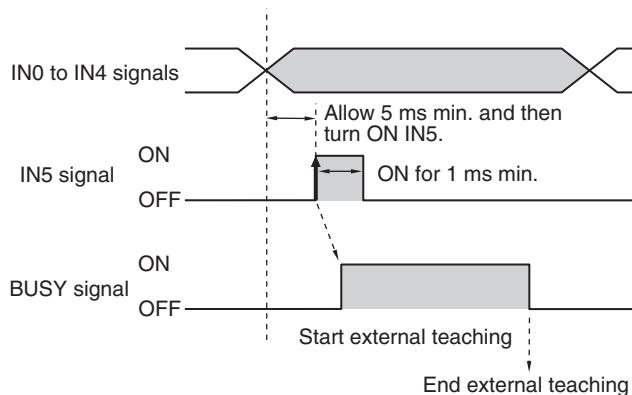

- 1 Turn ON IN0 and IN3 and turn OFF IN1, IN2, and IN4.
- 2 Turn ON the IN5 signal while the BUSY signal is OFF to execute external teaching.
- 3 The BUSY signal turns ON while external teaching is being executed.

Sample Ladder Program

This sample program is used to input IN5 to external teaching.

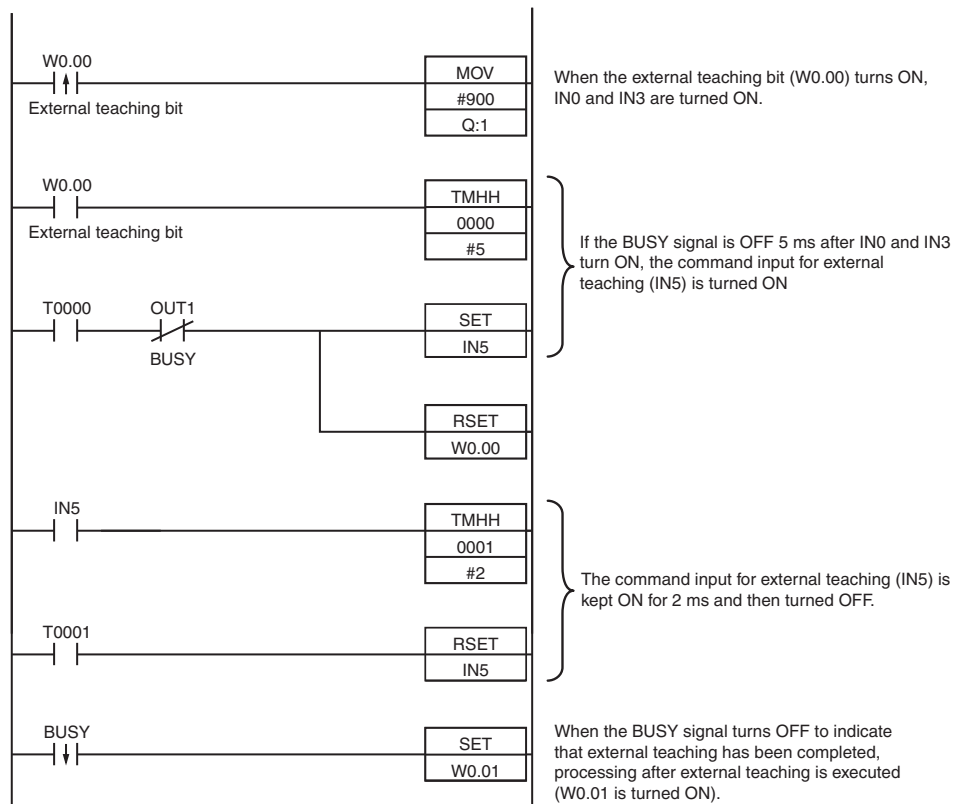

• I/O Signal Allocations

Signal		Address
Output signals	OUT1 (BUSY signal)	CIO 0.01
Input signals	IN0	CIO 1.08
	IN1	CIO 1.09
	IN2	CIO 1.10
	IN3	CIO 1.11
	IN4	CIO 1.12
	IN5	CIO 1.15

Note

The BUSY signal will remain ON while external teaching is being executed.

Important

If the cycle time is too long, the PLC may not be able to detect when the BUSY signal is ON. If necessary, turn OFF W0.00 after a suitable time elapses.

2-2 Controlling Operation and Outputting Data with a Parallel Interface Sensor Data Unit

Overview

If you mount a Parallel Interface Sensor Data Unit, in addition to outputting OR judgement results, you can also use the Parallel Interface Sensor Data Unit to output the judgement results of judgement conditions that you set for parallel output (called parallel judgement output) and the results of measurement values and expressions for inspection items (called parallel data output).

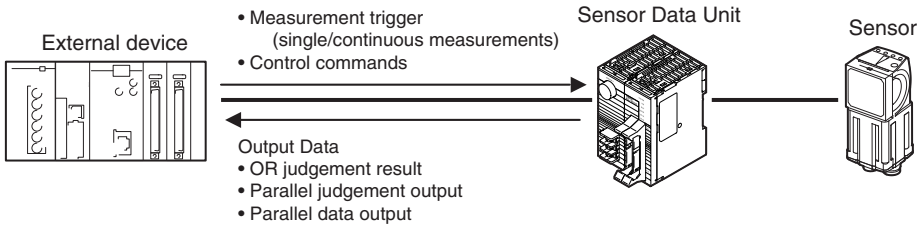

Setting the Measurement Trigger

The measurement trigger can be chosen from the following two types:

- Single measurement: One measurement is performed for each external trigger.
- Continuous measurement: Measurements are performed continuously.

Refer to the following page for data output timing and signal status after measurement trigger execution.

 Aligning the Data Output Timing with the External Device: p. 66

Performing One Measurement for Each External Trigger

A measurement trigger is input as the TRIG signal from a proximity sensor, PLC, or other external device. One measurement is performed when the TRIG signal turns ON.

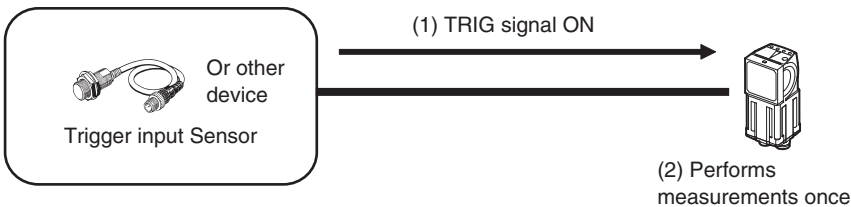

Performing Continuous Measurements

Continuous measurements are performed while the continuous measurement command is input from an external device.

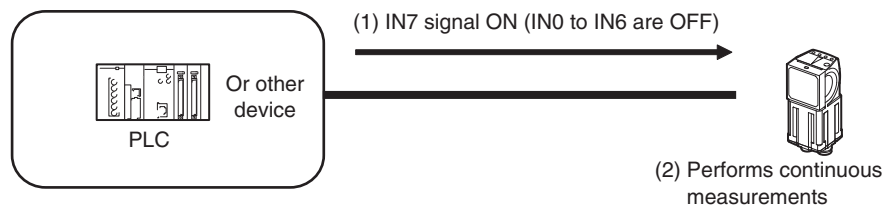

Setting Output Data

You can set the data to output after measurements.

Output Data

You can output any of the following data through the Parallel Interface Sensor Data Unit.

Data	Output contents	Signal used to output the data
Overall judgement result	Judgement result of multiple inspection items (ON if even one judgement result is NG)	The results is output with the OR signal.
Parallel judgement output	Judgement results of the judgement conditions that are set for parallel output	The results are assigned to and output with D0 to D15.
Parallel data output	Measurement values for inspection items and results from expressions	The data is output as 16-bit data on D0 to D15.

Outputting the Overall Judgement Result (OR Signal)

When the results of the inspection items are judged, if even one individual judgement result is NG, the OR output signal is turned ON.

Note

- You can also turn ON the overall judgement result output signal when all individual judgement results are OK.
 - Changing the Judgement Output ON Conditions: p. 44
- You can select whether to use the judgement result of one of the calculations (0 through 31) as the overall judgement.
 - Section 4 Setting Up Inspections in Vision Sensor FQ2-S/CH Series User's Manual (Cat. No. Z337)
- You can adjust the timing for outputting the OR signal and the ON time after judgement processing.
 - Adjusting the Judgement Output Timing: p. 42

Parallel Judgement Outputs

You can set judgement conditions for parallel output and then output the judgement results for those conditions.

● Setting the Items to Judge and the Judgement Conditions

You can assign up to 16 judgement results to and output them from the D0 to D15 signals.

As the items to judge, you can specify the measurement data from inspection items that can be output and the calculation results from the expression settings.

Use the following procedure to set the items to judge and the judgment conditions.

(1) Setting the Items to Judge

You can assign the parameters from the inspection items to the data output signals (D0 to D15).

The following procedure shows how to assign the measured position X of [0. Search] to D0.

▶ [In/Out] – [I/O setting] – [Output data set] – [Par. Jdg Output] – [Basic] Tab Page

- 1 Press [Settings].
- 2 Press [0.D0].
- 3 Press [IO. Search].
- 4 Press [Position X X].

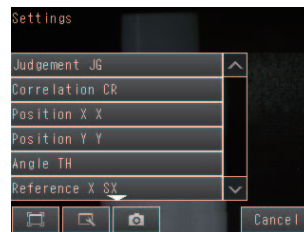

- 5 If the inspection item allows multi-point output, press the number ([0] to [31]) of the inspection result for which to output the data from the list of inspection results.

To register something to D1 or higher, repeat this process.

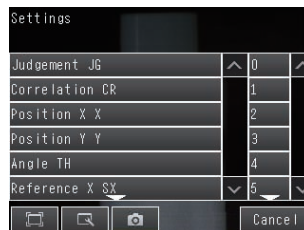

(2) Setting the Judgement Conditions

▶ [In/Out] – [I/O setting] – [Output data set] – [Par. Jdg Output] – [Basic] Tab Page

- 1 Press [Judgement condition].
- 2 Set the correlation range that is to be judged as OK.

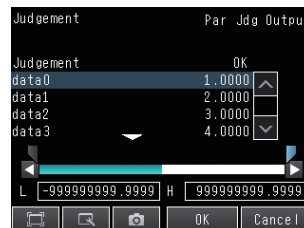

● Reflecting Judgement Results to the Overall Judgement

You can specify whether to reflect the judgement result of a parallel judgement output in the overall judgement. (The default is to reflect them.)

▶ [In/Out] – [I/O setting] – [Output data set] – [Par. Jdg Output] – [Details] Tab Page – [Output parameter] – [Reflect]

● Stopping Data Output

You can also prevent the judgement results that are set from actually being output. (The default setting is [Yes].)

▶ [In/Out] – [I/O setting] – [Output data set] – [Par. Jdg Output] – [Details] Tab Page – [Output parameter] – [Data output]

Parallel Data Output

You can output the following data as 16-bit data by setting them as the output data (data 0 to data 31): measurement data from inspection items that can be output and the calculation results from the expression settings.

● Setting the Data to Output

You can individually assign the parameters of the inspection items to output data (data 0 to data 31).

The following procedure shows how to assign the measured position X of [0. Search] to data 0 for a parallel output.

▶ [In/Out] – [I/O setting] – [Output data set] – [Par. Jdg Output] – [Basic] Tab Page

- 1 Press [Data settings].
- 2 Press [Data 0].
- 3 Press [I0. Search].
- 4 Press [Position X X].

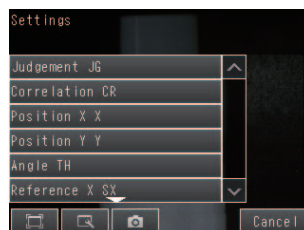

- 5 If the inspection item allows multi-point output, press the number ([0] to [31]) of the inspection result for which to output the data from the list of inspection results.

To register something to data 1 or higher, repeat this process.

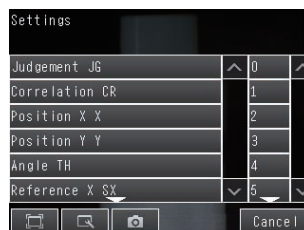

● Setting the Output Form

▶ [In/Out] – [I/O setting] – [Output data set] – [Par. Jdg Output] – [Basic] Tab Page

- 1 Press [Output format].
- 2 Press [Output form].
- 3 Set [Data form] to [Binary] or [BCD].

● Stopping Data Output

You can also prevent the output data that is set from actually being output. (The default setting is [Yes].)

▶ [In/Out] – [I/O setting] – [Output data set] – [Parallel Data Output Setting] – [Details] Tab Page – [Output parameter] – [Data output]

● Output Specifications

- Only the integer portions of numbers are output. All digits before the decimal point are rounded off.
- The following range of values can be output.

Binary data: -32768 to +32767

BCD data: -999 to +999

If the measurement value is out of range, the actual measurement value is not output and the minimum or maximum value of the range is output instead.

Data format	Measurement value that is below the possible output range	Measurement value that is above the possible output range
Binary data	A value of -32768 is output.	A value of +32767 is output.
BCD	A value of -999 is output.	A value of 999 is output.

Note

The data that is output to the OR and D signals after a measurement is held until the next measurement is performed. The values will continue to be output even after all measurements have been completed.

However, if you set the output timing of the OR signal to [One-shot output] in the [Output mode] parameter, the OR signal will turn OFF after the specified output time has elapsed.

Data Output Timing

● Output Sequence

If both parallel judgement output and parallel data output are performed at the same time, parallel judgement output will be performed first followed by parallel data output.

Example: Parallel Judgement Output of D0 to D15 and Parallel Data Output of Data 0

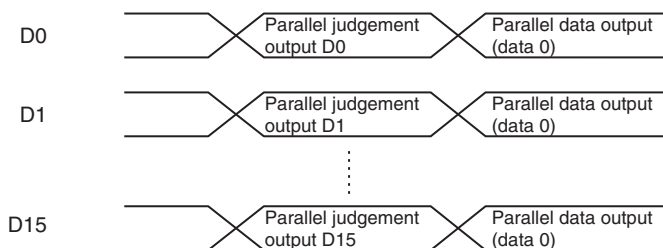

● Timing Chart

The following timing chart shows the data output timing for parallel judgement outputs.

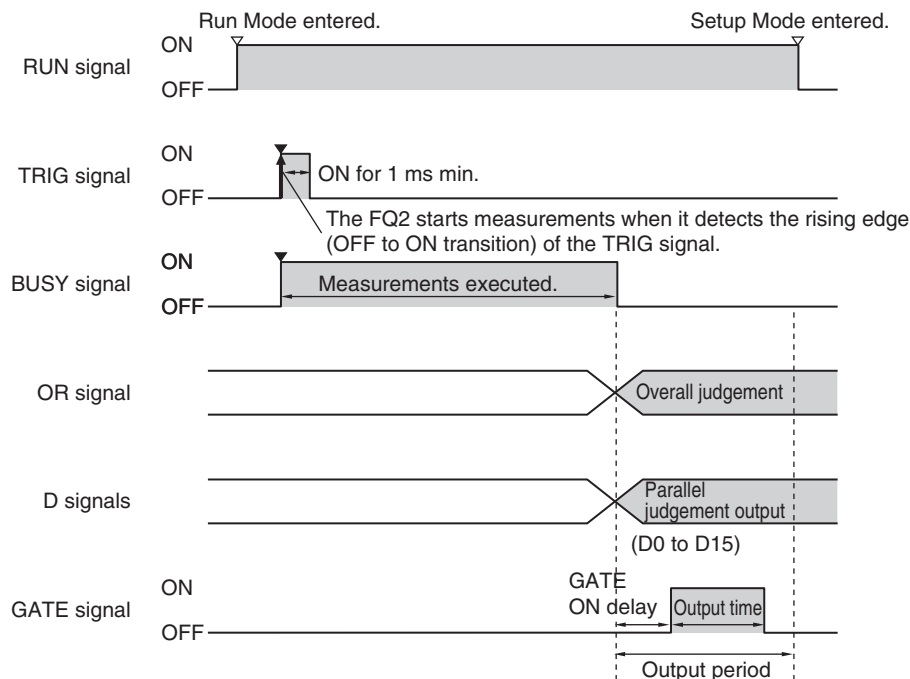

Output Signals



Signal	Function
RUN	This signal is ON while the Sensor is ready to take measurement and it is in Run Mode. The RUN signal is OFF in Setup Mode. Change to Run Mode for operation.
BUSY	This signal is ON when the Sensor is performing measurements, changing scenes, or performing other tasks. Do not input the next command while the BUSY signal is ON. The process that is currently being executed and the command that is input will not be executed correctly.
OR	This signal outputs the overall judgement. The signal is valid when the measurements are completed (i.e., when the BUSY signal changes from ON to OFF).
D	These signals output the parallel judgement output data and the calculation results of the expressions that are set for parallel data output. You can set whether the signal turns ON for an OK or for an NG judgement in the [Judgment output condition] output setting.  Changing the Settings of the Output Signals: p.74
GATE	This signal is used to control the timing of reading the D signals at an external device. It is turned ON for the period of time that is required to reliably read the D signals at the external device. Set the output period so that the total output time is shorter than the measurement interval (i.e., the TRIG signal input interval). The GATE signal is output only if parallel judgement output and parallel data output are set. The OR signal will be ON while the TRIG signal can be input.

Input Signals

Signal	Function
TRIG	This signal is used to input a measurement trigger from an external device, such as a photoelectric switch. One measurement is performed on the rising edge (OFF to ON transition) of the TRIG signal. Keep the TRIG signal ON for at least 1 ms.

Aligning the Data Output Timing with the External Device



You can use one of the following data output methods to align the timing of data output with an external device.

- Aligning with the GATE Signal Status (No Handshaking):  p. 66
- Outputting Measurement Results for Data Send Requests from the External Device (Handshaking):  p. 70
- Offsetting the Timing of Outputting Measurement Results:  p. 72

Setting Data Communications Specifications

▶ [In/Out] – [I/O setting] – [I/O setting] – [Output]

1 Press [Output control] and select the output control method.

- None:  p. 66
- Handshaking  p. 70
- Synchronized Output:  p. 72

2 Set the communications specifications for data output.

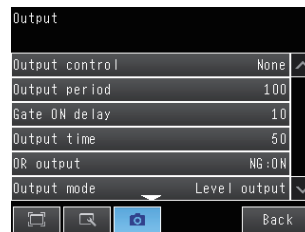

Item	Parameter	Description
Output control	None (default), Handshaking, or Sync. Output	None: Measurement results are output without synchronizing with the external device. Handshaking: Measurement results are output while synchronizing with the PLC. Sync. output: Measurement results are output without synchronizing with the external device.
Output period	2.0 to 5,000.0 ms 10.0 ms (default)	This setting is enabled only when the [Output control] or [Sync. Output] parameter is set to [None]. Set the period for outputting measurement results. Set a value that is longer than the GATE ON delay plus the output time and shorter than the measurement interval. If you set a value that is longer than the measurement interval, the output timing will become delayed as measurements are repeated.
GATE ON delay	1.0 to 1,000.0 ms 1.0 ms (default)	Set the time from when the result is output to the parallel interface until the GATE signal turns ON. This is the time to wait until the data output stabilizes. Set a value that is longer than the delay time of the external device.
Output time	1.0 to 1,000.0 ms 5.0 ms (default)	This setting is enabled only when the [Output control] parameter is set to [None] or [Sync. output]. Set the time to turn ON the GATE signal. Set the time that is required for the external device to read the measurement results.
Timeout	0.5 to 120.0 s 10.0 s (default)	This setting is enabled only when the [Output control] parameter is set to [Handshaking]. A timeout error will occur at the following times if there is no response from the external device within the time that is set. When the DSA signal turns ON after measurements are completed When the DSA signal turns OFF after the GATE signal turns ON When the DSA signal turns ON after the GATE signal turns OFF
Number of delay	1 to 15 1 (default)	This setting is enabled only when the [Output control] parameter is set to [Sync. output]. Set the number of times to ignore the TRIG signal turning ON between when the TRIG signal turns ON and the measurement results are output.

Reading Data When the GATE Signal Is Output (No Handshaking)

The Sensor will output the measurement results without synchronizing with the external device, but the GATE signal is also output.

The GATE signal is used to control the timing of when the external device reads the measurement data.

Adjust the external device so that it reads the measurement results when the GATE signal is output.

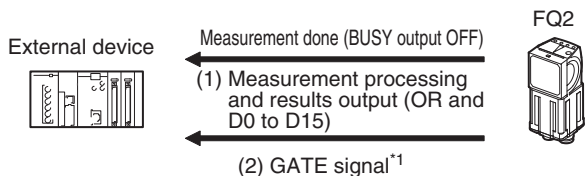

*1: You can change the settings of when the GATE signal is turned ON after the measurement data is output and the length of time that the GATE signal will remain ON.
 Setting the Output Timing for the GATE Signal: p. 66

Note

The GATE signal will not be output if there is no data set for parallel judgement output and parallel data output. If only the OR signal is output, read the OR signal when the BUSY signal turns OFF.

● Single Measurement

Example: Three Data Items Set for Parallel Data Output
Timing Chart

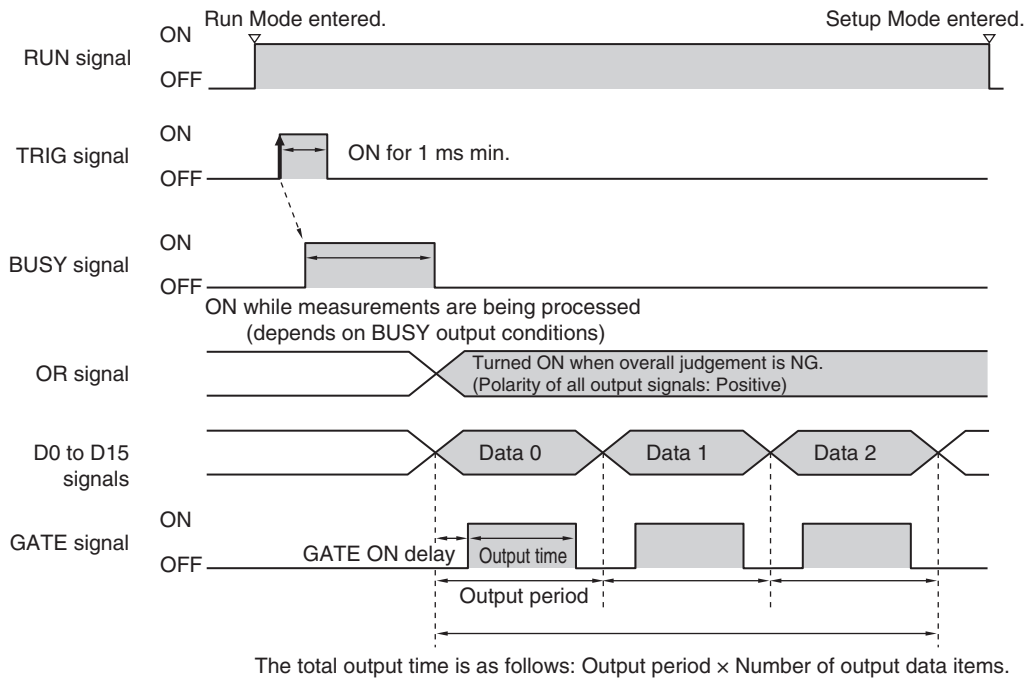

- 1** The RUN signal turns ON when measurements are enabled and the Sensor is in Run Mode.
- 2** Turn ON the TRIG signal while the BUSY signal is OFF.
- 3** Measurement begins and the BUSY signal is turned ON during the measurement process.
- 4** When the measurement has been finished, the measurement results are output using an OR signal and the D0 to D15 signals, and the BUSY signal is turned OFF.^{*1}

*1 You can also set the [BUSY output] parameter so that the BUSY signal is turned OFF after the completion of data logging, image logging, or displaying results.

- 5** After the BUSY signal turns OFF, the GATE signal is turned ON when the time that is set in the [GATE ON delay] parameter in the communications settings has elapsed.^{*2}
- 6** The GATE signal is turned ON, and then the GATE signal is turned OFF when the time that is set in the [Output time] parameter in the communications settings has elapsed.^{*2}

*2 Set the GATE ON delay and output time for the GATE signal so that the total time does not exceed the output period.

Important

Data Output Time and TRIG Signal Input Interval

Set the input interval for the TRIG signal so that it is equal to or greater than the total output time. If the input interval for the TRIG signal is shorter than the total output time, the output data buffer will eventually overflow and output data will be discarded.

● Continuous Measurements

Example: Only Data 0 Set for Parallel Data Output
Timing Chart

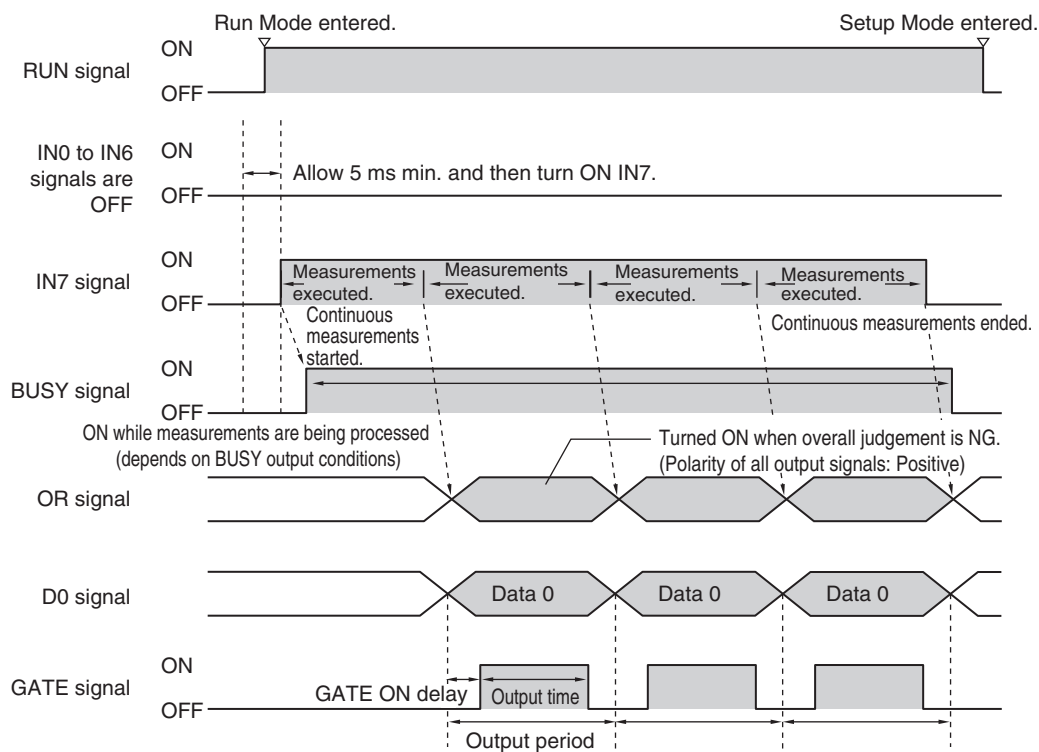

- 1** The RUN signal turns ON when measurements are enabled and the Sensor is in Run Mode.
 - 2** Turn ON IN7 while IN0 to IN6 are OFF. If this status is held while the BUSY signal is OFF, continuous measurements will begin and the BUSY signal will remain ON while continuous measurements are being performed.
 - 3** When measurement results are output, the GATE signal is turned ON when the time that is set in the [GATE ON delay] parameter in the communications settings has elapsed.*1
 - 4** The GATE signal is turned ON, and then the GATE signal is turned OFF when the time that is set in the [Output time] parameter in the communications settings has elapsed.*1
- 5** Continuous measurements end when the IN7 signal is turned OFF.

*1 Set the GATE ON delay and output time for the GATE signal so that the total time does not exceed the output period.

Note

The ERROR signal will turn ON if the input command is not executed normally.
Set at least one data output for parallel judgement output and then read the OR signal when the GATE signal turns ON.

Outputting Measurement Results for Data Send Requests from the External Device (Handshaking)

With handshaking, measurement results are output after there is a data send request (DSA signal) from the external device.

Handshaking is effective for sequentially outputting many measurement results and it is a reliable way to transfer data.

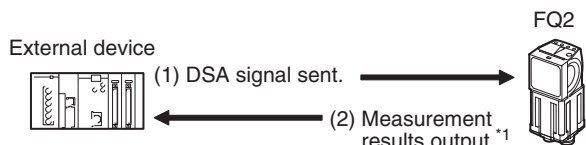

*1 The overall judgement (OR) is output even if the DSA signal is not output by the external device.

● DSA Signal

The DSA signal is used by the external device to request the next data transmission. The Sensor will not output data until the DSA signal is turned ON. When the external device is ready for reception, turn ON the DSA signal.

● Timing Chart

Example: Three Data Items Set for Parallel Data Output

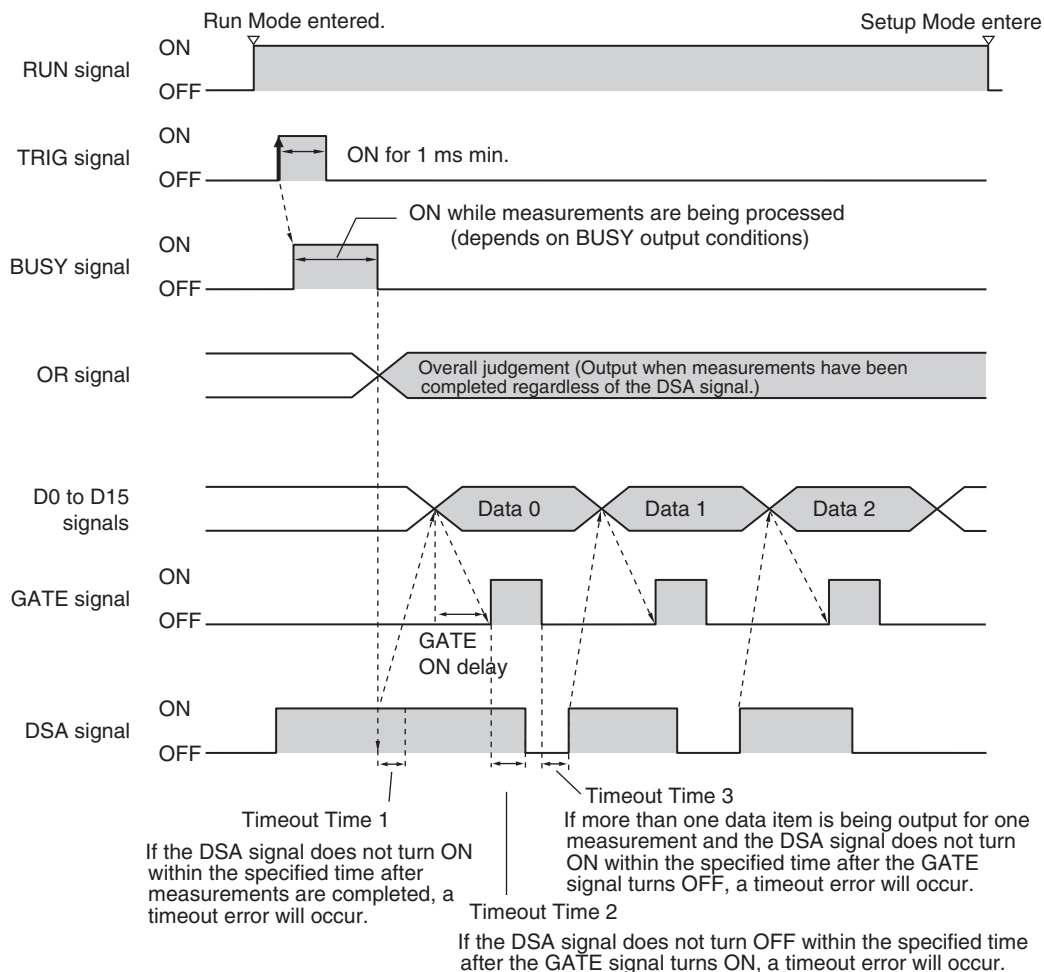

- 1 Turn ON the TRIG signal while the BUSY signal is OFF.**
- 2 Measurement begins and the BUSY signal is turned ON during the measurement process.**
- 3 At the same time or after the TRIG signal turns ON, the external device turns ON the DSA signal to request data transmission.*1**

*1 If you do not turn ON the DSA signal within the specified timeout time after measurements are completed, a timeout error will occur. (This is timeout time 1.)

- 4 When the measurement has been finished, the measurement result is output using an OR signal, and the BUSY signal is turned OFF.*2**

*2 You can also set the [BUSY output] parameter so that the BUSY signal is turned OFF after the completion of data logging, image logging, or displaying results.

- 5 The DSA signal is ON, and thus the D0 to D15 signals are output and the GATE signal turns ON.**
- 6 When the DSA signal is turned OFF, the GATE signal turns OFF.*3**

*3 If you do not turn OFF the DSA signal within the specified timeout time after the GATE signal turns ON, a timeout error will occur. (This is timeout time 2.)

- 7 If more than one data item is being output for one measurement and you do not turn ON the DSA signal within the specified timeout time after the GATE signal turns OFF, a timeout error will occur. (This is timeout time 3.)**

Offsetting the Timing of Outputting Measurement Results

The measurement result is output when the TRIG signal turns ON the number of times set for the [Number of delay] parameter.

This allows you to delay the output timing of the measurement result from the Sensor according to the actual processing timing of the line.

Example: Sequential Feed Line That Uses a Star Wheel

In a line like this, you can synchronize the output timing of the measurement results and the discharge timing of NG products that are detected.

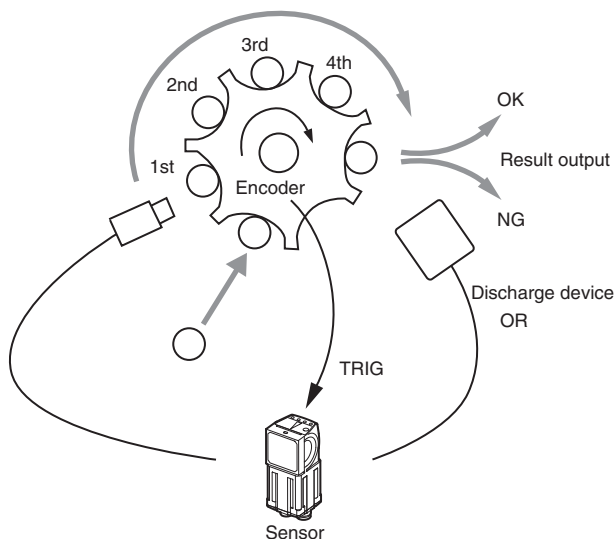

If you set the [Number of delay] parameter to 4, the measurement result output is delayed by four TRIG signals.

Note

- With synchronized output, the number of times that the TRIG signal turns ON is counted. Therefore, use synchronized output only when only one measurement result is output for each measurement. (Output either the parallel judgement or data.)
- Use a measurement trigger only for single measurements.
If you perform continuous measurements by inputting a command, the output timing will not be correct and the Sensor may malfunction.

● Timing Chart

Operation When [Number of Delay] Is Set to 2

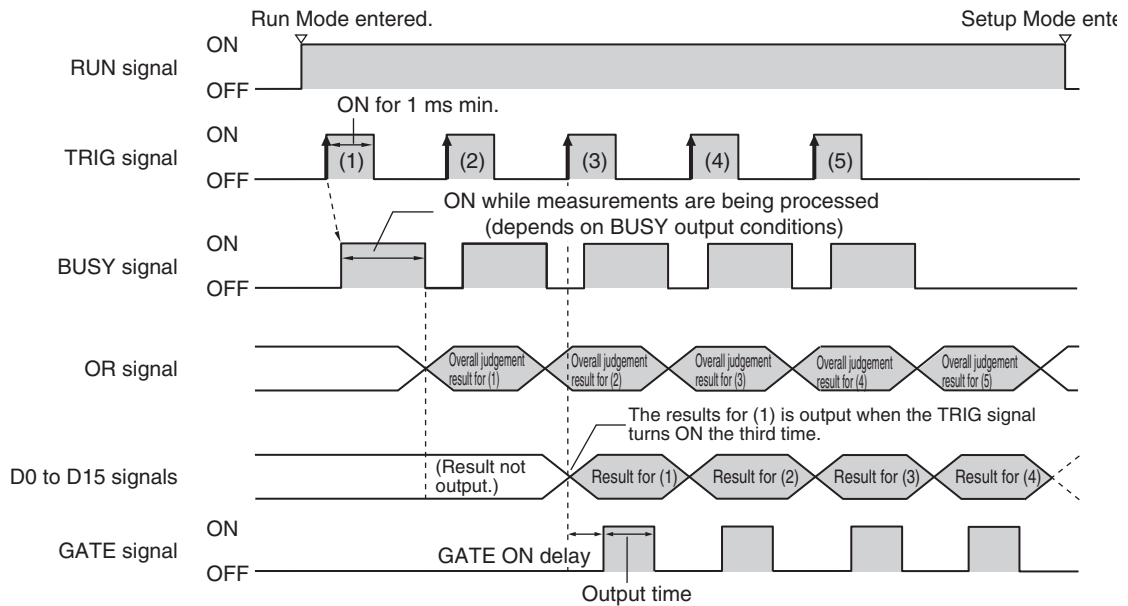

- 1** Repeatedly turn ON the TRIG signal while the BUSY signal is OFF.
- 2** The OR signal is output when the TRIG signal is turned ON.
- 3** When the TRIG signal turns ON for the third time, the measurement result (D0 to D15) for the first time that the TRIG signal turned ON is output and the GATE signal is also output at this time.
- 4** When the TRIG signal turns ON for the fourth time, the measurement result (D0 to D15) for the second time that the TRIG signal turned ON is output and the GATE signal is also output at this time.
- 5** Each time the TRIG signal turns ON after that, the measurement result (D0 to D15) from when the TRIG signal turned ON two times previously is output.

Changing the Settings of the I/O Signals

Changing the Settings of the Output Signals

● Adjusting the Judgement Output Timing

You can change the timing of outputting the measurement result with the OR signal (after finalizing the measurement result) according to the needs of the external device.

 Adjusting the Judgement Output Timing: p. 42

● Changing the Judgement Output ON Conditions

You change the ON condition for the OR signal to turn ON the signal when the judgement result is OK or when it is NG.

 Changing the Judgement Output ON Condition: p. 44

● Adjusting the End Timing of the BUSY Signal

You can change the end timing of the BUSY signal.

 Adjusting the End Timing of the BUSY Signal: p.45

● Changing the Output Polarity of the Output Signals

You can change the ON/OFF output polarity of the output signals

▶ **[In/Out] – [I/O setting] – [I/O] – [Output]**

1 Press [Output polarity] and select the ON/OFF polarity for all output signals.

Item	Parameter	Description
Output polarity	Positive (default) Negative	You can reverse the ON/OFF conditions of the output signals. For example, when the BUSY signal uses positive polarity, the signal is ON while the Sensor is processing something. If you change the setting to negative polarity, the Sensor will be ready to receive data or signals when the BUSY signal is ON. Applicable Output Signals <ul style="list-style-type: none">• RUN• OR• BUSY• ERROR• STGOUT• SHTOUT• DSA• GATE• D0 to D15• ACK

● Setting the Output Time of the ACK Signal

You can set the output time of the normal execution completion signal for parallel commands.

▶ **[In/Out] – [I/O setting] – [I/O] – [Output] – [ACK signal ON period]**

Important

The ACK signal is not output for normal completion of continuous measurement commands.

● Changing the Output Timing and Output Time of the STGOUT Signal

You can change the output settings of the STGOUT signal to adjust when and for how long the external lighting is lit.

► [Image] – [Camera setup] – [◀] – [Lighting control]

1 Change the setting for lighting control.

Item	Parameter	Setting	Description
Lighting control	Strobe output delay	0 to 65,535 μ s (default: 0 μ s)	Enter the delay time from when the TRIG signal is input until the external lighting is lit.
	Strobe output time	0 to 65,535 μ s (default: 1,000 μ s)	Set the pulse width of the output signal (STGOUT) that tells the external lighting when to light.

Important

When the strobe polarity is set to [Negative], a delay of about 200 to 300 μ s occurs from when the TRIG signal is input until the STGOUT signal goes low. When a high-speed shutter is used, set the [Output polarity] parameter to [Positive].

• Timing Chart for Strobe Trigger Output Signal

The STGOUT signal turns ON in sync with the trigger input signal from an external device.

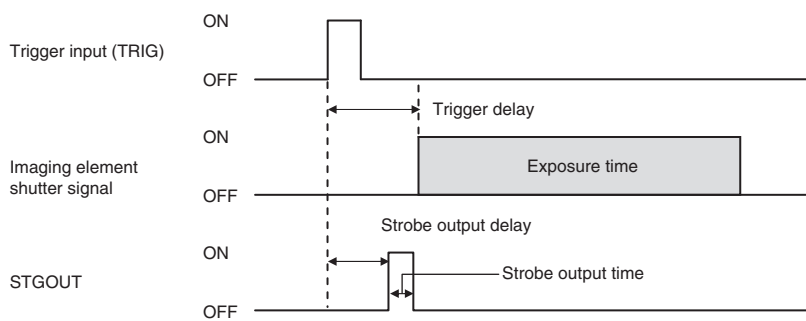

Polarity of all output signals: Positive

Controlling Operation from an External Device

The following Sensor functions can be controlled with command inputs from an external device without connecting the Touch Finder.

Operation	Description	Reference
Switching the scene	This command changes the scene when the line process changes.	p. 76
Clearing measurement values	This command clears the measurement values. The OR signal and D signals are not cleared.	p. 77
Clearing an error	This command turns the ERROR signal OFF. The ERROR indicator is also turned OFF.	p. 78
Re-registering the model and reference color	This command re-registers the model and reference color.	p. 80
Teaching	This command uses the image that is currently being input to execute teaching for all of the registered items.	p. 81
Clearing the OR and D signals	This command clears the OR signal and D signals.	p. 82
Saving data in the Sensor	This command saves the current settings (scene data and system data) in the Sensor.	p. 84
Retrying Inspection by External Signal (trigger retry)	This command continues inspection when the trigger signal is ON.	p. 85

Input Format (IN7 to IN0)



Changing the Scene

This command changes the scene to shift to a different process.

Parameters

Execution	Command	Input example						
IN7	IN6	IN5	IN4	IN3	IN2	IN1	IN0	
1	01	Input the scene number as a binary value.					10100001 (Changes to scene 1.)	

Timing Chart

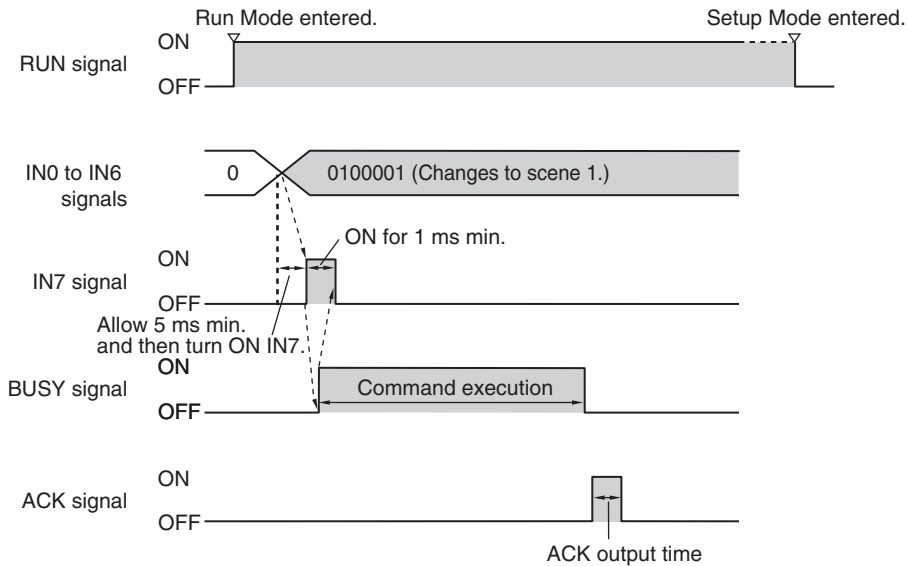

Output Signals

Signal	Function
RUN	This signal is ON while the Sensor is ready to take measurement and it is in Run Mode. It will be OFF in Setup Mode.
BUSY	This signal indicates that the Sensor is currently changing the scene. Do not input the next command while the BUSY signal is ON. The process that is currently being executed and the command that is input will not be executed correctly.
ACK	When the command has been completed normally, this signal is turned ON for the time that is set for the ACK output time.

Input Signals to Change the Scene

Signal	Function
IN0 to IN4	These signals specify the scene number (0 to 31).
IN5	Turn ON.
IN6	Turn OFF.
IN7	This signal functions as the execution trigger. Set the IN0 to IN6 signals, wait for at least 5 ms, and then turn ON the IN7 signal. The BUSY signal will be ON while the command is being executed.

Clearing Measurement Values

This command clears the measurement values.

Parameters

Execution	Command							Input example
IN7	IN6	IN5	IN4	IN3	IN2	IN1	IN0	
1	1000000							11000000

Timing Chart

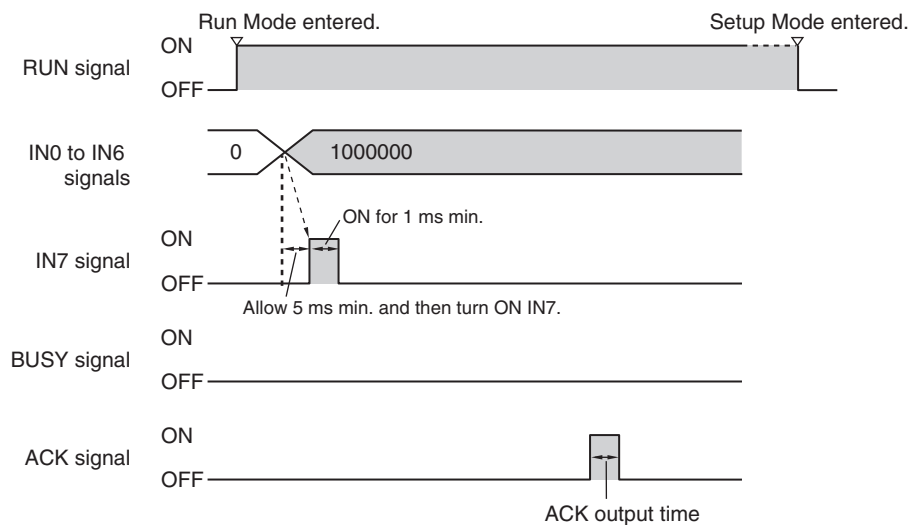

Output Signals

Signal	Function
RUN	This signal is ON while the Sensor is in Run Mode. It will be OFF in Setup Mode.
BUSY	This signal does not change while clearing measurement values.
ACK	When the command has been completed normally, this signal is turned ON for the time that is set for the ACK output time.

Input Signals

Signal	Function
IN0 to IN5	Turn OFF.
IN6	Turn ON.
IN7	This signal is the trigger for clearing measurement values. Set the IN0 to IN6 signals, wait for at least 5 ms, and then turn ON the IN7 signal.

Clearing an Error

This command clears the error output status.

Parameters

Execution	Command							Input example
IN7	IN6	IN5	IN4	IN3	IN2	IN1	IN0	
1	1000001							11000001

Timing Chart

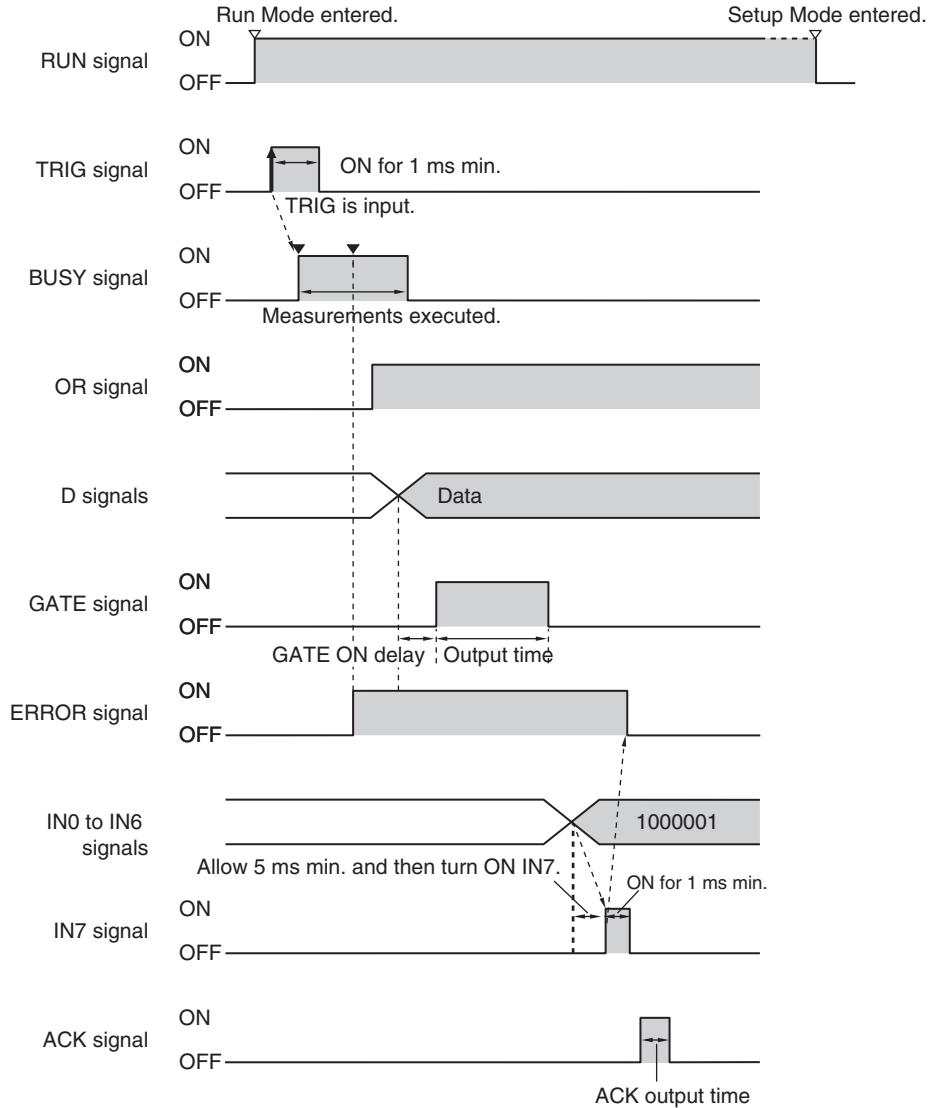

Output Signals

Signal	Function
RUN	This signal is ON while the Sensor is in Run Mode. It will be OFF in Setup Mode.
BUSY	This signal does not change while clearing errors. However, do not clear an error while the BUSY signal is ON. The command will not be executed correctly.
OR	This signal does not change while clearing errors.
D0 to D15	These signals do not change while clearing errors.
GATE	This signal does not change while clearing errors.
ACK	When the command has been completed normally, this signal is turned ON for the time that is set for the ACK output time.

Input Signals

Signal	Function
IN0	Turn ON.
IN1 to IN5	Turn OFF.
IN6	Turn ON.
IN7	This signal is the trigger for clearing an error. Set the IN0 to IN6 signals, wait for at least 5 ms, and then turn ON the IN7 signal.

Re-registering the Model and Reference Color

This command is input from an external devices, such as a PLC, to re-register the models and reference colors for registered inspection items based on the image that was just input.

Inspection items	Re-registered data
Search, Shape Search II, Sensitive Search, Search Position Compensation, and Shape Search Position Compensation	Models
Color Data	Reference color (hue, saturation, and brightness)
Edge Position, Edge Width, Edge Pitch, Area, and Labeling	None

Parameters

Execution	Command							Input example
IN7	IN6	IN5	IN4	IN3	IN2	IN1	IN0	
1	1001000							11001000

Timing Chart

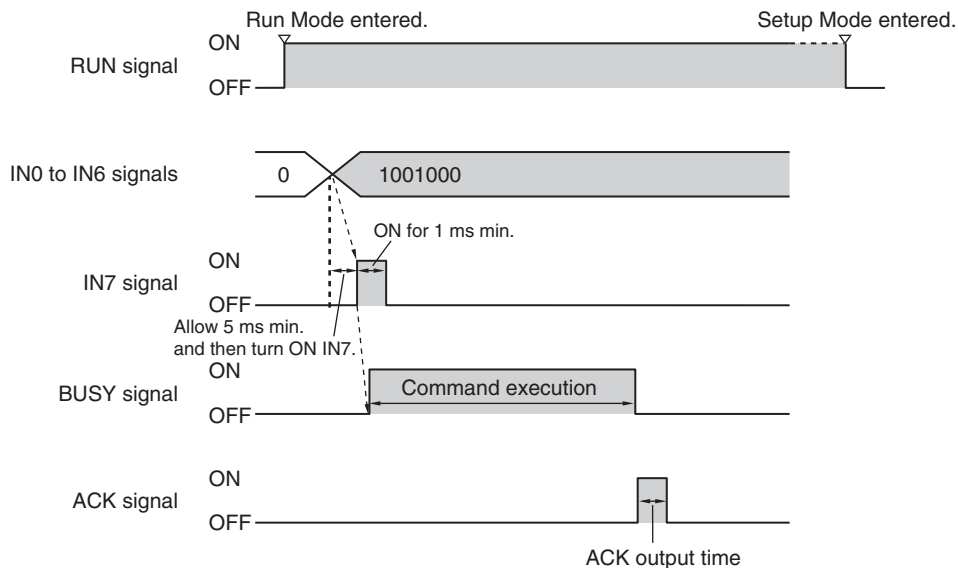

Output Signals

Signal	Function
RUN	This signal is ON while the Sensor is in Run Mode. It will be OFF in Setup Mode.
BUSY	This signal is ON during re-registration of the model and reference color.
ACK	When the command has been completed normally, this signal is turned ON for the time that is set for the ACK output time.

Input Signals

Signal	Function
IN0 to IN2	Turn OFF.
IN3	Turn ON.
IN4 and IN5	Turn OFF.
IN6	Turn ON.
IN7	This signal is the trigger for executing re-registration of the model and reference color. Set the IN0 to IN6 signals, wait for at least 5 ms, and then turn ON the IN7 signal. The BUSY signal will be ON while the command is being executed.

Teaching

This command executes teaching for all registered items (excluding Edge Pitch) using the current input image.

Parameters

Execution	Command							Input example
IN7	IN6	IN5	IN4	IN3	IN2	IN1	IN0	
1	1001001							11001001

Timing Chart

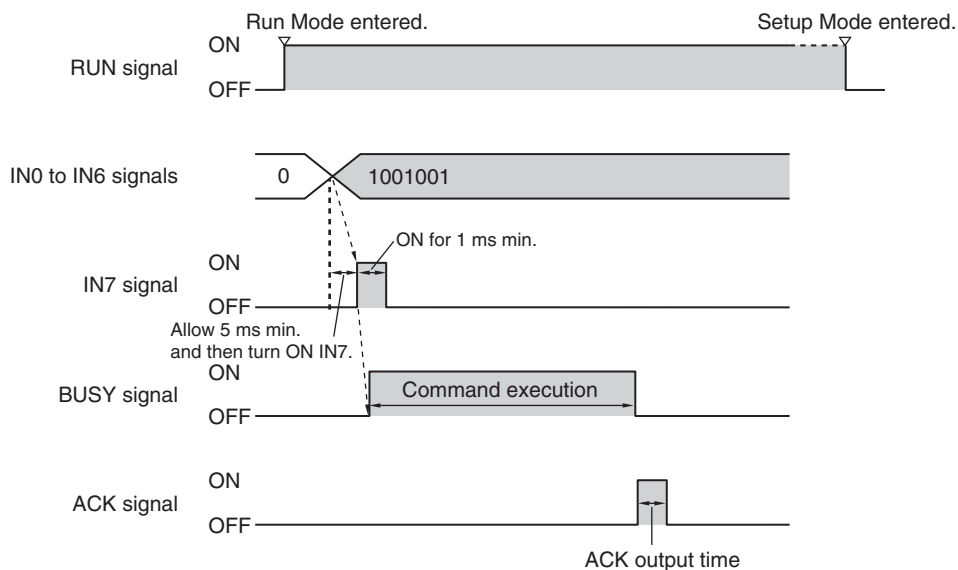

Output Signals

Signal	Function
RUN	This signal is ON while the Sensor is in Run Mode. It will be OFF in Setup Mode.
BUSY	This signal is ON while teaching is being executed.
ACK	When the command has been completed normally, this signal is turned ON for the time that is set for the ACK output time.

Input Signals

Signal	Function
IN0	Turn ON.
IN1 and IN2	Turn OFF.
IN3	Turn ON.
IN4 and IN5	Turn OFF.
IN6	Turn ON.
IN7	This signal is the trigger for executing teaching. Set the IN0 to IN6 signals, wait for at least 5 ms, and then turn ON the IN7 signal. The BUSY signal will be ON while the command is being executed.

Clearing the OR and D Signals

This command clears the OR signal and D signals.

Parameters

Execution	Command							Input example
IN7	IN6	IN5	IN4	IN3	IN2	IN1	IN0	
1	1000010							11000010

Timing Chart

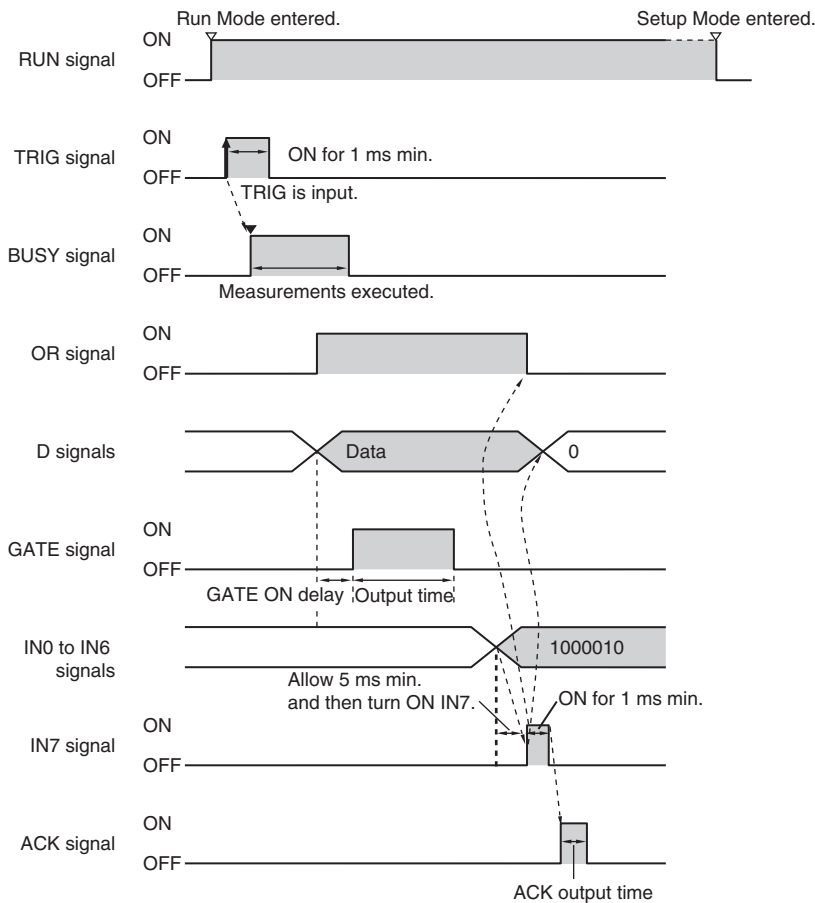

Output Signals

Signal	Function
RUN	This signal is ON while the Sensor is in Run Mode. It will be OFF in Setup Mode.
BUSY	This signal does not change while clearing the OR and D signals. However, do not clear the OR and D signals while the BUSY signal is ON. The command will not be executed correctly.
OR	If this signal was ON, it will be turned OFF.
D0 to D15	If these signals were ON, they will be turned OFF.
GATE	This signal does not change while clearing the OR and D signals. However, do not clear the OR and D signals while the GATE signal is ON. The command will not be executed correctly. Also, the D and GATE outputs may not function correctly.
ACK	When the command has been completed normally, this signal is turned ON for the time that is set for the ACK output time.

Input Signals

Signal	Function
IN0	Turn OFF.
IN1	Turn ON.
IN2 to IN5	Turn OFF.
IN6	Turn ON.
IN7	This signal is the trigger for clearing the OR and D signals. Set the IN0 to IN6 signals, wait for at least 5 ms, and then turn ON the IN7 signal.

Saving Data in the Sensor

This command saves the current settings (scene data and system data) in the Sensor.

Parameters

Execution	Command							Input example
IN7	IN6	IN5	IN4	IN3	IN2	IN1	IN0	
1	1010000							11010000

Timing Chart

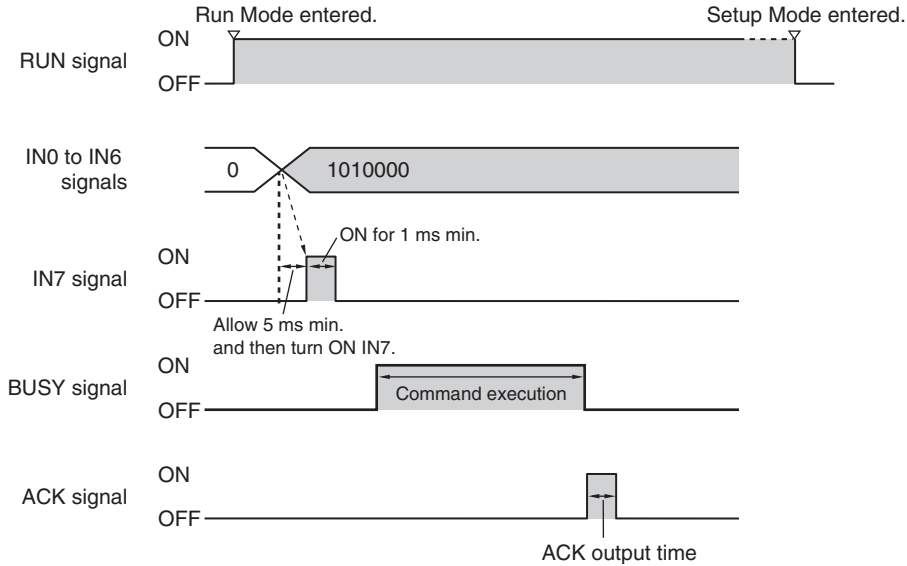

Output Signals

Signal	Function
RUN	This signal is ON while the Sensor is in Run Mode. It will be OFF in Setup Mode.
BUSY	This signal will be ON while data is being saved in the Sensor.
ACK	When the command has been completed normally, this signal is turned ON for the time that is set for the ACK output time.

Input Signals

Signal	Function
IN0 to IN3	Turn OFF.
IN4	Turn ON.
IN5	Turn OFF.
IN6	Turn ON.
IN7	This signal is the trigger for saving data in the Sensor. Set the IN0 to IN6 signals, wait for at least 5 ms, and then turn ON the IN7 signal.

Retrying Inspection by External Signal (Trigger Retry)

Measurement is repeated until all inspection items have been successfully scanned.

Retry inspection ends when any one of the following conditions is satisfied:

- (1) The scanning result of all inspection items is OK.
- (2) Trigger retry (this command) turns OFF.
- (3) The timeout time is exceeded.

Note

- This function can be used in Run Mode only.

Parameters

Execution	Command							Input example
IN7	IN6	IN5	IN4	IN3	IN2	IN1	IN0	
1	0001100							10001100

Timing Chart

- When inspection is OK

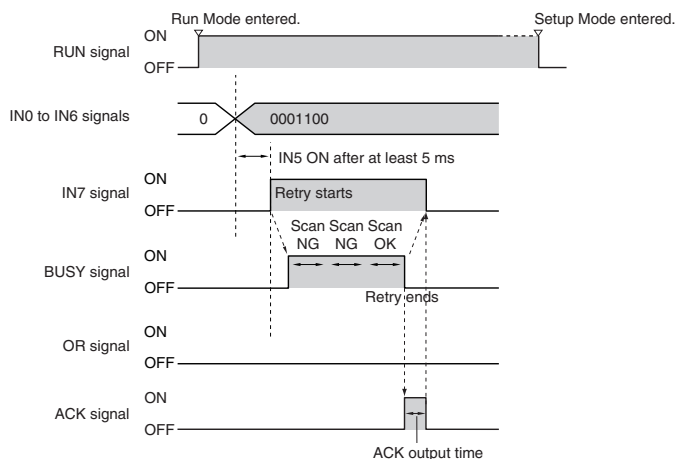

- 1 Set the IN0 to IN6 signals.
- 2 When IN5 is turned OFF > ON with the BUSY signal OFF, trigger retry inspection starts.
- 3 When retry inspection starts, the BUSY signal turns ON.
- 4 When the overall judgment turns ON, retry inspection ends and the BUSY signal turns OFF.
- 5 After verifying that the BUSY signal has turned ON > OFF, IN5 is turned ON > OFF.

• When inspection is NG

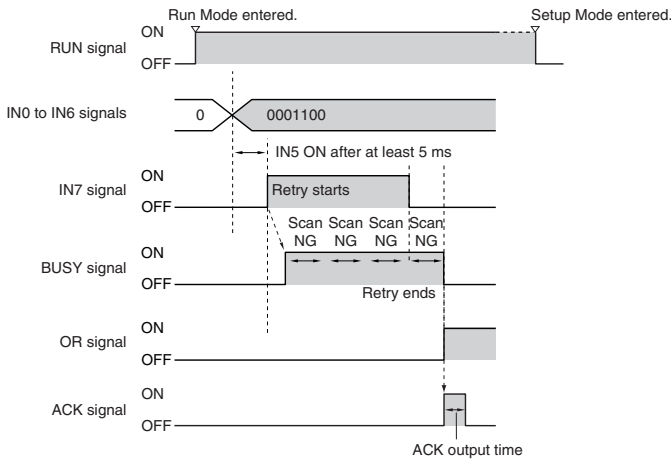

- 1 Set the IN0 to IN6 signals.
- 2 When IN5 is turned OFF > ON with the BUSY signal OFF, trigger retry inspection starts.
- 3 When retry inspection starts, the BUSY signal turns ON.
- 4 IN5 is turned OFF and retry inspection ends. If retry inspection ends but the overall judgment is NG, the OR signal turns ON. (Output polarity: When ON at NG)

Output Signals

Signal	Function
RUN	This signal is ON while the Sensor is in Run Mode. It will be OFF in Setup Mode.
BUSY	This signal is ON while measurements are being processed (depends on BUSY output conditions).
OR	The overall judgement result is output from this signal.
ACK	When the command has been completed normally, this signal is turned ON for the time that is set for the ACK output time.

Input Signals

Signal	Function
IN0 to IN6	With these signals, user (PLC) sets the commands.
IN7	This signal is the trigger for Trigger Retry. Set the IN0 to IN6 signals, wait for at least 5 ms, and then turn ON the IN7 signal. The BUSY signal will be ON while the command is being executed.

Note

The time the BUSY signal is ON is the trigger retry execution time.

Important

It may happen that the PLC is unable to recognize BUSY signal ON because the sample time is slow or otherwise. In this event, have W0.00 turn OFF at a suitable time.

Controlling Operation and Outputting Data with an Ethernet Connection

3-1 Controlling Operation and Outputting Data with EtherNet/IP Communications.	88
3-2 Controlling Operation and Outputting Data with PLC Link Communications.	121
3-3 Outputting Data and Controlling Operation through PROFINET . . .	140
3-4 Control and Output in No-Protocol (TCP) / No-Protocol (UDP)	167
3-5 Controlling Operation and Outputting Data with FINS/TCP No-protocol Commands.	188

3-1 Controlling Operation and Outputting Data with EtherNet/IP Communications

FQ2-S1

FQ2-S2

FQ2-S3

FQ2-S4

FQ2-CH

Introduction to EtherNet/IP

EtherNet/IP is an industrial multi-vendor network that uses Ethernet.

The EtherNet/IP specifications are open standards managed by the ODVA (Open DeviceNet Vendor Association). EtherNet/IP is used by a wide range of industrial devices.

Because EtherNet/IP uses standard Ethernet technology, various general-purpose Ethernet devices can be used in the network.

EtherNet/IP has mainly the following features.

- High-speed, High-capacity Data Exchange through Tag Data Links

The EtherNet/IP protocol supports implicit communications, which allows cyclic communications called tag data links with EtherNet/IP devices.

- Tag Data Links at Specified Communications Cycle for Each Application Regardless of the Number of Nodes

Tag data links (cyclic communications) operate at the cyclic period that is specified for each application, regardless of the number of nodes. Data is exchanged over the network at the refresh cycle that is set for each connection. The communications refresh cycle will not increase even if the number of nodes is increased, i.e., the concurrency of the connection's data is maintained.

Because the refresh cycle can be set for each connection, each application can communicate at its ideal refresh cycle. For example, interprocess interlocks can be transferred at high speed, while the production commands and the status monitor information are transferred at low speed.

Important

On a network to which many devices are connected, performance may drop (e.g., responses may be delayed or packets lost) or communications errors may occur when there is temporarily high traffic on the network. Test the operation under actual conditions before you start actual operation of the system.

Data Exchange with EtherNet/IP

Data is exchanged cyclically between Ethernet devices on the EtherNet/IP network using tag data links as shown below.

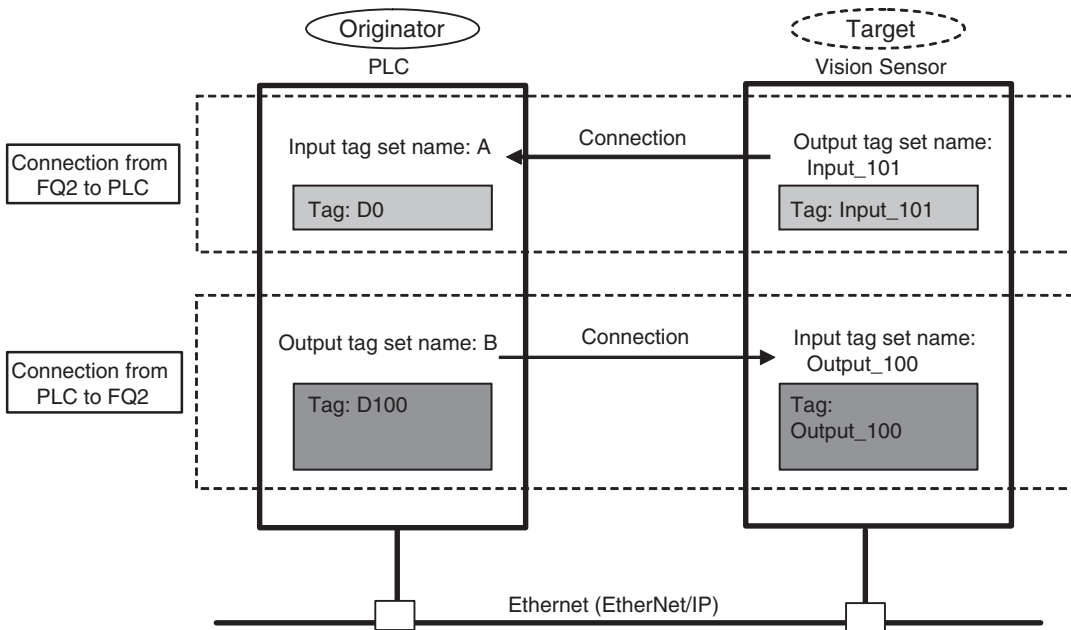

● Data Exchange Method

To exchange data, a connection is opened between two EtherNet/IP devices.

One of the nodes requests the connection to open a connection with a remote node.

The node that requests the connection is called the originator, and the node that receives the request is called the target.

● Data Exchange Memory Locations

The memory locations that are used to exchange data across a connection are specified as tags.

You can specify memory addresses or variables for tags.

A group of tags consists of an output tag set and an input tag set.

Note

To communicate by EtherNet/IP with a PLC that does not support tag data link communication, use the message communication function rather than tag data link.



Communicating with the Sensor Controller with EtherNet/IP Message Communications: p.120

FQ2 Communications for EtherNet/IP Connections

You can use EtherNet/IP tag data links to communicate between the PLC and the Vision Sensor to perform control via command/response communications or to output data after measurements.

The FQ2 complies with EtherNet/IP conformance test version A10.

To connect to OMRON Controllers and communicate through EtherNet/IP, you use the Network Configurator to set up tag data links (i.e., tags, tag sets, and connection settings).

Refer to the following manuals for details on the tag data link settings that are made with the Network Configurator.

- NJ-series CPU Unit Built-in EtherNet/IP Port User's Manual (Cat. No. W506)
- CS/CJ-series EtherNet/IP Units Operation Manual (Cat. No. W465)
- CJ-series EtherNet/IP Units Operation Manual for NJ-series CPU Unit (Cat. No. W495)

Types of Communications Areas

For EtherNet/IP communications, the following three communications areas are used in the PLC to perform communications.

Areas Used for the Different Control Methods

Command/response communications	(1) Command area	This is the area to which you write control commands for the Vision Sensor to execute.
	(2) Response area	This is the area to which the Vision Sensor writes the results of control commands executed from the command area.
Data output after measurements	(3) Output area	This is the area to which the Vision Sensor writes output data for measurements after an inspection is performed.

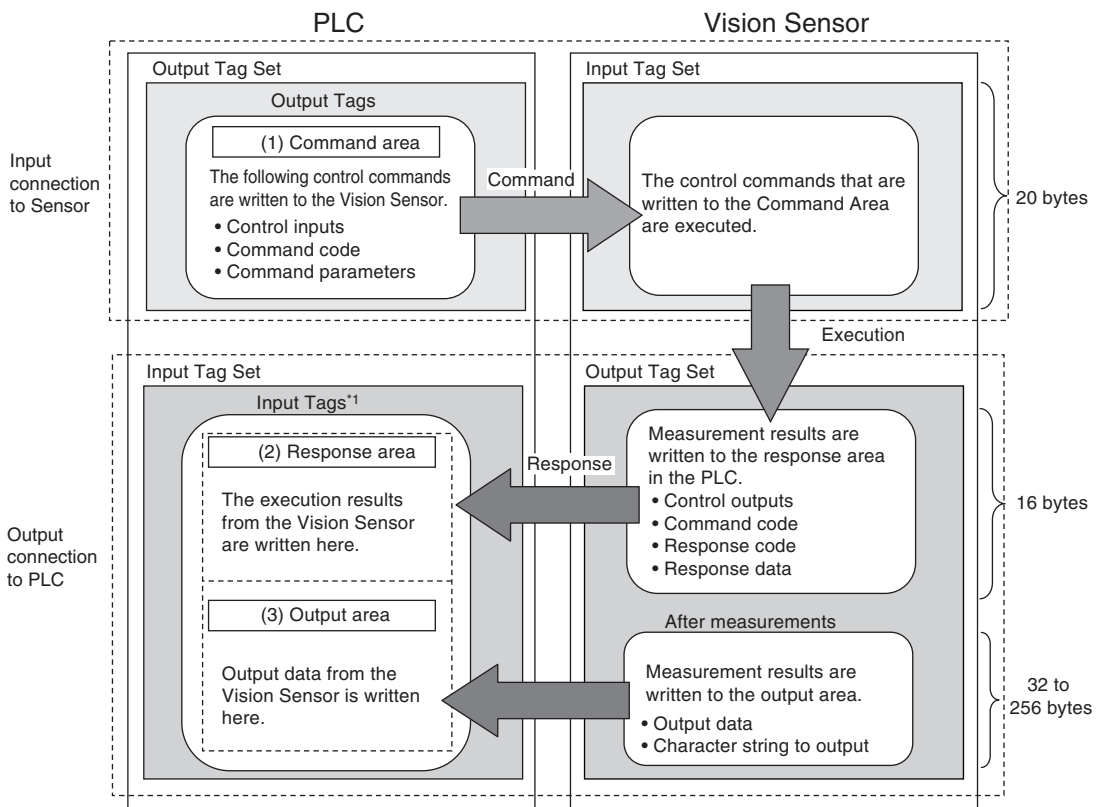

*1: The response area (2) and output area (3) are assigned to continuous memory addresses or to a variable.

Setting Up EtherNet/IP Communications

Setting Network Settings in the Sensor

Set the IP address of the Sensor according to the network where the external devices, such as PLCs, are connected.

▶  (Setup Mode) – [Sensor settings] – [Network] – [Ethernet] – [IP address setting]

- 1 Press [Fixed].
- 2 Set the IP address and subnet mask according to the network where the external devices, such as PLCs, are connected.

Note

If you connect OMRON CS/CJ-series PLCs to the Ethernet, the following default IP addresses are assigned to the PLCs.

- IP address: 192.168.250.*node_address*

Important

To use EtherNet/IP communications, do not automatically assign an IP address to the Vision Sensor. Set a specific IP address and do not change it.

Initial Settings for EtherNet/IP Communications

▶  (Setup Mode) – [Sensor settings] – [Data output] – [Link data output]

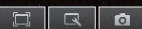

- 1 Press [Communication type].
- 2 Press [EtherNet/IP].
- 3 Set the EtherNet/IP communications parameters as described in the following table.

[Output handshake] Set to [Yes]

Link data output	
Communication type	EtherNet/IP
Handshake setting	Yes
Output data size	32 bytes
Communication cycle	10
Timeout	100
	
Back	

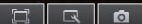
[Output handshake] Set to [No]

Link data output	
Communication type	EtherNet/IP
Handshake setting	No
Output data size	32 bytes
Communication cycle	10
Data output period	40
GATE signal ON period	20
	
Back	

Parameter	Description	Setting range
Output handshake	<p>Set whether to synchronize with the PLC when data is output.</p> <p>No: Measurement results are output without synchronizing with the PLC.</p> <p> Data Output after Measurements When Handshaking Is Disabled: p. 117</p> <p>Yes: Measurement results are output while synchronizing with the PLC.</p> <p> Data Output after Measurements When Handshaking Is Enabled: p. 117</p>	<ul style="list-style-type: none"> • Yes • No (default: Yes)
Output data size	<p>Set the data size to output from the output area. Any changes in the setting are applied when the Sensor is restarted.</p> <p>Note</p> <p>If the total size of the data that is specified as output data exceeds the size that is set here, all of the data will not be output at the same time, but will be separated over more than one cycle.</p> <p> Output Data Size and Number of Output Data Upper Value Setting: p. 25</p> <p>Important</p> <p>Set the input connection (input tag set) to 16 bytes greater than the size that you set for this parameter.</p>	32 bytes, 64 bytes, 128 bytes, or 256 bytes (default: 32 bytes)

Parameter	Description	Setting range
Refreshing task period	<p>Set the communications cycle for cyclic tag data link communications for the Vision Sensor. Set the same value as you set for the requested packet interval (RPI) on the Network Configurator.</p> <p>Important</p> <ul style="list-style-type: none"> • Set this parameter to the same value as you set for the requested packet interval (RPI) in the PLC. • This parameter is necessary for the FQ2 to synchronize with the communications cycles of the cyclic tag data link communications that are set for tag connections on the Network Configurator and in the PLC. • If the value in the FQ2 is longer than the value in the PLC, cyclic data exchange will not be performed according to the expected communications cycle. • The smaller the setting of this parameter is, the more the measurement processing time will be affected. For the lowest setting of 1 ms, the processing time will increase by approximately 5% to 10%. 	1 to 10,000 ms (default:10 ms)
Timeout	<p>This parameter is displayed and can be set only when [Output handshake] is set to [Yes]. A timeout error will occur if there is no response from the PLC within the time that is set.</p> <ul style="list-style-type: none"> • From when measurements are completed until the DSA Bit turns ON • From when the GATE flag turns ON until the DSA Bit turns OFF • From when the GATE flag turns OFF until the DSA Bit turns ON 	0.1 to 120.0 s (default: 10.0 s)
Data output period	<p>This parameter is displayed and can be set only when [Output handshake] is set to [No]. Set the period for outputting measurement results.</p> <p>Important</p> <p>Set a value that is longer than the GATE ON output time and shorter than the measurement interval of the Sensor.</p>	2 to 5,000 ms (default: 40 ms)
GATE signal ON period	<p>This parameter is displayed and can be set only when [Output handshake] is set to [No]. Set the time to turn ON the GATE signal. Set the time that is required for the PLC to read the measurement results.</p> <p>Important</p> <p>Set the cycle time of the PLC so that it is longer than the packet interval (RPI).</p>	1 to 1,000 ms (default: 20 ms)

Tag Data Link Setting Methods

This section describes how to set data links for EtherNet/IP.

The communications areas in the PLC for which data links are created to the Sensor are specified as tags and tag sets, and the connections are set for tag data link communications.

Tags, tag sets, and connections are set from the Network Configurator.

Refer to the following manuals for details on the tag data link settings that are made with the Network Configurator.

- NJ-series CPU Unit Built-in EtherNet/IP Port User's Manual (Cat. No. W506)
- CS/CJ-series EtherNet/IP Units Operation Manual (Cat. No. W465)
- CJ-series EtherNet/IP Units Operation Manual for NJ-series CPU Unit (Cat. No. W495)

Important

- To connect the FQ2 to an NJ/CJ-series CPU Unit, install the EDS file that defines the connection information for the FQ2 in the Network Configurator. Download the EDS file from the OMRON website.
- After tag data links are set, the Vision Sensor will automatically be restarted to enable the settings.

Tags, Tag Sets, and Connection Settings

The communications areas in the PLC are set as tag data link connections as shown in the following table.

- Tag and Tag Set Settings in the PLC

Parameter	Settings	
	Command area	Response area and output area
Type of tags and tag set	Output tag set	Input tag set
Tag and tag set names	I/O memory addresses or variable names	I/O memory addresses or variable names ^{*1}
Data size	20 bytes	48 to 272 bytes (total size of response area and output area)

^{*1} Specify the I/O memory address of the first word in the response area.
 The output area is assigned immediately after the response area.
 If you specify a variable name, the variable is assigned for both the response area and output area.
 Refer to Accessing Communications Areas Using Variables with NJ-series Controllers on p. 105 for information on how to access the signals in the communications areas from the user program when variables are assigned.

● Settings in the FQ2 (Device Parameter Settings)

- 1 Right-click the FQ2 in the network on the Network Configurator and select [Parameter] – [Edit].
- 2 The Edit Device Parameters Dialog Box will be displayed. Make the required settings.

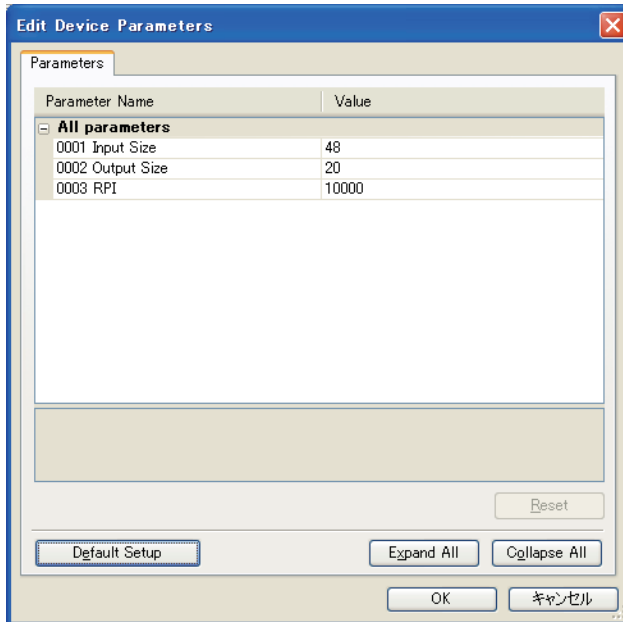

Parameter name	Value	Setting range
001 Input Size ^{*1}	The total size of response area and output area	48 to 272
002 Output Size ^{*2}	The data size of command area	20
003 RPI ^{*3}	The requested packet interval	10000

- *1 Although the data size can be set as high as 502 bytes, with the current version set one of the following as the total data size for the output area (data output size) and the response area (16 bytes).
- 48 bytes (default)
 - 80 bytes
 - 144 bytes
 - 272 bytes
- *2 Although the data size can be set as high as 502 bytes, with the current version use the default setting of 20 bytes.
- *3 The packet interval (RPI) is set in the connection settings between the PLC and the Sensor. No setting is required here.

● Connection Settings

Parameter	Setting	
Originator device (PLC)	Input tag set	<i>PLC_tag_set_name</i> -[**Byte] **: This is the total size of the response area and output area that you set.
	Connection type	Any (default: multi-cast connection) ^{*1}
	Output tag set	<i>PLC_tag_set_name</i> -[20Byte]
Target device (Vision Sensor)	Output tag set	Input_101-[**Byte] **: This is the total size of the response area and output area that you set.
	Input tag set	Output_100-[20Byte]
Packet interval (RPI)	Any (default: 20.0) ^{*2}	

- *1 If multi-cast connections are used, however, use an Ethernet switch that has multi-cast filtering, unless the tag set is received by all nodes in the network.
- *2 Set the same value as you set for the refreshing task period in the EtherNet/IP communications settings.

Important

- If I/O memory addresses are specified for the communications areas, the information in the communications areas will be cleared when the operating mode of the PLC changes unless addresses in the CIO Area, which are maintained, are specified.
- The following assembly object is required to specify instances when the EDS file is not used.

Assembly Object Settings

Parameter name	Setting	Remarks
Instance ID	100	Output connection
	101	Input connection

Setting the Data to Output Automatically after Measurements

You can specify the measurement data to output automatically to the PLC after measurements.

Data That Can Be Output

- Data Output

On the FQ2, data that is output after measurement can be assigned to Data 0 to Data 31 in the output data settings.

When an item is assigned to an output data setting, the data is output in units of four bytes per item.

The maximum data size that can be output at once is 256 bytes.

Note

If multiple inspection results are assigned to one output data setting, that output data setting will be set for more than four bytes of data output. As a result, it is possible that an item that exceeds the data size (256 bytes) that can be output at once will be set in the data output setting. In this case, the output will be divided and output over multiple cycles.



Output Data Size and Number of Output Data Upper Value Setting: p. 25

The measurement data from inspection items that can be output and the calculation results from the expression settings can be output.

For data that can be output, refer to the *Measurement Data That Can Be Used for External Outputs and Calculations* for each inspection item.



Assigning Detection Results to Output Data: p. 98

Assigning More Than One Detection Result to Output Data: p. 98

- Outputting Character Strings (Only supported on the FQ2-S4/CH)

You can output a character string for each of the inspection items that reads a character string, such as the OCR inspection item. Also, when reading the character string fails, you can output a specific character string that is set in advance.



Outputting Read Character Strings: p. 101

Assigning Inspection Results to Output Data

You can individually assign the parameters of the inspection items to output data (data 0 to data 31). The following procedure shows how to assign the measured position X of [0. Search] to data 0 for a binary output.

▶ **[In/Out] – [I/O setting] – [Output data setting] – [Link data output/Fieldbus data output] – [Output data set]**

- 1** Press [0. Data 0].
- 2** Press [Data setting].
- 3** Press [I0. Search].
- 4** Press [Position X X].

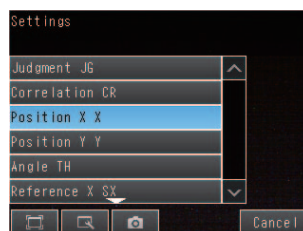

- 5** If the inspection item allows multi-point output, press the number ([0] to [31]) of the inspection result for which to output the data from the list of inspection results.

To register something to data 1 and higher, repeat this process. The settings will be enabled after you restart the Sensor.

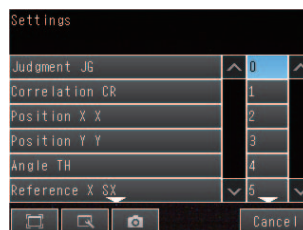

Assigning More Than One Inspection Result to the Same Output Data

You can assign more than one inspection result to the same data output to output all of the assigned results. This is possible for the following inspection results.

- Parameters for the same inspection item: You can assign up to five inspection results.
- Inspection results that support multi-point output: You can assign inspection results within the specified range (0 to 31).

The following procedure shows how to assign more than one inspection result to data 0.

▶ **[In/Out] – [I/O setting] – [Output data setting] – [Link data output/Fieldbus data output] – [Output data set]**

- 1** Press [0. Data 0].
- 2** Press [Multi-data setting].

3 Set the following items on the display to set expressions.

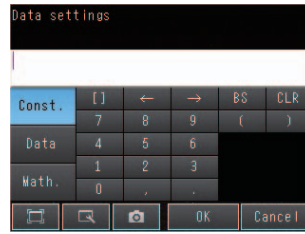

Item	Description
Expression	Register the expression to use to output multiple data. Examples: LPR (0, 3, I0.X, I0.Y) LPC (0, I0.C, I0.X, I0.Y)
Const.	Used to insert numbers and symbols into the expression.
Data	Used to select the inspection items for which to output data and insert the parameters to output into the expression. Example: Selecting Parameters for the Search Item at Inspection Item 0 Inspection item: I0. Search Judgement result: Judgement JG, Correlation: Corre. CR
Math.	Either of the following two functions can be inserted. <ul style="list-style-type: none"> LPR function (order of the measurement data) The measurement data is output in order. Format: LPR(<i>start_number</i>,<i>number_of_data</i>,<i>data_1</i>, <i>data_2</i>,...<i>data_5</i>) You can omit data 2 to data 5. LPC function (order of the detection points) Data is output for each detected measurement point. Format: LPC(<i>start_number</i>,<i>number_of_data</i>,<i>data_1</i>, <i>data_2</i>,...<i>data_5</i>) You can omit data 2 to data 5.

To register something to data 1 and higher, repeat this process.
The settings will be enabled after you restart the Sensor.

● Expression Setting Example

This example registers an expression to output the following inspection results for data 0.
Inspection item: 0 Search
Parameters to output: Position X, Position Y, Reference SX, and Reference SY
Multi-point output setting: Multi-point output Check Box selected, Count = 4

LPR(0,I0.C,I0.X,I0.Y,I0.SX,I0.SY)

Function | Number_of_data (Detection count) | data_A, data_B...data_d | Start_number

Output Results

The expression that is registered for data 0 assigns the data for 16 items (64 bytes) in the output area as shown below.

Output area data	Assigned data
Output data 0 (4 bytes)	I0.X[0] (Position X 1st point)
Output data 1 (4 bytes)	I0.Y[0] (Position Y 1st point)
Output data 2 (4 bytes)	I0.SX[0] (Reference SX 1st point)
Output data 3 (4 bytes)	I0.SY[0] (Reference SY 1st point)
Output data 4 (4 bytes)	I0.X[1] (Position X 2nd point)
Output data 5 (4 bytes)	I0.Y[1] (Position Y 2nd point)
Output data 6 (4 bytes)	I0.SX[1] (Reference SX 2nd point)
Output data 7 (4 bytes)	I0.SY[1] (Reference SY 2nd point)
Output data 8 (4 bytes)	I0.X[2] (Position X 3rd point)
Output data 9 (4 bytes)	I0.Y[2] (Position Y 3rd point)
Output data 10 (4 bytes)	I0.SX[2] (Reference SX 3rd point)
Output data 11 (4 bytes)	I0.SY[2] (Reference SY 3rd point)
Output data 12 (4 bytes)	I0.X[3] (Position X 4th point)
Output data 13 (4 bytes)	I0.Y[3] (Position Y 4th point)
Output data 14 (4 bytes)	I0.SX[3] (Reference SX 4th point)
Output data 15 (4 bytes)	I0.SY[3] (Reference SY 4th point)

Note

- The inspection results will be output according to the sorting method that is set for multi-point output for the inspection item.
- In order to output multiple detection results of the inspection items that can be output their results simultaneously, from the [Inspection] menu of the targeted inspection item, press [Multi-point output] and select [Yes].

Setting the Output Format

▶ [In/Out] – [I/O setting] – [Output data setting] – [Link data output/Fieldbus data output]

- 1** Press [Output format].
- 2** Press [Output form].
- 3** Set either a floating point decimal or a fixed decimal for the output form.

Item	Description	Setting range
Output form	Set the output form for numerical data. Fixed decimal point Outputs the data as a x1000 value. Example: 123.456 is output as 0x0001E240 Floating decimal point Outputs the data in floating point decimal format. Example: -123.4567 is output as 0xc2f6e979	Floating point or fixed point (default: Floating point)

Outputting Character Strings (Only supported on the FQ2-S4/CH)

You can set whether to output the character string that results from reading. Outputting the character string is possible for the following inspection results.

- OCR
- Bar code
- 2D-code
- 2D-code (DPM)

The procedure for outputting the character string is given here for two inspection items.

▶ **[In/Out] – [I/O setting] – [Output data set] – [Link data output/Fieldbus data output] – [Output data set]**

- 1** Select the inspection item for which to output the character string.
- 2** Set the following items on the setting display.

Parameter	Setting	Description
String output ON/OFF	OFF (default) Yes	Sets whether to output the character string that results from reading.
Partial output ON/OFF	No (default) Yes	Sets whether to specify the range of characters to output.
Output string setup	1 to 128 for OCR 1 to 1024 for Bar code, 2D-code, or 2D-code (DPM)	Sets the output range.
NG String output on/off	Yes (default) No	Sets whether to output an NG string.

Note

- Endian
Little endian data is output.
- Code Conversion
The converted codes are outputted for the following character codes.

Character code	Before conversion	After conversion
CR	&h0D	&h8541
LF	&h0A	&h8542
DEL	&h7F	&h8543
FF	&hFF	&h8544

Memory Assignments and Commands

Memory Assignments

This section describes the assignments of the command area for the input connection to the Sensor and the response and output areas for the output connection to the PLC.

● Input Connection to Sensor (PLC Originator to Vision Sensor Target)

• Command Area

	Bits																Contents
	15	14	13	12	11	10	9	8	7	6	5	4	3	2	1	0	
+0	ERCLR	Resv	Resv	Resv	Resv	Resv	Resv	Resv	Resv	Resv	Resv	Resv	Resv	Resv	TRIG	EXE	Control signals (32 bits)
+1	Resv	Resv	Resv	Resv	Resv	Resv	Resv	Resv	Resv	Resv	Resv	Resv	Resv	Resv	Resv	DSA	Control signals (32 bits)
+2	Command code																Command code (32 bits)
+3																	
+4	Parameter 1																Parameter 1 (32 bits)
+5																	
+6	Parameter 2																Parameter 2 (32 bits)
+7																	
+8	Parameter 3																Parameter 3 (32 bits)
+9																	

Signal	Signal name	Function	Application method
EXE	Control Command Execution Bit	Turn ON this signal from the PLC to send a control command for the Vision Sensor to execute. Set the control command code and parameters before you turn ON this signal.	Command/response communications
		Turn OFF the EXE signal from the PLC when the Control Command Completed (FLG) signal from the Vision Sensor turns ON.	
TRIG	Execute Measurement	Turn ON this signal from the PLC to send a command to execute a measurement.	Command/response communications
		This signal returns to OFF when the Command Execution Active (BUSY) signal goes ON.	
DSA	Data Output Request Bit * This bit can be used only when handshaking is enabled.	Turn ON this signal from the PLC to request data output. When this signal turns ON, the Vision Sensor outputs data.	Data output after measurements
		Turn OFF the DSA signal from the PLC when the Data Output Completed (GATE) signal from the Vision Sensor turns ON.	
ERCLR	Clear Error	Turn ON this signal to turn OFF the error (ERR) signal from the Vision Sensor.	Command/response communications
		Turn OFF this signal from the PLC when the error (ERR) signal goes OFF.	

Signal	Signal name	Function	Application method
Command code	Command code	This I/O port stores the command code.	Command/ response communications
Parameters 1 to 3	Command parameters	These I/O ports store the command parameters.	

● Output Connection to PLC (Vision Sensor Originator to PLC Target)

• Response Area

	Bits																Contents
	15	14	13	12	11	10	9	8	7	6	5	4	3	2	1	0	
+0	ERR	Resv	Resv	Resv	Resv	Resv	Resv	Resv	Resv	Resv	Resv	RUN	OR	READY	BUSY	FLG	Vision Status Flags (32 bits)
+1	Resv	Resv	Resv	Resv	Resv	Resv	Resv	Resv	Resv	Resv	Resv	Resv	Resv	Resv	Resv	GATE	
+2	Command code																Command code (32 bits)
+3																	
+4	Response code																Response code (32 bits)
+5																	
+6	Response data																Response data (32 bits)
+7																	

Signal	Signal name	Function	Application method
FLG	Control Command Completed	This signal turns ON when the Vision Sensor completes execution of the control command. (This signal turns ON after the control command code, response code, and response data have been stored.)	Command/ response communications
		This signal automatically turns OFF when the Control Command Execution Bit (EXE) is turned OFF by the user (PLC).	
BUSY	Command Execution Active	This signal is ON while the Vision Sensor cannot execute a control command.	Command/ response communications
		This signal is OFF while the Vision Sensor can execute a control command.	
READY	Trigger Input Ready	This signal turns OFF when the Vision Sensor cannot execute a control command.	Command/ response communications
		This signal turns ON when the Vision Sensor can execute a control command.	
OR	Overall judgement	This signal turns ON when the overall judgement is NG. Even if the OR output of parallel signals is set for a one-shot output, this signal will not be output at the same time.	Command/ response communications
		This signal turns OFF when overall judgement is OK.	
ERR	Error	This signal turns ON when an error is detected in the Vision Sensor.	Sensor status change output
		This signal is OFF while the Vision Sensor is operating normally.	

Signal	Signal name	Function	Application method
RUN	Run Mode	This signal is ON while the Vision Sensor is in Run Mode.	Sensor status change output
		This signal is OFF while the Vision Sensor is not in Run Mode.	
GATE	Data Output Completed	This signal turns ON when the Vision Sensor finishes outputting data.	Data output after measurements
		If [Output handshake] is set to [Yes], this signal automatically turns OFF when the Data Output Request Bit (DSA) signal from the PLC turns OFF. If [Output handshake] is set to [No], this signal turns OFF after the data output period has elapsed.	
Command code	Command code	This I/O port returns the command code that was executed.	Command/response communications
Response code	Response code	This I/O port contains the response code of the executed command.	
Response data	Response data	This I/O port contains the response data of the executed command.	

Important

If measurements are executed in parallel, the EtherNet/IP BUSY signal will also turn ON.

• Output Area

The output area is assigned immediately after the response area in I/O memory.

	Bits																Contents
	15	14	13	12	11	10	9	8	7	6	5	4	3	2	1	0	
+8	DATA 0																Output data 0 (32 bits)
+9																	
.	.																.
.																	
+22	DATA 7																Output data 7 (32 bits)
+23																	
.	.																.
.																	
+38	DATA 15																Output data 15 (32 bits)
+39																	
.	.																.
.																	
+70	DATA 31																Output data 31 (32 bits)
+71																	
.	.																.
.																	
+134	DATA 63																Output data 63 (32 bits)
+135																	

Signal	Signal name	Function	Application
DATA0-63	Output data 0 to 63	<p>These I/O ports output the output data that is specified for the data output method.</p> <p>The data that can be output is determined by the set value of the Output data size setting as follows:</p> <p>32 bytes: Output data 0 to 7 64 bytes: Output data 0 to 15 128 bytes: Output data 0 to 31 256 bytes: Output data 0 to 63</p>	Command/response communications

Accessing Communications Areas Using Variables with NJ-series Controllers

With an NJ-series Controller, only variables can be used to access from the user program the I/O memory addresses that are assigned to the communications areas.

Use the following settings.

● Using Network Variables for Access

Create user-defined variables that match the structures of the communications areas of the Sensor.

Use the Sysmac Studio to define the variables.

Refer to the *Sysmac Studio Version 1 Operation Manual* (Cat. No. W504) for Sysmac Studio operating procedures.

1 Defining the Data Types of the Variables

Define data types for variables that match the structures of the communications areas.

(1) Defining a Data Type for Signal Access

First, define a BOOL array data type to access the control signals and status signals.

Here, a data type called “U_EIPFlag” is defined.

Name of data type: U_EIPFlag

Type of derivative data type: Union

Name of data type	Data type	
U_EIPFlag	UNION	
F	ARRAY[0..31]OF BOOLSpecifies an array of BOOL data from 0 to 31.
W	DWORD32-bit bit string data

(2) Defining Data Types for Communications Area Access

Data types are defined to access the communications areas, with one data type for the command area and another data type for the response and output areas.

Here, data types called “S_EIPOutput” and “S_EIPInput” are defined.

• Data Type to Access the Command Area

Name of data type: S_EIOutput

Type of derivative data type: Structure

Name of data type	Data type	
S_EIOutput	STRUCT	
ControlFlag	U_EIPFlagThe data type that was defined above (1)
CommandCode	DWORD32-bit bit string data
CommandParam1	UDINT32-bit integer data
CommandParam2	UDINT32-bit integer data
CommandParam3	DINT32-bit integer data

• Assignment Example for Variable Data Type That Matches the Command Area

		Bits															
		15	14	13	12	11	10	9	8	7	6	5	4	3	2	1	0
S_EIP Output	Control Flag	+0	ERCLR	-	-	-	-	-	-	-	-	-	-	-	-	TRIG	EXE
		+1	-	-	-	-	-	-	-	-	-	-	-	-	-	-	DSA
	Command Code	+2	Command code														
		+3															
	Command Param1	+4	Parameter 1														
		+5															
	Command Param2	+6	Parameter 2														
		+7															
	Command Param3	+8	Parameter 3														
		+9															

• Data Type to Access the Response and Output Areas

Name of data type: S_EIPInput

Type of derivative data type: Structure

Name of data type	Data type	
S_EIPInput	STRUCT	
StatusFlag	U_EIPFlagThe data type that was defined above (1)
CommandCodeEcho	DWORD32-bit bit string data
ResponseCode	UDINT32-bit integer data
ResponseData	DINT32-bit integer data
OutputData	ARRAY[0..7]OF DINTSpecifies an array of DINT data from 0 to 7.

- Assignment Example for Variable Data Type That Matches the Response and Output Areas

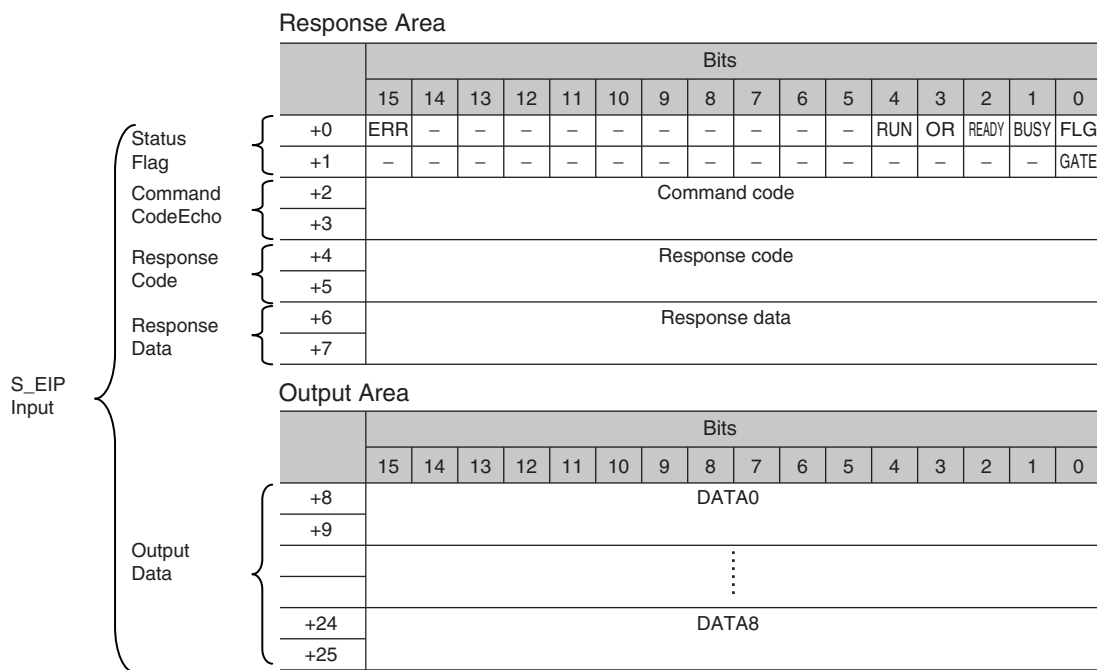

2 Defining the Variables

Define variables for the data links for the communications area data that is used in EtherNet/IP communications.

These variables use the data types that were defined above in procedure 1.

Variable	Variable type	Network Publish attribute	Data type	Application
EIPOutput	Global variable	Output	S_EIPOutput	For data links to the command area
EIPInput	Global variable	Input	S_EIPInput	For data links to the response and output areas

3 Exporting the Variables That Were Defined on Sysmac Studio

Export the variables that you defined so that you can use them on the Network Configurator.

An exported CSV file is created.

4 Network Configurator Settings

- (1) Import to the Network Configurator the CSV file that you exported from the Sysmac Studio. The variables that are imported will automatically be registered as tags.
- (2) Set the connections as shown in the following table.

Originator device (PLC) settings	Target device (Sensor) settings
Input tag set: EIPOutput	Output tag set: Input101
Output tag set: EIPInput	Input tag set: Output100

5 Accessing the Communications Areas from the User Program

The defined variables are used to access the communications areas for the Sensor using the following notation.

- Command Area

Signal name	Variable name
EXE	EIPOutput.ControlFlag.F[0]
TRIG	EIPOutput.ControlFlag.F[1]
ERCLR	EIPOutput.ControlFlag.F[15]
DSA	EIPOutput.ControlFlag.F[16]
Command code	EIPOutput.CommandCode
Command parameter 1	EIPOutput.CommandParam1
Command parameter 2	EIPOutput.CommandParam2
Command parameter 3	EIPOutput.CommandParam3

- Response Area

Signal name	Variable name
FLG	EIPInput.StatusFlag.F[0]
BUSY	EIPInput.StatusFlag.F[1]
READY	EIPInput.StatusFlag.F[2]
OR	EIPInput.StatusFlag.F[3]
RUN	EIPInput.StatusFlag.F[4]
ERR	EIPInput.StatusFlag.F[15]
GATE	EIPInput.StatusFlag.F[16]
Command code	EIPInput.CommandCodeEcho
Response code	EIPInput.ResposeCode
Response data	EIPInput.ResposeData

- Output Area

Signal name	Variable name
Output data 1	EIPInput.OutputData[0]
	⋮
Output data 8	EIPInput.OutputData[7]

- Accessing Communications Areas by Specifying I/O Memory Addresses

AT specifications can be set for variables to individually specify the I/O memory addresses that are assigned in the communications areas.

1 Setting Tag Sets (Network Configurator)

Specify the tag names in the PLC directly by using the I/O memory addresses that are assigned in the communications areas. (Output tags are specified for the input connections to the Sensor and input tags are specified for output connections to the PLC.)

Setting Examples

Output tag: D0

Input tag: D100

2 Setting Variables (Sysmac Studio)

Define variables with AT specifications to the I/O memory addresses that are assigned in the communications areas as shown below.

Setting Examples

Variable: *a* (AT specification: D0.0)

Variable: *b* (AT specification: D0.1)

Variable: *c* (AT specification: D0.15)

Variable: *d* (AT specification: D1.0)

3 Setting Connections

Set the connections as shown in the following table.

Originator device (PLC) settings	Target device (Sensor) settings
Input tag set: D0	Output tag set: Input101
Output tag set: D100	Input tag set: Output100

Example: Setting Example for Variables to Access the Command Area

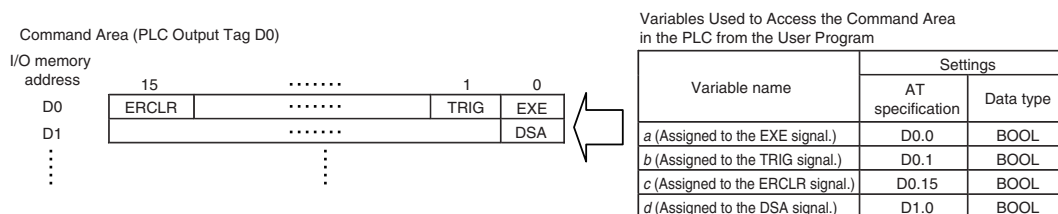

Commands (EtherNet/IP)

This section describes the EtherNet/IP commands.

● Execution Commands

Command code in command area (hex)		Command name	Function	Reference
+2	+3			
1020	0010	Start Continuous Measurements	Starts continuous measurements.	p.207
1030	0010	End Continuous Measurements	Ends continuous measurements.	p.208
2010	0010	Clear Measurement Values	Clears the measurement values.	p.208
2020	0010	Clear Data Output Buffer	Clears all data in the data output buffer of the Sensor.	p.209
2060	0010	Clear Statistical Data	Clears the statistical data (such as the number of measurements, the number of NG overall judgments, the NG rate, and other information since the power supply was turned ON) produced by the logging function held by the Sensor.	p.209
3010	0010	Save Data in Sensor	This command saves the current setting data (system data, scene groups, and calibration data) in the Sensor.	p.210

Command code in command area (hex)		Command name	Function	Reference
+2	+3			
4010	0010	Re-register Model (Search, Shape search II, Sensitive search, Color data)	This command re-registers the models for registered Search, Shape search II, Sensitive search, and Color data inspection items.	p.210
4020	0010	Teaching (All Inspection Items)	Executes teaching for all registered inspection items.	p.211
4021	0010	Teaching (Filter/Position Compensation Item)	Updates reference data for the specified image adjustment processing item (filter item/position compensation item).	p.211
4022	0010	Teaching (Inspection Item)	Updates the reference data for the specified inspection item.	p.212
4031	0010	Re-register Reference Value (Position Compensation Item)	Re-registers the reference value for the specified position compensation item based on the previously loaded image.	p.212
4032	0010	Re-register Reference Value (Inspection Item)	Re-registers the reference values for the specified inspection item based on the previously loaded image.	p.213
8010	0010	Set Registered Image	Sets the latest image or a specified logging image as a registered image.	p.213
8020	0010	Acquire Registered Image	Loads a registered image saved to the SD card or PC Tool as the measurement image.	p.214
9010	0010	Echo	This command returns any data (32 bits or 2 words) sent by the external device as-is.	p.215
F010	0010	Reset Vision Sensor	Restarts the Sensor.	p.215

Important

After you execute the Reset command (0010F010 hex) for the Vision Sensor, turn OFF the EXE signal before the Vision Sensor restarts. If you leave the EXE signal ON, the Vision Sensor will restart repeatedly.

● Commands to Get Status

Command code in command area (hex)		Command name	Function	Reference
+2	+3			
1000	0020	Get Scene Number	Acquires the scene number currently being used.	p.216

● Commands to Set Status

Command code in command area (hex)		Command name	Function	Reference
+2	+3			
1000	0030	Select Scene	Changes the scene number to be used.	p.216

● Commands to Read Data

Command code in command area (hex)		Command name	Function	Reference
+2	+3			
1010	0040	Get Image Adjustment Item Data	Acquires parameters and measurement values for a position compensation item or filter item.	p.217
1020	0040	Get Inspection Item Data	Acquires parameters and measurement values for the specified inspection item.	p.218
1040	0040	Acquire Camera Parameter	Acquires the value of the specified camera parameter.	p.218
3000	0040	Get Software Version Information	Acquires the Sensor's software version.	p.221
4010	0040	Acquire System Data	Acquires the value set for the specified system data.	p.222
4060	0040	Acquire Terminal Offset Data	Acquires the terminal offset data that is added to the IN0 to IN4 command parameters when executing parallel commands.	p.226
6010	0040	Acquire Statistical Data	Acquires the statistical data (such as the number of measurements, number of NG overall judgments, and other information, since the power supply was turned ON) held by the Sensor.	p.227
5000	0020	Get Latest Error Information	Acquires the Sensor's most recent error code.	p.227
7010	0020	Acquire Communication Input Status	Acquires the input status (allowed/prohibited) for the communications protocol set with the Set Communication Input Status command.	p.228
7020	0020	Acquire Communication Output Status	Acquires the output status (allowed/prohibited) for the communications protocol set with the Set Communication Output Status command.	p.229
8010	0020	Acquire Terminal Status	Acquires the ON/OFF status of the input signal for the specified parallel I/O terminal.	p.230
8020	0020	Batch Acquire Terminal Status	Batch acquires the ON/OFF status for the all parallel I/O input terminals other than the IN terminals.	p.231
8030	0020	Batch Acquire IN Terminal Status	Batch acquires the ON/OFF status for the IN terminals.	p.231
F000	0020	Acquire Execution Mode	Acquires the FQ2 execution status (execution mode).	p.232

● Commands to Write Data

Command code in command area (hex)		Command name	Function	Reference
+2	+3			
1010	0050	Set Image Adjustment Item Data	Sets parameters for a position compensation item or filter item.	p.233
1020	0050	Set Inspection Item Data	Sets parameters for the specified inspection item.	p.233
1040	0050	Set Camera Parameter	Sets the value for the specified camera parameter.	p.234
4010	0050	Set System Data	Sets the value to the specified system data.	p.235
4060	0050	Set Terminal Offset Data	Sets the value of the terminal offset data that is added to the IN0 to IN4 command parameters	p.235
7010	0030	Set Communication Input Status	Sets the input status (allowed/prohibited) of the communications port for the specified communications protocol.	p.236
7020	0030	Set Communication Output Status	Sets the output status (allowed/prohibited) of the communications port for the specified communications protocol.	p.237
8010	0030	Set Terminal Status	Sets the output signal ON/OFF status for the specified parallel I/O terminal.	p.238
8020	0030	Batch Set Terminal Status	Batch sets the ON/OFF status for the all parallel I/O output terminals other than the D terminals (D0 to D15).	p.239
8030	0030	Batch Set D Terminal Status	Batch sets the ON/OFF status for the D terminals (D0 to D15).	p.240
F000	0020	Set Execution Mode	Sets the FQ2 execution status (execution mode).	p.241

● Load Setting Data Commands

Command code in command area (hex)		Command name	Function	Reference
+2	+3			
1000	0060	Load Scene Data	Loads scene data that is stored on the SD card inserted in the Touch Finder.	p.242
2000	0060	Load All Scene Data	Loads all scene data that is stored on the SD card inserted in the Touch Finder.	p.243
3000	0060	Load System Data	Loads system data that is stored on the SD card inserted in the Touch Finder.	p.244
5000	0060	Load All Setting Data	Loads all setting data (all scene data, system data, calibration group data) for the Sensor saved as a backup file from the SD card inserted in the Touch Finder.	p.245
A000	0060	Load Calibration Data	Loads calibration data that is stored on the SD card inserted in the Touch Finder as the specified calibration number.	p.246

Command code in command area (hex)		Command name	Function	Reference
+2	+3			
B000	0060	Load All Calibration Data	Loads all calibration data that is stored on the SD card inserted in the Touch Finder.	p.247
C000	0060	Load Model Dictionary Data	Loads model dictionary data that is stored on the SD card inserted in the Touch Finder as the model dictionary with the specified number.	p.248
D000	0060	Load All Model Dictionary Data	Loads all model dictionary data that is stored on the SD card inserted in the Touch Finder.	p.249

● Save Setting Data Commands

Command code in command area (hex)		Command name	Function	Reference
+2	+3			
1000	0070	Save Scene Data	Saves scene data to the SD card inserted in the Touch Finder as a file.	p.250
2000	0070	Save All Scene Data	Saves all scene data as a file to the SD card inserted in the Touch Finder.	p.251
3000	0070	Save System Data	Saves system data as a file to the SD card inserted in the Touch Finder.	p.252
4000	0070	Save Image Data	Saves image data saved in the Sensor's memory by the logging function to the SD card inserted in the Touch Finder as ifz data.	p.253
4010	0070	Save All Image Data	Saves all image data saved in the Sensor's memory by the logging function to the SD card inserted in the Touch Finder as ifz data.	p.254
4020	0070	Save Latest Input Image Data	Saves the latest input image to the SD card inserted in the Touch Finder as ifz data.	p.260
5000	0070	Save All Setting Data	Saves all setting data (all scene data, system data, calibration group data) for the Sensor to the SD card inserted in the Touch Finder as a backup file.	p.255
A000	0070	Save Calibration Data	Saves the data for the specified calibration number as a file to the SD card inserted in the Touch Finder.	p.256
B000	0070	Save All Calibration Data	Saves all calibration data as a file to the SD card inserted in the Touch Finder.	p.257
C000	0070	Save Model Dictionary Data	Saves the specified number of model dictionary data as a file to the SD card inserted in the Touch Finder.	p.258
D000	0070	Save All Model Dictionary Data	Saves all model dictionary data as a file to the SD card inserted in the Touch Finder.	p.259
7000	0070	Save Measurement Data	Saves measurement data saved in the Sensor's memory by the logging function to the SD card inserted in the Touch Finder as csv data.	p.260

Command code in command area (hex)		Command name	Function	Reference
+2	+3			
8000	0070	Save Statistical Data	Saves statistical data saved in the Sensor's memory by the logging function to the SD card inserted in the Touch Finder as csv data.	p.261

Timing Chart for EtherNet/IP Communications

● Performing Measurements with the TRIG Signal

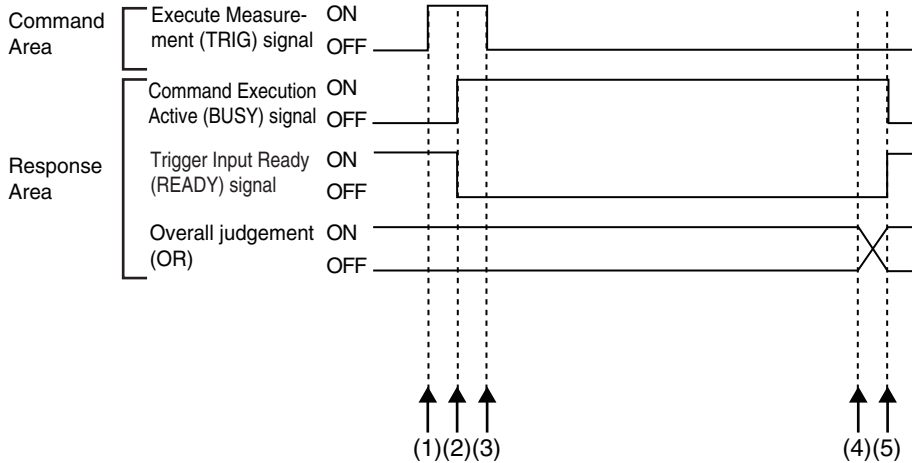

- (1) Measurement starts when the TRIG signal turns ON while the BUSY signal is OFF.
- (2) The BUSY signal turns ON when measurement begins.
- (3) The TRIG signal turns OFF when the BUSY signal turns ON.
- (4) The OR of the measurement results is output when measurements are completed.
- (5) The BUSY signal turns OFF when the BUSY output condition is met.

● Execution of Control Commands Other Than Continuous Measurements with the Control Command Execution Bit (EXE) Signal

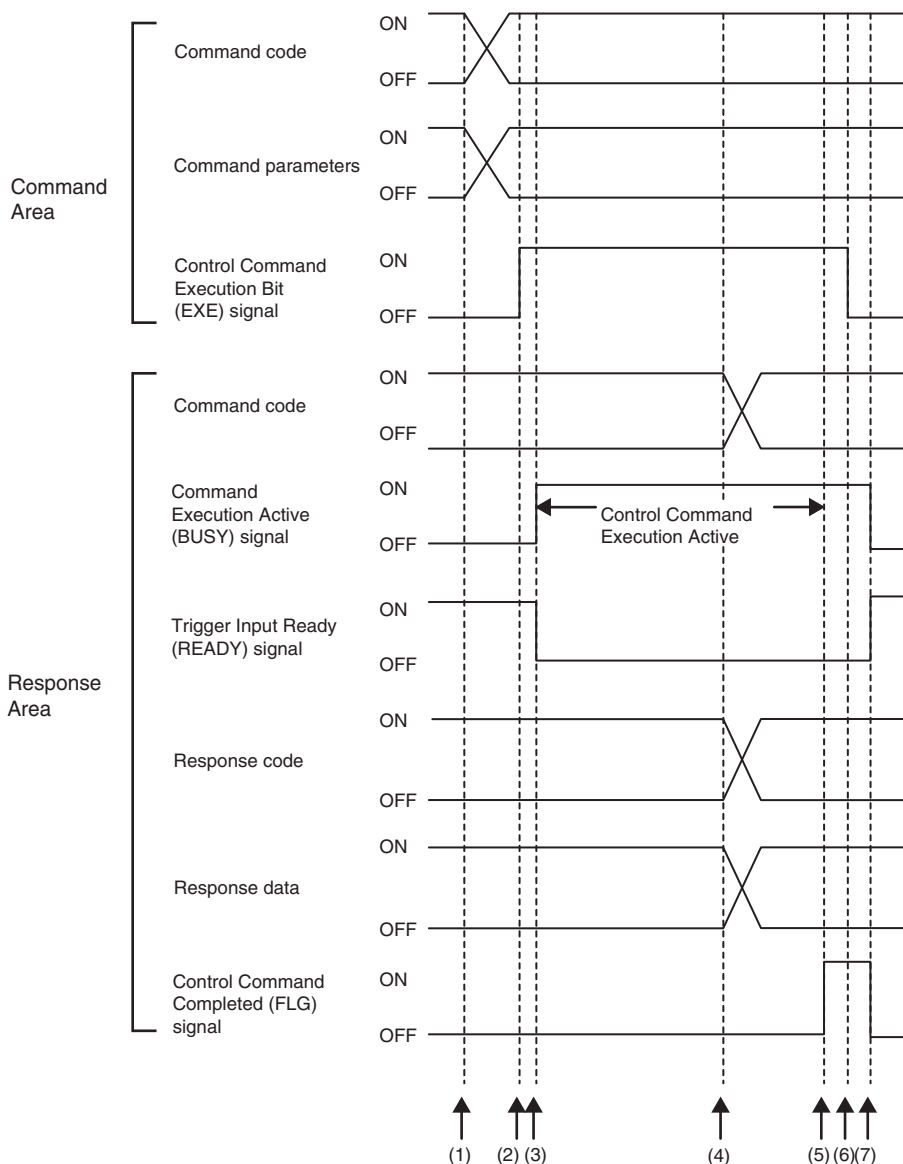

- (1) Set the command code and the command parameters from the PLC while the BUSY signal is OFF.
- (2) The Controller turns ON the Control Command Execution Bit (EXE) signal. The execution command is sent to the Vision Sensor.
- (3) When the Vision Sensor receives the execution command, the Command Execution Active (BUSY) signal turns ON, the Trigger Input Ready (READY) signal turns OFF, and the command is executed.
- (4) The command code, response code, and response data are set when the Vision Sensor completes execution of the command.
- (5) The Control Command Completed (FLG) signal turns ON.
- (6) When the PLC detects that the Control Command Completed (FLG) signal is ON, it turns OFF the Control Command Execution Bit (EXE) signal.
- (7) When the Vision Sensor detects that the Control Command Execution Bit (EXE) signal is OFF, it automatically turns OFF the Control Command Completed (FLG) signal and the Command Execution Active (BUSY) signal, and turns ON the Trigger Input Ready (READY) signal.

● Execution of Control Commands for Continuous Measurements with the Control Command Execution Bit (EXE) Signal

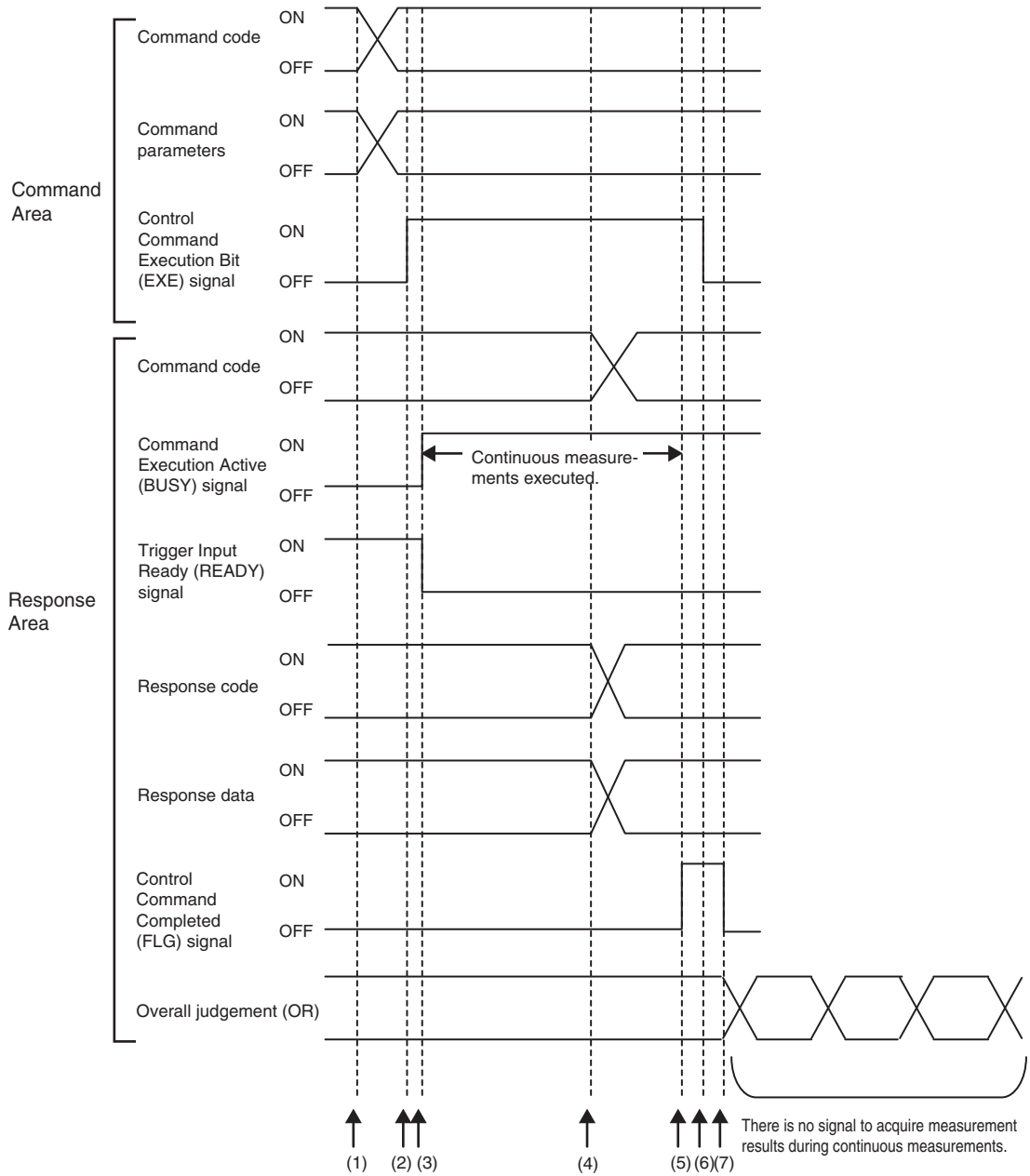

- (1) Set the Start Continuous Measurements command code and the command parameters from the PLC while the BUSY signal is OFF.
- (2) The Controller turns ON the Control Command Execution Bit (EXE) signal. The execution command is sent to the Vision Sensor.
- (3) When the Vision Sensor receives the execution command, the Command Execution Active (BUSY) signal turns ON, the Trigger Input Ready (READY) signal turns OFF, and the command is executed. Continuous measurements start at this time.
- (4) The command code, response code, and response data are set when the Vision Sensor completes execution of the command.
- (5) The Control Command Completed (FLG) signal turns ON.
- (6) When the PLC detects that the Control Command Completed (FLG) signal is ON, it turns OFF the Control Command Execution Bit (EXE) signal.
- (7) When the Vision Sensor detects that the Control Command Execution Bit (EXE) signal is OFF, it automatically turns OFF the Control Command Completed (FLG) signal. The BUSY signal remains ON until continuous measurements are completed.
- (8) During continuous measurements, an OR of the measurement results is output each time a measurement is completed.

Note

During execution of continuous measurements, the BUSY signal remains ON. The Vision Sensor will acknowledge the EXE signal only after the End Continuous Measurements command is executed.

● Data Output after Measurements When Handshaking Is Enabled

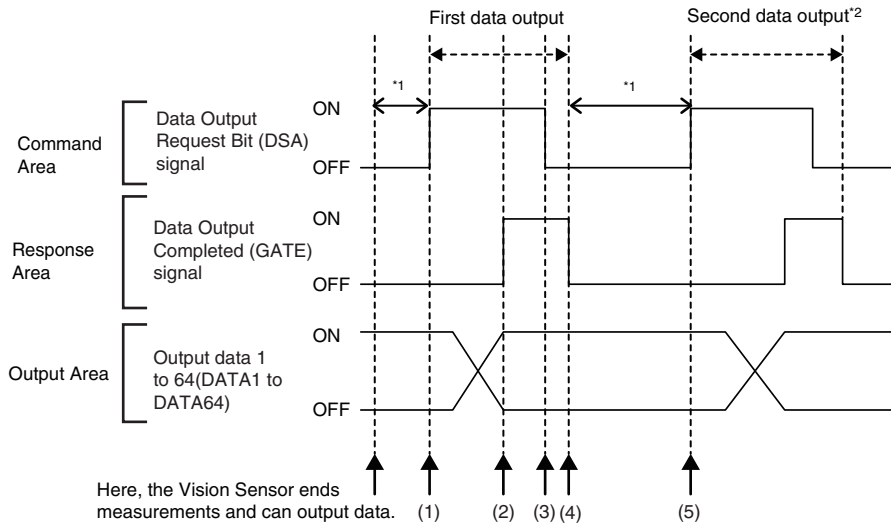

- (1) After measurements are completed, the Data Output Request Bit (DSA) signal is turned ON by the PLC and a request is made to the Vision Sensor to output the data.
- (2) The Vision Sensor outputs the data. After the data is output, the Data Output Completed (GATE) signal turns ON.
- (3) The master confirms that the Data Output Completed (GATE) signal has turned ON, loads the data, and turns OFF the Data Output Request Bit (DSA) signal.
- (4) When the Vision Sensor detects that the Data Output Request (DSA) signal is OFF, it automatically turns OFF the Data Output Completed (GATE) signal.
- (5) The Data Output Request Bit (DSA) signal is turned ON from the PLC and a request is made to output the data.

*1 If the data output request signal is not manipulated within the control timeout time (100 to 120,000 ms) in the EtherNet/IP settings, and data output error will occur and the ERR signal will turn ON. When the ERCLR signal is turned ON, the ERR signal will turn OFF. However, if a timeout occurs again, the ERR signal will turn ON again. Therefore, correctly request data output (DSA control) or execute a Clear Data Output Buffer command.

*2 Indicates that the data to output is separated and output more than once.

● Data Output after Measurements When Handshaking Is Disabled

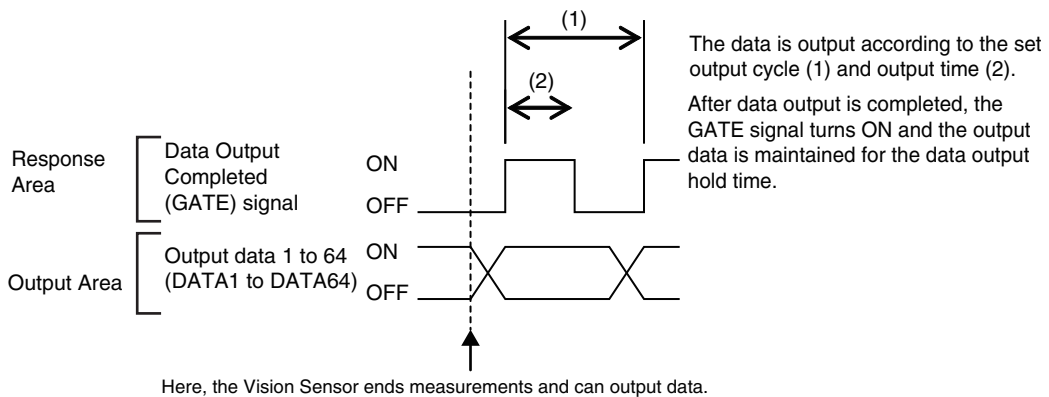

The data is output according to the set output cycle (1) and output time (2). After data output is completed, the GATE signal turns ON and the output data is maintained for the data output hold time.

Important

Set the parameters so that the following conditions are met for the data output period and time.

- Set the timeout time in the connection settings^{*1} between the PLC and Sensor so that it is longer than the measurement processing time of the Sensor.
- Set the data output period so that it is longer than the GATE signal ON period and shorter than the measurement interval of the Sensor.
- Set the GATE signal ON period so that it is longer than the cycle time of the PLC and longer than the packet interval (RPI).
- When operating under high-load conditions, a considerable leeway is required in the measurement interval to enable stable communications.
- On a network to which many devices are connected, performance may drop (e.g., responses may be delayed or packets lost) or communications errors may occur when there is temporarily high traffic on the network. Test the operation under actual conditions before you start actual operation of the system.
- If the measurement interval is short, communications errors may occur depending on the measurement processing time of the Sensor and the settings in the PLC. Set the timeout time in the connection settings^{*1} so that it is longer than the measurement processing time of the Sensor or increase the measurement interval.

*1 These are the connection settings for tag data links. Make these settings from the Network Configurator.

Sample Ladder Programming

● Command/Response Communications

The following sample program is used to clear measurement values.

The Clear Measurement Values command (lower bytes: #2010, upper bytes: #0010) is sent to the Vision Sensor.

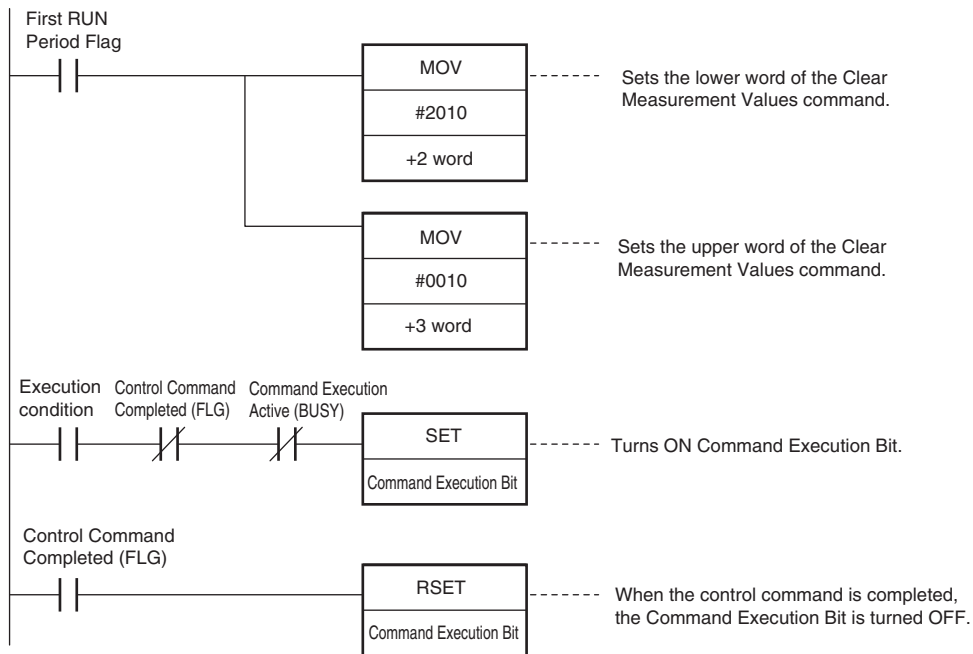

Important

Create the ladder program to control the TRIG signal so that it does not turn ON while the BUSY signal is ON. If not, a TRIG input error will occur and the ERROR signal will turn ON.

Note

While the trigger input (TRIG signal) for parallel measurements is ON, the EtherNet/IP BUSY signal will also be ON. Therefore, no EtherNet/IP commands will be executed. Any EtherNet/IP commands will be executed after execution of the parallel commands. You can also use a EtherNet/IP to perform measurements and output data with the parallel I/O measurement trigger signal (TRIG).

● Data Output after Measurements When Handshaking Is Enabled

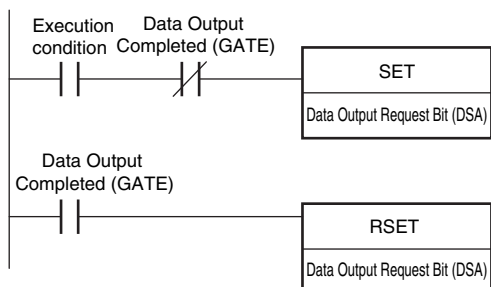

Communicating with the Sensor Controller with EtherNet/IP Message Communications

Message communications are used when communicating with a PLC that does not support tag data link communications or when using functions, such as character string output, that are not supported in tag data link communications.

Message communications can be performed either by exchanging the same data as for tag data link communications using assembly objects or by sending and receiving commands equivalent to non-procedure commands using Sensor Controller-specific Vision Sensor objects.

This document mainly describes the assembly objects and Sensor Controller-specific Vision Sensor objects. For information on the procedures for sending messages, refer to the manuals for the PLC you are using.

For more details about the assembly objects and Vision Sensor objects, refer to  5-2 Detailed EtherNet/IP Communications Specifications on page 433.

Assembly Object

- Communications are performed by sending messages in the Set attribute component to the Sensor and receiving messages in the Get attribute component from the Sensor.
- The formats of the set attribute component and get attribute component are the same as for the output connections and input connections in tag data link communications respectively.

Vision Sensor Object

- Communications are performed by sending messages in the Set attribute component to the Sensor and receiving their responses from the Sensor.
- For the formats, refer to the following command setting example.

Command Setting Example

This section describes how to set attribute command strings and provides a setting example.

- For the data that is sent from the PLC to the Sensor Controller, set a command character string equivalent to a non-procedure command. Attach 0x00 (null) at the end of the character string. No line feed code is required. The size of the send data includes the 0x00 at the end of the character string.
- For the reception data from the Sensor Controller to the PLC, character string data equivalent to the non-procedure command reception character string is returned.

Null (0x00) is inserted in the reception character string delimiter section.

The size of the reception data includes the final 0x00.

Example: Getting the Number (0) of the Current Scene

Send data (2 bytes): 0x53('S') 0x00

↓

Receive data (5 bytes): 0x30('0') 0x00 0x4f('O') 0x4b('K') 0x00

3-2 Controlling Operation and Outputting Data with PLC Link Communications

This section explains how to configure the communication settings that are required for communication between the sensor and external devices by PLC Link. Communication specifications (PLC I/O memory area used for PLC Link communication and types of communication commands) are also described, and a communication timing chart is provided.

Communications Processing Flow

You can use a PLC Link to communicate between the PLC and the Vision Sensor to perform control via command/response communications or to output data after measurements. You can use these communications methods simultaneously.

For PLC Link communications, the following three communications areas are set in the PLC to perform communications.

Command/response communications	1. Command area	This is the area to which you write control commands for the Vision Sensor to execute.
	2. Response area	This is the area to which the Vision Sensor writes the results of control commands executed from the Command Area.
Data output after measurements	3. Output area	This is the area to which the Vision Sensor writes output data for measurements after an inspection is performed.

You can set the area and address settings in the communications specifications of the Vision Sensor to assign the above three communications areas in the I/O memory of the PLC.

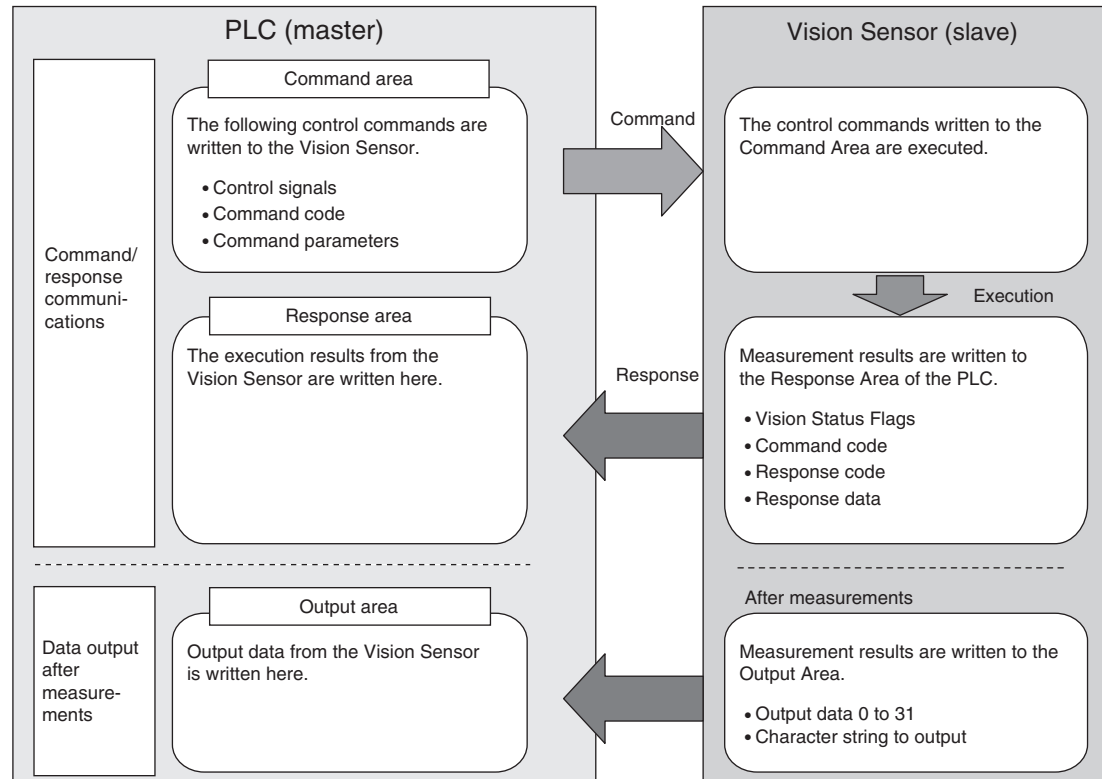

Note

A PLC Link uses three link areas to perform communications: the Command Area, Response Area, and Output Area. A PLC Link is not the same as the Serial PLC Link protocol used to connect PLCs together with serial communications.

Important

- An FQ2 Sensor operates as a TCP server. Therefore, the TCP connection must be made from the PLC. Refer to the manual for the PLC for TCP connection methods.
- The port number on the FQ2 Vision Sensor is always 9877.

Setting Up PLC Link Communications

Setting Network Settings in the Sensor

Set the IP address of the Sensor according to the network where the external devices, such as PLCs, are connected.

▶  (Setup Mode) – [Sensor settings] – [Network] – [Ethernet] – [IP address setting]

- 1 Press [Fixed].
- 2 Set the IP address and subnet mask according to the network where the external devices, such as PLCs, are connected.

Note

If you connect OMRON CS/CJ-series PLCs to the Ethernet, the following default IP addresses are assigned to the PLCs.

- IP address: 192.168.250.*node_address*

Important

- Changes to settings are not applied until the Vision Sensor is restarted. Therefore, save the settings and then restart the Vision Sensor.

 Section 5 Testing and Saving Settings
in Vision Sensor FQ2-S/CH Series User's Manual (Cat. No. Z337)

 Section 7 Convenient Functions
in Vision Sensor FQ2-S/CH Series User's Manual (Cat. No. Z337)

- The port number on the FQ2 Vision Sensor is always 9877.

Initial Settings for PLC Link Communications

You must set the IP address of the PLC to connect to, assign the Command Area, Response Area, and Output Area, and make other settings to perform PLC Link communications.

▶  (Setup Mode) – [Sensor settings] – [Data output] – [Link data output]

- 1 Press [Communication type].
- 2 Press [PLC link (SYSMAC)] or [PLC link (MELSEC)]
depending on the PLC that is connected.

3 Press [Area settings].

Here, you specify the addresses in the I/O memory of the PLC that are to be allocated as the communications areas for PLC Link communications.

Press [Command], [Response], and [Output] and set the memory area ([Area type]) and first word ([Address]) in the I/O memory of the PLC to allocate to each of these communications areas. When you are finished, press [Back].

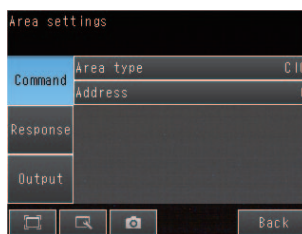

Item	Description		Setting range
Command (command area)	Area type	Select the area for the Command Area in the PLC.	If PLC Link (SYSMAC) is selected: CIO Area (CIO) Work Area (WR) Holding Bit Area (HR) Auxiliary Bit Area (AR) DM Area (DM) EM Area (EM0 to EMC) Default: CIO Area (CIO) If PLC Link (MELSEC) is selected: Data Register (Data registers) File Register (File registers) Link Register (Link registers) Default: Data Register
	Address	Set the first address of the command area in the PLC.	0 to 99,999 Default: 0
Response (response area)	Area type	Set the PLC memory area for the response area.	Same as for the Command Area.
	Address	Set the first address of the response area in the PLC.	0 to 99,999 Default: 100
Output (output area)	Area type	Set the PLC memory area for the output area.	Same as for the Command Area.
	Address	Set the first address of the output area in the PLC.	0 to 99,999 Default: 200

4 Set the communications protocol ([Comm. type]) to PLC Link communications.

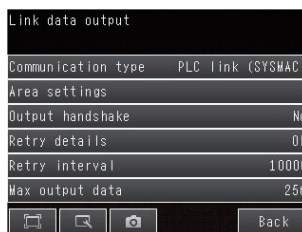



Item	Description	Setting range
Output handshake	Enables or disables handshaking. • Yes: Data is output when the DSA signal from the PLC turns ON. • No: Data is output regardless of the signal state from the PLC.	No or Yes Default: No
Retry details	Enables or disables retrying communications.	ON or OFF Default: ON

Item	Description	Setting range
Retry interval	Sets the interval for retrying communications. This setting is enabled only when [Retry details] is set to [ON].	0 to 2,147,483,647 ms Default: 10,000 ms
Max output data	Sets the maximum data size that can be output at one time through PLC Link communications. Set the number of bytes. Any output data that is beyond this value is discarded.	32 to 1,024 bytes Default: 256 bytes
Data output period	This parameter is displayed and can be set only when [Output handshake] is set to [No]. Set the period for outputting measurement results. Important Set a value that is longer than the GATE ON output time and shorter than the measurement interval of the Sensor.	2 to 5,000 ms (default: 40 ms)
Connection mode	Sets the TCP connection mode.	TCP server or TCP client Default: TCP server
GATE signal ON period	This parameter is displayed and can be set only when [Output handshake] is set to [No]. Set the time to turn ON the GATE signal. Set the time that is required for the PLC to read the measurement results. Important Set a time that is longer than the PLC cycle time.	1 to 1,000 ms (default: 20 ms)

Important

Changes to settings are not applied until the Vision Sensor is restarted. Therefore, save the settings and then restart the Vision Sensor.

-  Section 5 Testing and Saving Settings
in Vision Sensor FQ2-S/CH Series User's Manual (Cat. No. Z337)
-  Section 7 Convenient Functions
in Vision Sensor FQ2-S/CH Series User's Manual (Cat. No. Z337)

Setting the Data to Output Automatically after Measurements

You can set in advance the data to output automatically after measurements. (You can set up to 32 data items.)

Data That Can Be Output

- Data Output

On the FQ2, data that is output after measurement can be assigned to Data 0 to Data 31 in the output data settings.

When an item is assigned to an output data setting, the data is output in units of four bytes per item. The maximum data size that can be output at once is 1,024 bytes.

Note

If multiple inspection results are assigned to one output data setting, that output data setting will be set for more than four bytes of data output. As a result, it is possible that an item that exceeds the data size that can be output at once will be set in the data output setting. In this case, the data that exceeds the data size will be discarded.

 Order of Output of Measurement Data and Characters: p.24

The measurement data from inspection items that can be output and the calculation results from the expression settings can be output. For data that can be output, refer to the *Measurement Data That Can Be Used for External Outputs and Calculations* for each inspection item.

-  Assigning Detection Results to Output Data: p. 125
- Assigning More Than One Detection Result to Output Data: p. 125

• **Outputting Character Strings (Only Supported on the FQ2-S4/CH)**

You can output a character string for each of the inspection items that reads a character string, such as the OCR inspection item. Also, when reading the character string fails, you can output a specific character string that is set in advance.

-  Outputting Read Character Strings: p. 128

Assigning Inspection Results to Output Data

You can individually assign the parameters of the inspection items to output data (data 0 to data 31). The following procedure shows how to assign the measured position X of [0. Search] to data 0 for a binary output.

▶ **[In/Out] – [I/O setting] – [Output data setting] – [Link data output/Fieldbus data output] – [Output data set]**

- 1** Press [0. Data 0].
- 2** Press [Data setting].
- 3** Press [I0. Search].
- 4** Press [Position X X].

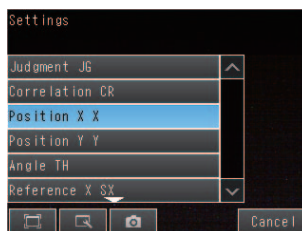

- 5** If the inspection item allows multi-point output, press the number ([0] to [31]) of the inspection result for which to output the data from the list of inspection results.

To register something to data 1 and higher, repeat this process.

The settings will be enabled after you restart the Sensor.

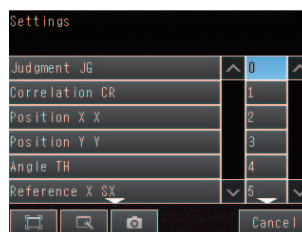

Assigning More Than One Inspection Result to the Same Output Data

You can assign more than one inspection result to the same data output to output all of the assigned results. This is possible for the following inspection results.

- Parameters for the same inspection item: You can assign up to five inspection results.
- Inspection results that support multi-point output: You can assign inspection results within the specified range (0 to 31).

The following procedure shows how to assign more than one inspection result to data 0.

► [In/Out] – [I/O settings] – [Output data setting] – [Link data output/Fieldbus data output] – [Output data set]

- 1 Press [0. Data 0].
- 2 Press [Multi-data].
- 3 Set the following items on the display to set expressions.

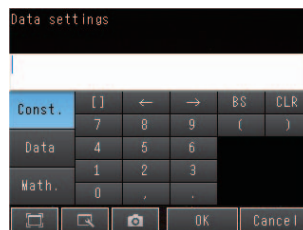

Item	Description
Expression	Register the expression to use to output multiple data. Examples: LPR (0, 3, I0.X, I0.Y) LPC (0, I0.C, I0.X, I0.Y)
Const.	Used to insert numbers and symbols into the expression.
Data	Used to select the inspection items for which to output data and insert the parameters to output into the expression. Example: Selecting Parameters for the Search Item at Inspection Item 0 Inspection item: I0. Search Judgement result: Judgement JG, Correlation: Corre. CR
Math.	Either of the following two functions can be inserted. <ul style="list-style-type: none"> • LPR function (order of the measurement data) The measurement data is output in order. Format: LPR(start_number,number_of_data,data_1, data_2,...data_5) You can omit data 2 to data 5. • LPC function (order of the detection points) Data is output for each detected measurement point. Format: LPC(start_number,number_of_data,data_1, data_2,...data_5) You can omit data 2 to data 5.

**To register something to data 1 and higher, repeat this process.
The settings will be enabled after you restart the Sensor.**

● Expression Setting Example

This example registers an expression to output the following inspection results for data 0.

Inspection item: 0 Search

Parameters to output: Position X, Position Y, Reference SX, and Reference SY

Multi-point output setting: Multi-point output Check Box selected, Count = 4

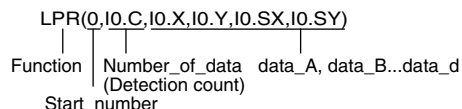

Output Results

The expression that is registered for data 0 assigns the data for 16 items (64 bytes) in the output area as shown below.

Output area data	Assigned data
Output data 0 (4 bytes)	I0.X[0] (Position X 1st point)
Output data 1 (4 bytes)	I0.Y[0] (Position Y 1st point)
Output data 2 (4 bytes)	I0.SX[0] (Reference SX 1st point)
Output data 3 (4 bytes)	I0.SY[0] (Reference SY 1st point)
Output data 4 (4 bytes)	I0.X[1] (Position X 2nd point)
Output data 5 (4 bytes)	I0.Y[1] (Position Y 2nd point)
Output data 6 (4 bytes)	I0.SX[1] (Reference SX 2nd point)
Output data 7 (4 bytes)	I0.SY[1] (Reference SY 2nd point)
Output data 8 (4 bytes)	I0.X[2] (Position X 3rd point)
Output data 9 (4 bytes)	I0.Y[2] (Position Y 3rd point)
Output data 10 (4 bytes)	I0.SX[2] (Reference SX 3rd point)
Output data 11 (4 bytes)	I0.SY[2] (Reference SY 3rd point)
Output data 12 (4 bytes)	I0.X[3] (Position X 4th point)
Output data 13 (4 bytes)	I0.Y[3] (Position Y 4th point)
Output data 14 (4 bytes)	I0.SX[3] (Reference SX 4th point)
Output data 15 (4 bytes)	I0.SY[3] (Reference SY 4th point)

Note

- The inspection results will be output according to the sorting method that is set for multi-point output for the inspection item.
- In order to output multiple detection results of the inspection items that can be output their results simultaneously, from the [Inspection] menu of the targeted inspection item, press [Multi-point output] and select [Yes].

Setting the Output Format

► [In/Out] – [I/O setting] – [Output data setting] – [Link data output/Fieldbus data output]

- 1 Press [Output format].
- 2 Press [Output form].
- 3 Set either a floating point decimal or a fixed decimal for the output form.

Item	Description	Setting range
Output form	Set the output form for numerical data. Fixed decimal point Outputs the data as a x1000 value. Example: 123.456 is output as 0x0001E240 Floating decimal point Outputs the data in floating point decimal format. Example: -123.4567 is output as 0xc2f6e979	Floating point or fixed point (default: fixed point)

Outputting Character Strings (Only Supported on the FQ2-S4/CH)

You can set whether to output the character string that results from reading. Outputting the character string is possible for the following inspection results.

- OCR
- Bar code
- 2D-code
- 2D-code (DPM)

The procedure for outputting the character string is given here for two inspection items.

► [In/Out] – [I/O setting] – [Output data set] – [Link data output/Fieldbus data output] – [Output data set]

- 1 Select the inspection item for which to output the character string.
- 2 Set the following items on the setting display.

Parameter	Setting	Description
String output ON/OFF	OFF (default) Yes	Sets whether to output the character string that results from reading.
Partial output ON/OFF	No (default) Yes	Sets whether to specify the range of characters to output.
Output string setup	1 to 128 for OCR 1 to 1024 for Bar code, 2D-code, or 2D-code (DPM)	Sets the output range.
NG String output on/off	Yes (default) No	Sets whether to output an NG string.

Note

- Endian
Little endian data is output.
- Code Conversion
The converted codes are outputted for the following character codes.

Character code	Before conversion	After conversion
CR	&h0D	&h8541
LF	&h0A	&h8542
DEL	&h7F	&h8543
FF	&hFF	&h8544

Memory Assignments for PLC Link Communications

This section describes the assignments for the Command, Response, and Data Output Areas.

● Command Area

PLC (Master) to Vision Sensor (Slave)

First word	Bits																Contents
	15	14	13	12	11	10	9	8	7	6	5	4	3	2	1	0	
+0	ERRCLR	Resv	Resv	Resv	Resv	Resv	Resv	Resv	Resv	Resv	Resv	Resv	Resv	Resv	Resv	EXE	Control signals (32 bits)
+1	Resv	Resv	Resv	Resv	Resv	Resv	Resv	Resv	Resv	Resv	Resv	Resv	Resv	Resv	Resv	DSA	
+2	Command code															Command code (32 bits)	
+3																	
+4	Parameter 1															Parameter (integer)	
+5																	
+6	Parameter 2															Spare (integer)	
+7																	
+8	Parameter 3															Spare (integer)	
+9																	

Signal	Signal name	Function	Application
EXE	Control Command Execution Bit	Turn ON this signal from the PLC to send a control command for the Vision Sensor to execute.	Command/response communications
		Turn OFF the EXE signal from the PLC when the Control Command Completed (FLG) signal from the Vision Sensor turns ON. (Set the control command code and parameters before you turn ON this signal.)	
DSA	Data Output Request Bit	Turn ON this signal from the PLC to request data output. When this signal turns ON, the Vision Sensor outputs data.	Data output after measurements
		Turn OFF the DSA signal from the PLC when the Data Output Completed (GATE) signal from the Vision Sensor turns ON.	

Signal	Signal name	Function	Application
ERRCLR	Clear Error	Turn ON this signal to turn OFF the error (ERR) signal from the Vision Sensor.	Command/ Response Communications
		Turn OFF this signal from PLC when the error (ERR) signal goes OFF.	
Command code	Command code	This I/O port stores the command code.	Command/ Response Communications
Parameters 1 to 3	Command parameters	These I/O ports store the command parameters.	

● Response Area

Vision Sensor (Slave) to PLC (Master)

First word	Bits																Contents
	15	14	13	12	11	10	9	8	7	6	5	4	3	2	1	0	
+0	ERR	Resv	Resv	Resv	Resv	Resv	Resv	Resv	Resv	Resv	Resv	Resv	Resv	READY	BUSY	FLG	Control signals (32 bits)
+1	Resv	Resv	Resv	Resv	Resv	Resv	Resv	Resv	Resv	Resv	Resv	Resv	Resv	Resv	Resv	GATE	
+2	Command code																Command code (32 bits)
+3																	
+4	Response code																Response code (32 bits)
+5																	
+6	Response data																Response data (32 bits)
+7																	

Signal	Signal name	Function	Application
FLG	Control Command Completed	This signal turns ON when the Vision Sensor completes execution of the control command.	Command/ response communications
		This signal automatically turns OFF when the Control Command Execution Bit (EXE) signal from the PLC turns OFF. This signal turns ON after the control command code, response code, and response data have been stored.	
BUSY	Command Execution Active	This signal is ON while the Vision Sensor is executing a control command.	Command/ response communications
		It is OFF while the Vision Sensor is not executing a control command.	
READY	Trigger Input Ready	This signal turns ON when the Vision Sensor can execute a command.	Command/ response communications
		This signal turns OFF when the Vision Sensor cannot execute a command.	

Signal	Signal name	Function	Application
ERR	Error	This signal turns ON when an error is detected in the Vision Sensor.	Command/ response commu- nications
		<p>Important</p> <p>This flag turns ON when an error occurs in PLC link communications. This signal will remain OFF for any errors other than PLC Link communications errors.</p> <p>This signal turns OFF when the Clear Error (ERRCLR) signal from the PLC turns ON.</p>	
GATE	Data Output Completed	This signal turns ON when the Vision Sensor finishes outputting data.	Data output after measurements
		When [Output handshake] is set to [Yes], this automatically changes from ON to OFF when the data output request signal (DSA signal) from the user (PLC) changes from ON to OFF. When [Output handshake] is set to [No], this is the interval set in [Data output period].	
Command code	Command code	This I/O port returns the command code that was executed.	Command/ response commu- nications
Response code	Response code	This I/O port contains the response code of the executed command.	
Response data	Response data	This I/O port contains the response data of the executed command.	

● Output Area

Vision Sensor (Slave) to PLC (Master)

First word	Bits															Contents
	15	14	13	12	11	10	9	8	7	6	5	4	3	2	1	
+0	DATA 0															Output data 0 (32 bits)
+1																
.	⋮															⋮
.																
+14	DATA 7															Output data 7 (32 bits)
+15																
.	⋮															⋮
.																
+128	DATA 63															Output data 63 (32 bits)
+129																
.	⋮															⋮
.																
+512	DATA 255															Output data 255 (32 bits)
+513																

Signal	Signal name	Function	Application
DATA0-255	Output data 0 to 255	These I/O ports output the output data that is specified for the data output method. The range of the data that can be output is determined by the set value of the [Max output data] (number of output data upper value) parameter setting as follows: Minimum setting (32 bytes): Output data 0 to 7 Default setting (256 bytes): Output data 0 to 63 Maximum setting (1,024 bytes): Output data 0 to 255	Data output after measurements

Note

If the size of data that is output exceeds the set value of the number of output data upper value setting, the remaining data will be discarded.

 Order of Output of Measurement Data and Characters: p. 24

Command Tables for PLC Link Communications

This section describes the commands used in PLC Link communications.

● Execution Commands

First word of command area (hex)		Command name	Function	Reference
+2	+3			
1010	0010	Single Measurement	Executes one measurement.	p.207
1020	0010	Start Continuous Measurements	Starts continuous measurements.	p.207
1030	0010	End Continuous Measurements	Ends continuous measurements.	p.208
2010	0010	Clear Measurement Values	Clears the measurement values.	p.208
2060	0010	Clear Statistical Data	Clears the statistical data (such as the number of measurements, the number of NG overall judgments, the NG rate, and other information since the power supply was turned ON) produced by the logging function held by the Sensor.	p.209
3010	0010	Save Data in Sensor	Saves the current system data and all scene data in the Sensor.	p.210
4010	0010	Re-register Model (Search, Shape search II, Sensitive search, Color data)	Re-registers the reference values for all registered inspection items based on the previously loaded image.	p.210
4020	0010	Teaching (All Inspection Items)	Executes teaching for all registered inspection items.	p.211

First word of command area (hex)		Command name	Function	Reference
+2	+3			
4021	0010	Teaching (Filter/Position Compensation Item)	Updates reference data for the specified image adjustment processing item (filter item/position compensation item).	p.211
4022	0010	Teaching (Inspection Item)	Updates the reference data for the specified inspection item.	p.212
4031	0010	Re-register Reference Value (Position Compensation Item)	Re-registers the reference value for the specified position compensation item based on the previously loaded image.	p.212
4032	0010	Re-register Reference Value (Inspection Item)	Re-registers the reference values for the specified inspection item based on the previously loaded image.	p.213
8010	0010	Set Registered Image	Sets the latest image or a specified logging image as a registered image.	p.213
8020	0010	Acquire Registered Image	Loads a registered image saved to the SD card or PC Tool as the measurement image.	p.214
9010	0010	Echo	This command returns any data (32 bits or 2 words) sent by the external device as-is.	p.215
F010	0010	Reset Vision Sensor	Restarts the Sensor.	p.215

● Commands to Get Status

First word of command area (hex)		Command name	Function	Reference
+2	+3			
1000	0020	Get Scene Number	Acquires the scene number currently being used.	p.216

● Commands to Set Status

First word of command area (hex)		Command name	Function	Reference
+2	+3			
1000	0030	Select Scene	Changes the scene number to be used.	p.216

● Commands to Read Data

First word of command area (hex)		Command name	Function	Reference
+2	+3			
1010	0040	Get Image Adjustment Item Data	Acquires parameters and measurement values for a position compensation item or filter item.	p.217
1020	0040	Get Inspection Item Data	Acquires parameters and measurement values for the specified inspection item.	p.218

First word of command area (hex)		Command name	Function	Reference
+2	+3			
1040	0040	Acquire Camera Parameter	Acquires the value of the specified camera parameter.	p.218
3000	0040	Get Software Version Information	Acquires the Sensor's software version.	p.221
4010	0040	Acquire System Data	Acquires the value set for the specified system data.	p.222
4060	0040	Acquire Terminal Offset Data	Acquires the terminal offset data that is added to the IN0 to IN4 command parameters when executing parallel commands.	p.226
6010	0040	Acquire Statistical Data	Acquires the statistical data (such as the number of measurements, number of NG overall judgments, and other information, since the power supply was turned ON) held by the Sensor.	p.227
5000	0020	Get Latest Error Information	Acquires the Sensor's most recent error code.	p.227
7010	0020	Acquire Communication Input Status	Acquires the input status (allowed/prohibited) for the communications protocol set with the Set Communication Input Status command.	p.228
7020	0020	Acquire Communication Output Status	Acquires the output status (allowed/prohibited) for the communications protocol set with the Set Communication Output Status command.	p.229
8010	0020	Acquire Terminal Status	Acquires the ON/OFF status of the input signal for the specified parallel I/O terminal.	p.230
8020	0020	Batch Acquire Terminal Status	Batch acquires the ON/OFF status for the all parallel I/O input terminals other than the IN terminals.	p.231
8030	0020	Batch Acquire IN Terminal Status	Batch acquires the ON/OFF status for the IN terminals.	p.231
F000	0020	Acquire Execution Mode	Acquires the FQ2 execution status (execution mode).	p.232

● Commands to Write Data

First word of command area (hex)		Command name	Function	Reference
+2	+3			
1010	0050	Set Image Adjustment Item Data	Sets parameters for a position compensation item or filter item.	p.233
1020	0050	Set Inspection Item Data	This command sets the parameters of the specified inspection item data.	p.233
1040	0050	Set Camera Parameter	Sets the value for the specified camera parameter.	p.234
4010	0050	Set System Data	Sets the value to the specified system data.	p.235

First word of command area (hex)		Command name	Function	Reference
+2	+3			
4060	0050	Set Terminal Offset Data	Sets the value of the terminal offset data that is added to the IN0 to IN4 command parameters	p.235
7010	0030	Set Communication Input Status	Sets the input status (allowed/prohibited) of the communications port for the specified communications protocol.	p.236
7020	0030	Set Communication Output Status	Sets the output status (allowed/prohibited) of the communications port for the specified communications protocol.	p.237
8010	0030	Set Terminal Status	Sets the output signal ON/OFF status for the specified parallel I/O terminal.	p.238
8020	0030	Batch Set Terminal Status	Batch sets the ON/OFF status for the all parallel I/O output terminals other than the D terminals (D0 to D15).	p.239
8030	0030	Batch Set D Terminal Status	Batch sets the ON/OFF status for the D terminals (D0 to D15).	p.240
F000	0020	Set Execution Mode	Sets the FQ2 execution status (execution mode).	p.241

● Load Setting Data Commands

First word of command area (hex)		Command name	Function	Reference
+2	+3			
1000	0060	Load Scene Data	Loads scene data that is stored on the SD card inserted in the Touch Finder.	p.242
2000	0060	Load All Scene Data	Loads all scene data that is stored on the SD card inserted in the Touch Finder.	p.243
3000	0060	Load System Data	Loads system data that is stored on the SD card inserted in the Touch Finder.	p.244
5000	0060	Load All Setting Data	Loads all setting data (all scene data, system data, calibration group data) for the Sensor saved as a backup file from the SD card inserted in the Touch Finder.	p.245
A000	0060	Load Calibration Data	Loads calibration data that is stored on the SD card inserted in the Touch Finder as the specified calibration number.	p.246
B000	0060	Load All Calibration Data	Loads all calibration data that is stored on the SD card inserted in the Touch Finder.	p.247
C000	0060	Load Model Dictionary Data	Loads model dictionary data that is stored on the SD card inserted in the Touch Finder as the model dictionary with the specified number.	p.248
D000	0060	Load All Model Dictionary Data	Loads all model dictionary data that is stored on the SD card inserted in the Touch Finder.	p.249

● Save Setting Data Commands

First word of command area (hex)		Command name	Function	Reference
+2	+3			
1000	0070	Save Scene Data	Saves scene data to the SD card inserted in the Touch Finder as a file.	p.250
2000	0070	Save All Scene Data	Saves all scene data as a file to the SD card inserted in the Touch Finder.	p.251
3000	0070	Save System Data	Saves system data as a file to the SD card inserted in the Touch Finder.	p.252
4000	0070	Save Image Data	Saves image data saved in the Sensor's memory by the logging function to the SD card inserted in the Touch Finder as ifz data.	p.253
4010	0070	Save All Image Data	Saves all image data saved in the Sensor's memory by the logging function to the SD card inserted in the Touch Finder as ifz data.	p.254
4020	0070	Save Latest Input Image Data	Saves the latest input image to the SD card inserted in the Touch Finder as ifz data.	p.260
5000	0070	Save All Setting Data	Saves all setting data (all scene data, system data, calibration group data) for the Sensor to the SD card inserted in the Touch Finder as a backup file.	p.255
A000	0070	Save Calibration Data	Saves the data for the specified calibration number as a file to the SD card inserted in the Touch Finder.	p.256
B000	0070	Save All Calibration Data	Saves all calibration data as a file to the SD card inserted in the Touch Finder.	p.257
C000	0070	Save Model Dictionary Data	Saves the specified number of model dictionary data as a file to the SD card inserted in the Touch Finder.	p.258
D000	0070	Save All Model Dictionary Data	Saves all model dictionary data as a file to the SD card inserted in the Touch Finder.	p.259
7000	0070	Save Measurement Data	Saves measurement data saved in the Sensor's memory by the logging function to the SD card inserted in the Touch Finder as csv data.	p.260
8000	0070	Save Statistical Data	Saves statistical data saved in the Sensor's memory by the logging function to the SD card inserted in the Touch Finder as csv data.	p.261

Timing Chart for PLC Link Communications

● Command/Response Communications

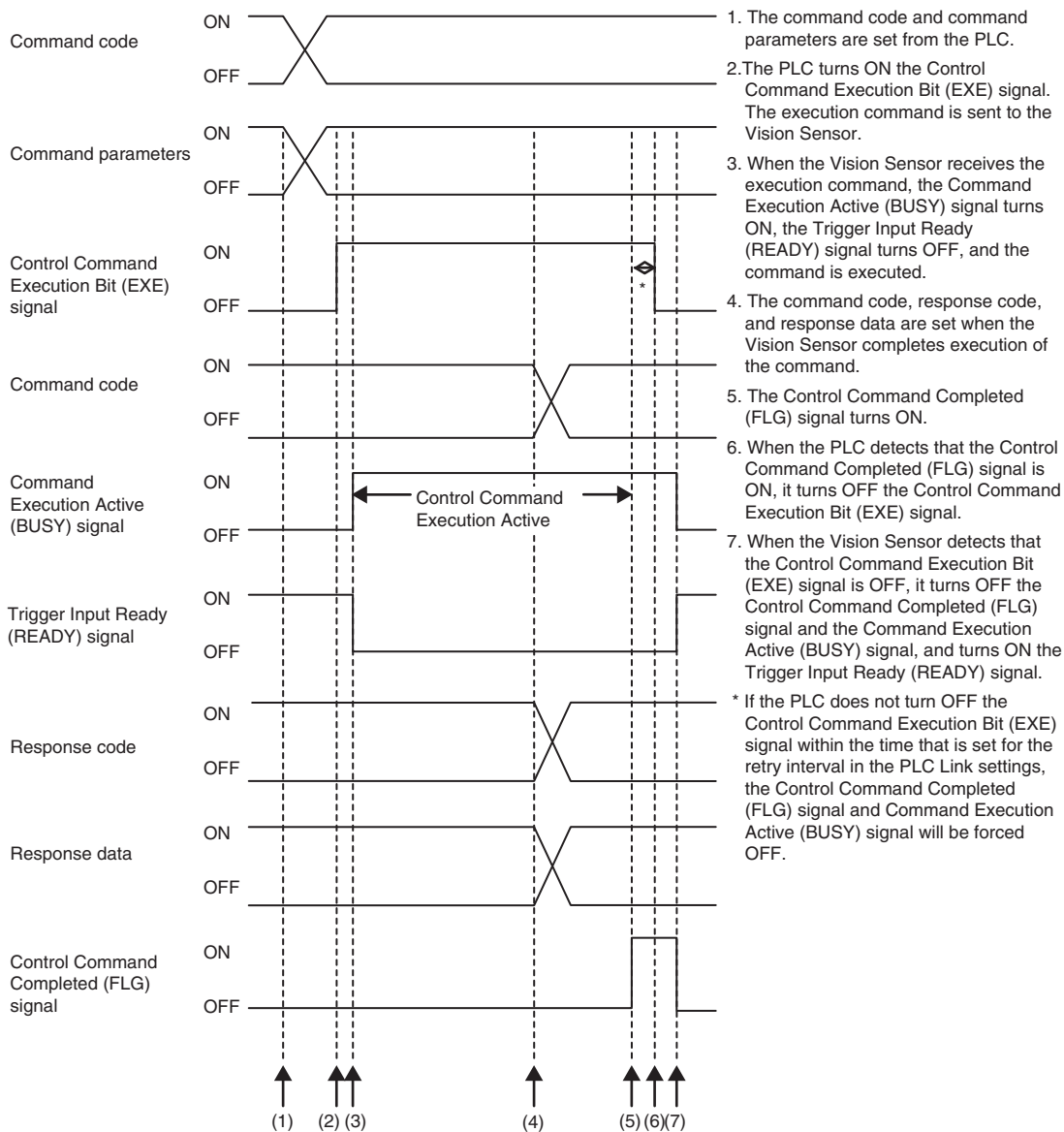

● Data Output after Measurements When Handshaking Is Enabled

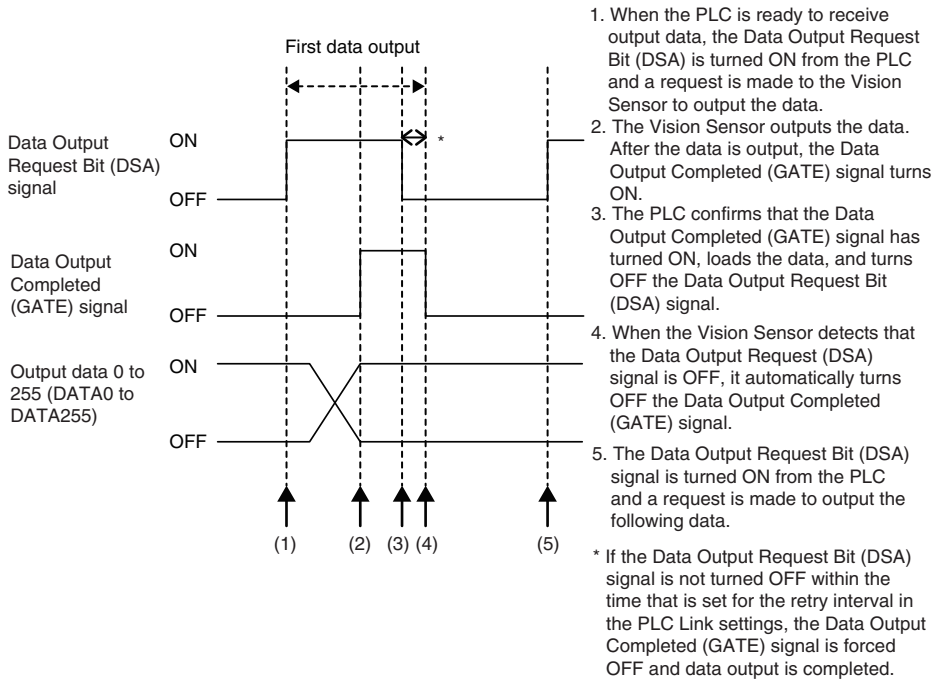

● Data Output after Measurements When Handshaking Is Disabled

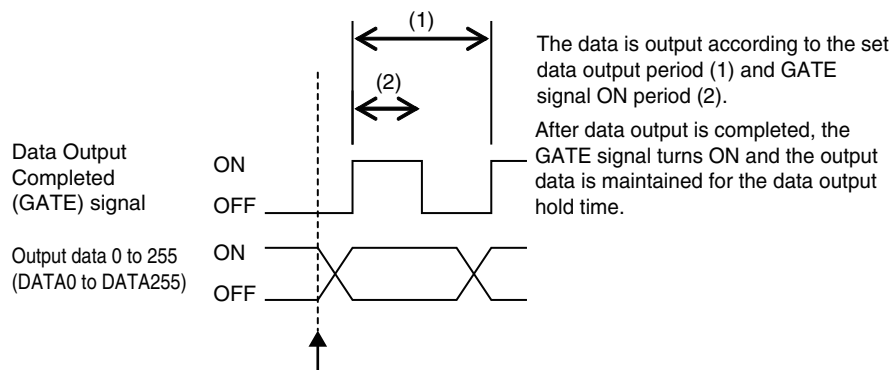

Sample Ladder Programming

● Command/Response Communications

The following sample program is used to perform single measurements. The single measurements command (lower bytes: #1010, upper bytes: #0010) is sent to the Vision Sensor.

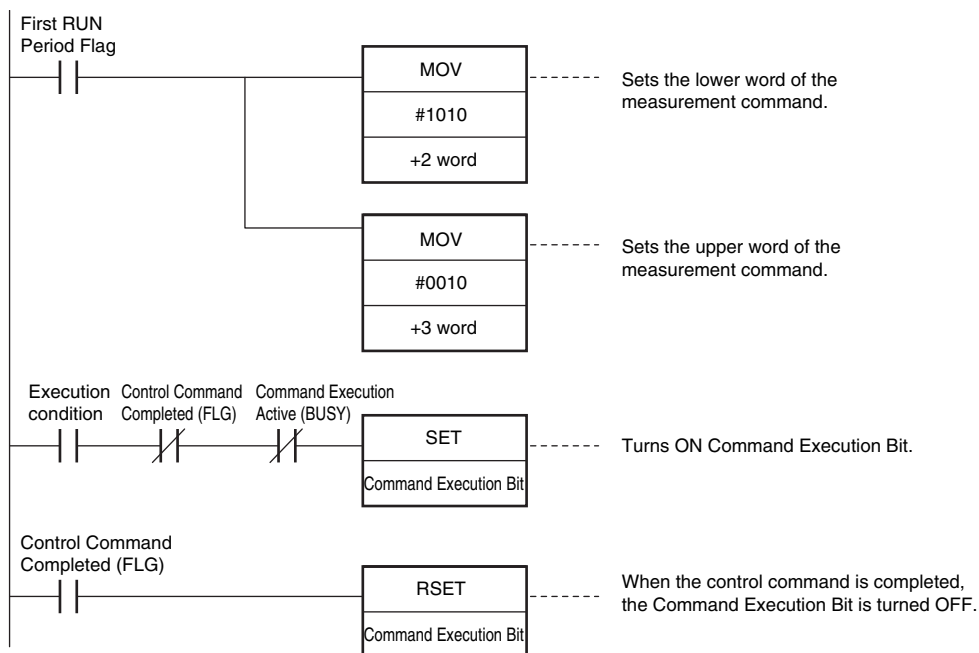

Important

Create the ladder program to control the TRIG signal so that it does not turn ON while the BUSY signal is ON. If not, a TRIG input error will occur and the ERROR signal will turn ON.

Note

You can combine both parallel and PLC Link communications. PLC Link commands cannot be executed while the Command Execution Active (BUSY) parallel communications signal is ON during execution for the parallel measurement trigger input (TRIG signal). Execute PLC Link commands while the Command Execution Active (BUSY) parallel communications signal is OFF. You can also perform measurements with the measurement trigger input (TRIG signal) in parallel I/O and use PLC Link communications to output data.

● Data Output after Measurements When Handshaking Is Enabled

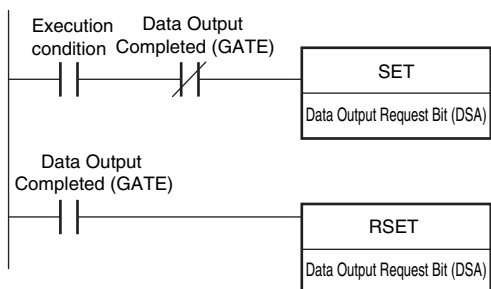

3-3 Outputting Data and Controlling Operation through PROFINET

FQ2-S1 FQ2-S2 FQ2-S3 FQ2-S4 FQ2-CH

Overview of PROFINET

PROFINET is a network for industrial use that applies industrial Ethernet (100 Mbps, Full duplex) to PROFIBUS DP. PROFINET is an open standard that is managed by PI (PROFIBUS and PROFINET International), and is used in a variety of types of industrial equipment. Because PROFINET uses standard Ethernet technology, a variety of general purpose Ethernet devices can be included in the network.

This section provides an overview of PROFINET that is necessary in order to use the FQ2 with PROFINET. For the detailed specifications of PROFINET, refer to literature from IEC61158, IEC61784 and PI.

Types of PROFINET

PROFINET has two types of standards: PROFINET IO and PROFINET CBA.

- PROFINET CBA
Inter-device communication using components. Mainly used between controllers.
- PROFINET IO
Control by I/O data between a controller and devices.

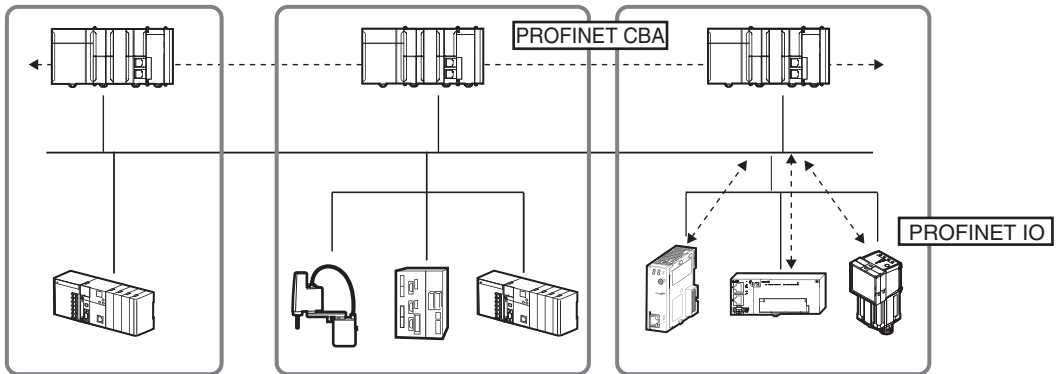

The FQ2 supports PROFINET IO.

PROFINET IO uses the same device model as PROFIBUS DP. The information of each device is described in a GSD (General Station Description) file based on XML (Extensible Markup Language).

Communication Specifications of PROFINET IO

The communication specifications of PROFINET IO are described below.

Communication Specifications	Type	Details	Support on FQ2
Periodic data communication method	RT (real-time) communication	Uses standard Ethernet hardware and achieves the same level of performance as the existing Fieldbus.	Supported
	IRT (Isochronous real-time) communication	This method provides a higher level of assurance than RT that communication will be executed within a specific time. Intended for use in systems such as motion control that require strict real-time.	Not supported

PROFINET IO specifies the supported functions by conformance class, with consideration given to the application.

Class	Overview	Support on FQ2
Class A	Supports the basic functions of RT communication.	Supported
Class B	This class adds network diagnosis and redundancy functions used in process automation and other applications.	Not supported
Class C	Supports IRT communication that realizes reliable synchronization.	Not supported

The functions below are defined in Class A.

Function	Overview
Cyclic data exchange	Real-time data communication between the I/O controller and I/O devices at determined cycles. Set by I/O data CR.
Acyclic parameter data / device identification	Used for parameter settings, I/O device configuration, and reading of device information. Set by record data CR.
Device/network diagnosis	Communication for the purpose of sending alarms and statuses from I/O devices to the I/O controller. Set by Alarm CR.

Device Types Used in PROFINET IO

The devices below are defined in PROFINET IO.

Type	Details
I/O controller	Controller for external and other devices
I/O device	Sensor device connected to the I/O controller The FQ2 is an I/O device.
I/O supervisor	PC or other device used for maintenance and diagnosis

I/O Devices

I/O devices consist of DAPs and I/O modules.

The functions and properties of these devices are described in a GSD file.

- DAP (Device Access Point) : This is an Ethernet access point, and is used by means of a communication program.
- I/O module : Consists of the Slot, Subslot, and Index below. An I/O module has one or multiple slots.
 - Slot : Indicates the location of the I/O module in the I/O device.
 - Subslot : I/O interface inside the slot. This defines data types such as bit data and byte data, and the meanings of the data types.
 - Index : Data in a Subslot.

The above information is described in the GSD file of the FQ2, and the I/O controller uses the GSD file of the FQ2 to build the system.

Note

When an I/O device is used in PROFINET, the GSD file that describes the device functions and properties is used to configure the network configuration settings.

When the FQ2 is used in PROFINET as an I/O device, the GSD file of the FQ2 must be installed in the Engineering Tool.

Data Communication in PROFINET IO

In order for an I/O controller and I/O device to communicate, a connection called an AR (Application Relation) must first be established between the two devices.

When the AR connection is established, data communication between the I/O controller and I/O device takes place by means of a CR (Communication Relation) that defines the content of the data communication.

An I/O device can establish AR relations with multiple communication devices. In addition, multiple CR relations can be defined inside one AR.

By establishing multiple CR relations inside one AR, communication that requires multiple profiles or differing Subslots can be performed.

It is also possible to set a cycle time for each CR or I/O.

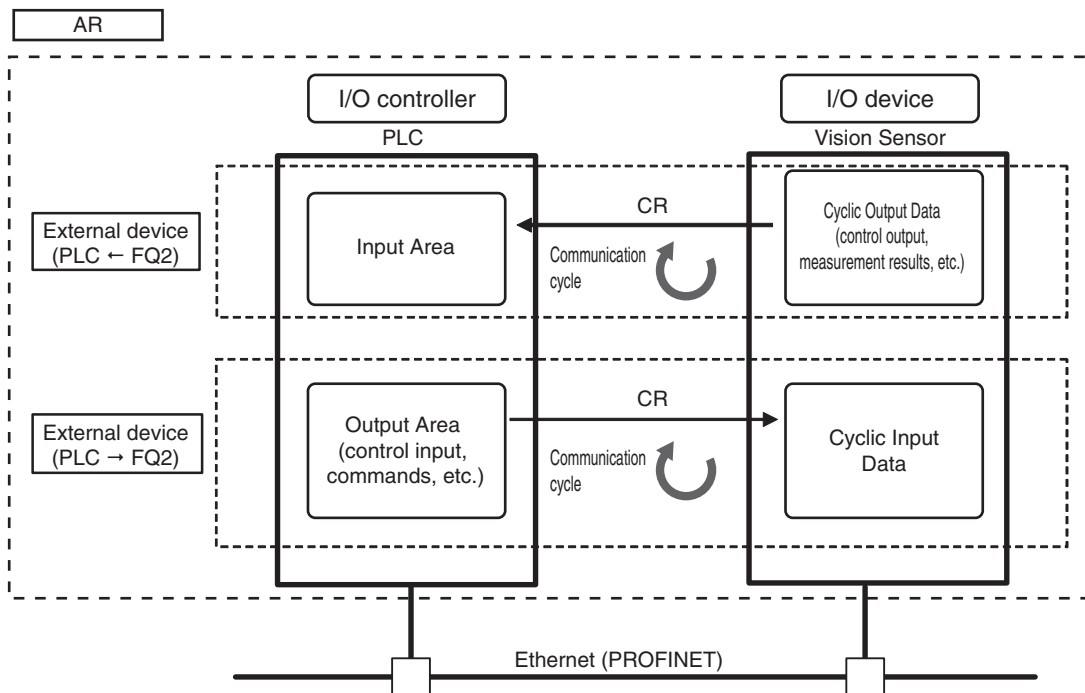

CR is classified into IO data CR, record data CR and alarm CR.

Within the IO data CR, data communication is performed for each refreshing task period. Within the other CR than the IO data CR, communication takes place between the periodic data communication.

Within the record data CR, the IO controller will send commands to the IO device(s) at any time. IO device(s) will send back responses the IO controller.

FQ2 Communications for PROFINET Connections

You can use PROFINET IO data CR to communicate between the PLC and the Vision Sensor to perform control via command/response communications or to output data after measurements. The FQ2 complies with PROFINET conformance class A.

To connect to external devices and communicate using PROFINET, configure the PROFINET IO data CR settings with the Engineering Tool.

For details on the IO data CR settings in the Engineering Tool, refer to the manual for each Engineering Tool.

Types of Communications Areas

For PROFINET communications, the following three communications areas are used in the PLC to perform communications.

Areas Used for the Different Control Methods

Command/response communications	(1) Output Area (command area)	This is the area to which you write control commands for the Vision Sensor to execute.
	(2) Input Area (response area)	This is the area to which the Vision Sensor writes the results of control commands executed from the command area.
Data output after measurements	(3) Input Area (output area)	This is the area to which the Vision Sensor writes output data for measurements after an inspection is performed.

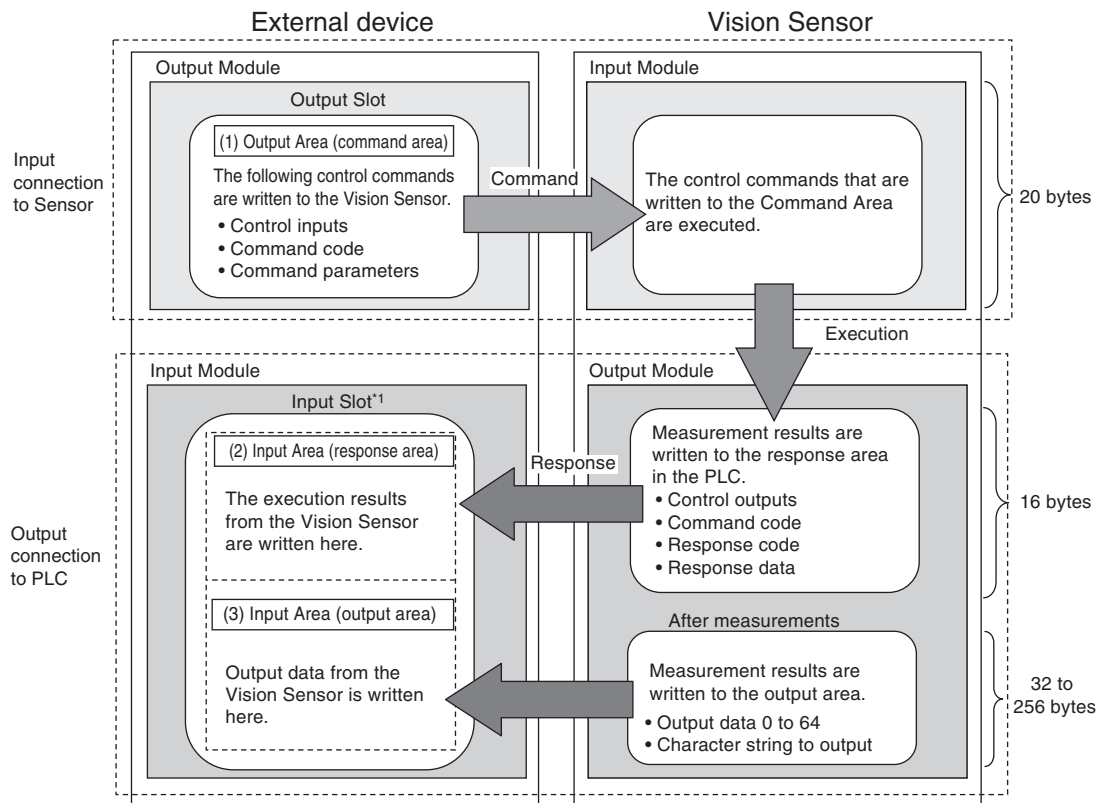

*1: The Input Area (response area) (2) and Input Area (output area) (3) are assigned to continuous memory addresses or to a variable.

Setting Up EtherNet/IP Communications (PROFINET)

Setting Network Settings in the Sensor

Set the IP address of the Sensor according to the network where the external devices, such as PLCs, are connected.

▶  (Setup Mode) – [Sensor settings] – [Network] – [Ethernet] – [IP address setting]

- 1 Press [Fixed].
- 2 Set the IP address and subnet mask according to the network where the external devices are connected.

Important

To use PROFINET communications, do not automatically assign an IP address to the Vision Sensor. Set a specific IP address and do not change it.

Initial Settings for PROFINET Communications

▶  (Setup Mode) – [Sensor settings] – [Data output] – [Fieldbus data output]

- 1 Press [Communication type].
- 2 Press [PROFINET].
- 3 Set the PROFINET communications parameters as described in the following table.

[Output handshake] Set to [Yes]

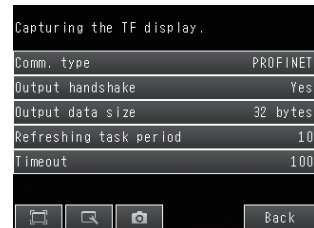

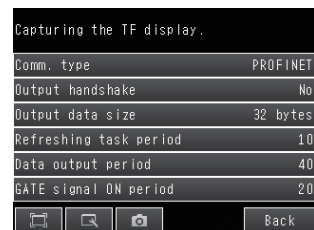

Capturing the TF display .	
Comm. type	PROFINET
Output handshake	Yes
Output data size	32 bytes
Refreshing task period	10
Timeout	100

[Output handshake] Set to [No]



Capturing the TF display .	
Comm. type	PROFINET
Output handshake	No
Output data size	32 bytes
Refreshing task period	10
Data output period	40
GATE signal ON period	20

Parameter	Description	Setting range
Output handshake	<p>Set whether to synchronize with the external device when data is output. No: Measurement results are output without synchronizing with the external device.</p> <p> Data Output after Measurements When Handshaking Is Disabled: p. 117</p> <p>Yes: Measurement results are output while synchronizing with the external device.</p> <p> Data Output after Measurements When Handshaking Is Enabled: p. 117</p>	<ul style="list-style-type: none"> • Yes • No (default: Yes)
Output data size	<p>Set the size of the data that is to be output as the measurement result. Any changes in the setting are applied when the Sensor is restarted.</p> <p>Note</p> <p>If the total size of the data that is specified as output data exceeds the size that is set here, all of the data will not be output at the same time, but will be separated over more than one cycle.</p> <p> Order of Output of Measurement Data and Characters: p. 24</p> <p>Important Set the same value as the parameters set in the external device.</p>	32 bytes, 64 bytes, 128 bytes, or 256 bytes (default: 32 bytes)
Refreshing task period	<p>Set the communications cycle for PROFINET IO communications for the Vision Sensor.</p> <p>Important</p> <ul style="list-style-type: none"> • Set this parameter to the same value as you set for the requested packet interval (RPI) in the external device. • This parameter is necessary for the FQ2 to cycle at the update cycle set in the Engineering Tool. • If the value in the FQ2 is longer than the value in the external device, cyclic data exchange will not be performed according to the expected communications cycle. • The smaller the setting of this parameter is, the more the measurement processing time will be affected. For the lowest setting of 1 ms, the processing time will increase by approximately 5% to 20%. 	1 to 10,000 ms (default: 16 ms)
Timeout	<p>This parameter is displayed and can be set only when [Output handshake] is set to [Yes]. A timeout error will occur if there is no response from the external device within the time that is set.</p> <ul style="list-style-type: none"> • From when measurements are completed until the DSA Bit turns ON • From when the GATE flag turns ON until the DSA Bit turns OFF • From when the GATE flag turns OFF until the DSA Bit turns ON 	0.1 to 120.0 s (default: 10.0 s)

Parameter	Description	Setting range
Data output period	<p>This parameter is displayed and can be set only when [Output handshake] is set to [No]. Set the period for outputting measurement results.</p> <p>Important</p> <p>Set a value that is longer than the GATE ON output time and shorter than the measurement interval of the Sensor.</p>	2 to 5,000 ms (default: 40 ms)
GATE signal ON period	<p>This parameter is displayed and can be set only when [Output handshake] is set to [No]. Set the time to turn ON the GATE signal. Set the time that is required for the external device to read the measurement results.</p> <p>Important</p> <p>Set a value which is equal or longer than the [refreshing task period] (or the requested packet interval).</p>	1 to 1,000 ms (default: 20 ms)

Communication Settings Procedure

To use PROFINET communication, the settings below must be configured.

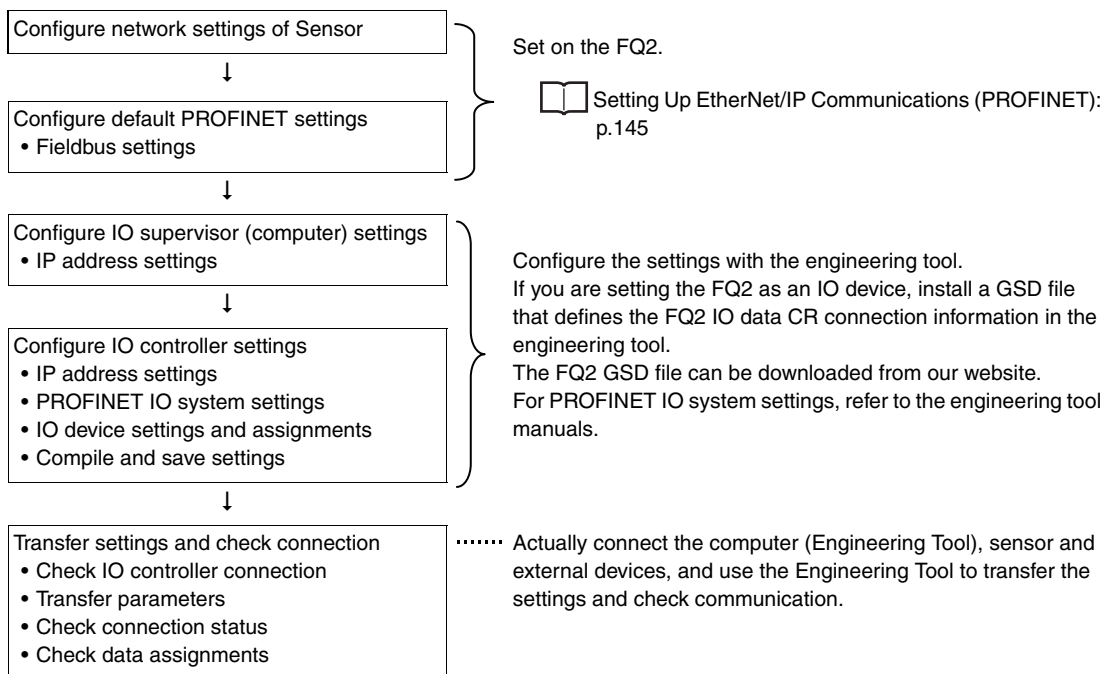

Setting the Data to Output Automatically after Measurements

You can specify the measurement data to output automatically to the PLC after measurements.

Data That Can Be Output

- Data Output

On the FQ2, data that is output after measurement can be assigned to Data 0 to Data 31 in the output data settings.

When an item is assigned to an output data setting, the data is output in units of four bytes per item.

The maximum data size that can be output at once is 256 bytes.

Note

If multiple inspection results are assigned to one output data setting, that output data setting will be set for more than four bytes of data output. As a result, it is possible that an item that exceeds the data size (256 bytes) that can be output at once will be set in the data output setting. In this case, the output will be divided and output over multiple cycles.

 Order of Output of Measurement Data and Characters: p. 24

The measurement data from inspection items that can be output and the calculation results from the expression settings can be output.

For data that can be output, refer to the *Measurement Data That Can Be Used for External Outputs and Calculations* for each inspection item.

 Assigning Inspection Results to Output Data: p. 148
Assigning More Than One Detection Result to Output Data: p. 149

- Outputting Character Strings

You can output a character string for each of the inspection items that reads a character string, such as the OCR inspection item. Also, when reading the character string fails, you can output a specific character string that is set in advance.

 Outputting Read Character Strings: p. 151

Assigning Inspection Results to Output Data (Only supported on the FQ2-S4/CH)

You can individually assign the parameters of the inspection items to output data (data 0 to data 31).

The following procedure shows how to assign the measured position X of [0. Search] to data 0 for a binary output.

▶ [In/Out] – [I/O setting] – [Output data setting] – [Link data output/Fieldbus data output] – [Output data set]

- 1 Press [0. Data 0].
- 2 Press [Data setting].
- 3 Press [I0. Search].

4 Press [Position X X].

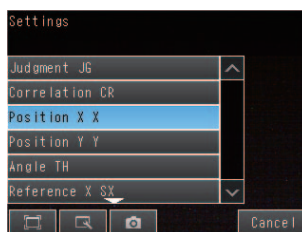

5 If the inspection item allows multi-point output, press the number ([0] to [31]) of the inspection result for which to output the data from the list of inspection results.

To register something to data 1 and higher, repeat this process. The settings will be enabled after you restart the Sensor.

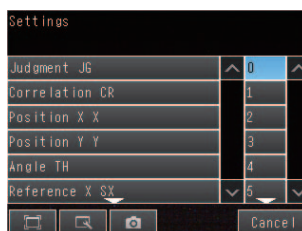

Assigning More Than One Inspection Result to the Same Output Data

You can assign more than one inspection result to the same data output to output all of the assigned results. This is possible for the following inspection results.

- Parameters for the same inspection item: You can assign up to five inspection results.
- Inspection results that support multi-point output: You can assign inspection results within the specified range (0 to 31).

The following procedure shows how to assign more than one inspection result to data 0.

► **[In/Out] – [I/O setting] – [Output data setting] – [Link data output/Fieldbus data output] – [Output data set]**

- 1 Press [0. Data 0].**
- 2 Press [Multi-data setting].**
- 3 Set the following items on the display to set expressions.**

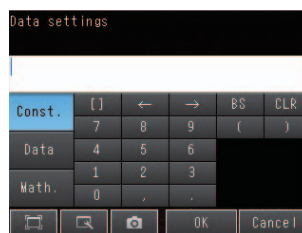

Item	Description
Expression	Register the expression to use to output multiple data. Examples: LPR (0, 3, I0.X, I0.Y) LPC (0, I0.C, I0.X, I0.Y)
Const.	Used to insert numbers and symbols into the expression.
Data	Used to select the inspection items for which to output data and insert the parameters to output into the expression. Example: Selecting Parameters for the Search Item at Inspection Item 0 Inspection item: I0. Search Judgement result: Judgement JG, Correlation: Corre. CR

Item	Description
Math.	<p>Either of the following two functions can be inserted.</p> <ul style="list-style-type: none"> • LPR function (order of the measurement data) The measurement data is output in order. Format: LPR(<i>start_number</i>,<i>number_of_data</i>,<i>data_1</i>, <i>data_2</i>,...<i>data_5</i>) You can omit data 2 to data 5. • LPC function (order of the detection points) Data is output for each detected measurement point. Format: LPC(<i>start_number</i>,<i>number_of_data</i>,<i>data_1</i>, <i>data_2</i>,...<i>data_5</i>) You can omit data 2 to data 5.

To register something to data 1 and higher, repeat this process.
The settings will be enabled after you restart the Sensor.

● Expression Setting Example

This example registers an expression to output the following inspection results for data 0.

Inspection item: 0 Search

Parameters to output: Position X, Position Y, Reference SX, and Reference SY

Multi-point output setting: Multi-point output Check Box selected, Count = 4

LPR(0,I0.C,I0.X,I0.Y,I0.SX,I0.SY)

Function | Number_of_data | data_A, data_B...data_d
(Detection count)

Start_number

Output Results

The expression that is registered for data 0 assigns the data for 16 items (64 bytes) in the Input Area (output area) as shown below.

Output area data	Assigned data
Output data 0 (4 bytes)	I0.X[0] (Position X 1st point)
Output data 1 (4 bytes)	I0.Y[0] (Position Y 1st point)
Output data 2 (4 bytes)	I0.SX[0] (Reference SX 1st point)
Output data 3 (4 bytes)	I0.SY[0] (Reference SY 1st point)
Output data 4 (4 bytes)	I0.X[1] (Position X 2nd point)
Output data 5 (4 bytes)	I0.Y[1] (Position Y 2nd point)
Output data 6 (4 bytes)	I0.SX[1] (Reference SX 2nd point)
Output data 7 (4 bytes)	I0.SY[1] (Reference SY 2nd point)
Output data 8 (4 bytes)	I0.X[2] (Position X 3rd point)
Output data 9 (4 bytes)	I0.Y[2] (Position Y 3rd point)
Output data 10 (4 bytes)	I0.SX[2] (Reference SX 3rd point)
Output data 11 (4 bytes)	I0.SY[2] (Reference SY 3rd point)
Output data 12 (4 bytes)	I0.X[3] (Position X 4th point)
Output data 13 (4 bytes)	I0.Y[3] (Position Y 4th point)
Output data 14 (4 bytes)	I0.SX[3] (Reference SX 4th point)
Output data 15 (4 bytes)	I0.SY[3] (Reference SY 4th point)

Note

- The inspection results will be output according to the sorting method that is set for multi-point output for the inspection item.
- In order to output multiple detection results of the inspection items that can be output their results simultaneously, from the [Inspection] menu of the targeted inspection item, press [Multi-point output] and select [Yes].

Setting the Output Format

► **[In/Out] – [I/O setting] – [Output data setting] – [Link data output/Fieldbus data output]**

- 1 Press [Output format].**
- 2 Press [Output form].**
- 3 Set either a floating point decimal or a fixed decimal for the output form.**

Item	Description	Setting range
Output form	Set the output form for numerical data.	Floating point or fixed point (default: Fixed point)

Outputting Character Strings (Only supported on the FQ2-S4/CH)

You can set whether to output the character string that results from reading. Outputting the character string is possible for the following inspection results.

- OCR
- Bar code
- 2D-code
- 2D-code (DPM)

The procedure for outputting the character string is given here for two inspection items.

► **[In/Out] – [I/O setting] – [Output data setting] – [Link data output/Fieldbus data output] – [Output data set]**

- 1 Select the inspection item for which to output the character string.**
- 2 Set the following items on the setting display.**

Parameter	Setting	Description
String output ON/OFF	OFF (default) Yes	Sets whether to output the character string that results from reading.
Partial output ON/OFF	No (default) Yes	Sets whether to specify the range of characters to output.
Output string setup	1 to 128 for OCR 1 to 1024 for Bar code, 2D-code, or 2D-code (DPM)	Sets the output range.
NG String output on/off	Yes (default) No	Sets whether to output an NG string.

Note

- Endian
Little endian data is output.
- Code Conversion
The converted codes are outputted for the following character codes.

Character code	Before conversion	After conversion
CR	&h0D	&h8541
LF	&h0A	&h8542
DEL	&h7F	&h8543
FF	&hFF	&h8544

Memory Assignments and Commands

Memory Assignments

This section explains the assignments in the Output Area of the CR for input to the sensor (command area), the Input Area of the CR for output to external devices (response area), and the Input Area (output area). Address notation Output Area of the following (command area) is in terms of the representation of the 8-bit units. Also, please note the appendix command for more information, so we are written in 16-bit units.

CR for Input to Sensor (External Devices (IO Controller) to Vision Sensor (IO Device))

- Output Area (Command Area)

Output Area (command area)	Bits								Description
	7	6	5	4	3	2	1	0	
+0	Resv	Resv	Resv	Resv	Resv	Resv	TRIG	EXE	Control flag 1 (8 bits)
+1	ERCLR	Resv	Resv	Resv	Resv	Resv	Resv	Resv	Control flag 2 (8 bits)
+2	Resv	Resv	Resv	Resv	Resv	Resv	Resv	DSA	Control flag 3 (8 bits)
+3	Resv	Resv	Resv	Resv	Resv	Resv	Resv	Resv	Control flag 4 (8 bits)
+4	Command code								Command code (32 bits)
+5									
+6									
+7									
+8	Command parameter 1								Command parameter 1 (32 bits)
+9									
+10									
+11									
+12	Command parameter 2								Command parameter 2 (32 bits)
+13									
+14									
+15									

Output Area (command area)	Bits								Description
	7	6	5	4	3	2	1	0	
+16	Command parameter 3								Command parameter 3 (32 bits)
+17									
+18									
+19									

Signal	Signal name	Function	Application method
EXE	Control Command Execution Bit	Turn ON this signal from the external device to send a control command for the Vision Sensor to execute. Set the control command code and parameters before you turn ON this signal.	Command/ response communications
		Turn OFF the EXE signal from the external device when the Control Command Completed (FLG) signal from the Vision Sensor turns ON.	
TRIG	Execute Measurement	Turn ON this signal from the external device to send a command to execute a measurement.	Command/ response communications
		This signal returns to OFF when the Command Execution Active (BUSY) signal goes ON.	
DSA	Data Output Request Bit * This bit can be used only when hand-shaking is enabled.	Turn ON this signal from the external device to request data output. When this signal turns ON, the Vision Sensor outputs data.	Data output after measurements
		Turn OFF the DSA signal from the external device when the Data Output Completed (GATE) signal from the Vision Sensor turns ON.	
ERCLR	Clear Error	Turn ON this signal to turn OFF the error (ERR) signal from the Vision Sensor.	Command/ response communications
		Turn OFF this signal from the external device when the error (ERR) signal goes OFF.	
Command code	Command code	This I/O port stores the command code.	Command/ response communications
Parameters 1 to 3	Command parameters	These I/O ports store the command parameters.	

CR for Output to External Devices (Vision Sensor (I/O Controller) to External Device (I/O Device))

- Input Area (Response Area)

Input Area (response area)	Bits								Description
	7	6	5	4	3	2	1	0	
+0	Resv	Resv	Resv	RUN	OR	READY	BUSY	FLG	Status flag 1 (8 bits)
+1	ERR	Resv	Resv	Resv	Resv	Resv	Resv	Resv	Status flag 2 (8 bits)
+2	Resv	Resv	Resv	Resv	Resv	Resv	Resv	GATE	Status flag 3 (8 bits)
+3	Resv	Resv	Resv	Resv	Resv	Resv	Resv	Resv	Status flag 4 (8 bits)
+4	Command code								Command code (32 bits)
+5									
+6									
+7									

Input Area (response area)	Bits								Description
	7	6	5	4	3	2	1	0	
+8	Response code								Response code (32 bits)
+9									
+10									
+11									
+12	Response data								Response data (32 bits)
+13									
+14									
+15									

Signal	Signal name	Function	Application method
FLG	Control Command Completed	This signal turns ON when the Vision Sensor completes execution of the control command. (This signal turns ON after the control command code, response code, and response data have been stored.)	Command/ response communications
		This signal automatically turns OFF when the Control Command Execution Bit (EXE) is turned OFF by the user (external device).	
BUSY	Command Execution Active	This signal is ON while the Vision Sensor cannot execute a control command.	Command/ response communications
		This signal is OFF while the Vision Sensor can execute a control command.	
READY	Trigger Input Ready	This signal turns OFF when the Vision Sensor cannot execute a control command.	Command/ response communications
		This signal turns ON when the Vision Sensor can execute a control command.	
OR	Overall judgement	This signal turns ON when the overall judgement is NG. Even if parallel signal OR output is set to "One-shot Output", this signal does not support One-shot Output.	Command/ response communications
		This signal turns OFF when overall judgement is OK.	
ERR	Error	This signal turns ON when an error is detected in the Vision Sensor.	Sensor status change output
		This signal turns OFF when the user (PLC) performs re-measurement or error clear takes place (Error Clear Signal: ON) after an error is cleared.	
RUN	Run Mode	This signal is ON while the Vision Sensor is in Run Mode.	Sensor status change output
		This signal is OFF while the Vision Sensor is not in Run Mode.	
GATE	Data Output Completed	This signal turns ON when the Vision Sensor finishes outputting data.	Data output after measurements
		If [Output handshake] is set to [Yes], this signal automatically turns OFF when the Data Output Request Bit (DSA) signal from the external device turns OFF. If [Output handshake] is set to [No], this signal turns OFF after the data output period has elapsed.	

Signal	Signal name	Function	Application method
Command code	Command code	This I/O port returns the command code that was executed.	Command/ response communications
Response code	Response code	This I/O port contains the response code of the executed command.	
Response data	Response data	This I/O port contains the response data of the executed command.	

Important

If measurements are executed in parallel, the PROFINET BUSY signal will also turn ON.

• Input Area (Output Area)

The Input Area (output area) is assigned immediately after the Input Area (response area) in I/O memory.

Input Area (Output Area)	Bits								Description
	7	6	5	4	3	2	1	0	
+16	Output data 1								Output data 0 (32 bits)
+17									
+18									
+19									
·	·								·
·	·								·
·	·								·
+44	Output data 8								Output data 7 (32 bits)
+45									
+46									
+47									
·	·								·
·	·								·
·	·								·
+76	Output data 16								Output data 15 (32 bits)
+77									
+78									
+79									
·	·								·
·	·								·
·	·								·
+140	Output data 32								Output data 31 (32 bits)
+141									
+142									
+143									
·	·								·
·	·								·
·	·								·

Input Area (Output Area)	Bits								Description
	7	6	5	4	3	2	1	0	
+268	Output data 64								Output data 63 (32 bits)
+269									
+270									
+271									

Signal	Signal name	Function	Application
DATA0-63	Output data 0 to 63	These I/O ports output the output data that is specified for the data output method. The data that can be output is determined by the set value of the Output data size setting as follows: 32 bytes: Output data 0 to 7 64 bytes: Output data 0 to 15 128 bytes: Output data 0 to 31 256 bytes: Output data 0 to 63	Command/ response commu- nications

Commands (PROFINET)

This section describes the PROFINET commands.

The command codes of the commands are assigned to external device memory in the order below.

Example: Start continuous measurements command "00101020"

Output Area (command area)	Command code (HEX)	Bits							
		7	6	5	4	3	2	1	0
+4	20	0	0	1	0	0	0	0	0
+5	10	0	0	0	1	0	0	0	0
+6	10	0	0	0	1	0	0	0	0
+7	00	0	0	0	0	0	0	0	0

● Execution Commands

Command code in command area (hex)	Command name	Function	Reference
00101020	Start Continuous Measure- ments	Starts continuous measurements.	p.207
00101030	End Continuous Measure- ments	Ends continuous measurements.	p.208
00102010	Clear Measurement Values	Clears the measurement values.	p.208
00102020	Clear Data Output Buffer	Clears all data in the data output buffer of the Sensor.	p.209
00102060	Clear Statistical Data	Clears the statistical data (such as the num- ber of measurements, the number of NG overall judgments, the NG rate, and other information since the power supply was turned ON) produced by the logging function held by the Sensor.	p.209

Command code in command area (hex)	Command name	Function	Reference
00103010	Save Data in Sensor	This command saves the current setting data (system data, scene groups, and calibration data) in the Sensor.	p.210
00104010	Re-register Model (Search, Shape search II, Sensitive search, Color data)	This command re-registers the models for registered Search, Shape search II, Sensitive search, and Color data inspection items.	p.210
00104020	Teaching (All Inspection Items)	Executes teaching for all registered inspection items.	p.211
00104021	Teaching (Filter/Position Compensation Item)	Updates reference data for the specified image adjustment processing item (filter item/position compensation item).	p.211
00104022	Teaching (Inspection Item)	Updates the reference data for the specified inspection item.	p.212
00104031	Re-register Reference Value (Position Compensation Item)	Re-registers the reference value for the specified position compensation item based on the previously loaded image.	p.212
00104032	Re-register Reference Value (Inspection Item)	Re-registers the reference values for the specified inspection item based on the previously loaded image.	p.213
00108010	Set Registered Image	Sets the latest image or a specified logging image as a registered image.	p.213
00108020	Acquire Registered Image	Loads a registered image saved to the SD card or PC Tool as the measurement image.	p.214
00109010	Echo	This command returns any data (32 bits or 2 words) sent by the external device as-is.	p.215
0010F010	Reset Vision Sensor	Restarts the Sensor.	p.215

Important

After you execute the Reset command (0010F010 hex) for the Vision Sensor, turn OFF the EXE signal before the Vision Sensor restarts. If you leave the EXE signal ON, the Vision Sensor will restart repeatedly.

● Commands to Get Status

Command code in command area (hex)	Command name	Function	Reference
00201000	Get Scene Number	Acquires the scene number currently being used.	p.216

● Commands to Set Status

Command code in command area (hex)	Command name	Function	Reference
00301000	Select Scene	Changes the scene number to be used.	p.216

● Commands to Read Data

Command code in command area (hex)	Command name	Function	Reference
00401010	Get Image Adjustment Item Data	acquires parameters and measurement values for a position compensation item or filter item.	p.217
00401020	Get Inspection Item Data	Acquires parameters and measurement values for the specified inspection item.	p.218
00401040	Acquire Camera Parameter	Acquires the value of the specified camera parameter.	p.218
00403000	Get Software Version Information	Acquires the Sensor's software version.	p.221
00404010	Acquire System Data	Acquires the value set for the specified system data.	p.222
00404060	Acquire Terminal Offset Data	Acquires the terminal offset data that is added to the IN0 to IN4 command parameters when executing parallel commands.	p.226
00406010	Acquire Statistical Data	Acquires the statistical data (such as the number of measurements, number of NG overall judgments, and other information, since the power supply was turned ON) held by the Sensor.	p.227
00205000	Get Latest Error Information	Acquires the latest error information from the Sensor.	p.227
00207010	Acquire Communication Input Status	Acquires the input status (allowed/prohibited) for the communications protocol set with the Set Communication Input Status command.	p.228
00207020	Acquire Communication Output Status	Acquires the output status (allowed/prohibited) for the communications protocol set with the Set Communication Output Status command.	p.229
00208010	Acquire Terminal Status	Acquires the ON/OFF status of the input signal for the specified parallel I/O terminal.	p.230
00208020	Batch Acquire Terminal Status	Batch acquires the ON/OFF status for the all parallel I/O input terminals other than the IN terminals.	p.231
00208030	Batch Acquire IN Terminal Status	Batch acquires the ON/OFF status for the IN terminals.	p.231
0020F000	Acquire Execution Mode	Acquires the FQ2 execution status (execution mode).	p.232

● Commands to Write Data

Command code in command area (hex)	Command name	Function	Reference
00501010	Set Image Adjustment Item Data	Sets parameters for a position compensation item or filter item.	p.233
00501020	Set Inspection Item Data	Sets parameters for the specified inspection item.	p.233
00501040	Set Camera Parameter	Sets the value for the specified camera parameter.	p.234
00504010	Set System Data	Sets the value to the specified system data.	p.235
00504060	Terminal Offset Data	This command sets the value of the terminal offset data that is added to the IN0 to IN4 command parameters	p.235
00307010	Set Communication Input Status	This command sets the input status (allowed/prohibited) of the communications port for the specified communications protocol.	p.236
00307020	Set Communication Output Status	This command sets the output status (allowed/prohibited) of the communications port for the specified communications protocol.	p.237
00308010	Set Terminal Status	This command sets the output signal ON/OFF status for the specified parallel I/O terminal.	p.238
00308020	Batch Set Terminal Status	Batch sets the ON/OFF status for the all parallel I/O output terminals other than the D terminals (D0 to D15).	p.239
00308030	Batch Set D Terminal Status	Batch sets the ON/OFF status for the D terminals (D0 to D15).	p.240
0020F000	Set Execution Mode	Sets the FQ2 execution status (execution mode).	p.241

● Load Setting Data Commands

Command code in command area (hex)	Command name	Function	Reference
00601000	Load Scene Data	Loads scene data that is stored on the SD card inserted in the Touch Finder.	p.242
00602000	Load All Scene Data	Loads all scene data that is stored on the SD card inserted in the Touch Finder.	p.243
00603000	Load System Data	This command loads system data that is stored on the SD card inserted in the Touch Finder.	p.244
00605000	Load All Setting Data	This command loads all setting data (all scene data, system data, calibration group data) for the Sensor saved as a backup file from the SD card inserted in the Touch Finder.	p.245
0060A000	Load Calibration Data	This command loads calibration data that is stored on the SD card inserted in the Touch Finder as the specified calibration number.	p.246

Command code in command area (hex)	Command name	Function	Reference
0060B000	Load All Calibration Data	This command loads all calibration data that is stored on the SD card inserted in the Touch Finder.	p.247
0060C000	Load Model Dictionary Data	This command loads model dictionary data that is stored on the SD card inserted in the Touch Finder as the model dictionary with the specified number.	p.248
0060D000	Load All Model Dictionary Data	This command loads all model dictionary data that is stored on the SD card inserted in the Touch Finder.	p.249

● Save Setting Data Commands

Command code in command area (hex)	Command name	Function	Reference
00701000	Save Scene Data	This command saves scene data to the SD card inserted in the Touch Finder as a file.	p.250
00702000	Save All Scene Data	This command saves all scene data as a file to the SD card inserted in the Touch Finder.	p.251
00703000	Save System Data	Saves system data as a file to the SD card inserted in the Touch Finder.	p.252
00704000	Save Image Data	Saves image data saved in the Sensor's memory by the logging function to the SD card inserted in the Touch Finder as ifz data.	p.253
00704010	Save All Image Data	This command saves all image data saved in the Sensor's memory by the logging function to the SD card inserted in the Touch Finder as ifz data.	p.254
00704020	Save Latest Input Image Data	Saves the latest input image to the SD card inserted in the Touch Finder as ifz data.	p.260
00705000	Save All Setting Data	This command saves all setting data (all scene data, system data, calibration group data) for the Sensor to the SD card inserted in the Touch Finder as a backup file.	p.255
0070A000	Save Calibration Data	Saves the data for the specified calibration number as a file to the SD card inserted in the Touch Finder.	p.256
0070B000	Save All Calibration Data	Saves all calibration data as a file to the SD card inserted in the Touch Finder.	p.257
0070C000	Save Model Dictionary Data	Saves the specified number of model dictionary data as a file to the SD card inserted in the Touch Finder.	p.258
0070D000	Save All Model Dictionary Data	Saves all model dictionary data as a file to the SD card inserted in the Touch Finder.	p.259
00707000	Save Measurement Data	Saves measurement data saved in the Sensor's memory by the logging function to the SD card inserted in the Touch Finder as csv data.	p.260

Command code in command area (hex)	Command name	Function	Reference
00708000	Save Statistical Data	Saves statistical data saved in the Sensor's memory by the logging function to the SD card inserted in the Touch Finder as csv data.	p.261

Timing Chart for EtherNet/IP Communications

● Performing Measurements with the TRIG Signal

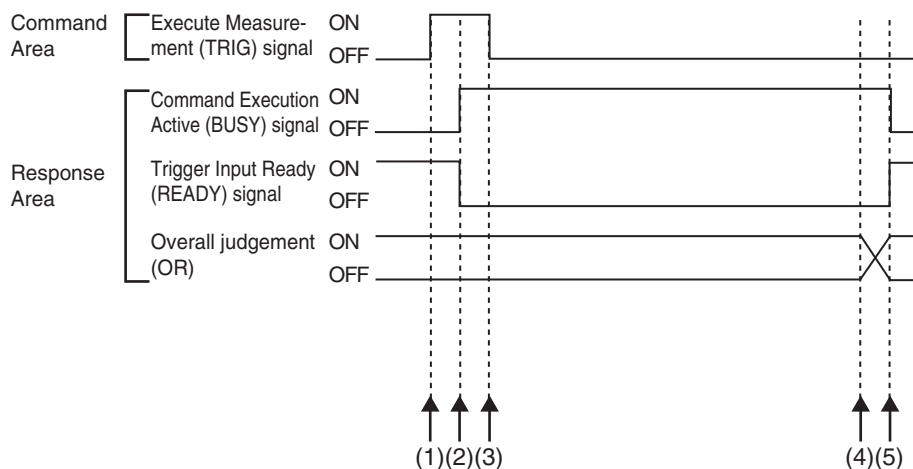

- (1) Measurement starts when the TRIG signal turns ON while the BUSY signal is OFF.
- (2) The BUSY signal turns ON when measurement begins.
- (3) The TRIG signal turns OFF when the BUSY signal turns ON.
- (4) The OR of the measurement results is output when measurements are completed.
- (5) The BUSY signal turns OFF when the BUSY output condition is met.

● Execution of Control Commands Other Than Continuous Measurements with the Control Command Execution Bit (EXE) Signal

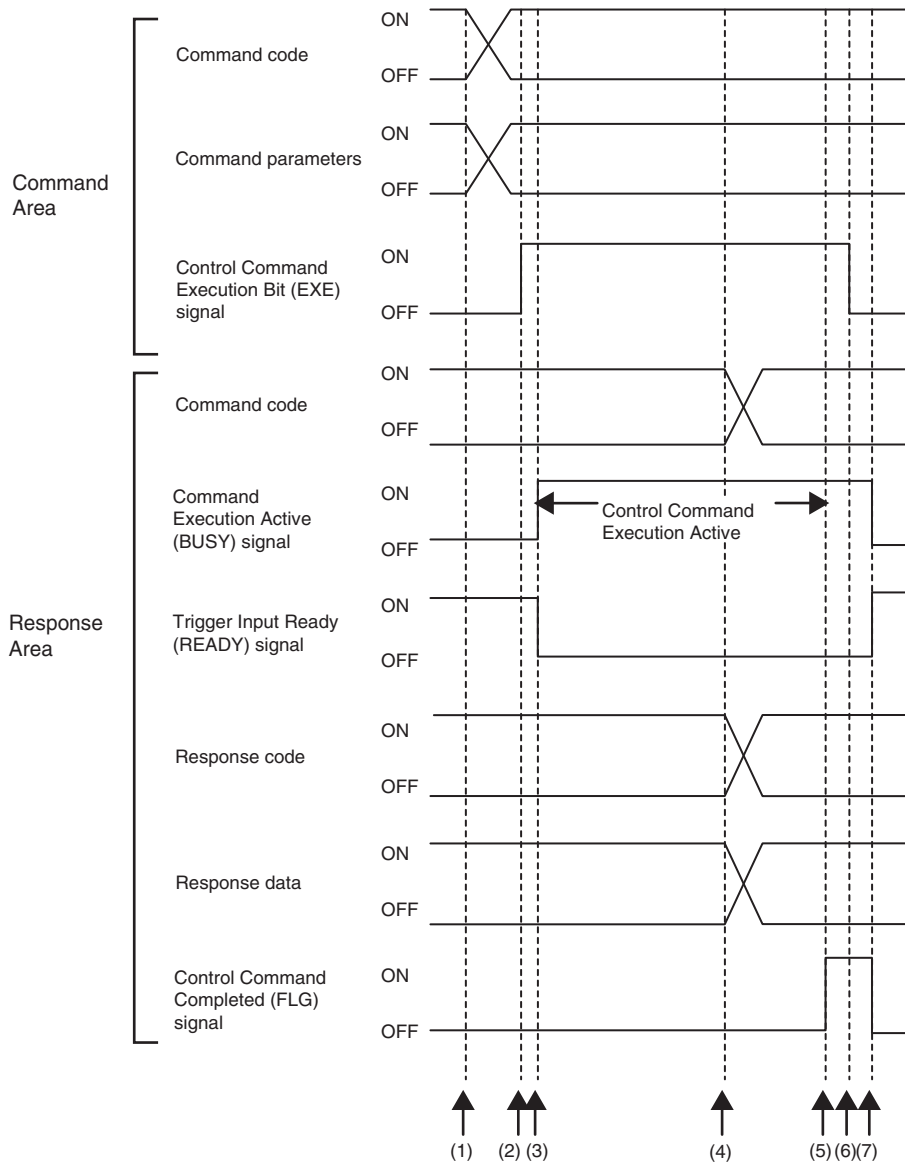

- (1) Set the command code and the command parameters from the PLC while the BUSY signal is OFF.
- (2) The Controller turns ON the Control Command Execution Bit (EXE) signal. The execution command is sent to the Vision Sensor.
- (3) When the Vision Sensor receives the execution command, the Command Execution Active (BUSY) signal turns ON, the Trigger Input Ready (READY) signal turns OFF, and the command is executed.
- (4) The command code, response code, and response data are set when the Vision Sensor completes execution of the command.
- (5) The Control Command Completed (FLG) signal turns ON.
- (6) When the PLC detects that the Control Command Completed (FLG) signal is ON, it turns OFF the Control Command Execution Bit (EXE) signal.
- (7) When the Vision Sensor detects that the Control Command Execution Bit (EXE) signal is OFF, it automatically turns OFF the Control Command Completed (FLG) signal and the Command Execution Active (BUSY) signal, and turns ON the Trigger Input Ready (READY) signal.

● Execution of Control Commands for Continuous Measurements with the Control Command Execution Bit (EXE) Signal

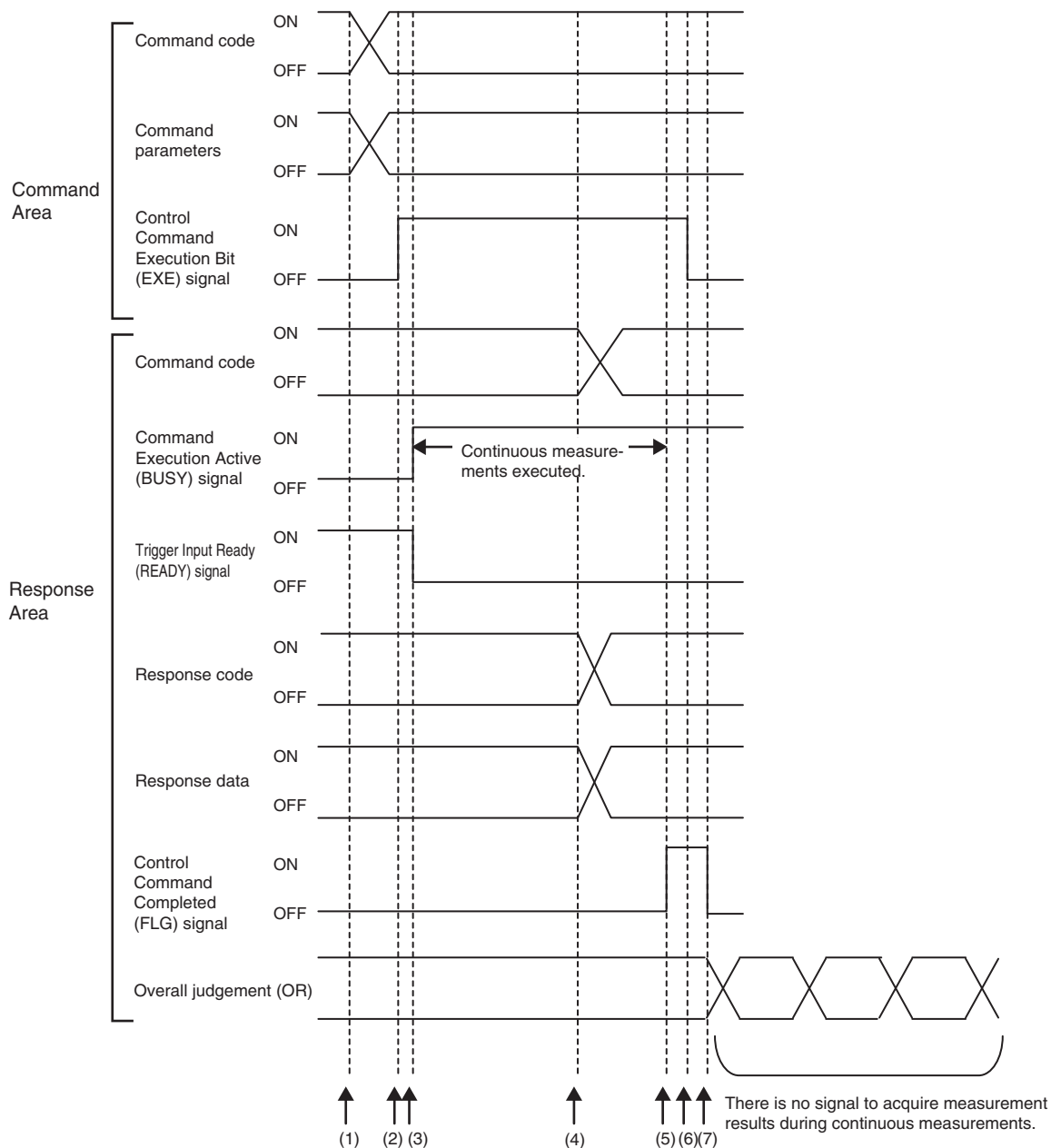

- (1) Set the Start Continuous Measurements command code and the command parameters from the PLC while the BUSY signal is OFF.
- (2) The Controller turns ON the Control Command Execution Bit (EXE) signal. The execution command is sent to the Vision Sensor.
- (3) When the Vision Sensor receives the execution command, the Command Execution Active (BUSY) signal turns ON, the Trigger Input Ready (READY) signal turns OFF, and the command is executed. Continuous measurements start at this time.
- (4) The command code, response code, and response data are set when the Vision Sensor completes execution of the command.
- (5) The Control Command Completed (FLG) signal turns ON.
- (6) When the PLC detects that the Control Command Completed (FLG) signal is ON, it turns OFF the Control Command Execution Bit (EXE) signal.
- (7) When the Vision Sensor detects that the Control Command Execution Bit (EXE) signal is OFF, it automatically turns OFF the Control Command Completed (FLG) signal. The BUSY signal remains ON until continuous measurements are completed.
- (8) During continuous measurements, an OR of the measurement results is output each time a measurement is completed.

Note

During execution of continuous measurements, the BUSY signal remains ON. The Vision Sensor will acknowledge the EXE signal only after the End Continuous Measurements command is executed.

● Data Output after Measurements When Handshaking Is Enabled

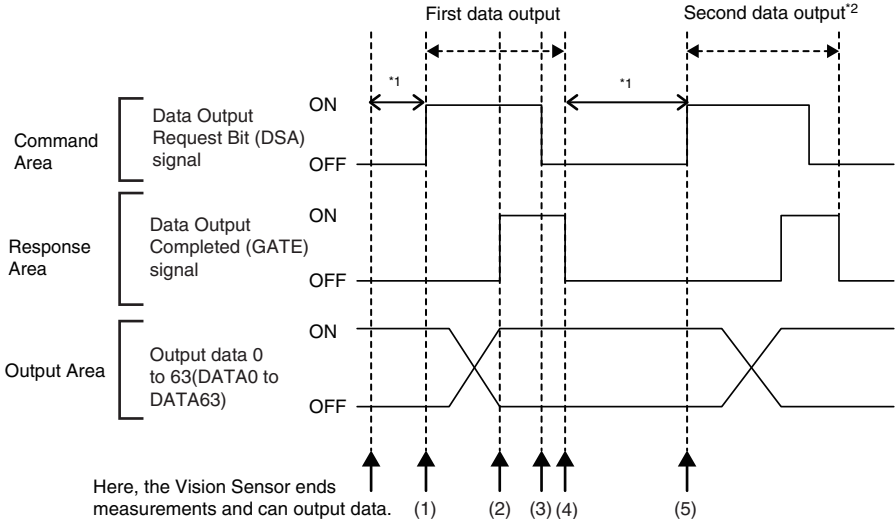

- (1) After measurements are completed, the Data Output Request Bit (DSA) signal is turned ON by the PLC and a request is made to the Vision Sensor to output the data.
 - (2) The Vision Sensor outputs the data. After the data is output, the Data Output Completed (GATE) signal turns ON.
 - (3) The master confirms that the Data Output Completed (GATE) signal has turned ON, loads the data, and turns OFF the Data Output Request Bit (DSA) signal.
 - (4) When the Vision Sensor detects that the Data Output Request (DSA) signal is OFF, it automatically turns OFF the Data Output Completed (GATE) signal.
 - (5) The Data Output Request Bit (DSA) signal is turned ON from the PLC and a request is made to output the data.
- *1 If the data output request signal is not manipulated within the control timeout time (100 to 120,000 ms) in the PROFINET settings, and data output error will occur and the ERR signal will turn ON. When the ERCLR signal is turned ON, the ERR signal will turn OFF. However, if a timeout occurs again, the ERR signal will turn ON again. Therefore, correctly request data output (DSA control) or execute a Clear Data Output Buffer command.
- *2 Indicates that the data to output is separated and output more than once.

● Data Output after Measurements When Handshaking Is Disabled

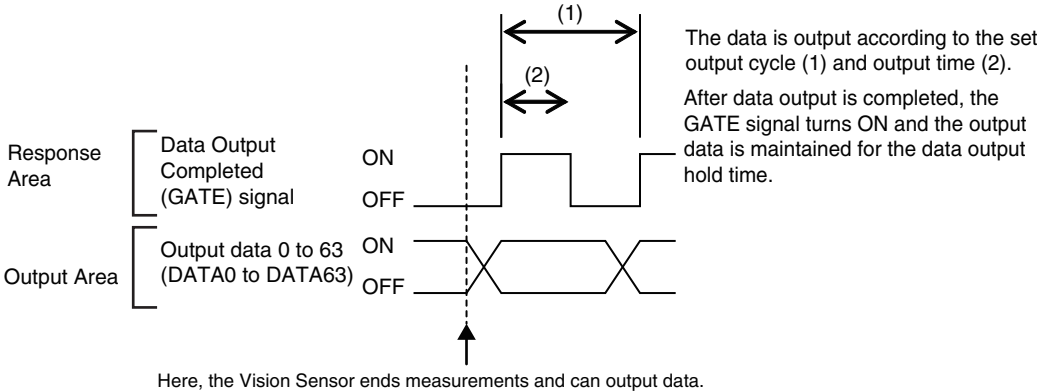

Important

Set the parameters so that the following conditions are met for the data output period and time.

- Set the data output period so that it is longer than the GATE signal ON period and shorter than the measurement interval of the Sensor.
- Set the “GATE signal output time” to a longer time than the PLC cycle time and the “PROFINET communication cycle”.
- When operating under high-load conditions, a considerable leeway is required in the measurement interval to enable stable communications.
- On a network to which many devices are connected, performance may drop (e.g., responses may be delayed or packets lost) or communications errors may occur when there is temporarily high traffic on the network. Test the operation under actual conditions before you start actual operation of the system.
- If the measurement interval is short, communications errors may occur depending on the measurement processing time of the Sensor and the settings in the PLC. Set the timeout time in the connection settings*1 so that it is longer than the measurement processing time of the Sensor or increase the measurement interval.

*1 These are the connection settings for tag data links. Make these settings from the Network Configurator.

Sample Ladder Programming

● Command/Response Communications

The following sample program is used to clear measurement values.

The Clear Measurement Values command (lower bytes: #2010, upper bytes: #0010) is sent to the Vision Sensor.

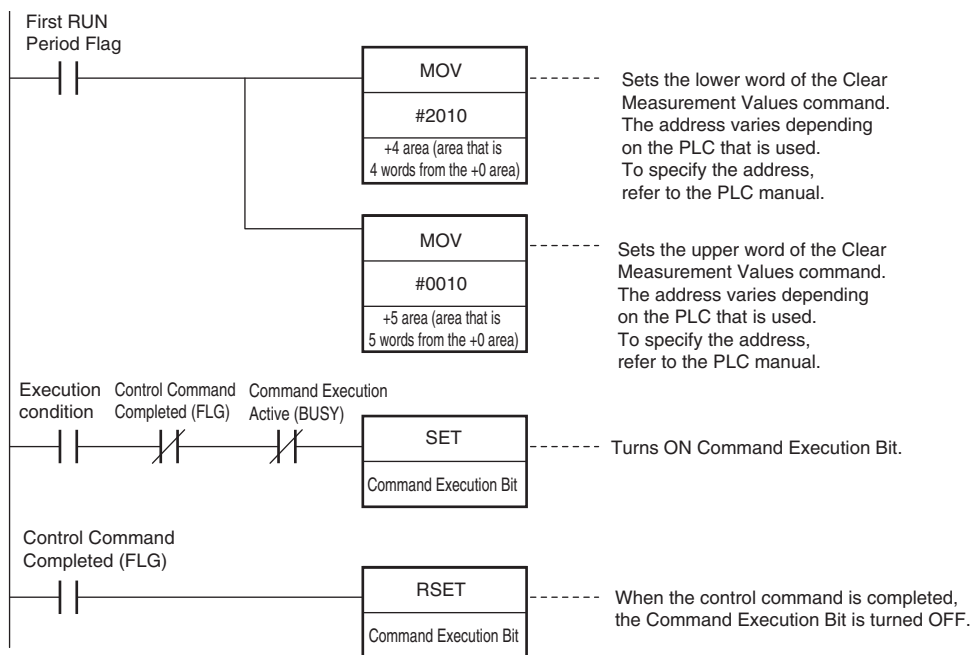

Important

Create the ladder program to control the TRIG signal so that it does not turn ON while the BUSY signal is ON. If not, a TRIG input error will occur and the ERROR signal will turn ON.

Note

While the trigger input (TRIG signal) for parallel measurements is ON, the PROFINET BUSY signal will also be ON. Therefore, no PROFINET commands will be executed. Any PROFINET commands will be executed after execution of the parallel commands. You can also use a PROFINET to perform measurements and output data with the parallel I/O measurement trigger signal (TRIG).

● Data Output after Measurements When Handshaking Is Enabled

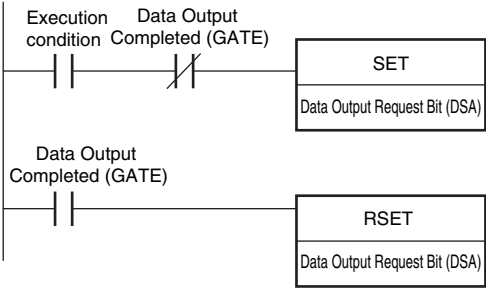

3-4 Control and Output in No-Protocol (TCP) / No-Protocol (UDP)

FQ2-S1

FQ2-S2

FQ2-S3

FQ2-S4

FQ2-CH

This section explains communication settings, input formats, and other information necessary to communicate with the sensor and external devices using no-protocol communication.

Communications Processing Flow

You can use no-protocol communications between an external device (such as a PLC) and the Vision Sensor to perform control from the external device via command/response communications or to output data after measurements. You can use these communications methods simultaneously.

Control by command/response is accomplished by issuing ASCII text commands (example: "MEASURE" for single measurement) from the external device (PLC, etc.). The Vision Sensor returns a response such as "OK", "NG", or values.

Data output by the data output method after measurement is in ASCII format or binary format, and is sent to the external device (PLC, etc.) serially. There is no handshake to determine whether the external device (PLC, etc.) is ready to receive the data.

Setting Up No-protocol Communications

Setting Network Settings in the Sensor

Set the IP address of the Sensor according to the network where the external devices, such as PLCs, are connected.

▶  (Setup Mode) – [Sensor settings] – [Network] – [Ethernet] – [IP address setting]

- 1 Press [Fixed].
- 2 Set the IP address and subnet mask according to the network where the external devices, such as PLCs, are connected.

Note

If you connect OMRON CS/CJ-series PLCs to the Ethernet, the following default IP addresses are assigned to the PLCs.

- IP address: 192.168.250.*node_address*

Initial Settings for No-protocol Communications

You must set the communications method of the destination external device to perform no-protocol communications.

▶ [Sensor settings] – [Data output] – [No-protocol data]

- 1 Press [No protocol (TCP)] or [No protocol (UDP)].

- 2 If you selected [No protocol (TCP)], select [TCP server] or [TCP client] for [Connection mode] and then press [Back].
- 3 If you selected [No protocol (UDP)] or set [Connection mode] to [TCP client] in step 2, set the parameters below.

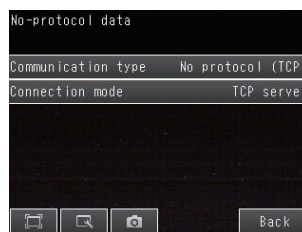

Initial settings for no protocol communications

Items to set and their default values depend on the communication protocol used and connection mode set.

Communication protocol used and connection mode set	Item	Description	Setting range
No protocol (TCP) TCP server	Input port No.	Sets the input port number to wait for a connection request from the connected external device (or client) such as a PLC. In this connection mode, an FQ2 Sensor serves as a TCP server and monitors this port number to be ready for the connection request from the client.	0 to 65,535 Default: 9,876
	Output IP address	Sets the IP address of the connected external device (PLC, etc.).	a.b.c.d a: 1 to 223 b: 0 to 255 c: 0 to 255 d: 1 to 254 Default: 10.5.5.111
No protocol (TCP) TCP client	Output port No.	Sets the port number to be used for exchanging data with the connected external device (or client) such as a PLC. Set the same port number as the port number set for the connected external device.	0 to 65,535 Default: 9,600
	Input port No.	Sets the port number used for data inputs. Set the same port number as the port number set for the connected external device.	0 to 65,535 Default: 9,600
	Output IP address	Sets the IP address of the connected external device (PLC, etc.).	a.b.c.d a: 1 to 223 b: 0 to 255 c: 0 to 255 d: 1 to 254 Default: 10.5.5.111
No protocol (UDP)	Output port No.	Sets the port number used for data outputs. Set the same port number as the port number set for the connected external device.	0 to 65,535 Default: 9,600
	Input port No.	Sets the port number used for data inputs. Set the same port number as the port number set for the connected external device.	0 to 65,535 Default: 9,600
	Output IP address	Sets the IP address of the connected external device (PLC, etc.).	a.b.c.d a: 1 to 223 b: 0 to 255 c: 0 to 255 d: 1 to 254 Default: 10.5.5.111

Setting the Data to Output Automatically after Measurements

You can set the data to output automatically after measurements. (You can set up to 32 data items.)

Data That Can Be Output

- Data Output

On the FQ2, data output after measurement can be assigned to Data 0 to Data 31 in the output data settings.

The data of items assigned in the output data settings are output in units of 4 bytes per item.

The measurement data from inspection items that can be output and the calculation results from the expression settings can be output. For data that can be output, refer to the *Measurement Data That Can Be Used for External Outputs and Calculations* for each inspection item.



Assigning Inspection Results to Output Data: p. 170

Assigning More Than One Inspection Result to the Same Output Data: p. 170

- Character Output (Only Supported on the FQ2-S4/CH)

You can output a character string that contains up to 1,024 characters for each of the inspection item that reads a character string, such as the OCR inspection item. Also, when reading the character string fails, you can output a specific character string that is set in advance.



Outputting Read Character Strings: p. 175

Assigning Inspection Results to Output Data

You can individually assign the parameters of the inspection items to output data (data 0 to data 31). The following procedure shows how to assign the measured position X of [0. Search] to data 0 for a binary output.

► [In/Out] – [I/O setting] – [Output data setting] – [Link data output] – [Output data set]

- 1 Press [0. Data 0].
- 2 Press [Data setting].
- 3 Press [I0. Search].
- 4 Press [Position X X].

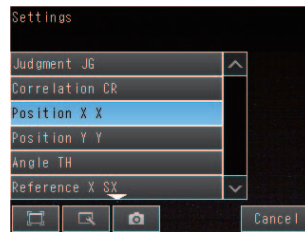

- 5 If the inspection item allows multi-point output, press the number ([0] to [31]) of the inspection result for which to output the data from the list of inspection results.

To register something to data 1 and higher, repeat this process.

The settings will be enabled after you restart the Sensor.

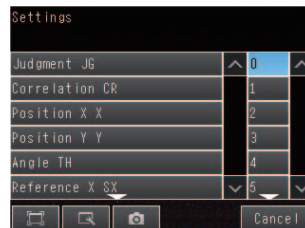

Assigning More Than One Inspection Result to the Same Output Data

You can assign more than one inspection result to the same data output to output all of the assigned results. This is possible for the following inspection results.

- Parameters for the same inspection item: You can assign up to five inspection results.
- Inspection results that support multi-point output: You can assign inspection results within the specified range (0 to 31).

The following procedure shows how to assign more than one inspection result to data 0.

► [In/Out] – [I/O setting] – [Output data setting] – [Link data output] – [Output data set]

- 1 Press [0. Data 0].
- 2 Press [Multi-data].

3 Set the following items on the display to set expressions.

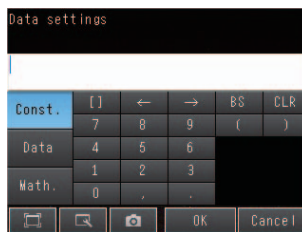

Item	Description
Expression	Register the expression to use to output multiple data. Examples: LPR (0, 3, I0.X, I0.Y) LPC (0, I0.C, I0.X, I0.Y)
Const.	Used to insert numbers and symbols into the expression.
Data	Used to select the inspection items for which to output data and insert the parameters to output into the expression. Example: Selecting Parameters for the Search Item at Inspection Item 0 Inspection item: I0. Search Judgement result: Judgement JG, Correlation: Corre. CR
Math.	Either of the following two functions can be inserted. <ul style="list-style-type: none"> • LPR function (order of the measurement data) The measurement data is output in order. Format: LPR(<i>start_number, number_of_data, data_1, data_2, ... data_5</i>) You can omit data 2 to data 5. • LPC function (order of the detection points) Data is output for each detected measurement point. Format: LPC(<i>start_number, number_of_data, data_1, data_2, ... data_5</i>) You can omit data 2 to data 5.

**To register something to data 1 and higher, repeat this process.
The settings will be enabled after you restart the Sensor.**

● Expression Setting Example

This example registers an expression to output the following inspection results for data 0.

Inspection item: 0 Search

Parameters to output: Position X, Position Y, Reference SX, and Reference SY

Multi-point output setting: Multi-point output Check Box selected, Count = 4

LPR(0,I0.C,I0.X,I0.Y,I0.SX,I0.SY)

Function | Number_of_data (Detection count) | data_A, data_B...data_d
Start_number

Output Results

The data for 16 items (64 bytes) is output in the following order for the expression that is registered for data 0.

Output order ^{*1}	Assigned data
1	I0.X[0] (Position X 1st point)
2	I0.Y[0] (Position Y 1st point)
3	I0.SX[0] (Reference SX 1st point)
4	I0.SY[0] (Reference SY 1st point)
5	I0.X[1] (Position X 2nd point)

Output order ^{*1}	Assigned data
6	I0.Y[1] (Position Y 2nd point)
7	I0.SX[1] (Reference SX 2nd point)
8	I0.SY[1] (Reference SY 2nd point)
9	I0.X[2] (Position X 3rd point)
10	I0.Y[2] (Position Y 3rd point)
11	I0.SX[2] (Reference SX 3rd point)
12	I0.SY[2] (Reference SY 3rd point)
13	I0.X[3] (Position X 4th point)
14	I0.Y[3] (Position Y 4th point)
15	I0.SX[3] (Reference SX 4th point)
16	I0.SY[3] (Reference SY 4th point)

*1 The inspection results will be output according to the sorting method that is set for multi-point output for the inspection item.

Note

- In order to output multiple detection results of the inspection items that can be output their results simultaneously, from the [Inspection] menu of the targeted inspection item, press [Multi-point output] and select [Yes].

Setting the Output Format

► [In/Out] – [I/O setting] – [Output data setting] – [Noprotocol data output]

- Press [Output format].
- Set [Output form] to [ASCII] or [Binary].
- Set the data format for the data form that you selected.

ASCII

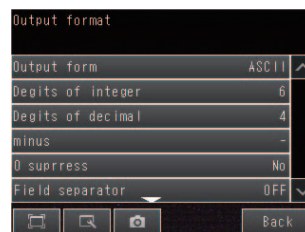

Binary

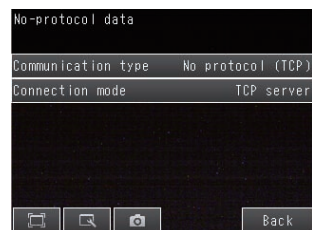

Item		Description	Setting range
For ASCII	Digits of integer	Sets the number of digits in the integer part of the number.	1 to 10 digits Default: 6 digits
	Digits of decimal	Set the number of digits in the integer part.	0 to 4 digits Default: 4 digits
	Negative	Sets the way to express negative numbers.	- or 8 Default: -
	0 Suppressed	Sets whether to use zero suppression.	Yes or No Default: No
	Field separator	Sets the field separator.	OFF, comma, tab, space, CR, LF, or CR+LF Default: OFF
	Record separator	Sets the record separator.	OFF, comma, tab, space, CR, LF, or CR+LF Default: OFF
For Binary	Decimal output form	Set the decimal output form for numerical data.	Floating point or fixed point (default: Fixed point)

- When Output Format Is ASCII

Set the parameters for integer digits, decimal digits, negative numbers, 0 suppression, the field separator, and the record separator.

- Output Format

Measured value of data 0	,	Measured value of data 1	,	...	Measured value of data 7	CR
--------------------------	---	--------------------------	---	-----	--------------------------	----

Note

The data output method, digits, and data separators can be changed as needed.

Example: Integer digits: 5, decimal digits: 3, negative number expression: -, zero suppressed: none, field separator: comma, record separator: CR

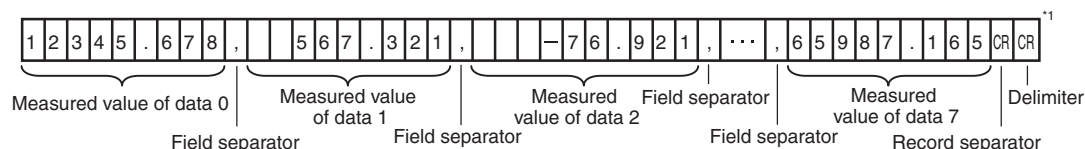

*1 Because the record separator is set to CR, only one record is output for each measurement. A blank line (CR: delimiter) will therefore be entered after the record separator. If you do not want a blank line, set the record separator to None.

Note

The field separator is not output unless the data continues.

The following range of values can be output.

$$-999,999,999.9999 \leq \text{Measured value} \leq 999,999,999.9999$$

If the measured value is lower than -999,999,999.9999, then -999,999,999.9999 is output.

If the measured value is higher than 999,999,999.9999, then 999,999,999.9999 is output.

The following values are output if JG (Judge) is set.

- OK: 0
- NG: -1

Note

Data that is output after measurement is output until the last data even after the measurement is finished. Data output is not interrupted midway.

- **When Output Format Is Binary**

Set the numerical expression.

Select either fixed decimal or floating-point decimal.

- **Output Format**

<Measured value of data 0 × 1,000><Measured value of data 1 × 1,000>...<Measured value of data 7 × 1,000> CR
 4 bytes 4 bytes 4 bytes Delimiter

The measurement data multiplied by 1,000 is output continuously at 4 bytes per data. Negative numbers are output as two's complements.

Example: When Data 0 Is 256.324 and Data 1 Is -1.000.

\$00 \$03 \$E9 \$44 \$FF \$FF \$FC \$18 \$0D
 Data 0: 256324 (256.324 × 1000) Data 1: -1000 (-1.000 × 1000) A delimiter will be attached to the end.

Note

Binary output does not use data separators, i.e., field separators or record separators. These separators are used only for ASCII output.

The following range of values can be output.

-2,147,483.648 ≤ Measured value ≤ 2,147,483.647

If the measured value is lower than -2,147,483.648, then -2,147,483.648 is output.

If the measured value is higher than 2,147,483.647, then 2,147,483.647 is output.

The following values are output if JG (Judge) is set.

OK: 0 (0 × 1000)

NG: -1000 (-1 × 1000)

Note

Data that is output after measurement is output until the last data even after the measurement is finished. Data output is not interrupted midway.

Outputting Character Strings (Only Supported on the FQ2-S4/CH)

You can set whether to output the character string that results from reading. Outputting the character string is possible for the following inspection results.

- OCR
- Bar code
- 2D-code
- 2D-code (DPM)

The procedure for outputting the character string is given here for two inspection items.

▶ **[In/Out] – [I/O setting] – [Output data set] – [No-protocol data output] – [Output data set]**

- 1** Select the inspection item for which to output the character string.
- 2** Set the following items on the setting display.

Parameter	Set value	Description
String output ON/OFF	No (default) Yes	Sets whether to output the character string that results from reading.
Line delimiter	OFF (default) Comma Space	Sets the character to use for the line delimiter. * This setting is enabled only when the OCR inspection item is selected.
Partial output ON/OFF	No (default) Yes	Sets whether to specify the range of characters to output.
Output string setup	1 to 128 for OCR 1 to 1024 for Bar code, 2D-code, or 2D-code (DPM)	Sets the output range.
NG String output on/off	Yes (default) No	Sets whether to output an NG string.

Note

- Endian
Little endian data is output.
- Code Conversion
The converted codes are outputted for the following character codes.

Character code	Before conversion	After conversion
CR	&h0D	&h8541
LF	&h0A	&h8542
DEL	&h7F	&h8543
FF	&hFF	&h8544

Command Format

This section describes the command format for no-protocol communications.

Commands defined in the command list can be used.

Set commands and parameters in ASCII.

If the command has an argument parameter, set the parameter after inserting a space (0x20).

If it has multiple parameters, insert a space before each parameter.

Place a delimiter at the end of the command. No space is required before the delimiter.

The delimiter is always CR.

<Command Format>

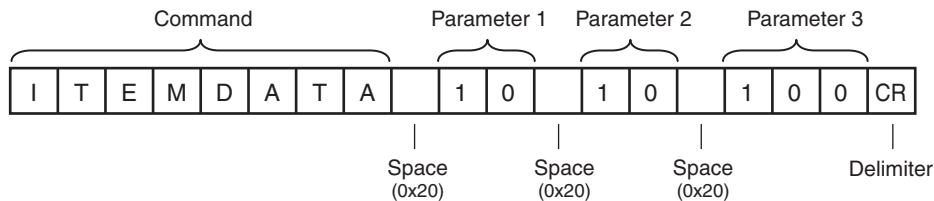

<Response Format>

If a parameter is attached, the parameter and delimiter are output when the command is processed normally, and the command execution result is OK. A delimiter is inserted at the end of the response.

The delimiter is always CR.

Command Execution Result

Parameter

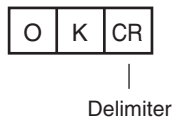
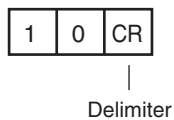

If the command is not processed normally, the command execution result is NG.

Command Execution Result

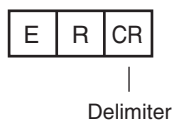

An error occurs in the following cases.

- A non-existent command was specified.
- The number of parameters is incorrect.
- The parameter range is incorrect.
- The parameter content is incorrect.
- Operation could not be performed normally for the operation command.

Format of no-protocol (UDP) commands

Delimiters are not necessary in commands used in no-protocol (UDP) communication.

Delimiters are also not used in responses. In cases such as a Get Scene Number command where the acquired data is followed by an OK response, the acquired data and OK are sent in separate packets.

Command List (No-protocol (TCP), No-protocol (UDP))

The following table lists the no-protocol commands.

Commands that can be used in no-protocol Ethernet communications are listed below.

Type of command	Command	Abbreviation	Function	Reference
Execution commands	CLRERR	None	Clears the error output status (error output and error indicator).	p.263
	CLRMEAS	None	Clears the measurement values.	p.263
	CLRTOTAL	CTD	Clears the statistical data	p.264
	DATASAVE	None	Saves the current setting data (system data, scene groups, and calibration data) in the Sensor.	p.264
	ECHO	EEC	Returns any data (32 bits or 2 words) sent by the external device as-is.	p.265
	ITEMTEACH	IT	Updates the reference data for the specified inspection item.	p.265
	MEASURE	M	Executes one measurement.	p.268
	MEASURE /C	M /C	Starts continuous measurements.	p.266
	MEASURE /E	M /E	Ends continuous measurements.	p.267
	MODEL	None	Re-registers the models for registered Search, Shape search II, Sensitive search, and Color data inspection items.	p.269
	POSITIONTEACH	PT	Updates reference data for the specified image adjustment processing item (filter item/position compensation item).	p.270
	REGIMAGE	RID	Sets the latest image or a specified logging image as a registered image.	p.271
	RESET	None	Restarts the Sensor.	p.272
	TEACH	None	Executes teaching for all registered items.	p.272
TIMER	TMR	Executes the specified command after the specified waiting time elapses.	p.273	

Type of command	Command	Abbreviation	Function	Reference
Execution commands	UPDATEREFIGITEM	URI	Re-registers the reference value for the specified inspection item based on the previously loaded image.	p.274
	UPDATEREFIGPOS	URP	Re-registers the reference value for the specified position compensation item based on the previously loaded image.	p.275
Commands to get status	SCENE	S	Acquires the scene number currently being used.	p.276
Commands to set status	SCENE	S	Changes the scene number to be used.	p.277
Commands to read data	CAMDATA	CD	Acquires the value of the specified camera parameter.	p.278
	DICNOLIST	DNL	Acquires the list of registered dictionary data numbers.	p.279
	DIOFFSET	DIO	Acquires the terminal offset data that is added to the IN0 to IN4 command parameters when executing parallel commands.	p.280
	DIPORTCOND	DPC	Batch acquires the ON/OFF status for the IN terminals.	p.281
	ERRGET	None	Acquires the Sensor's most recent error code.	p.282
	GETITEMFIG-PARAM	GIFP	Acquires the parameters for the measurement region or model registration region set for an inspection item.	p.283
	GETPOSFIG-PARAM	GPFP	Acquires the parameters for the measurement region or the model registration region set for an image adjustment item (filter item/position compensation item).	p.286
	GETDICFIGPARAM	GDFP	Acquires the specified dictionary data cutout region parameters.	p.289
	INPUTTRANS-STATE	ITS	Acquires the input status (allowed/prohibited) for the communications protocol set with the Set Communication Input Status command.	p.291
	ITEMDATA	ID	Acquires parameters and measurement values for the specified inspection item.	p.292
ITEMDATA2	ID2	Acquires the text string data of the specified inspection item.	p.293	

Type of command	Command	Abbreviation	Function	Reference
Commands to read data	MODE	None	Acquires the FQ2 execution status (execution mode).	p.294
	OUTPUTTRANS-STATE	OTS	Acquires the output status (allowed/prohibited) for the communications protocol set with the Set Communication Output Status command.	p.295
	PARAALLCOND	PAC	Batch acquires the ON/OFF status for the all parallel I/O input terminals other than the IN terminals.	p.296
Commands to Write Data	PARAPORTCOND	PPC	Acquires the input signal ON/OFF status for the specified parallel I/O terminal.	p.297
	POSITIONDATA	PD	Acquires data from a position compensation item or filter item.	p.299
	REGIMAGE	RID	Loads a registered image saved to the SD card or PC Tool as the measurement image.	p.300
	SYSDATA	SD	Acquires the value set for the specified system data.	p.301
	TOTALDATA	TD	Acquires the statistical data (such as the number of measurements, number of NG overall judgments, and other information, since the power supply was turned ON) held by the Sensor.	p.302
	VERGET /S	None	Acquires the version information of the Sensor software.	p.303
	VERGET /H	None	Acquires the Sensor model.	p.304
	CAMDATA	CD	Sets the value for the specified camera parameter.	p.305
	DIOFFSET	DIO	Sets the value of the terminal offset data that is added to the IN0 to IN4 command parameters	p.306
	DOPORTCOND	DPC	Batch sets the ON/OFF status for the D terminals (D0 to D15).	p.307
	INPUTTRANS-STATE	ITS	Sets the input status (allowed/prohibited) of the communications port for the specified communications protocol.	p.309
	DICDELETE	DD	Deletes one character from the characters registered in the model dictionary.	p.310
	DICREGIST	DR	Registers characters to the specified dictionary data.	p.311

Type of command	Command	Abbreviation	Function	Reference
Commands to Write Data	SETITEMFIG-PARAM	SIFP	Changes the range set as the measurement region or the model registration region for an inspection item.	p.312
	SETPOSFIG-PARAM	SPFP	Changes the range set as the measurement region or the model registration region for an image adjustment item (filter item/position compensation item).	p.314
	SETDICFIGPARAM	SDFP	Sets the specified dictionary data cutout region parameters.	p.317
	ITEMDATA	ID	Sets parameters for the specified inspection item.	p.319
	ITEMDATA2	ID2	Sets the text string data for the specified inspection item.	p.320
	MODE	None	Sets the FQ2 execution status (execution mode).	p.321
	OUTPUTTRANS-STATE	OTS	Sets the output status (allowed/prohibited) for the specified communications protocol.	p.322
	PARAALLCOND	PAC	Batch sets the ON/OFF status for the all parallel I/O output terminals other than the D terminals (D0 to D15).	p.323
	PARAPORTCOND	PPC	Sets the input signal ON/OFF status for the specified parallel I/O terminal.	p.325
	POSITIONDATA	PD	Sets parameters for a position compensation item or filter item.	p.327
	SYSDATA	SD	Sets the value to the specified system data.	p.328
Load setting data commands	SCNLOAD	None	Loads scene data that is stored on the SD card inserted in the Touch Finder.	p.329
	SGRLOAD	None	Loads all scene data that is stored on the SD card inserted in the Touch Finder.	p.330
	SYSLOAD	None	Loads system data that is stored on the SD card inserted in the Touch Finder.	p.331
	BKDLOAD	None	Loads all setting data (all scene data, system data, calibration group data) for the Sensor saved as a backup file from the SD card inserted in the Touch Finder.	p.332

Type of command	Command	Abbreviation	Function	Reference
Load setting data commands	CLBLOAD	None	Loads calibration data that is stored on the SD card inserted in the Touch Finder as the data for the specified calibration number.	p.333
	CGRLOAD	None	Loads all calibration data that is stored on the SD card inserted in the Touch Finder.	p.334
	DICLOAD	None	Loads model dictionary data that is stored on the SD card inserted in the Touch Finder as the model dictionary with the specified number.	p.335
	DGRLOAD	None	Loads all model dictionary data that is stored on the SD card inserted in the Touch Finder.	p.336
Save setting data commands	SCNSAVE	None	Saves scene data to the SD card inserted in the Touch Finder as a file.	p.337
	SGRSAVE	None	Saves all scene data as a file to the SD card inserted in the Touch Finder.	p.338
	SYSSAVE	None	Saves system data as a file to the SD card inserted in the Touch Finder.	p.339
	IMAGESAVE	None	Saves image data saved in the Sensor's memory by the logging function to the SD card inserted in the Touch Finder as ifz data.	p.340
	ALLIMAGESAVE	AIS	Saves all image data saved in the Sensor's memory by the logging function to the SD card inserted in the Touch Finder as ifz data.	p.341
	BKDSAVE	None	Saves all setting data (all scene data, system data, calibration group data) for the Sensor to the SD card inserted in the Touch Finder as a backup file.	p.342
	CLBSAVE	None	Saves the calibration data with the specified calibration number as a file to the SD card inserted in the Touch Finder.	p.343
	CGRSAVE	None	Saves all calibration data as a file to the SD card inserted in the Touch Finder.	p.343
	DICSAVE	None	Saves model dictionary data as a file to the SD card inserted in the Touch Finder.	p.344
DGRSAVE	None	Saves all model dictionary data as a file to the SD card inserted in the Touch Finder.	p.345	

Type of command	Command	Abbreviation	Function	Reference
Save setting data commands	LASTIMAGESAVE	LIS	Saves the latest input image to the SD card inserted in the Touch Finder as ifz data.	p.346
	LOGDATASAVE	LDS	Saves measurement data saved in the Sensor's memory by the logging function to the SD card inserted in the Touch Finder as csv data.	p.347
	TOTALDATASAVE	TDS	Saves statistical data saved in the Sensor's memory by the logging function to the SD card inserted in the Touch Finder as csv data.	p.348

Binary Data File Load and Save Commands

These commands allow various types of sensor data to be saved in binary data format.

Use these commands when you want to directly control scene data and system data from the external device side (user side) rather than the sensor side. For this purpose, a send/receive program is created on the user side, and the commands are incorporated into the program. Be sure to have a good understanding of binary data and the send/receive system before considering use of these commands.

These commands can also be used in no-protocol TCP communication. The commands cannot be used in no-protocol UDP communication or no-protocol RS-232C communication.

How to Execute Binary Data File Load/Save Commands

Two command types are available for these commands: check commands and run commands.

To execute one operation, control must be performed using a combination of the two types of commands.

- Check command: Sends notification of the size of the binary data to be saved or loaded.
- Run command: Executes saving or loading of binary data.

Important

If the check command is not executed, the run command that executes saving/loading of binary data will not be processed properly.

Using the Commands

Create the command send/receive program so that the check command is always executed before the run command. Command execution is accomplished by the user-created send/receive program that incorporates the check commands and run commands in the above order.

Saving and loading of binary data using check commands and run commands is as shown below.

Binary Data File Save Command

The flow below is used to save various types of setting files in an external device as data in binary data format.

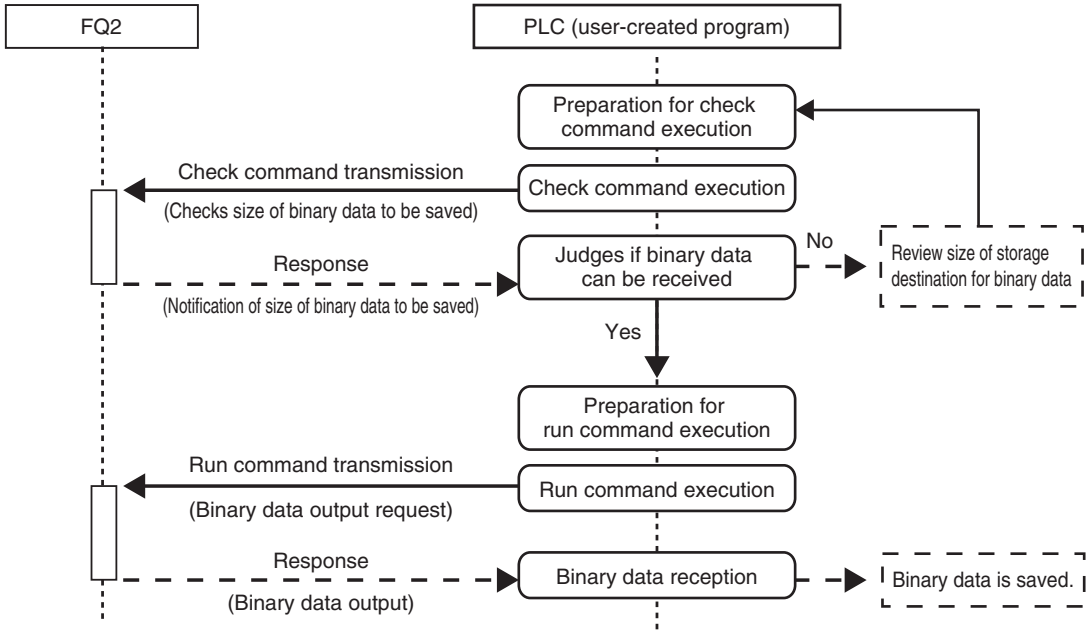

Binary Data File Load Command

The flow below is used to load various types of setting files in binary data format in the Sensor.

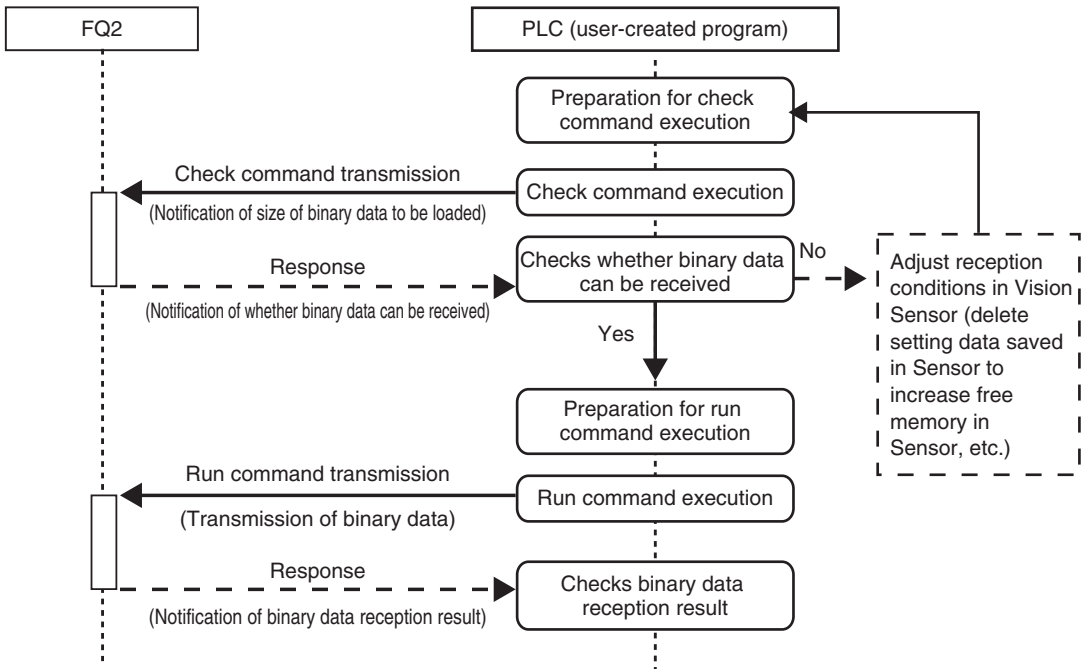

Command List (Load/Save Commands for Binary Data Files)

A table of load/save commands for binary data files is shown below.

Type of command	Command	Abbreviation	Function	Reference
Load commands for binary data files	PRESCNLOADB	None	Before loading scene data in binary data format, the Sensor checks whether or not it can receive binary data.	p.349
	SCNLOADB	None	Loads scene data in binary data format.	p.349
	PRESGRLOADB	None	Before loading all scene data in binary data format, the Sensor checks whether or not it can receive binary data.	p.350
	SGRLOADB	None	Loads all scene data in binary data format.	p.350
	PRESYSLOADB	None	Before loading system data in binary data format, the Sensor checks whether or not it can receive binary data.	p.351
	SYSLOADB	None	Loads system data in binary data format.	p.351
	PREBKDLOADB	None	Before loading all setting data for the Sensor in binary data format, the Sensor checks whether or not it can receive binary data.	p.352
	BKDLOADB	None	Loads all setting data for the Sensor in binary data format.	p.352
	PRECLBLOADB	None	Before loading calibration data in binary data format, the Sensor checks whether or not it can receive binary data.	p.354
	CLBLOADB	None	Loads calibration data in binary data format.	p.354
	PRECGRLOADB	None	Before loading all calibration data in binary data format, the Sensor checks whether or not it can receive binary data.	p.355
	CGRLOADB	None	Loads all calibration data in binary data format.	p.355
	PREDICLOADB	None	Before loading model dictionary data in binary data format, the Sensor checks whether or not it can receive binary data.	p.356
	DICLOADB	None	Loads model dictionary data in binary data format.	p.356
	PREDGRLOADB	None	Before loading all model dictionary data in binary data format, the Sensor checks whether or not it can receive binary data.	p.357
	DGRLOADB	None	Loads all model dictionary data in binary data format.	p.357

Type of command	Command	Abbreviation	Function	Reference
Save commands for binary data files	PRESCNSAVEB	None	Before scene data in binary data format is output, a check is performed to determine if the data can be received by the external device that will receive the data.	p.359
	SCNSAVEB	None	This command outputs the scene data in binary data format.	p.359
	PRESGRSAVEB	None	Before all scene data in binary data format is output, a check is performed to determine if the data can be received by the external device that will receive the data.	p.360
	SGRSAVEB	None	This command outputs all scene data in binary data format.	p.360
	PRESYSSAVEB	None	Before system data in binary data format is output, a check is performed to determine if the data can be received by the external device that will receive the data.	p.361
	SYSSAVEB	None	This command outputs system data in binary data format.	p.361
	PREBKDSAVEB	None	Before all setting data being used by the current Sensor is output in binary data format, a check is performed to determine if the data can be received by the external device that will receive the data.	p.363
	BKDSAVEB	None	This command outputs all setting data being used by the current Sensor in binary data format.	p.363

Type of command	Command	Abbreviation	Function	Reference
Save commands for binary data files	PREIMAGESAVEB	None	Before images saved to the Sensor's memory are output in binary data format, a check is performed to determine if the data can be received by the external device that will receive the data.	p.364
	IMAGESAVEB	None	Outputs image data stored in the Sensor memory in binary format.	p.364
	PREALLIMAGESAVEB	None	Before all images saved to the Sensor's memory are output in binary data format, a check is performed to determine if the data can be received by the external device that will receive the data.	p.365
	ALLIMAGESAVEB	None	Outputs all image data stored in the Sensor memory in binary format.	p.365
	PRECLBSAVEB	None	Before calibration data in binary data format is output, a check is performed to determine if the data can be received by the external device that will receive the data.	p.366
	CLBSAVEB	None	This command outputs the calibration data in binary data format.	p.366
	PRECGRSAVEB	None	Before all calibration data in binary data format is output, a check is performed to determine if the data can be received by the external device that will receive the data.	p.368
	CGRSAVEB	None	This command outputs the all calibration data in binary data format.	p.368
	PREDICSAVEB	None	Before model dictionary data is output in binary data format, a check is performed to determine if the data can be received by the external device that will receive the data.	p.369
	DICSAVEB	None	This command outputs model dictionary data in binary data format.	p.369
	PREDGRSAVEB	None	Before all model dictionary data is output in binary data format, a check is performed to determine if the data can be received by the external device that will receive the data.	p.370
	DGRSAVEB	None	This command outputs all model dictionary data in binary data format.	p.370

3-5 Controlling Operation and Outputting Data with FINS/TCP No-protocol Commands

FQ2-S1

FQ2-S2

FQ2-S3

FQ2-S4

FQ2-CH

Introduction to FINS Commands

FINS is a communications command system for a message service that is commonly used on OMRON networks.

Data can be sent and received and various controls, such as changing the operating mode, setting/resetting bits, and file operations, can be performed when necessary.

For details on FINS command specifications, the commands that are sent from a CPU Unit, and other information, refer to the *SYSMAC CS/CJ/CP/NSJ Series Communications Commands Reference Manual* (Cat. No. W342).

Range for Receiving FINS Commands

The FQ2 can receive FINS commands that are sent by an OMRON CPU Unit on the same Ethernet network. The FQ2 can send responses to the received commands to the CPU Unit that sent the commands. The FQ2 cannot receive FINS commands from any networks other than Ethernet or from devices on networks to which the FQ2 is not directly connected.

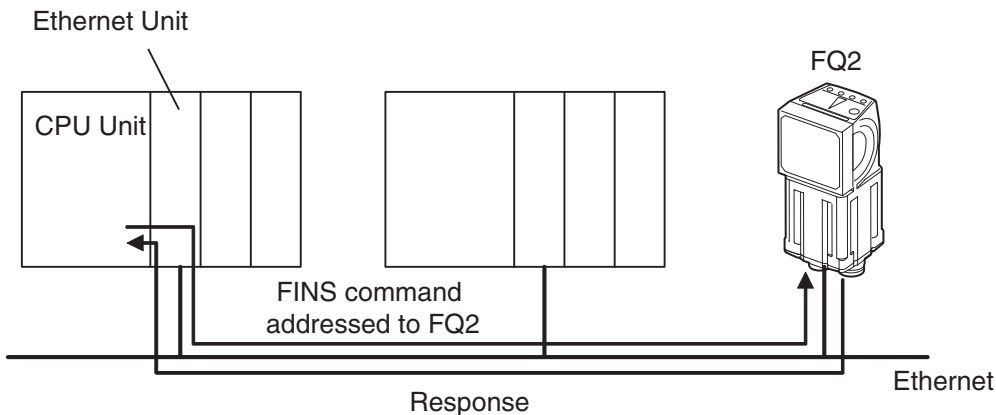

Sending FINS Commands

A special instruction for sending commands, the CMND instruction, is used to send FINS commands from the CPU Unit.

If you specify the FINS command code to send in the CMND instruction, the CPU Unit will attach the FINS header and send the FINS command frame.

When the CPU Unit receives the response from the Sensor, it automatically removes the FINS header and stores only the response data in the memory location that is specified in the CMND instruction.

Refer to the *SYSMAC CS/CJ/CP/NSJ Series Communications Commands Reference Manual* (Cat. No. W342) for more information on sending FINS commands with the CMND instruction.

● Setting the Destination in the CMND Instruction

To send a FINS command to the FQ2, the destination of the FINS command is specified in the control data of the CMND instruction.

Control data item	Setting
Destination network address	00 hex: Local network (The FINS commands must be sent to the local network.)
Destination node address	Specify the last two digits of the IP address of the FQ2.
Destination unit address	Always specify 00 hex.
Communications port number	Specify any communications port.
Serial port number	Always specify 00 hex.

● Command Codes for the FQ2

Command codes for the FQ2 consist of a 2-byte command code (which consists of an MRC and SRC) and a 4-byte Vision Sensor command code.

Example: Command Code for a Single Measurement Command

Command code		Vision Sensor command code (4 bytes)
MRC (1 byte)	SRC (1 byte)	
28	0F	00101010

Setting Up FINS/TCP No-protocol Communications

Setting Network Settings in the Sensor

Set the IP address of the Sensor according to the network where the external devices, such as PLCs, are connected.

▶  (Setup Mode) – [Sensor settings] – [Network] – [Ethernet] – [IP address setting]

- 1 Press [Fixed].
- 2 Set the IP address and subnet mask according to the network where the external devices, such as PLCs, are connected.

Note

If you connect OMRON CS/CJ-series PLCs to the Ethernet, the following default IP addresses are assigned to the PLCs.

- IP address: 192.168.250.*node_address*

Initial Settings for FINS/TCP No-protocol Communications

You must set the communications method of the destination external device to perform no-protocol communications.

► **[Sensor settings] – [Data output] – [No-protocol data]**

- 1** Press **[No protocol (FINS/TCP)]**.
- 2** Set **[Connection mode]** to either **[TCP server]** or **[TCP client]**. When you are finished, press **[Back]**.
- 3** If you set **[Connection mode]** to **[TCP client]**, set the following parameters.

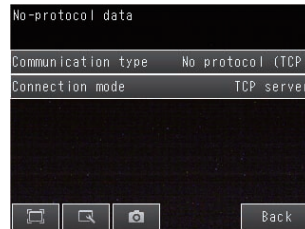

Initial settings for FINS communications

Items to set and their default values depend on the communication protocol used and connection mode set.

Communication protocol used and connection mode set	Item	Description	Setting range
No protocol (FINS/TCP) TCP server	Input port No.	Sets the input port number to wait for a connection request from the connected external device (or client) such as a PLC. In this connection mode, an FQ2 Sensor serves as a TCP server and monitors this port number to be ready for the connection request from the client.	0 to 65,535 Default: 9,876
No protocol (FINS/TCP) TCP client	Output IP address	Sets the IP address of the connected external device (PLC, etc.).	a.b.c.d a: 1 to 223 b: 0 to 255 c: 0 to 255 d: 1 to 254 Default: 10.5.5.111
	Port No.	Sets the port number to be used for exchanging data with the connected external device (or client) such as a PLC. Set the same port number as the port number set for the connected external device.	0 to 65,535 Default: 9,600

List of FINS Commands

Command List

The following table lists the FINS commands.

Commands that can be used in FINS Ethernet communications are listed below.

Type of command	Command codes (hex)		Function	Reference
	MRC+SRC command code	Vision Sensor command code		
Execution commands	280F	00101010	Executes one measurement.	p.372
	280F	00102010	Clears the measurement values.	p.373
	280F	00102040	Clears the error output status (error output and error indicator).	p.373
	280F	00102060	Clears the statistical data	p.374
	280F	00103010	Saves the current setting data (system data, scene groups, and calibration data) in the Sensor.	p.374
	280F	00104010	Re-registers the models for registered Search, Shape search II, Sensitive search, and Color data inspection items.	p.375
	280F	00104020	Performs teaching for all applicable items.	p.376
Execution commands	280F	00104021	Updates reference data for the specified image adjustment processing item (filter item/position compensation item).	p.377
	280F	00104022	Updates the reference data for the specified inspection item.	p.378
	280F	00104031	Re-registers the reference value for the specified position compensation item based on the previously loaded image.	p.379
	280F	00104032	Re-registers the reference values for the specified inspection item based on the previously loaded image.	p.380
	280F	00108010	Sets the latest image or a specified logging image as a registered image.	p.381
	280F	00108020	Loads a registered image saved to the SD card or PC Tool as the measurement image.	p.382
	280F	00109010	Returns the text string (half-width alphanumeric characters) sent by the external device as-is.	p.383
	280F	0010F010	Restarts the Sensor.	p.383
Scene control commands	280F	00201000	Acquires the scene number that is currently being used.	p.384
	280F	00301000	Changes the scene number to be used.	p.391

Type of command	Command codes (hex)		Function	Reference
	MRC+SRC command code	Vision Sensor command code		
Commands to get status	280F	00205000	Acquires the Sensor's most recent error code.	p.406
	280F	00207010	Acquires the input status (allowed/prohibited) for the communications protocol set with the Set Communication Input Status command.	p.385
	280F	00207020	Acquires the output status (allowed/prohibited) for the communications protocol set with the Set Communication Output Status command.	p.386
	280F	00208010	Acquires the input signal ON/OFF status for the specified parallel I/O terminal.	p.387
	280F	00208020	Batch acquires the ON/OFF status for the all parallel I/O input terminals other than the IN terminals.	p.388
	280F	00208030	Batch acquires the ON/OFF status for the IN terminals.	p.389
	280F	0020F000	Acquires the FQ2 execution status (execution mode).	p.390
	280F	00401010	Acquires parameters and measurement values for a position compensation item or filter item.	p.399
	280F	00401020	Acquires parameters and measurement values for the specified inspection item.	p.400
	280F	00401040	Acquires the value of the specified camera parameter.	p.402
	280F	00403000	Acquires the Sensor's software version.	p.401
	280F	00404010	Acquires the value set for the specified system data.	p.403
	280F	00404060	Acquires the terminal offset data that is added to the IN0 to IN4 command parameters when executing parallel commands.	p.404
	280F	00406010	Acquires the statistical data (such as the number of measurements, number of NG overall judgments, and other information, since the power supply was turned ON) held by the Sensor.	p.405

Type of command	Command codes (hex)		Function	Reference
	MRC+SRC command code	Vision Sensor command code		
Commands to set status	280F	00307010	Sets the input status (allowed/prohibited) of the communications port for the specified communications protocol.	p.392
	280F	00307020	Sets the output status (allowed/prohibited) for the specified communications protocol.	p.393
	280F	00308010	Sets the output signal ON/OFF status for the specified parallel I/O terminal.	p.394
	280F	00308020	Batch sets the ON/OFF status for the all parallel I/O output terminals other than the D terminals (D0 to D15).	p.396
	280F	00308030	Batch sets the ON/OFF status for the D terminals (D0 to D15).	p.397
	280F	0030F000	Sets the FQ2 execution status (execution mode).	p.398
	280F	00501010	Sets parameters for a position compensation item or filter item.	p.407
	280F	00501020	Sets parameters for the specified inspection item.	p.408
	280F	00501040	Sets the value for the specified camera parameter.	p.409
	280F	00504010	Sets the value to the specified system data.	p.410
	280F	00504060	Sets the value of the terminal offset data that is added to the IN0 to IN4 command parameters	p.411
Load setting data commands	280F	00601000	Loads scene data that is stored on the SD card inserted in the Touch Finder.	p.412
	280F	00602000	Loads all scene data that is stored on the SD card inserted in the Touch Finder.	p.413
	280F	00603000	Loads system data that is stored on the SD card inserted in the Touch Finder.	p.414
	280F	00605000	Loads all setting data (all scene data, system data, calibration group data) for the Sensor saved as a backup file from the SD card inserted in the Touch Finder.	p.415
	280F	0060A000	Loads calibration data that is stored on the SD card inserted in the Touch Finder as the calibration data with the specified number.	p.416
	280F	0060B000	Loads all calibration data that is stored on the SD card inserted in the Touch Finder.	p.417
	280F	0060C000	Loads model dictionary data that is stored on the SD card inserted in the Touch Finder as the model dictionary with the specified number.	p.418
	280F	0060D000	Loads all model dictionary data that is stored on the SD card inserted in the Touch Finder.	p.419
Save setting data commands	280F	00701000	Saves scene data to the SD card inserted in the Touch Finder as a file.	p.420
	280F	00702000	Saves all scene data as a file to the SD card inserted in the Touch Finder.	p.421
	280F	00703000	Saves system data as a file to the SD card inserted in the Touch Finder.	p.422
	280F	00704000	Saves image data saved in the Sensor's memory by the logging function to the SD card inserted in the Touch Finder as ifz data.	p.423

Type of command	Command codes (hex)		Function	Reference
	MRC+SRC command code	Vision Sensor command code		
Save setting data commands	280F	00704010	Saves all image data saved in the Sensor's memory by the logging function to the SD card inserted in the Touch Finder as ifz data.	p.424
	280F	00704020	Saves the latest input image to the SD card inserted in the Touch Finder as ifz data.	p.430
	280F	00705000	Saves all setting data (all scene data, system data, calibration group data) for the Sensor to the SD card inserted in the Touch Finder as a backup file.	p.425
	280F	0070A000	Saves the calibration data with the specified calibration number as a file to the SD card inserted in the Touch Finder.	p.426
	280F	0070B000	Saves all calibration data as a file to the SD card inserted in the Touch Finder.	p.427
	280F	0070C000	Saves the specified number of model dictionary data as a file to the SD card inserted in the Touch Finder.	p.428
	280F	0070D000	Saves all model dictionary data as a file to the SD card inserted in the Touch Finder.	p.429
	280F	00707000	Saves measurement data saved in the Sensor's memory by the logging function to the SD card inserted in the Touch Finder as csv data.	p.431
	280F	00708000	Saves statistical data saved in the Sensor's memory by the logging function to the SD card inserted in the Touch Finder as csv data.	p.432

Controlling Operation and Outputting Data with an RS-232C Connection

4-1 Introduction to RS-232C Connections	196
4-2 Controlling Operation and Outputting Data with RS-232C No-protocol Communications	197

4-1 Introduction to RS-232C Connections

FQ2-S3

FQ2-S4

FQ2-CH

You can connect an RS-232C Interface Sensor Data Unit to the I/O cable connector on the FQ2. If you connect a Sensor Data Unit, you can use no-protocol communications to send and receive commands, inspection item parameters, and other data between the Sensor and the external control device that is connected with the RS-232C cable.

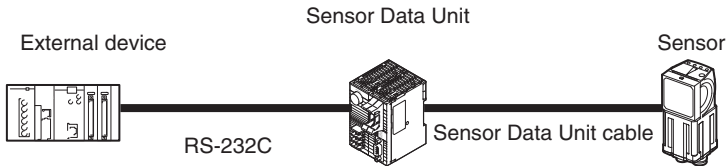

Refer to the following sections for the specifications and wiring methods of the RS-232C Interface Sensor Data Unit:

 Section 2 Installation and Connections
in Vision Sensor FQ2-S/CH Series User's Manual (Cat. No. Z337)

Note

Parallel Input Signals for an RS-232C Interface Sensor Data Unit

If you make a parallel connection through the parallel I/O connector on the Sensor Data Unit, the specifications of the parallel I/O signals will change as given below in respect to the standard parallel communications of the Sensor.

- Output Signals

You can use the ACK signal in the parallel outputs. Refer to the following section for the specifications of the ACK signal.

 2-2 Controlling Operation and Outputting Data with a Parallel Interface Sensor Data Unit: p. 60

4-2 Controlling Operation and Outputting Data with RS-232C No-protocol Communications

FQ2-S3

FQ2-S4

FQ2-CH

Communications Processing Flow

If you connect an RS-232C Interface Sensor Data Unit to the Vision Sensor, you can use no-protocol communications between an external device (such as a PLC) and the Vision Sensor to perform control from the external device via command/response communications or to output data after measurements.

You can use these communications methods simultaneously.

Control by command/response is accomplished by issuing ASCII text commands (example: "MEASURE" for single measurement) from the external device (PLC, etc.). The Vision Sensor returns a response such as "OK", "NG", or values.

Data output by the data output method after measurement is in ASCII format or binary format, and is sent to the external device (PLC, etc.) serially. There is no handshake to determine whether the external device (PLC, etc.) is ready to receive the data.

Setting Up No-protocol Communications

Initial Settings for No-protocol Communications

To perform no-protocol communications with RS-232C, you must set the communications baud rate, data length, and other RS-232C communications parameters.

► [Sensor settings] – [Data output] – [No-protocol data]

1 Press [Communication type] – [No protocol (RS-232C)].

2 Set the RS-232C communications parameters.

Note

If you connect to an OMRON PLC, set the PLC to Host Link communications.

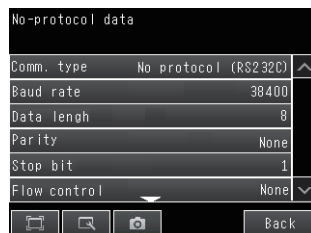

Item	Description	Parameter
Baud rate [bps]	Set the baud rate to use for RS-232C communications. Set the same baud rate as the external device that you will communicate with.	2400, 4800, 9600, 19200, 38400, 57600, or 115200 (default: 38400)
Data length [bits]	Set the same data length as the external device that you will communicate with.	7 bits or 8 bits (default: 8 bits)
Parity	Sets the parity. Set the same setting as the one in the PLC communications specifications.	None, Odd, or Even (default: none)
Stop bit	Set the number of stop bits. Set the same value as the one in the PLC communications specifications.	1 bit or 2 bits (default: 1 bit)
Flow control	Controls the flow of communications with the software.	None or Xon/Xoff (default: none)
Delimiter	Set the delimiter to add to the end of commands and responses. Set the same delimiter as the external device that you will communicate with.	CR, LF, or CR+LF (default: CR)

Item	Description	Parameter
Interval timeout	Set the time in seconds to generate a timeout error.	1 to 120 s, 0: Not monitored. (default: 0 s)
Total timeout	Set the time in seconds to generate a timeout error.	1 to 120 s, 0: Not monitored. (default: 0 s)

Setting the Data to Output Automatically after Measurements

You can set the data to output automatically after measurements. (You can set up to 32 data items.)

Data That Can Be Output

You can output up to 32 data items (data 0 to data 31).

The measurement data from inspection items that can be output and the calculation results from the expression settings can be output. For data that can be output, refer to the *Measurement Data That Can Be Used for External Outputs and Calculations* for each inspection item.

The setting procedure is the same as for no-protocol communications for an Ethernet connection.

 Setting the Data to Output Automatically after Measurements: p. 169

Important

Data Output Time and TRIG Signal Input Interval

Set the input interval for the TRIG signal so that it is equal to or greater than the data output time. If the input interval for the TRIG signal is shorter than the data output time, the output data buffer will eventually overflow and output data will be discarded.

Setting the Output Format

Set the output format for the output data.

The setting procedure and the data output formats are the same as for no-protocol communications for an Ethernet connection.

 Setting the Output Format: p. 172

Controlling the Sensor from an External Device (Procedure for No-protocol Command/Response Communications)

You can send commands from an external device to control the Sensor.

The commands and the command formats are the same as for no-protocol communications for an Ethernet connection.

 Controlling the Sensor from an External Device: p. 176

Appendices

5-1 Command Control	200
5-2 Detailed EtherNet/IP Communications Specifications	433
Index	438
Revision History	440

5-1 Command Control

This section describes the commands that are used to control the Sensor Controller from an external device.

Parameter Notation Examples for Command Control

This section provides examples of binary inputs of parameters and other arguments for command control.

Four-byte Data

The following example shows the input to change the scene to scene number 5 with the Switch Scene command.

First word in Command Area	Description
+2 and +3 words	Command code (1000 0030 hex)
+4 and +5 words	Scenes number 5 (0000 0005 hex)

Command (PLC to Sensor Controller)

First word in Command Area	Hexadecimal notation	Bits				Description
		12 to 15	8 to 11	4 to 7	0 to 3	
+2	1000	0001	0000	0000	0000	Command code
+3	0030	0000	0000	0011	0000	
+4	0005	0000	0000	0000	0101	Scene No.
+5	0000	0000	0000	0000	0000	

Specifying Character Strings

Specify the ASCII character code for every two bytes.

In this example, the inputs are given to save the image data for image data 1 to a destination specified by the file name (IMAGENAME.IFZ) with the Save Image command.

First word in Command Area	Description
+2 and +3 words	Command code (4000 0070 hex)
+4 and +5 words	Image data number 1 (0000 0001 hex)
+6 to +13 words	Save destination (IMAGENAME.IFZ)

Command (PLC to Sensor Controller)

First word in Command Area	Hexadecimal notation	Bits				Description
		12 to 15	8 to 11	4 to 7	0 to 3	
+2	4000	0100	0000	0000	0000	Command code
+3	0070	0000	0000	0111	0000	
+4	0001	0000	0000	0000	0001	Image data No.
+5	0000	0000	0000	0000	0000	
+6	4D49	0100	1101	0100	1001	File Name (IMAGENAME.IFZ) +6: MI(4D49) +7: GA(4741) +8: NE(4E45) +9: MA(4D41) +10: .E(2E45) +11: FI(4649) +12: Z(005A) +13:
+7	4741	0100	0111	0100	0001	
+8	4E45	0100	1110	0100	0101	
+9	4D41	0100	1101	0100	0001	
+10	2E45	0010	1110	0100	0101	
+11	4649	0100	0110	0100	1001	
+12	005A	0000	0000	0101	1010	
+13	0000	0000	0000	0000	0000	

Specifying Real Numbers

Specify 1,000 times the actual value to specify a real number.

In this input example, the lower limit (external reference number 137) of the measurement coordinate X of the Search registered in Unit No. 1 is set to "123.4" in the inspection item data setting command.

First word in Command Area	Description
+2 and +3 words	Command code (1020 0050 hex)
+4 and +5 words	Unit number 1 (0000 0001 hex)
+6 and +7 words	External reference number 137 (0000 0089 hex)
+8 and +9 words	Lower limit of measurement coordinate X: 123.4 (x 1,000: 123400 = 0001 E208 hex)

Command (PLC to Sensor Controller)

First word in Command Area	Hexadecimal notation	Bits				Description
		12 to 15	8 to 11	4 to 7	0 to 3	
+2	1020	0001	0000	0010	0000	Command code
+3	0050	0000	0000	0101	0000	
+4	0001	0000	0000	0000	0001	Unit No.
+5	0000	0000	0000	0000	0000	
+6	0089	0000	0000	1000	1001	External reference number
+7	0000	0000	0000	0000	0000	
+8	E208	1110	0010	0000	1000	Lower limit value of measurement coordinate X
+9	0001	0000	0000	0000	0001	

Command List

This section lists the commands that you can use with the FQ2 and the communications protocols for which each command is supported.

Execution Commands

OK: Applicable command, RST: Command with restricted execution, NA: Non-applicable command

Function	Parallel ☐ p. 46, p. 75	PLC link ☐ p. 132	EtherNet/ IP ☐ p. 109	PROFINET ☐ p. 156	No-protocol (TCP/ UDP/RS- 232C) ☐ p. 177	No-protocol (FINS) ☐ p. 191
Executes one measurement.	NA*	OK	NA*	NA*	OK	OK
Starts continuous measurements.	OK	OK	OK	OK	OK	NA
Ends continuous measurements.	OK	OK	OK	OK	OK	NA
Clears the measurement values.	OK	OK	OK	OK	OK	OK
Clears all data from the data output buffer of the Sensor.	NA	NA	OK	OK	NA	NA
Clears the error output status (error output and error indicator).	NA	NA	NA	NA	OK	OK
Clears the statistical data (such as the number of measurements, the number of NG overall judgments, the NG rate, and other information since the power supply was turned ON) produced by the logging function held by the Sensor.	NA	OK	OK	OK	OK	OK
Re-registers the reference values for all registered items based on the previously loaded image.	OK	OK	OK	OK	OK	OK
Executes teaching for all registered inspection items.	OK	OK	OK	OK	OK	OK
Updates reference data for the specified image adjustment processing item (filter item/position compensation item).	NA	OK	OK	OK	OK	OK
Updates the reference data for the specified inspection item.	NA	OK	OK	OK	OK	OK
Re-registers the reference value for the specified position compensation item based on the previously loaded image.	NA	OK	OK	OK	OK	OK
Re-registers the reference values for the specified inspection item based on the previously loaded image.	NA	OK	OK	OK	OK	OK
Sets the latest image or a specified logging image as a registered image.	NA	OK	OK	OK	OK	OK
Loads a registered image saved to the SD card or PC Tool as the measurement image.	NA	OK	OK	OK	OK	OK
Returns as is any character string sent by an external device.	NA	OK	OK	OK	OK	OK
Restarts the Sensor.	OK	OK	OK	OK	OK	OK
Executes the specified command after the specified waiting time elapses.	NA	NA	NA	NA	OK	NA
Turns the ERROR signal OFF.	OK	NA	NA	NA	NA	NA
Retries inspection by external signal.	OK	NA	NA	NA	NA	NA
Saves the current setting data (system data, scene groups, and calibration data) in the Sensor.	OK	OK	OK	OK	OK	OK
Clears the OR signal and D signals.	OK	NA	NA	NA	NA	NA

*: You can execute the same operation with the Measurement Execution Bit (parallel communications: TRIG) in the control signals.

Commands to Get Status

OK: Applicable command, RST: Command with restricted execution, NA: Non-applicable command

Function	Parallel ☐ p. 46, p. 75	PLC link ☐ p. 133	EtherNet/ IP ☐ p. 110	PROFINET ☐ p. 157	No-protocol (TCP/ UDP/RS- 232C) ☐ p. 178	No-protocol (FINS) ☐ p. 192
Acquires the scene number currently being used.	NA	OK	OK	OK	OK	OK

Commands to Set Status

OK: Applicable command, RST: Command with restricted execution, NA: Non-applicable command

Function	Parallel ☐ p. 46, p. 75	PLC link ☐ p. 133	EtherNet/ IP ☐ p. 111	PROFINET ☐ p. 157	No-protocol (TCP/ UDP/RS- 232C) ☐ p. 178	No-protocol (FINS) ☐ p. 193
Changes the scene number to be used.	OK	OK	OK	OK	OK	OK

Commands to Read Data

OK: Applicable command, RST: Command with restricted execution, NA: Non-applicable command

Function	Parallel ☐ p. 46, p. 75	PLC link ☐ p. 133	EtherNet/ IP ☐ p. 111	PROFINET ☐ p. 158	No-protocol (TCP/ UDP/RS- 232C) ☐ p. 178	No-protocol (FINS) ☐ p. 192
Acquires the list of registered dictionary data numbers.	NA	NA	NA	NA	OK	NA
Acquires parameters and measurement values for a position compensation item or filter item.	NA	OK	OK	OK	OK	OK
Acquires parameters and measurement values for the specified inspection item.	NA	OK	OK	OK	OK	OK
Acquires the text string data of the specified inspection item.	NA	NA	NA	NA	OK	NA
Acquires the value of the specified camera parameter.	NA	OK	OK	OK	OK	OK
Acquires the parameters for the measurement region or model registration region set for an inspection item.	NA	NA	NA	NA	OK	NA
Acquires the parameters for the measurement region or the model registration region set for an image adjustment item (filter item/position compensation item).	NA	NA	NA	NA	OK	NA
Acquires the specified dictionary data cutout region parameters.	NA	NA	NA	NA	OK	NA
Acquires the Sensor's software version.	NA	OK	OK	OK	OK	OK
Acquires the version information of the Sensor hardware.	NA	NA	NA	NA	OK	NA
Acquires the value set for the specified system data.	NA	OK	OK	OK	OK	OK
Acquires the terminal offset data that is added to the IN0 to IN4 command parameters when executing parallel commands.	NA	OK	OK	OK	OK	OK
Acquires the statistical data (such as the number of measurements, number of NG overall judgments, and other information, since the power supply was turned ON) held by the Sensor.	NA	OK	OK	OK	OK	OK
Acquires the Sensor's most recent error code.	NA	OK	OK	OK	OK	OK

OK: Applicable command, RST: Command with restricted execution, NA: Non-applicable command

Function	Parallel □ p. 46, p. 75	PLC link □ p. 133	EtherNet/ IP □ p. 111	PROFINET □ p. 158	No-protocol (TCP/ UDP/RS- 232C) □ p. 178	No-protocol (FINS) □ p. 192
Acquires the input status (allowed/prohibited) for the communications protocol set with the Set Communication Input Status command.	NA	OK	OK	OK	OK	OK
Acquires the output status (allowed/prohibited) for the communications protocol set with the Set Communication Output Status command.	NA	OK	OK	OK	OK	OK
Acquires the ON/OFF status of the input signal for the specified parallel I/O terminal.	NA	OK	OK	OK	OK	OK
Batch acquires the ON/OFF status for the all parallel I/O input terminals other than the IN terminals.	NA	OK	OK	OK	OK	OK
Batch acquires the ON/OFF status for the IN terminals.	NA	OK	OK	OK	OK	OK
Acquires the FQ2 execution status (execution mode).	NA	OK	OK	OK	OK	OK

Commands to Write Data

OK: Applicable command, RST: Command with restricted execution, NA: Non-applicable command

Function	Parallel □ p. 46, p. 75	PLC link □ p. 134	EtherNet/ IP □ p. 112	PROFINET □ p. 159	No-protocol (TCP/ UDP/RS- 232C) □ p. 179	No-protocol (FINS) □ p. 193
Registers characters to the specified dictionary data.	NA	NA	NA	NA	OK	NA
Deletes one character from the characters registered in the model dictionary.	NA	NA	NA	NA	OK	NA
Sets measurement values for a position compensation item or filter item.	NA	OK	OK	OK	OK	OK
Sets measurement values for the specified inspection item.	NA	OK	OK	OK	OK	OK
Sets the text string data for the specified inspection item.	NA	NA	NA	NA	OK	NA
Sets the value for the specified camera parameter.	NA	OK	OK	OK	OK	OK
Changes the range set as the measurement region or the model registration region for an inspection item.	NA	NA	NA	NA	OK	NA
Changes the range set as the measurement region or the model registration region for an image adjustment item (filter item/position compensation item).	NA	NA	NA	NA	OK	NA
Sets the specified dictionary data cutout region parameters.	NA	NA	NA	NA	OK	NA
Sets the value to the specified system data.	NA	OK	OK	OK	OK	OK
Sets the value of the terminal offset data that is added to the IN0 to IN4 command parameters	NA	OK	OK	OK	OK	OK
Sets the input status (allowed/prohibited) of the communications port for the specified communications protocol.	NA	OK	OK	OK	OK	OK
Sets the output status (allowed/prohibited) of the communications port for the specified communications protocol.	NA	OK	OK	OK	OK	OK
Sets the output signal ON/OFF status for the specified parallel I/O terminal.	NA	OK	OK	OK	OK	OK

OK: Applicable command, RST: Command with restricted execution, NA: Non-applicable command

Function	Parallel ☐ p. 46, p. 75	PLC link ☐ p. 134	EtherNet/ IP ☐ p. 112	PROFINET ☐ p. 159	No-protocol (TCP/ UDP/RS- 232C) ☐ p. 179	No-protocol (FINS) ☐ p. 193
Batch sets the ON/OFF status for the all parallel I/O output terminals other than the D terminals (D0 to D15).	NA	OK	OK	OK	OK	OK
Batch sets the ON/OFF status for the D terminals (D0 to D15).	NA	OK	OK	OK	OK	OK
Sets the FQ2 execution status (execution mode).	NA	OK	OK	OK	OK	OK

File Load Commands

OK: Applicable command, RST: Command with restricted execution, NA: Non-applicable command

Function	Parallel ☐ p. 46, p. 75	PLC link ☐ p. 135	EtherNet/ IP ☐ p. 112	PROFINET ☐ p. 159	No-protocol (TCP/ UDP/RS- 232C) ☐ p. 180, p. 185	No-protocol (FINS) ☐ p. 193
Loads scene data that is stored on the SD card inserted in the Touch Finder.	NA	OK	OK	OK	OK	OK
Loads all scene data that is stored on the SD card inserted in the Touch Finder.	NA	OK	OK	OK	OK	OK
Loads system data that is stored on the SD card inserted in the Touch Finder.	NA	OK	OK	OK	OK	OK
Loads all setting data (all scene data, system data, calibration group data) for the Sensor saved as a backup file from the SD card inserted in the Touch Finder.	NA	OK	OK	OK	OK	OK
Loads calibration data that is stored on the SD card inserted in the Touch Finder as the specified calibration number.	NA	OK	OK	OK	OK	OK
Loads all calibration data that is stored on the SD card inserted in the Touch Finder.	NA	OK	OK	OK	OK	OK
Loads model dictionary data that is stored on the SD card inserted in the Touch Finder as the model dictionary with the specified number.	NA	OK	OK	OK	OK	OK
Loads all model dictionary data that is stored on the SD card inserted in the Touch Finder.	NA	OK	OK	OK	OK	OK
Loads scene data in binary data format.	NA	NA	NA	NA	OK*	NA
Loads all scene data in binary data format.	NA	NA	NA	NA	OK*	NA
Loads system data in binary data format.	NA	NA	NA	NA	OK*	NA
Loads all setting data for the Sensor in binary data format.	NA	NA	NA	NA	OK*	NA
Loads calibration data in binary data format.	NA	NA	NA	NA	OK*	NA
Loads all calibration data in binary data format.	NA	NA	NA	NA	OK*	NA
Loads model dictionary data in binary data format.	NA	NA	NA	NA	OK*	NA
Loads all model dictionary data in binary data format.	NA	NA	NA	NA	OK*	NA

*: Commands that are used for the no protocol (TCP) communications only.

File Save Commands

OK: Applicable command, RST: Command with restricted execution, NA: Non-applicable command

Function	Parallel ☐ p. 46, p. 75	PLC link ☐ p. 136	EtherNet/ IP ☐ p. 113	PROFINET ☐ p. 160	No-protocol (TCP/ UDP/RS- 232C) ☐ p. 181, p. 186	No-protocol (FINS) ☐ p. 193
Saves scene data to the SD card inserted in the Touch Finder as a file.	NA	OK	OK	OK	OK	OK
Saves all scene data as a file to the SD card inserted in the Touch Finder.	NA	OK	OK	OK	OK	OK
Saves system data as a file to the SD card inserted in the Touch Finder.	NA	OK	OK	OK	OK	OK
Saves image data saved in the Sensor's memory by the logging function to the SD card inserted in the Touch Finder as ifz data.	NA	OK	OK	OK	OK	OK
Saves all image data saved in the Sensor's memory by the logging function to the SD card inserted in the Touch Finder as ifz data.	NA	OK	OK	OK	OK	OK
Saves the latest input image to the SD card inserted in the Touch Finder as ifz data.	NA	OK	OK	OK	OK	OK
Saves measurement data saved in the Sensor's memory by the logging function to the SD card inserted in the Touch Finder as csv data.	NA	OK	OK	OK	OK	OK
Saves statistical data saved in the Sensor's memory by the logging function to the SD card inserted in the Touch Finder as csv data.	NA	OK	OK	OK	OK	OK
Saves all setting data (all scene data, system data, calibration group data) for the Sensor to the SD card inserted in the Touch Finder as a backup file.	NA	OK	OK	OK	OK	OK
Saves the data for the specified calibration number as a file to the SD card inserted in the Touch Finder.	NA	OK	OK	OK	OK	OK
Saves all calibration data as a file to the SD card inserted in the Touch Finder.	NA	OK	OK	OK	OK	OK
Saves the specified number of model dictionary data as a file to the SD card inserted in the Touch Finder.	NA	OK	OK	OK	OK	OK
Saves all model dictionary data as a file to the SD card inserted in the Touch Finder.	NA	OK	OK	OK	OK	OK
Outputs scene data for the Sensor in binary data format.	NA	NA	NA	NA	OK*	NA
Outputs all scene data in binary data format.	NA	NA	NA	NA	OK*	NA
Outputs system data in binary data format.	NA	NA	NA	NA	OK*	NA
Outputs all setting data being used by the current Sensor in binary data format.	NA	NA	NA	NA	OK*	NA
Outputs image data stored in the Sensor memory in binary format.	NA	NA	NA	NA	OK*	NA
Outputs all image data stored in the Sensor memory in binary format.	NA	NA	NA	NA	OK*	NA
Outputs the calibration data in binary data format.	NA	NA	NA	NA	OK*	NA
Outputs the all calibration data in binary data format.	NA	NA	NA	NA	OK*	NA
Outputs model dictionary data in binary data format.	NA	NA	NA	NA	OK*	NA
Outputs all model dictionary data in binary data format.	NA	NA	NA	NA	OK*	NA

*: Commands that are used for the no protocol (TCP) communications only.

Command Details

Details of PLC Link, EtherNet/IP, and PROFINET Commands

Single Measurement

This command executes one measurement.

Command (PLC to Vision Sensor)

First word of command area	Bits				Contents
	12 to 15	8 to 11	4 to 7	0 to 3	
+2	0001	0000	0001	0000	Command code: 4-byte binary data
+3	0000	0000	0001	0000	

Response (Vision Sensor to PLC)

First word of response area	Bits				Contents
	12 to 15	8 to 11	4 to 7	0 to 3	
+2	0001	0000	0001	0000	Command code The command code for which the response applies is stored.
+3	0000	0000	0001	0000	
+4	0000	0000	0000	0000	Response code Command execution result 0: OK, FFFFFFFF: NG
+5	0000	0000	0000	0000	

Note

The measurement results are written to the output area if data output is set.

The measurement results are not output if data output is not set.



Setting the Data To Output Automatically after Measurements: p. 97, 124, 148

Start Continuous Measurements

This command starts continuous measurements.

Command (PLC to Vision Sensor)

First word of command area	Bits				Contents
	12 to 15	8 to 11	4 to 7	0 to 3	
+2	0001	0000	0010	0000	Command code
+3	0000	0000	0001	0000	

Response (Vision Sensor to PLC)

First word of response area	Bits				Contents
	12 to 15	8 to 11	4 to 7	0 to 3	
+2	0001	0000	0010	0000	Command code The command code for which the response applies is stored.
+3	0000	0000	0001	0000	
+4	0000	0000	0000	0000	Response code
+5	0000	0000	0000	0000	Command execution result 0: OK, FFFFFFFF: NG

Note

The measurement results are written to the output area if data output is set.
The measurement results are not output if data output is not set.



Setting the Data To Output Automatically after Measurements: p. 97, 124, 148

End Continuous Measurements

This command ends continuous measurements.

Command (PLC to Vision Sensor)

First word of command area	Bits				Contents
	12 to 15	8 to 11	4 to 7	0 to 3	
+2	0001	0000	0011	0000	Command code
+3	0000	0000	0001	0000	

Response (Vision Sensor to PLC)

First word of response area	Bits				Contents
	12 to 15	8 to 11	4 to 7	0 to 3	
+2	0001	0000	0011	0000	Command code The command code for which the response applies is stored.
+3	0000	0000	0001	0000	
+4	0000	0000	0000	0000	Response code
+5	0000	0000	0000	0000	Command execution result 0: OK, FFFFFFFF: NG

Clear Measurement Values

This command clears the measurement values.

Command (PLC to Vision Sensor)

First word of command area	Bits				Contents
	12 to 15	8 to 11	4 to 7	0 to 3	
+2	0010	0000	0001	0000	Command code
+3	0000	0000	0001	0000	

Response (Vision Sensor to PLC)

First word of response area	Bits				Contents
	12 to 15	8 to 11	4 to 7	0 to 3	
+2	0010	0000	0001	0000	Command code
+3	0000	0000	0001	0000	The command code for which the response applies is stored.
+4	0000	0000	0000	0000	Response code
+5	0000	0000	0000	0000	Command execution result 0: OK, FFFFFFFF: NG

Clear Data Output Buffer

This command clears all data from the data output buffer of the Sensor. If an error occurs in the PLC after measurement, data will remain in the data output buffer of the Sensor. This command clears the data. The command prevents deviation of the data after an error occurs. This command only clears the data output buffer of the Sensor; it does not clear the output area of the PLC.

Command (PLC to Vision Sensor)

First word of command area	Bits				Contents
	12 to 15	8 to 11	4 to 7	0 to 3	
+2	0010	0000	0010	0000	Command code
+3	0000	0000	0001	0000	

Response (Vision Sensor to PLC)

First word of response area	Bits				Contents
	12 to 15	8 to 11	4 to 7	0 to 3	
+2	0010	0000	0010	0000	Command code
+3	0000	0000	0001	0000	The command code for which the response applies is stored.
+4	0000	0000	0000	0000	Response code
+5	0000	0000	0000	0000	Command execution result 0: OK, FFFFFFFF: NG

Clear Statistical Data

This command clears the statistical data (such as the number of measurements, the number of NG overall judgments, the NG rate, and other information since the power supply was turned ON) produced by the logging function held by the Sensor.

Command (PLC to Vision Sensor)

First word of command area	Bits				Description
	12 to 15	8 to 11	4 to 7	0 to 3	
+2	0010	0000	0110	0000	Command code
+3	0000	0000	0001	0000	

Response (Vision Sensor to PLC)

First word of response area	Bits				Description
	12 to 15	8 to 11	4 to 7	0 to 3	
+2	0010	0000	0110	0000	Command code
+3	0000	0000	0001	0000	The command code for which the response applies is stored.
+4	0000	0000	0000	0000	Response code
+5	0000	0000	0000	0000	Command execution result 0: OK, FFFFFFFF: NG

Save Data in Sensor

This command saves the current system data and scene group to the Sensor.

Command (PLC to Vision Sensor)

First word of command area	Bits				Contents
	12 to 15	8 to 11	4 to 7	0 to 3	
+2	0011	0000	0001	0000	Command code
+3	0000	0000	0001	0000	

Response (Vision Sensor to PLC)

First word of response area	Bits				Contents
	12 to 15	8 to 11	4 to 7	0 to 3	
+2	0011	0000	0001	0000	Command code
+3	0000	0000	0001	0000	The command code for which the response applies is stored.
+4	0000	0000	0000	0000	Response code
+5	0000	0000	0000	0000	Command execution result 0: OK, FFFFFFFF: NG

Re-register Model (Search, Shape search II, Sensitive search, Color data)

This command re-registers the reference values for the registered inspection items based on the previously loaded image.

Command (PLC to Vision Sensor)

First word of command area	Bits				Contents
	12 to 15	8 to 11	4 to 7	0 to 3	
+2	0100	0000	0001	0000	Command code
+3	0000	0000	0001	0000	

Response (Vision Sensor to PLC)

First word of response area	Bits				Contents
	12 to 15	8 to 11	4 to 7	0 to 3	
+2	0100	0000	0001	0000	Command code The command code for which the response applies is stored.
+3	0000	0000	0001	0000	
+4	0000	0000	0000	0000	Response code
+5	0000	0000	0000	0000	Command execution result 0: OK, FFFFFFFF: NG

Teaching (All Inspection Items)

This command executes teaching for all registered inspection items.

Command (PLC to Vision Sensor)

First word of command area	Bits				Contents
	12 to 15	8 to 11	4 to 7	0 to 3	
+2	0100	0000	0010	0000	Command code
+3	0000	0000	0001	0000	

Response (Vision Sensor to PLC)

First word of response area	Bits				Contents
	12 to 15	8 to 11	4 to 7	0 to 3	
+2	0100	0000	0010	0000	Command code The command code for which the response applies is stored.
+3	0000	0000	0001	0000	
+4	0000	0000	0000	0000	Response code
+5	0000	0000	0000	0000	Command execution result 0: OK, FFFFFFFF: NG

Teaching (Filter/Position Compensation Item)

This command updates reference data for the specified image adjustment processing item (filter item/position compensation item).

For image adjustment processing items that have models, the model and reference data are updated.

Command (PLC to Vision Sensor)

First word of command area	Bits				Description
	12 to 15	8 to 11	4 to 7	0 to 3	
+2	0100	0000	0010	0001	Command code
+3	0000	0000	0001	0000	
+4	0000	0000	0000	0000	Filter item/position compensation item number (0 to 7)
+5	0000	0000	0000	0000	

Response (Vision Sensor to PLC)

First word of response area	Bits				Description
	12 to 15	8 to 11	4 to 7	0 to 3	
+2	0100	0000	0010	0001	Command code
+3	0000	0000	0001	0000	The command code for which the response applies is stored.
+4	0000	0000	0000	0000	Response code
+5	0000	0000	0000	0000	Command execution result 0: OK, FFFFFFFF: NG

Teaching (Inspection Item)

This command updates the reference data for the specified inspection item.

For inspection items that have models, the model and reference data are updated.

Command (PLC to Vision Sensor)

First word of command area	Bits				Description
	12 to 15	8 to 11	4 to 7	0 to 3	
+2	0100	0000	0010	0010	Command code
+3	0000	0000	0001	0000	
+4	0000	0000	0000	0000	Inspection item number (0 to 31)*
+5	0000	0000	0000	0000	

* Only "0" can be specified with the FQ2-S1 series.

Response (Vision Sensor to PLC)

First word of response area	Bits				Description
	12 to 15	8 to 11	4 to 7	0 to 3	
+2	0100	0000	0010	0010	Command code
+3	0000	0000	0001	0000	The command code for which the response applies is stored.
+4	0000	0000	0000	0000	Response code
+5	0000	0000	0000	0000	Command execution result 0: OK, FFFFFFFF: NG

Re-register Reference Value (Position Compensation Item)

This command re-registers the reference value for the specified position compensation item based on the previously loaded image.

Command (PLC to Vision Sensor)

First word of command area	Bits				Description
	12 to 15	8 to 11	4 to 7	0 to 3	
+2	0100	0000	0011	0001	Command code
+3	0000	0000	0001	0000	
+4	0000	0000	0000	0000	Position compensation item number (0 to 7)
+5	0000	0000	0000	0000	

Response (Vision Sensor to PLC)

First word of response area	Bits				Description
	12 to 15	8 to 11	4 to 7	0 to 3	
+2	0100	0000	0011	0001	Command code
+3	0000	0000	0001	0000	The command code for which the response applies is stored.
+4	0000	0000	0000	0000	Response code
+5	0000	0000	0000	0000	Command execution result 0: OK, FFFFFFFF: NG

Re-register Reference Value (Inspection Item)

This command re-registers the reference values for the specified inspection item based on the previously loaded image.

Command (PLC to Vision Sensor)

First word of command area	Bits				Description
	12 to 15	8 to 11	4 to 7	0 to 3	
+2	0100	0000	0011	0010	Command code
+3	0000	0000	0001	0000	
+4	0000	0000	0000	0000	Inspection item number (0 to 31)*
+5	0000	0000	0000	0000	

* Only "0" can be specified with the FQ2-S1 series.

Response (Vision Sensor to PLC)

First word of response area	Bits				Description
	12 to 15	8 to 11	4 to 7	0 to 3	
+2	0100	0000	0011	0010	Command code
+3	0000	0000	0001	0000	The command code for which the response applies is stored.
+4	0000	0000	0000	0000	Response code
+5	0000	0000	0000	0000	Command execution result 0: OK, FFFFFFFF: NG

Set Registered Image

Sets the latest image or a specified logging image as a registered image.

Registered images are saved to the following directory on the SD card or PC Tool.

\\Sensor name\\REGIMAGE*

The file name is not case sensitive. The file name extension can be omitted.

The image specified as a registered image can be loaded as a measurement image with the Acquire Registered Image command.



Acquire Registered Image: p.214

A maximum of 1000 registered images (image registration number: 0 to 999) can be set.

* For the PC Tool, the data is saved in the "\\.\My Documents\OMRON FQ\" folder.

Command (PLC to Vision Sensor)

First word of command area	Bits				Description
	12 to 15	8 to 11	4 to 7	0 to 3	
+2	1000	0000	0001	0000	Command code
+3	0000	0000	0001	0000	
+4	0000	0000	0000	0000	
+5	0000	0000	0000	0000	Registered image number (0 to 999)
+6	0000	0000	0000	0000	
+7	0000	0000	0000	0000	Specifying the image to set as a registered image 0: Latest measurement image 1: Sensor logging image
+8	0000	0000	0000	0000	Logging image number (0 to 19)*
+9	0000	0000	0000	0000	

* Only when setting the Sensor's logging images as registered images

Response (Vision Sensor to PLC)

First word of response area	Bits				Description
	12 to 15	8 to 11	4 to 7	0 to 3	
+2	1000	0000	0001	0000	Command code
+3	0000	0000	0001	0000	The command code for which the response applies is stored.
+4	0000	0000	0000	0000	Response code
+5	0000	0000	0000	0000	Command execution result 0: OK, FFFFFFFF: NG

Acquire Registered Image

This command loads a registered image saved to the SD card or PC Tool as the measurement image. The registered image is the latest image or a logging image that has been assigned a number between 0 and 999 and has been registered in advance with the Set Registered Image command.

 Set Registered Image: p.213

Command (PLC to Vision Sensor)

First word of command area	Bits				Description
	12 to 15	8 to 11	4 to 7	0 to 3	
+2	1000	0000	0010	0000	Command code
+3	0000	0000	0001	0000	
+4	0000	0000	0000	0000	Registered image number (0 to 999)
+5	0000	0000	0000	0000	

Response (Vision Sensor to PLC)

First word of response area	Bits				Description
	12 to 15	8 to 11	4 to 7	0 to 3	
+2	1000	0000	0010	0000	Command code
+3	0000	0000	0001	0000	The command code for which the response applies is stored.
+4	0000	0000	0000	0000	Response code
+5	0000	0000	0000	0000	Command execution result 0: OK, FFFFFFFF: NG

Echo

Returns as is any character string sent by an external device.

Responds in the response areas +6+7 with the data that was set in command areas +4+5.

Command (PLC to Vision Sensor)

First word of command area	Bits				Description
	12 to 15	8 to 11	4 to 7	0 to 3	
+2	1001	0000	0001	0000	Command code
+3	0000	0000	0001	0000	
+4	0000	0000	0000	0000	Any data (2 words)
+5	0000	0000	0000	0000	

Response (Vision Sensor to PLC)

First word of response area	Bits				Description
	12 to 15	8 to 11	4 to 7	0 to 3	
+2	1001	0000	0001	0000	Command code
+3	0000	0000	0001	0000	The command code for which the response applies is stored.
+4	0000	0000	0000	0000	Response code
+5	0000	0000	0000	0000	Command execution result 0: OK, FFFFFFFF: NG
+6	0000	0000	0000	0000	Response data Any data (2 words)
+7	0000	0000	0000	0000	

Reset Vision Sensor

This command restarts the Sensor.

Command (PLC to Vision Sensor)

First word of command area	Bits				Contents
	12 to 15	8 to 11	4 to 7	0 to 3	
+2	1111	0000	0001	0000	Command code
+3	0000	0000	0001	0000	

Response (Vision Sensor to PLC)

First word of response area	Bits				Contents
	12 to 15	8 to 11	4 to 7	0 to 3	

There is no response for a reset operation.

Important

If you leave the EXE signal ON when you use it to execute the Reset command, the Vision Sensor will restart repeatedly. After you execute the Reset command, turn OFF the EXE signal before the Vision Sensor restarts.

Get Scene Number

This command acquires the scene number currently being used.

Command (PLC to Vision Sensor)

First word of command area	Bits				Contents
	12 to 15	8 to 11	4 to 7	0 to 3	
+2	0001	0000	0000	0000	Command code
+3	0000	0000	0010	0000	

Response (Vision Sensor to PLC)

First word of response area	Bits				Contents
	12 to 15	8 to 11	4 to 7	0 to 3	
+2	0001	0000	0000	0000	Command code The command code for which the response applies is stored.
+3	0000	0000	0010	0000	
+4	0000	0000	0000	0000	Response code
+5	0000	0000	0000	0000	Command execution result 0: OK, FFFFFFFF: NG
+6	0000	0000	0000	0000	Response data
+7	0000	0000	0000	0000	Acquired scene number

Select Scene

Changes the scene number to be used.

Command (PLC to Vision Sensor)

First word of command area	Bits				Contents
	12 to 15	8 to 11	4 to 7	0 to 3	
+2	0001	0000	0000	0000	Command code
+3	0000	0000	0011	0000	
+4	0000	0000	0000	0000	Scene number
+5	0000	0000	0000	0000	

Response (Vision Sensor to PLC)

First word of response area	Bits				Contents
	12 to 15	8 to 11	4 to 7	0 to 3	
+2	0001	0000	0000	0000	Command code
+3	0000	0000	0011	0000	The command code for which the response applies is stored.
+4	0000	0000	0000	0000	Response code
+5	0000	0000	0000	0000	Command execution result 0: OK, FFFFFFFF: NG

Acquire Image Adjustment Item Data

This command acquires parameters and measurement values for a position compensation item or filter item.

Command (PLC to Vision Sensor)

First word of command area	Bits				Contents
	12 to 15	8 to 11	4 to 7	0 to 3	
+2	0001	0000	0001	0000	Command code
+3	0000	0000	0100	0000	
+4	0000	0000	0000	0000	Position compensation item/filter item number
+5	0000	0000	0000	0000	
+6	0000	0000	0000	0000	Data number  9-2 External Reference Parameters in Vision Sensor FQ2-S/CH Series User's Manual (Cat. No. Z337)
+7	0000	0000	0000	0000	

Response (Vision Sensor to PLC)

First word of response area	Bits				Contents
	12 to 15	8 to 11	4 to 7	0 to 3	
+2	0001	0000	0001	0000	Command code
+3	0000	0000	0100	0000	The command code for which the response applies is stored.
+4	0000	0000	0000	0000	Response code
+5	0000	0000	0000	0000	Command execution result 0: OK, FFFFFFFF: NG
+6	0000	0000	0000	0000	Acquired data (1,000 times the value)
+7	0000	0000	0000	0000	

Get Inspection Item Data

This command acquires parameters and measurement values for the specified inspection item.

Command (PLC to Vision Sensor)

First word of command area	Bits				Contents
	12 to 15	8 to 11	4 to 7	0 to 3	
+2	0001	0000	0010	0000	Command code
+3	0000	0000	0100	0000	
+4	0000	0000	0000	0000	Inspection item number
+5	0000	0000	0000	0000	
+6	0000	0000	0000	0000	Data number
+7	0000	0000	0000	0000	

Response (Vision Sensor to PLC)

First word of response area	Bits				Contents
	12 to 15	8 to 11	4 to 7	0 to 3	
+2	0001	0000	0010	0000	Command code
+3	0000	0000	0100	0000	The command code for which the response applies is stored.
+4	0000	0000	0000	0000	Response code
+5	0000	0000	0000	0000	Command execution result 0: OK, FFFFFFFF: NG
+6	0000	0000	0000	0000	Acquired data (1,000 times the value)
+7	0000	0000	0000	0000	

Acquire Camera Parameter

This command acquires the value of the specified camera parameter.

Command (PLC to Vision Sensor)

First word of command area	Bits				Description
	12 to 15	8 to 11	4 to 7	0 to 3	
+2	0001	0000	0100	0000	Command code
+3	0000	0000	0100	0000	
+4	0000	0000	0000	0000	Command parameter number*
+5	0000	0000	0000	0000	

Response (Vision Sensor to PLC)

First word of response area	Bits				Description
	12 to 15	8 to 11	4 to 7	0 to 3	
+2	0001	0000	0100	0000	Command code
+3	0000	0000	0100	0000	The command code for which the response applies is stored.
+4	0000	0000	0000	0000	Response code
+5	0000	0000	0000	0000	Command execution result 0: OK, FFFFFFFF: NG
+6	0000	0000	0000	0000	Acquired data (1,000 times the value)
+7	0000	0000	0000	0000	

* Camera parameter numbers
For details about the items, refer to the setting descriptions for each item.
Except for the no-protocol (TCP) and no-protocol (UDP), get and set value is 1000 times the value.

Camera parameter number	Item	Range	Description
1	Shutter speed	1 to 60,000 ^{*1}	Specifies the shutter speed. Specify the "n" portion of "1/n". By the camera, get and set value will change. Please refer the following.
2	Gain	0 to 64 ^{*2}	Specifies the gain. By the camera, get and set value will change. Please refer the following.
3	HDR mode	0: OFF 1: Level 1 2: Level 2 3: Level 3 4: Level 4	Turns the HDR function ON and specifies its level or turns the HDR function OFF. The HDR function suppresses lighting reflections in the image and differences in brightness between light and dark.
4	Brightness (HDR mode)	1 to 100	Specifies the brightness level of the image. This setting is enabled only in HDR mode.
5	X coordinate of the partial input start point	The following ranges depending on the processing resolution of the Sensor's internal camera. ^{*3} 0.3M: Cannot be used. NG is issued in the response. 0.8M: 176 to 1,088 1.3M: 0 to 1,264	Reduces the range of the image to input. Specify the X and Y coordinates of the start point and end point.
6	Y coordinate of the partial input start point	The following ranges depending on the processing resolution of the Sensor's internal camera. ^{*3} 0.3M: 0 to 472 0.8M: 98 to 918 1.3M: 0 to 1,016	
7	X coordinate of the partial input end point	The following ranges depending on the processing resolution of the Sensor's internal camera. ^{*3} 0.3M: Cannot be used. NG is issued in the response. 0.8M: 191 to 1,103 1.3M: 15 to 1,016	

Camera parameter number	Item	Range	Description
8	Y coordinate of the partial input end point	The following ranges depending on the processing resolution of the Sensor's internal camera.*3 0.3M: 7 to 479 0.8M: 105 to 925 1.3M: 7 to 1,023	Reduces the range of the image to input. Specify the X and Y coordinates of the start point and end point.
9	Lighting status	0: Lighting OFF 1: Lighting ON	Specifies the lighting status of the built-in lighting for Sensors with Built-in Lighting.
10	White balance R scaling	0.001 to 7.999	
11	White balance G scaling	0.001 to 7.999	
12	White balance B scaling	0.001 to 7.999	
257	Trigger delay	0 to 163,830	Specifies the time until the camera shutter opens after the trigger condition is satisfied. (Unit: μ sec)

*1 The value about the shutter speed is the following.

Model	Range
FQ2-S3□□-13 FQ2-S3□□-13M FQ2-S4□□-13 FQ2-S4□□-13M	1/1 to 1/4,155
FQ2-S3□□□□-08 FQ2-S3□□□□-08M FQ2-S4□□□□-08 FQ2-S4□□□□-08M	1/1 to 1/4,155 (Built-in lighting off) 1/250 to 1/60,000 (Built-in lighting on)
FQ2-S1□□□□□ FQ2-S2□□□□□ FQ2-S4□□□□□ FQ2-S4□□□□□-M FQ2-CH1□□□□□-M	1/1 to 1/50,000 (Built-in lighting off) 1/250 to 1/50,000 (Built-in lighting on)

*2 The value about the gain is the following.

Model	Range
FQ2-S3□□□□-08 FQ2-S3□□□□-08M FQ2-S3□-13 FQ2-S3□-13M FQ2-S4□□□□-08 FQ2-S4□□□□-08M FQ2-S4□-13 FQ2-S4□-13M	0 to 10
FQ2-S1□□□□□ FQ2-S2□□□□□ FQ2-S4□□□□□ FQ2-S4□□□□□-M FQ2-CH1□□□□□-M	16 to 64

*3 The processing resolution of the camera in the FQ2 Sensor is as follows.

Processing resolution	FQ2 model	Remarks
0.3M	FQ2-S1□□□□□□ FQ2-S2□□□□□□ FQ2-S4□□□□□□ FQ2-S4□□□□□□-M FQ2-CH1□□□□□□-M	Built-in Lighting types that have a processing resolution of 752x480.
0.8M	FQ2-S3□□□□□□-08 FQ2-S3□□□□□□-08M FQ2-S4□□□□□□-08 FQ2-S4□□□□□□-08M	Built-in Lighting types that have a processing resolution of 928x828.
1.3M	FQ2-S3□-13 FQ2-S3□-13M FQ2-S4□-13 FQ2-S4□-13M	C-mount types that have a processing resolution of 1280x1024.

Get Software Version Information

Acquires the Sensor's software version.

Command (PLC to Vision Sensor)

First word of command area	Bits				Contents
	12 to 15	8 to 11	4 to 7	0 to 3	
+2	0011	0000	0000	0000	Command code
+3	0000	0000	0100	0000	

Response (Vision Sensor to PLC)

First word of response area	Bits				Contents
	12 to 15	8 to 11	4 to 7	0 to 3	
+2	0011	0000	0000	0000	Command code
+3	0000	0000	0100	0000	The command code for which the response applies is stored.
+4	0000	0000	0000	0000	Response code
+5	0000	0000	0000	0000	Command execution result 0: OK, FFFFFFFF: NG
+6	0000	0000	0000	0000	Response data
+7	0000	0000	0000	0000	Software version (1,000 times the value)

Acquire System Data

This command acquires the value set for the specified system data.

Command (PLC to Vision Sensor)

First word of command area	Bits				Description
	12 to 15	8 to 11	4 to 7	0 to 3	
+2	0100	0000	0001	0000	Command code
+3	0000	0000	0100	0000	
+4	0000	0000	0000	0000	Command parameter number*
+5	0000	0000	0000	0000	

Response (Vision Sensor to PLC)

First word of response area	Bits				Description
	12 to 15	8 to 11	4 to 7	0 to 3	
+2	0100	0000	0001	0000	Command code
+3	0000	0000	0100	0000	The command code for which the response applies is stored.
+4	0000	0000	0000	0000	Response code
+5	0000	0000	0000	0000	Command execution result 0: OK, FFFFFFFF: NG
+6	0000	0000	0000	0000	Acquired data (1,000 times the value)
+7	0000	0000	0000	0000	

* System data numbers and details
For details about the items, refer to the setting descriptions for each item.
Except for the no-protocol (TCP) and no-protocol (UDP), get and set value is 1000 times the value.

System data number	Type	Item	Data size	Range	Description
1	Configuration	Startup scene number	4	0 to 7: For single-function models 0 to 31: For other models	Specifies the scene number at startup.
2	Configuration	Startup scene control	4	0: Start with number when saved 1: Start with specified number	Specifies whether to start with the scene number when data was saved or to start with the specified scene number.
101	Camera control	Trigger delay	4	0 to 163,830	Specifies the time (μ s) to shift when to capture the image with a trigger delay.
105	Measurement control	BUSY output condition	4	0: Measurement end 1: Data logging end 2: Image logging end 3: Until result display end	Defines the interval to turn on the BUSY signal when performing measurements.
102	Logging control	Image data	4	0: None 1: All 2: NG only	Specifies the logging condition for measurement image data.

System data number	Type	Item	Data size	Range	Description
103	Logging control	Measurement data	4	0: None 1: All 2: NG only	Specifies the logging condition for measurement data for each inspection item.
104	Logging control	Statistical data	4	0: None 1: Yes	Specifies whether or not to record statistical data (such as the number of measurements, number of NG judgments).
106	Parallel control	OR output	4	0: OK: ON 1: NG: ON	Specifies the polarity when the OUT0 output signal is ON.
107	Parallel control	Output delay	4	0 to 1,000	Specifies the ON delay time (ms) from when the measurement processing completes until output when using one-shot output.
108	Parallel control	Judgment output mode	4	0: Level output 1: One-shot output	Specifies whether output is one-shot output or level output.
109	Parallel control	One-shot output time	4	1 to 1,000	Specifies the ON output time (ms) when using one-shot output.
110	Parallel control	OUT0 polarity	4	0: Positive 1: Negative	Specifies the polarity for the OUT0 output signal (default assignment: BUSY).
111	Parallel control	OUT1 polarity	4	0: Positive 1: Negative	Specifies the polarity for the OUT1 output signal (default assignment: OR).
112	Parallel control	OUT2 polarity	4	0: Positive 1: Negative	Specifies the polarity for the OUT2 output signal (default assignment: ERROR).
113	Parallel control	OUT0 signal assignment	4	0: Control signal 1 to 32: OR0 to 31 1001 to 1032: Expression 1 to 32 2001: OR (overall judgement) 2002: BUSY 2003: ERROR 2004: READY 2005: RUN 2006: STG	Specifies whether to use the signal as a control signal or to use the signal as a judgment output (OR individual output signal) for inspection items.

System data number	Type	Item	Data size	Range	Description
114	Parallel control	OUT1 signal assignment	4	0: Control signal 1 to 32: OR0 to 31 1001 to 1032: Expression 1 to 32 2001: OR (overall judgement) 2002: BUSY 2003: ERROR 2004: READY 2005: RUN 2006: STG	Specifies whether to use the signal as a control signal or to use the signal as a judgment output (OR individual output signal) for inspection items.
115	Parallel control	OUT2 signal assignment	4	0: Control signal 1 to 32: OR0 to 31 1001 to 1032: Expression 1 to 32 2001: OR (overall judgement) 2002: BUSY 2003: ERROR 2004: READY 2005: RUN 2006: STG	Specifies whether to use the signal as a control signal or to use the signal as a judgment output (OR individual output signal) for inspection items.
116	Parallel control	Input mode	4	0: Standard mode (scene changing only) 1: Expanded mode	Specifies whether or not to enable functions other than scene changing with external parallel commands.
117	Parallel control	LED BUSY	4	0: BUSY 1: RUN	Specifies whether to synchronize the BUSY indicator with BUSY or with RUN.
3	Retry function	Retry mode	4	0: None 1: Normal retry 2: Exposure retry 3: Scene retry 4: Trigger retry	Specifies the retry mode.
4	Retry function	Switch order (scene switching)	4	0: Auto 1: Fixed	Specifies the scene switching order for scene changing retries.
5	Retry function	Switch order (target scene)	4	-1: none (termination) 0 to 31: Target scene number	Specifies the target scene number of the scene switching
6	Retry function	Timeout time	4	100 to 9,999 (msec)	Scene retry timeout time
201	Parallel Interface Sensor Data Unit	OR output	4	0: OK: ON 1: NG: ON	Specifies the polarity when the OUT0 output signal is ON. Overall judgements are supported.
202	Parallel Interface Sensor Data Unit	Judgment output mode	4	0: Level output 1: One-shot output	Specifies whether output is one-shot output or level output.
203	Parallel Interface Sensor Data Unit	OR output delay time	4	0 to 10,000	Specifies the ON delay time (x0.1 ms) until outputting the signal.

System data number	Type	Item	Data size	Range	Description
204	Parallel Interface Sensor Data Unit	OR one-shot output time	4	1 to 10,000	Specifies the output time (x0.1 ms) when using one-shot output.
205	Parallel Interface Sensor Data Unit	Output control	4	0: No handshake 1: Handshake 2: Sync output	Specifies the control method for output timing.
206	Parallel Interface Sensor Data Unit	Output period	4	20 to 50,000	Specifies the period (x0.1 ms) for outputting measurement results.
207	Parallel Interface Sensor Data Unit	GATE ON delay	4	10 to 10,000	Specifies the ON delay time (x0.1 ms) from when outputting the results to the parallel interface until outputting the GATE signal.
208	Parallel Interface Sensor Data Unit	Output time	4	10 to 10,000	Specifies the time (x0.1 ms) the GATE signal output is ON.
209	Parallel Interface Sensor Data Unit	Timeout	4	5 to 1,200	Specifies the timeout time (x0.1 s) when using handshaking.
210	Parallel Interface Sensor Data Unit	Number of delay	4	1 to 15	Specifies the number of delays when using synchronized output.
211	Parallel Interface Sensor Data Unit	ACK signal ON period	4	1 to 10,000	Specifies the ACK signal ON output time (x0.1 ms) when outputting the ACK signal.
251	RS-232C Interface Sensor Data Unit	OR output	4	0: OK: ON 1: NG: ON	Specifies the polarity when the OUT0 output signal is ON. Overall judgements are supported.
252	RS-232C Interface Sensor Data Unit	Judgment output mode	4	0: Level output 1: One-shot output	Specifies whether output is one-shot output or level output.
253	RS-232C Interface Sensor Data Unit	OR output delay time	4	0 to 10,000	Specifies the ON delay time (x0.1 ms) until outputting the signal.
254	RS-232C Interface Sensor Data Unit	OR one-shot output time	4	1 to 10,000	Specifies the output time (x0.1 ms) when using one-shot output.

System data number	Type	Item	Data size	Range	Description
255	RS-232C Interface Sensor Data Unit	All OUT signals polarity	4	0: Positive 1: Negative	Specifies the polarity for all output signals.
256	RS-232C Interface Sensor Data Unit	Parallel command mode	4	0: Standard mode 1: Expanded mode	Defines the parallel command mode.
257	RS-232C Interface Sensor Data Unit	ACK signal ON period	4	1 to 10,000	Specifies the ACK signal ON output time (x0.1 ms) when outputting the ACK signal.

Acquire Terminal Offset Data

This command acquires the terminal offset data that is added to the IN0 to IN4 command parameters when executing parallel commands

After the Set Terminal Offset command is executed, the response code is OK when this command is executed. If no value has been set with the Set Terminal Offset command, OK "0" is returned as response code and "0000" is returned for the terminal offset value.

 Set Terminal Offset Data: p.235

Command (PLC to Vision Sensor)

First word of command area	Bits				Description
	12 to 15	8 to 11	4 to 7	0 to 3	
+2	0100	0000	0110	0000	Command code
+3	0000	0000	0100	0000	

Response (Vision Sensor to PLC)

First word of response area	Bits				Description
	12 to 15	8 to 11	4 to 7	0 to 3	
+2	0100	0000	0110	0000	Command code The command code for which the response applies is stored.
+3	0000	0000	0100	0000	
+4	0000	0000	0000	0000	Response code
+5	0000	0000	0000	0000	Command execution result 0: OK, FFFFFFFF: NG
+6	0000	0000	0000	0000	Terminal offset value
+7	0000	0000	0000	0000	Value added to the IN0 to IN4 command parameters when executing parallel commands

Acquire Statistical Data

Acquires the statistical data (such as the number of measurements, number of NG overall judgments, and other information, since the power supply was turned ON) held by the Sensor.

The following types of statistical data are available. Specify the data to be read from these types with this command.

- Number of measurements since the power supply was turned ON
- Number of OK overall judgments
- NG rate
- Number of NG judgments since the power supply was turned ON
- OK rate

Command (PLC to Vision Sensor)

First word of command area	Bits				Description
	12 to 15	8 to 11	4 to 7	0 to 3	
+2	0110	0000	0001	0000	Command code
+3	0000	0000	0100	0000	
+4	0000	0000	0000	0000	Type of statistical data to be acquired 1: Number of measurements 2: Number of NG judgments 3: NG rate 4: Number of OK judgments 5: OK rate
+5	0000	0000	0000	0000	

Response (Vision Sensor to PLC)

First word of response area	Bits				Description
	12 to 15	8 to 11	4 to 7	0 to 3	
+2	0110	0000	0001	0000	Command code
+3	0000	0000	0100	0000	The command code for which the response applies is stored.
+4	0000	0000	0000	0000	Response code
+5	0000	0000	0000	0000	Command execution result 0: OK, FFFFFFFF: NG
+6	0000	0000	0000	0000	Value of acquired statistical data
+7	0000	0000	0000	0000	The acquired value has been multiplied by 1,000.

Get Latest Error Information

Acquires the Sensor's most recent error code.

Command (PLC to Vision Sensor)

First word of command area	Bits				Contents
	12 to 15	8 to 11	4 to 7	0 to 3	
+2	0101	0000	0000	0000	Command code
+3	0000	0000	0010	0000	

Response (Vision Sensor to PLC)

First word of response area	Bits				Contents
	12 to 15	8 to 11	4 to 7	0 to 3	
+2	0101	0000	0000	0000	Command code
+3	0000	0000	0010	0000	The command code for which the response applies is stored.
+4	0000	0000	0000	0000	Response code
+5	0000	0000	0000	0000	Command execution result 0: OK, FFFFFFFF: NG
+6	0000	0000	0000	0000	Response data
+7	0000	0000	0000	0000	Latest error code  Section 9 Appendices in Vision Sensor FQ2-S/CH Series User's Manual (Cat. No. Z337)

Acquire Communication Input Status

This command acquires the input status (allowed/prohibited) for the communications protocol set with the Set Communication Input Status command.

Command (PLC to Vision Sensor)

First word of command area	Bits				Description
	12 to 15	8 to 11	4 to 7	0 to 3	
+2	0111	0000	0001	0000	Command code
+3	0000	0000	0010	0000	
+4	0000	0000	0000	0000	Communications protocol type to be acquired*
+5	0000	0000	0000	0000	0: No protocol (TCP, UDP, FINS) 1: No protocol (RS-232C) 2: Parallel I/O 3: Fieldbus 5: PLC link

Response (Vision Sensor to PLC)

First word of response area	Bits				Description
	12 to 15	8 to 11	4 to 7	0 to 3	
+2	0111	0000	0001	0000	Command code
+3	0000	0000	0010	0000	The command code for which the response applies is stored.
+4	0000	0000	0000	0000	Response code
+5	0000	0000	0000	0000	Command execution result 0: OK, FFFFFFFF: NG
+6	0000	0000	0000	0000	Acquired communications protocol status
+7	0000	0000	0000	0000	0: Input prohibited status 1: Input allowed status

* The communications protocol types are defined by the following numbers.

Communications protocol No.	Communications type		Remarks
0	No protocol (Ethernet)	No-protocol (UDP)	
		No-protocol (TCP)	
		No-protocol (FINS/TCP)	
1	No protocol (RS-232C)		
2	Parallel I/O		
3	Fieldbus	EtherNet/IP	
		PROFINET	
4	Reserved		Results in an error when specified.
5	PLC link	PLC Link (SYSMAC)	
		PLC Link (MELSEC)	

Acquire Communication Output Status

This command acquires the output status (allowed/prohibited) for all of the communications protocol set with the Set Communication Output Status command.

Command (PLC to Vision Sensor)

First word of command area	Bits				Description
	12 to 15	8 to 11	4 to 7	0 to 3	
+2	0111	0000	0010	0000	Command code
+3	0000	0000	0010	0000	

Response (Vision Sensor to PLC)

First word of response area	Bits				Description
	12 to 15	8 to 11	4 to 7	0 to 3	
+2	0111	0000	0010	0000	Command code
+3	0000	0000	0010	0000	The command code for which the response applies is stored.
+4	0000	0000	0000	0000	Response code
+5	0000	0000	0000	0000	Command execution result 0: OK, FFFFFFFF: NG
+6	0000	0000	0000	0000	Acquired communications protocol status
+7	0000	0000	0000	0000	0: Output prohibited status 1: Output allowed status

Acquire Terminal Status

Acquires the ON/OFF status of the input signal for the specified parallel I/O terminal.

Command (PLC to Vision Sensor)

First word of command area	Bits				Description
	12 to 15	8 to 11	4 to 7	0 to 3	
+2	1000	0000	0001	0000	Command code
+3	0000	0000	0010	0000	
+4	0000	0000	0000	0000	Terminal type <ul style="list-style-type: none"> • Sensor's standard parallel communications 0: TRIG 2: IN0 to IN5 • Parallel Interface Sensor Data Unit 0: TRIG 1: DSA 2: IN0 to IN7 13: RESET • RS-232C Interface Sensor Data Unit 0: TRIG 2: IN0 to IN5 13: RESET
+5	0000	0000	0000	0000	
+6	0000	0000	0000	0000	Terminal number Specifies the terminal number to get the status of the pin. Terminal-type case of IN0 to IN5 0: IN0 to 5: IN5 Terminal-type case of IN0 to IN7 0: IN0 to 7: IN7 In the cases other than the above, Specify 0.
+7	0000	0000	0000	0000	

Response (Vision Sensor to PLC)

First word of response area	Bits				Description
	12 to 15	8 to 11	4 to 7	0 to 3	
+2	1000	0000	0001	0000	Command code
+3	0000	0000	0010	0000	The command code for which the response applies is stored.
+4	0000	0000	0000	0000	Response code
+5	0000	0000	0000	0000	Command execution result 0: OK, FFFFFFFF: NG
+6	0000	0000	0000	0000	Acquired terminal status 0: OFF 1: ON
+7	0000	0000	0000	0000	

Batch Acquire Terminal Status

Batch acquires the ON/OFF status for the all parallel I/O input terminals other than the IN terminals.

Command (PLC to Vision Sensor)

First word of command area	Bits				Description
	12 to 15	8 to 11	4 to 7	0 to 3	
+2	1000	0000	0010	0000	Command code
+3	0000	0000	0010	0000	

Response (Vision Sensor to PLC)

First word of response area	Bits				Description
	12 to 15	8 to 11	4 to 7	0 to 3	
+2	1000	0000	0010	0000	Command code
+3	0000	0000	0010	0000	The command code for which the response applies is stored.
+4	0000	0000	0000	0000	Response code
+5	0000	0000	0000	0000	Command execution result 0: OK, FFFFFFFF: NG
+6	0000	0000	0000	0000	Terminal status (ON: 1, OFF: 0)
+7	0000	0000	0000	0000	BIT0: TRIG BIT1: DSA BIT4: RESET

Batch Acquire IN Terminal Status

Batch acquires the ON/OFF status for the IN terminals.

Command (PLC to Vision Sensor)

First word of command area	Bits				Description
	12 to 15	8 to 11	4 to 7	0 to 3	
+2	1000	0000	0011	0000	Command code
+3	0000	0000	0010	0000	

Response (Vision Sensor to PLC)

First word of response area	Bits				Description
	12 to 15	8 to 11	4 to 7	0 to 3	
+2	1000	0000	0011	0000	Command code
+3	0000	0000	0010	0000	The command code for which the response applies is stored.
+4	0000	0000	0000	0000	Response code
+5	0000	0000	0000	0000	Command execution result 0: OK, FFFFFFFF: NG
+6	0000	0000	0000	0000	Terminal status (ON: 1, OFF: 0)
+7	0000	0000	0000	0000	BIT0: IN0 BIT1: IN1 BIT2: IN2 BIT3: IN3 BIT4: IN4 BIT5: IN5 BIT6: IN6 BIT7: IN7

Acquire Execution Mode

Acquires the FQ2 execution status (execution mode).

Command (PLC to Vision Sensor)

First word of command area	Bits				Description
	12 to 15	8 to 11	4 to 7	0 to 3	
+2	1111	0000	0000	0000	Command code
+3	0000	0000	0010	0000	

Response (Vision Sensor to PLC)

First word of response area	Bits				Description
	12 to 15	8 to 11	4 to 7	0 to 3	
+2	1111	0000	0000	0000	Command code
+3	0000	0000	0010	0000	The command code for which the response applies is stored.
+4	0000	0000	0000	0000	Response code
+5	0000	0000	0000	0000	Command execution result 0: OK, FFFFFFFF: NG
+6	0000	0000	0000	0000	Execution mode*
+7	0000	0000	0000	0000	1: Run mode 2: Stop mode 10: Adjust mode 11: IO monitor setup mode

- * The execution mode is classified into the following modes depending on the FQ2 execution status.
- Run mode: The mode to run actual measurements. I/O is possible with external devices such as a PLC.
 - Stop mode: This mode is for monitoring/controlling the output status of the parallel signals through communication commands only. Therefore, I/O that is unrelated to parallel terminal control is not possible.
 - Input: Parallel signal input is not possible. Command input is not possible. (However, the terminal status monitor, setting commands can be used)
 - Output: Parallel signal output is possible. Data output is not possible.
 - Adjust mode: The status where Touch Finder is connected and the Setup display is displayed. This mode is for configuring settings and making adjustments, so measurement processing, I/O signals from external devices, and command input are not possible.
 - IO monitor setup mode: The status where Touch Finder is connected and the IO monitor in the Setup display is displayed.

Set Preprocessing Item Data for Image Adjustment

Sets parameters for a position compensation item or filter item.

Command (PLC to Vision Sensor)

First word of command area	Bits				Contents
	12 to 15	8 to 11	4 to 7	0 to 3	
+2	0001	0000	0001	0000	Command code
+3	0000	0000	0101	0000	
+4	0000	0000	0000	0000	Position compensation item/filter item number
+5	0000	0000	0000	0000	
+6	0000	0000	0000	0000	Data number
+7	0000	0000	0000	0000	
+8	0000	0000	0000	0000	Setting data (1,000 times the value)
+9	0000	0000	0000	0000	

Response (Vision Sensor to PLC)

First word of response area	Bits				Contents
	12 to 15	8 to 11	4 to 7	0 to 3	
+2	0001	0000	0001	0000	Command code
+3	0000	0000	0101	0000	The command code for which the response applies is stored.
+4	0000	0000	0000	0000	Response code
+5	0000	0000	0000	0000	Command execution result 0: OK, FFFFFFFF: NG

Set Inspection Item Data

Sets parameters for the specified inspection item.

Command (PLC to Vision Sensor)

First word of command area	Bits				Contents
	12 to 15	8 to 11	4 to 7	0 to 3	
+2	0001	0000	0010	0000	Command code
+3	0000	0000	0101	0000	
+4	0000	0000	0000	0000	Inspection item number
+5	0000	0000	0000	0000	
+6	0000	0000	0000	0000	Data number
+7	0000	0000	0000	0000	
+8	0000	0000	0000	0000	Setting data (1,000 times the value)
+9	0000	0000	0000	0000	

Response (Vision Sensor to PLC)

First word of response area	Bits				Contents
	12 to 15	8 to 11	4 to 7	0 to 3	
+2	0001	0000	0010	0000	Command code
+3	0000	0000	0101	0000	The command code for which the response applies is stored.
+4	0000	0000	0000	0000	Response code
+5	0000	0000	0000	0000	Command execution result 0: OK, FFFFFFFF: NG

Set Camera Parameter

Sets the value for the specified camera parameter.

 Camera parameter numbers: p. 219

Command (PLC to Vision Sensor)

First word of command area	Bits				Description
	12 to 15	8 to 11	4 to 7	0 to 3	
+2	0001	0000	0100	0000	Command code
+3	0000	0000	0101	0000	
+4	0000	0000	0000	0000	Camera parameter number
+5	0000	0000	0000	0000	
+6	0000	0000	0000	0000	Setting data (1,000 times the value)
+7	0000	0000	0000	0000	

Response (Vision Sensor to PLC)

First word of response area	Bits				Description
	12 to 15	8 to 11	4 to 7	0 to 3	
+2	0001	0000	0100	0000	Command code
+3	0000	0000	0101	0000	The command code for which the response applies is stored.
+4	0000	0000	0000	0000	Response code
+5	0000	0000	0000	0000	Command execution result 0: OK, FFFFFFFF: NG

Set System Data

Sets the value to the specified system data.

 System data numbers and details: p. 222

Command (PLC to Vision Sensor)

First word of command area	Bits				Description
	12 to 15	8 to 11	4 to 7	0 to 3	
+2	0100	0000	0001	0000	Command code
+3	0000	0000	0101	0000	
+4	0000	0000	0000	0000	System data number*
+5	0000	0000	0000	0000	
+6	0000	0000	0000	0000	Setting data (1,000 times the value)
+7	0000	0000	0000	0000	

Response (Vision Sensor to PLC)

First word of response area	Bits				Description
	12 to 15	8 to 11	4 to 7	0 to 3	
+2	0100	0000	0001	0000	Command code
+3	0000	0000	0101	0000	The command code for which the response applies is stored.
+4	0000	0000	0000	0000	Response code
+5	0000	0000	0000	0000	Command execution result 0: OK, FFFFFFFF: NG

Set Terminal Offset Data

This command sets the value of the terminal offset data that is added to the IN0 to IN4 command parameters when executing parallel commands.

When using parallel command scene changing, you can change the scenes to change to by changing the Set Terminal Offset Data value.

Command (PLC to Vision Sensor)

First word of command area	Bits				Description
	12 to 15	8 to 11	4 to 7	0 to 3	
+2	0100	0000	0110	0000	Command code
+3	0000	0000	0101	0000	
+4	0000	0000	0000	0000	Terminal offset value
+5	0000	0000	0000	0000	Value added to the IN0 to IN4 command parameters when executing parallel commands

Response (Vision Sensor to PLC)

First word of response area	Bits				Description
	12 to 15	8 to 11	4 to 7	0 to 3	
+2	0100	0000	0110	0000	Command code
+3	0000	0000	0101	0000	The command code for which the response applies is stored.
+4	0000	0000	0000	0000	Response code
+5	0000	0000	0000	0000	Command execution result 0: OK, FFFFFFFF: NG

Set Communication Input Status

This command sets the input status (allowed/prohibited) of the communications port for the specified communications protocol.

Communications protocols with the input status set to prohibited will no longer receive communications after being set as such.

However, for inputs related to hardware (parallel STEP signal and DSA signal), this setting is not applicable.

Command (PLC to Vision Sensor)

First word of command area	Bits				Description
	12 to 15	8 to 11	4 to 7	0 to 3	
+2	0111	0000	0001	0000	Command code
+3	0000	0000	0011	0000	
+4	0000	0000	0000	0000	Communications protocol type to be set*
+5	0000	0000	0000	0000	0: No protocol (TCP, UDP, FINS) 1: No protocol (RS-232C) 2: Parallel I/O 3: Fieldbus 5: PLC link
+6	0000	0000	0000	0000	Communications protocol status to be set
+7	0000	0000	0000	0000	0: Input prohibited status 1: Input allowed status

Response (Vision Sensor to PLC)

First word of response area	Bits				Description
	12 to 15	8 to 11	4 to 7	0 to 3	
+2	0111	0000	0001	0000	Command code
+3	0000	0000	0011	0000	The command code for which the response applies is stored.
+4	0000	0000	0000	0000	Response code
+5	0000	0000	0000	0000	Command execution result 0: OK, FFFFFFFF: NG

* The communications protocol types are defined by the following numbers.

Communications protocol No.	Communications type		Remarks
0	No protocol (Ethernet)	No-protocol (UDP)	
		No-protocol (TCP)	
1	No protocol (RS-232C)		
2	Parallel I/O		
3	Fieldbus	EtherNet/IP	
		PROFINET	
4	Reserved		Results in an error when specified.
5	PLC link	PLC Link (SYSMAC)	
		PLC Link (MELSEC)	

Set Communication Output Status

This command sets the output status (allowed/prohibited) of the communications port for all the communications protocol.

Communications protocols with the output status set to prohibited will no longer output signals after being set as such.

Command (PLC to Vision Sensor)

First word of command area	Bits				Description
	12 to 15	8 to 11	4 to 7	0 to 3	
+2	0111	0000	0010	0000	Command code
+3	0000	0000	0011	0000	
+4	0000	0000	0000	0000	Communications protocol status to be set 0: Output prohibited status 1: Output allowed status
+5	0000	0000	0000	0000	

Response (Vision Sensor to PLC)

First word of response area	Bits				Description
	12 to 15	8 to 11	4 to 7	0 to 3	
+2	0111	0000	0010	0000	Command code
+3	0000	0000	0011	0000	The command code for which the response applies is stored.
+4	0000	0000	0000	0000	Response code
+5	0000	0000	0000	0000	Command execution result 0: OK, FFFFFFFF: NG

Set Terminal Status

This command sets the output signal ON/OFF status for the specified parallel I/O terminal.

Note

When turning the parallel terminals ON or OFF with this command, there are terminals that cannot be controlled if the FQ2 execution mode is not set to stop mode. In this case, first change the FQ2 execution mode to stop mode with the Set Execution Mode command, and then execute this command.



Set Execution Mode: p.241

Command (PLC to Vision Sensor)

First word of command area	Bits				Description
	12 to 15	8 to 11	4 to 7	0 to 3	
+2	1000	0000	0001	0000	Command code
+3	0000	0000	0011	0000	
+4	0000	0000	0000	0000	Terminal type
+5	0000	0000	0000	0000	<ul style="list-style-type: none"> • Sensor's standard parallel communications 4: ERROR 5: BUSY 6: OR • Parallel Interface Sensor Data Unit 3: RUN 4: ERROR 5: BUSY 6: OR* 7: GATE* 9: D0 to D15* 10: STGOUT* 11: SHTOUT* 12: ACK* • RS-232C Interface Sensor Data Unit 3: RUN 4: ERROR 5: BUSY 6: OR* 10: STGOUT* 11: SHTOUT* 12: ACK*
+6	0000	0000	0000	0000	Terminal number
+7	0000	0000	0000	0000	Specifies the terminal number to get the status of the pin. Terminal-type case of D0 to D15 0: D0 to 15: IN5 In the cases other than the above, Specify 0.
+8	0000	0000	0000	0000	Terminal status
+9	0000	0000	0000	0000	0: OFF 1: ON

* These terminals status can only be set when the FQ2 execution mode is stop mode.

Response (Vision Sensor to PLC)

First word of response area	Bits				Description
	12 to 15	8 to 11	4 to 7	0 to 3	
+2	1000	0000	0001	0000	Command code
+3	0000	0000	0011	0000	The command code for which the response applies is stored.
+4	0000	0000	0000	0000	Response code
+5	0000	0000	0000	0000	Command execution result 0: OK, FFFFFFFF: NG

Batch Set Terminal Status

Batch sets the ON/OFF status for the all parallel I/O output terminals other than the D terminals (D0 to D15).

Important

- Before executing this command, change the FQ2 execution mode to stop mode with the Set Execution Mode command.
- If the FQ2 is not in stop mode, some parallel terminals cannot be turned ON or OFF with this command.

 Set Execution Mode: p.241

Command (PLC to Vision Sensor)

First word of command area	Bits				Description
	12 to 15	8 to 11	4 to 7	0 to 3	
+2	1000	0000	0010	0000	Command code
+3	0000	0000	0011	0000	
+4	0000	0000	0000	0000	Terminal status (ON: 1, OFF: 0)
+5	0000	0000	0000	0000	<ul style="list-style-type: none"> • Sensor's standard parallel communications BIT1: ERROR BIT2: BUSY BIT3: OR • Parallel Interface Sensor Data Unit BIT0: RUN BIT1: ERROR BIT2: BUSY BIT3: OR[*] BIT5: GATE[*] BIT9: STGOUT[*] BIT11: SHTOUT[*] BIT13: ACK[*] • RS-232C Interface Sensor Data Unit BIT0: RUN BIT1: ERROR BIT2: BUSY BIT3: OR[*] BIT9: STGOUT[*] BIT11: SHTOUT[*] BIT13: ACK[*]

* These terminals status can only be set when the FQ2 execution mode is stop mode.

Response (Vision Sensor to PLC)

First word of response area	Bits				Description
	12 to 15	8 to 11	4 to 7	0 to 3	
+2	1000	0000	0010	0000	Command code
+3	0000	0000	0011	0000	The command code for which the response applies is stored.
+4	0000	0000	0000	0000	Response code
+5	0000	0000	0000	0000	Command execution result 0: OK, FFFFFFFF: NG

Batch Set D Terminal Status

Batch sets the ON/OFF status for the D terminals (D0 to D15).

Important

Before executing this command, change the FQ2 execution mode to stop mode with the Set Execution Mode command.

 Set Execution Mode: p.241

Command (PLC to Vision Sensor)

First word of command area	Bits				Description
	12 to 15	8 to 11	4 to 7	0 to 3	
+2	1000	0000	0011	0000	Command code
+3	0000	0000	0011	0000	
+4	0000	0000	0000	0000	Terminal status (ON: 1, OFF: 0) BIT0: D0 BIT1: D1 BIT2: D2 BIT3: D3 BIT4: D4 BIT5: D5 BIT6: D6 BIT7: D7 BIT8: D8 BIT9: D9 BIT10: D10 BIT11: D11 BIT12: D12 BIT13: D13 BIT14: D14 BIT15: D15
+5	0000	0000	0000	0000	

Response (Vision Sensor to PLC)

First word of response area	Bits				Description
	12 to 15	8 to 11	4 to 7	0 to 3	
+2	1000	0000	0011	0000	Command code
+3	0000	0000	0011	0000	The command code for which the response applies is stored.
+4	0000	0000	0000	0000	Response code
+5	0000	0000	0000	0000	Command execution result 0: OK, FFFFFFFF: NG

Set Execution Mode

Sets the FQ2 execution status (execution mode).

Note

When using commands (Set Terminal Status/Batch Set Terminal Status/Batch Set DO Status) to control the ON/OFF status of the parallel I/O terminals with communication commands, change the FQ2 to stop mode with this command.

Command (PLC to Vision Sensor)

First word of command area	Bits				Description
	12 to 15	8 to 11	4 to 7	0 to 3	
+2	1111	0000	0000	0000	Command code
+3	0000	0000	0010	0000	

Response (Vision Sensor to PLC)

First word of response area	Bits				Description
	12 to 15	8 to 11	4 to 7	0 to 3	
+2	1111	0000	0000	0000	Command code
+3	0000	0000	0010	0000	The command code for which the response applies is stored.
+4	0000	0000	0000	0000	Response code
+5	0000	0000	0000	0000	Command execution result 0: OK, FFFFFFFF: NG
+6	0000	0000	0000	0000	Execution mode
+7	0000	0000	0000	0000	1: Run mode 2: Stop mode

* The execution mode is classified into the following modes depending on the FQ2 execution status.

- Run mode: The mode to run actual measurements. I/O is possible with external devices such as a PLC.
- Stop mode: This mode is for monitoring/controlling the output status of the parallel signals through communication commands only. Therefore, I/O that is unrelated to parallel terminal control is not possible.
 - Input: Parallel signal input is not possible. Command input is not possible. (However, the terminal status monitor, setting commands can be used)
 - Output: Parallel signal output is possible. Data output is not possible.

Load Scene Data

Loads scene data that is stored on the SD card inserted in the Touch Finder.

The source for scene data is the following fixed directory on the SD card.

\\Sensor name\\SCN

The file name is not case sensitive. The file name extension can be omitted.

Command (PLC to Vision Sensor)

First word of command area	Bits				Contents
	12 to 15	8 to 11	4 to 7	0 to 3	
+2	0001	0000	0000	0000	Command code
+3	0000	0000	0110	0000	
+4	0000	0000	0000	0000	The number of the scene to be loaded.
+5	0000	0000	0000	0000	
+6	0000	0000	0000	0000	<ul style="list-style-type: none"> • EtherNet/IP, PROFINET • PLC link File number to load (0 to 999)*1 File name to load 64 characters max.
+7	0000	0000	0000	0000	
+8	0000	0000	0000	0000	
:	:	:	:	:	---
+37	0000	0000	0000	0000	

*1 Loads the files named Scene_***.scn saved on the SD card. (***: Specified file number)

Response (Vision Sensor to PLC)

First word of response area	Bits				Contents
	12 to 15	8 to 11	4 to 7	0 to 3	
+2	0001	0000	0000	0000	Command code Response target command codes
+3	0000	0000	0110	0000	
+4	0000	0000	0000	0000	Response code Command execution result 0: OK, FFFFFFFF: NG
+5	0000	0000	0000	0000	

Load All Scene Data

Loads all scene data that is stored on the SD card inserted in the Touch Finder.

The source for all scene data is the following fixed directory on the SD card.

\\Sensor name\\SGP

The file name is not case sensitive. The file name extension can be omitted.

Command (PLC to Vision Sensor)

First word of command area	Bits				Contents	
	12 to 15	8 to 11	4 to 7	0 to 3		
+2	0010	0000	0000	0000	Command code	
+3	0000	0000	0110	0000		
+4	0000	0000	0000	0000	<ul style="list-style-type: none"> • EtherNet/IP, PROFINET File number to load (0 to 999)*1 	<ul style="list-style-type: none"> • PLC link File name to load 64 characters max.
+5	0000	0000	0000	0000		
+6	0000	0000	0000	0000		
:	:	:	:	:		
+35	0000	0000	0000	0000	---	

*1 Loads the files named SceneGroup_***.sgp saved on the SD card. (***: Specified file number)

Response (Vision Sensor to PLC)

First word of response area	Bits				Contents	
	12 to 15	8 to 11	4 to 7	0 to 3		
+2	0010	0000	0000	0000	Command code	
+3	0000	0000	0110	0000	Response target command codes	
+4	0000	0000	0000	0000	Response code	
+5	0000	0000	0000	0000	Command execution result 0: OK, FFFFFFFF: NG	

Load System Data

This command loads system data that is stored on the SD card inserted in the Touch Finder.

The source for system data is the following fixed directory on the SD card.

\\Sensor name\\SYD

The file name is not case sensitive. The file name extension can be omitted.

Command (PLC to Vision Sensor)

First word of command area	Bits				Contents	
	12 to 15	8 to 11	4 to 7	0 to 3		
+2	0011	0000	0000	0000	Command code	
+3	0000	0000	0110	0000		
+4	0000	0000	0000	0000	<ul style="list-style-type: none"> • EtherNet/IP, PROFINET File number to load (0 to 999)*1 	<ul style="list-style-type: none"> • PLC link File name to load 64 characters max.
+5	0000	0000	0000	0000		
+6	0000	0000	0000	0000		
:	:	:	:	:		
+35	0000	0000	0000	0000	---	

*1 Loads the files named SensorSys_***.syd saved on the SD card. (***: Specified file number)

Response (Vision Sensor to PLC)

First word of response area	Bits				Contents	
	12 to 15	8 to 11	4 to 7	0 to 3		
+2	0011	0000	0000	0000	Command code Response target command codes	
+3	0000	0000	0110	0000		
+4	0000	0000	0000	0000	Response code Command execution result 0: OK, FFFFFFFF: NG	
+5	0000	0000	0000	0000		

Load All Setting Data

This command loads all setting data (all scene data, system data, calibration group data) for the Sensor saved as a backup file from the SD card inserted in the Touch Finder.

The source for backup files is the following fixed directory on the SD card.

\Sensor name\BKD

The file name is not case sensitive. The file name extension can be omitted.

Important

After loading the all data with this command, be sure to restart the Vision Sensor to enable the data that was loaded.

Command (PLC to Vision Sensor)

First word of command area	Bits				Contents
	12 to 15	8 to 11	4 to 7	0 to 3	
+2	0101	0000	0000	0000	Command code
+3	0000	0000	0110	0000	
+4	0000	0000	0000	0000	<ul style="list-style-type: none"> • EtherNet/IP, PROFINET File number to load (0 to 999)*1
+5	0000	0000	0000	0000	
+6	0000	0000	0000	0000	
:	:	:	:	:	
+37	0000	0000	0000	0000	
					<ul style="list-style-type: none"> • PLC link File name to load 64 characters max. The file name extension (.bkd) can be omitted.

*1 Loads the files named SensorAll_***.bkd saved on the SD card. (***: Specified file number)

Response (Vision Sensor to PLC)

First word of response area	Bits				Contents
	12 to 15	8 to 11	4 to 7	0 to 3	
+2	0101	0000	0000	0000	Command code
+3	0000	0000	0110	0000	Response target command codes
+4	0000	0000	0000	0000	Response code
+5	0000	0000	0000	0000	Command execution result 0: OK, FFFFFFFF: NG

Load Calibration Data

This command loads calibration data that is stored on the SD card inserted in the Touch Finder as the specified calibration number.

The source for calibration data is the following fixed directory on the SD card.

\\Sensor name\\CLB

The file name is not case sensitive. The file name extension can be omitted.

Command (PLC to Vision Sensor)

First word of command area	Bits				Description
	12 to 15	8 to 11	4 to 7	0 to 3	
+2	1010	0000	0000	0000	Command code
+3	0000	0000	0110	0000	
+4	0000	0000	0000	0000	Calibration data number you want to load (0 to 31)
+5	0000	0000	0000	0000	
+6	0000	0000	0000	0000	<ul style="list-style-type: none"> • EtherNet/IP, PROFINET • PLC link File name to load 64 characters max. The file name extension (.clb) can be omitted.
+7	0000	0000	0000	0000	
+8	0000	0000	0000	0000	
:	:	:	:	:	
+37	0000	0000	0000	0000	File number to load (0 to 999) ^{*1}

*1 Loads the files named Calibration_***.clb saved on the SD card. (***: Specified file number)

Response (Vision Sensor to PLC)

First word of response area	Bits				Description
	12 to 15	8 to 11	4 to 7	0 to 3	
+2	1010	0000	0000	0000	Command code The command code for which the response applies is stored.
+3	0000	0000	0110	0000	
+4	0000	0000	0000	0000	Response code Command execution result 0: OK, FFFFFFFF: NG
+5	0000	0000	0000	0000	

Load All Calibration Data

This command loads all calibration data that is stored on the SD card inserted in the Touch Finder.

The source for all calibration data is the following fixed directory on the SD card.

\\Sensor name\\CGP

The file name is not case sensitive. The file name extension can be omitted.

Command (PLC to Vision Sensor)

First word of command area	Bits				Description
	12 to 15	8 to 11	4 to 7	0 to 3	
+2	1011	0000	0000	0000	Command code
+3	0000	0000	0110	0000	
+4	0000	0000	0000	0000	<ul style="list-style-type: none"> • EtherNet/IP, PROFINET • PLC link File name to load 64 characters max. The file name extension (.cgp) can be omitted.
+5	0000	0000	0000	0000	
+6	0000	0000	0000	0000	
:	:	:	:	:	
+35	0000	0000	0000	0000	

*1 Loads the files named CalibrationGroup_***.cgp saved on the SD card. (***: Specified file number)

Response (Vision Sensor to PLC)

First word of response area	Bits				Description
	12 to 15	8 to 11	4 to 7	0 to 3	
+2	1011	0000	0000	0000	Command code The command code for which the response applies is stored.
+3	0000	0000	0110	0000	
+4	0000	0000	0000	0000	Response code
+5	0000	0000	0000	0000	Command execution result 0: OK, FFFFFFFF: NG

Load Model Dictionary Data

This command loads model dictionary data that is stored on the SD card inserted in the Touch Finder as the model dictionary with the specified number.

The source for model dictionary data is the following fixed directory on the SD card.

\\Sensor name\\DIC

The file name is not case sensitive. The file name extension can be omitted.

Command (PLC to Vision Sensor)

First word of command area	Bits				Description
	12 to 15	8 to 11	4 to 7	0 to 3	
+2	1100	0000	0000	0000	Command code
+3	0000	0000	0110	0000	
+4	0000	0000	0000	0000	Model dictionary data number you want to load (0 to 31)
+5	0000	0000	0000	0000	
+6	0000	0000	0000	0000	<ul style="list-style-type: none"> • EtherNet/IP, PROFINET • PLC link File name to load 64 characters max. The file name extension (.dic) can be omitted.
+7	0000	0000	0000	0000	
+8	0000	0000	0000	0000	
:	:	:	:	:	
+37	0000	0000	0000	0000	---

*1 Loads the files named Dictionary_***.dic saved on the SD card. (***: Specified file number)

Response (Vision Sensor to PLC)

First word of response area	Bits				Description
	12 to 15	8 to 11	4 to 7	0 to 3	
+2	1100	0000	0000	0000	Command code The command code for which the response applies is stored.
+3	0000	0000	0110	0000	
+4	0000	0000	0000	0000	Response code Command execution result 0: OK, FFFFFFFF: NG
+5	0000	0000	0000	0000	

Load All Model Dictionary Data

This command loads all model dictionary data that is stored on the SD card inserted in the Touch Finder. The source for all model dictionary data is the following fixed directory on the SD card.

\\Sensor name\DGP

The file name is not case sensitive. The file name extension can be omitted.

Command (PLC to Vision Sensor)

First word of command area	Bits				Description
	12 to 15	8 to 11	4 to 7	0 to 3	
+2	1101	0000	0000	0000	Command code
+3	0000	0000	0110	0000	
+4	0000	0000	0000	0000	<ul style="list-style-type: none"> • EtherNet/IP, PROFINET • PLC link File name to load 64 characters max. The file name extension (.dgp) can be omitted.
+5	0000	0000	0000	0000	
+6	0000	0000	0000	0000	
:	:	:	:	:	
+35	0000	0000	0000	0000	

*1 Loads the files named DictionaryAll_***.dgp saved on the SD card. (***: Specified file number)

Response (Vision Sensor to PLC)

First word of response area	Bits				Description
	12 to 15	8 to 11	4 to 7	0 to 3	
+2	1101	0000	0000	0000	Command code The command code for which the response applies is stored.
+3	0000	0000	0110	0000	
+4	0000	0000	0000	0000	Response code Command execution result 0: OK, FFFFFFFF: NG
+5	0000	0000	0000	0000	

Save Scene Data

This command saves scene data to the SD card inserted in the Touch Finder as a file.

The destination for scene data is the following fixed directory on the SD card.

\\Sensor name\\SCN

The file name is not case sensitive. The file name extension can be omitted.

Command (PLC to Vision Sensor)

First word of command area	Bits				Contents	
	12 to 15	8 to 11	4 to 7	0 to 3		
+2	0001	0000	0000	0000	Command code	
+3	0000	0000	0111	0000		
+4	0000	0000	0000	0000	Number of the scene to be saved.	
+5	0000	0000	0000	0000		
+6	0000	0000	0000	0000	<ul style="list-style-type: none"> • EtherNet/IP, PROFINET File number to load (0 to 999)*1 	
+7	0000	0000	0000	0000		<ul style="list-style-type: none"> • PLC link File name to load 64 characters max. The file name extension (.scn) can be omitted.
+8	0000	0000	0000	0000		
:	0000	0000	0000	0000		
+37	0000	0000	0000	0000		

*1 Saved as a file named Scene_***.scn. (***: Specified file number)

Response (Vision Sensor to PLC)

First word of response area	Bits				Contents
	12 to 15	8 to 11	4 to 7	0 to 3	
+2	0001	0000	0000	0000	Command code Response target command codes
+3	0000	0000	0111	0000	
+4	0000	0000	0000	0000	Response code Command execution result 0: OK, FFFFFFFF: NG
+5	0000	0000	0000	0000	

Save All Scene Data

This command saves all scene data as a file to the SD card inserted in the Touch Finder.

The destination for all scene data is the following fixed directory on the SD card.

\\Sensor name\\SGP

The file name is not case sensitive. The file name extension can be omitted.

Command (PLC to Vision Sensor)

First word of command area	Bits				Contents	
	12 to 15	8 to 11	4 to 7	0 to 3		
+2	0010	0000	0000	0000	Command code	
+3	0000	0000	0111	0000		
+4	0000	0000	0000	0000	<ul style="list-style-type: none"> • EtherNet/IP, PROFINET File number to load (0 to 999)*1 • PLC link File name to load 64 characters max. The file name extension (.sgp) can be omitted. 	
+5	0000	0000	0000	0000		
+6	0000	0000	0000	0000		
:	:	:	:	:	---	
+35	0000	0000	0000	0000		

*1 Saved as a file named SceneGroup_***.sgp. (***: Specified file number)

Response (Vision Sensor to PLC)

First word of response area	Bits				Contents	
	12 to 15	8 to 11	4 to 7	0 to 3		
+2	0010	0000	0000	0000	Command code Response target command codes	
+3	0000	0000	0111	0000		
+4	0000	0000	0000	0000	Response code Command execution result 0: OK, FFFFFFFF: NG	
+5	0000	0000	0000	0000		

Save System Data

Saves system data as a file to the SD card inserted in the Touch Finder.

The destination for system data is the following fixed directory on the SD card.

\\Sensor name\\SYD

The file name is not case sensitive. The file name extension can be omitted.

Command (PLC to Vision Sensor)

First word of command area	Bits				Contents	
	12 to 15	8 to 11	4 to 7	0 to 3		
+2	0011	0000	0000	0000	Command code	
+3	0000	0000	0111	0000		
+4	0000	0000	0000	0000	<ul style="list-style-type: none"> • EtherNet/IP, PROFINET File number to load (0 to 999)*1 	<ul style="list-style-type: none"> • PLC link File name to load 64 characters max. The file name extension (.syd) can be omitted.
+5	0000	0000	0000	0000		
+6	0000	0000	0000	0000		
:	:	:	:	:		
+35	0000	0000	0000	0000	---	

*1 Saved as a file named SensorSys_***.syd. (***: Specified file number)

Response (Vision Sensor to PLC)

First word of response area	Bits				Contents	
	12 to 15	8 to 11	4 to 7	0 to 3		
+2	0011	0000	0000	0000	Command code Response target command codes	
+3	0000	0000	0111	0000		
+4	0000	0000	0000	0000	Response code Command execution result 0: OK, FFFFFFFF: NG	
+5	0000	0000	0000	0000		

Save Image Data

Saves image data saved in the Sensor's memory by the logging function to the SD card inserted in the Touch Finder as ifz data.

The destination for image data is the following fixed directory on the SD card.

\\Sensor name\\LOGIMAGE\\Number*1

*1 Number is a five digit number starting from 00000. The images are saved in increments of 100 images for each number, and when there are over 100 images, the directory with the next number is created.

The file name is not case sensitive. The file name extension can be omitted.

Command (PLC to Vision Sensor)

First word of command area	Bits				Contents
	12 to 15	8 to 11	4 to 7	0 to 3	
+2	0100	0000	0000	0000	Command code
+3	0000	0000	0111	0000	
+4	0000	0000	0000	0000	Image data No.
+5	0000	0000	0000	0000	
+6	0000	0000	0000	0000	File name*1 (only when using the PLC link communication protocol)
:	:	:	:	:	
+37	0000	0000	0000	0000	File name to save 64 characters max. The file name extension (.ifz) can be omitted.

*1 When using the EtherNet/IP or PROFINET communication protocol, the file name is automatically created as follows.

img_ScnNNN_YYYY_MM_DD-HH_mm_ss(S)_TTTT_XX.ifz

img	Prefix string. The string can be set as desired with the following setting. ▶  (Setup Mode or Run Mode) – [TF settings] – [File format]
ScnNNN	Scn + measured scene number (0 to 31)
YYYY_MM_DD	Date that the image data was saved to the Touch Finder SD card*1
HH_mm_ss	Time that the image data was saved to the Touch Finder SD card*1
(S)	Image data number (0 to 19)
TTTT	Number of measurements since the Sensor was started. Reset when the power supply is turned OFF.
XX	Total judgment (OK/NG)

*1 The date and time are not recorded in the image data. Therefore, this is not the date and time that the measurement was performed, this is the date and time the image data file was saved from the Sensor to the Touch Finder SD card by this command.

For example, when performing the 10th measurement with scene 1 after the Sensor's power supply has been turned on, and the execution time of this command is December 5, 2013, at 22:10:21
img_Scn001_2013_12_05-22_01_21(1)_10_OK.ifz

Response (Vision Sensor to PLC)

First word of response area	Bits				Contents
	12 to 15	8 to 11	4 to 7	0 to 3	
+2	0100	0000	0000	0000	Command code Response target command codes
+3	0000	0000	0111	0000	
+4	0000	0000	0000	0000	Response code Command execution result 0: OK, FFFFFFFF: NG
+5	0000	0000	0000	0000	

Save All Image Data

This command saves all image data saved in the Sensor's memory by the logging function to the SD card inserted in the Touch Finder as ifz data.

The backup data destination and file name are fixed as follows.

- Destination

The following fixed directory on the SD card.

\Sensor name\LOGIMAGE\Number*

* Number is a five digit number starting from 00000. The images are saved in increments of 100 images for each number, and when there are over 100 images, the directory with the next number is created.

The file name is not case sensitive. The file name extension can be omitted.

- File name

Automatically created as follows.

img_ScnNNN_YYYY_MM_DD-HH_mm_ss(S)_TTTT_XX.ifz

img	Prefix string. The string can be set as desired with the following setting. ▶  (Setup Mode or Run Mode) – [TF settings] – [File format]
ScnNNN	Scn + measured scene number (0 to 31)
YYYY_MM_DD	Date that the image data was saved to the Touch Finder SD card* ¹
HH_mm_ss	Time that the image data was saved to the Touch Finder SD card* ¹
(S)	Image data number (0 to 19)
TTTT	Number of measurements since the Sensor was started. Reset when the power supply is turned OFF.
XX	Total judgment (OK/NG)

*¹ The date and time are not recorded in the image data. Therefore, this is not the date and time that the measurement was performed, this is the date and time the image data file was saved from the Sensor to the Touch Finder SD card by this command.

For example, when performing the 10th measurement with scene 1 after the Sensor's power supply has been turned on, and the execution time of this command is December 5, 2013, at 22:10:21
img_Scn001_2013_12_05-22_01_21(1)_10_OK.ifz

Command (PLC to Vision Sensor)

First word of command area	Bits				Contents
	12 to 15	8 to 11	4 to 7	0 to 3	
+2	0100	0000	0001	0000	Command code
+3	0000	0000	0111	0000	

Response (Vision Sensor to PLC)

First word of response area	Bits				Contents
	12 to 15	8 to 11	4 to 7	0 to 3	
+2	0100	0000	0001	0000	Command code
+3	0000	0000	0111	0000	Response target command codes
+4	0000	0000	0000	0000	Response code
+5	0000	0000	0000	0000	Command execution result 0: OK, FFFFFFFF: NG

Save All Setting Data

This command saves all setting data (all scene data, system data, calibration group data) for the Sensor to the SD card inserted in the Touch Finder as a backup file.

\Sensor name\BKD

The file name is not case sensitive. The file name extension can be omitted.

Command (PLC to Vision Sensor)

First word of command area	Bits				Contents
	12 to 15	8 to 11	4 to 7	0 to 3	
+2	0101	0000	0000	0000	Command code
+3	0000	0000	0111	0000	
+4	0000	0000	0000	0000	<ul style="list-style-type: none"> • EtherNet/IP, PROFINET File number to save (0 to 999)*1 <ul style="list-style-type: none"> • PLC link File name to load 64 characters max. The file name extension (.bkd) can be omitted.
+5	0000	0000	0000	0000	
+6	0000	0000	0000	0000	
:	:	:	:	:	
+37	0000	0000	0000	0000	---

*1 Saved as a file named SensorAll_***.bkd. (***: Specified file number)

Response (Vision Sensor to PLC)

First word of response area	Bits				Contents
	12 to 15	8 to 11	4 to 7	0 to 3	
+2	0101	0000	0000	0000	Command code
+3	0000	0000	0111	0000	Response target command codes
+4	0000	0000	0000	0000	Response code
+5	0000	0000	0000	0000	Command execution result 0: OK, FFFFFFFF: NG

Save Calibration Data

Saves the data for the specified calibration number as a file to the SD card inserted in the Touch Finder. The destination for scene data is the following fixed directory on the SD card.

\\Sensor name\\CLB

The file name is not case sensitive. The file name extension can be omitted.

Command (PLC to Vision Sensor)

First word of command area	Bits				Description
	12 to 15	8 to 11	4 to 7	0 to 3	
+2	1010	0000	0000	0000	Command code
+3	0000	0000	0111	0000	
+4	0000	0000	0000	0000	Calibration number to save
+5	0000	0000	0000	0000	
+6	0000	0000	0000	0000	<ul style="list-style-type: none"> EtherNet/IP, PROFINET File number to save (0 to 999)^{*1} PLC link File name to load 64 characters max. The file name extension (.clb) can be omitted.
+7	0000	0000	0000	0000	
+8	0000	0000	0000	0000	
:	:	:	:	:	
+37	0000	0000	0000	0000	---

*1 Saved as a file named Calibration_***.clb. (***: Specified file number)

Response (Vision Sensor to PLC)

First word of response area	Bits				Description
	12 to 15	8 to 11	4 to 7	0 to 3	
+2	1010	0000	0000	0000	Command code
+3	0000	0000	0111	0000	The command code for which the response applies is stored.
+4	0000	0000	0000	0000	Response code
+5	0000	0000	0000	0000	Command execution result 0: OK, FFFFFFFF: NG

Save All Calibration Data

Saves all calibration data as a file to the SD card inserted in the Touch Finder.

The destination for all calibration data is the following fixed directory on the SD card.

\\Sensor name\\CGP

The file name is not case sensitive. The file name extension can be omitted.

Command (PLC to Vision Sensor)

First word of command area	Bits				Description
	12 to 15	8 to 11	4 to 7	0 to 3	
+2	1011	0000	0000	0000	Command code
+3	0000	0000	0111	0000	
+4	0000	0000	0000	0000	<ul style="list-style-type: none"> • EtherNet/IP, PROFINET • PLC link File name to load 64 characters max. The file name extension (.sgp) can be omitted.
+5	0000	0000	0000	0000	
+6	0000	0000	0000	0000	
:	:	:	:	:	
+35	0000	0000	0000	0000	

*1 Saved as a file named CalibrationGroup_***.cgp. (***) Specified file number

Response (Vision Sensor to PLC)

First word of response area	Bits				Description
	12 to 15	8 to 11	4 to 7	0 to 3	
+2	1011	0000	0000	0000	Command code The command code for which the response applies is stored.
+3	0000	0000	0111	0000	
+4	0000	0000	0000	0000	Response code
+5	0000	0000	0000	0000	Command execution result 0: OK, FFFFFFFF: NG

Save Model Dictionary Data

Saves the specified number of model dictionary data as a file to the SD card inserted in the Touch Finder. The destination for scene data is the following fixed directory on the SD card.

\\Sensor name\\DIC

The file name is not case sensitive. The file name extension can be omitted.

Command (PLC to Vision Sensor)

First word of command area	Bits				Description
	12 to 15	8 to 11	4 to 7	0 to 3	
+2	1100	0000	0000	0000	Command code
+3	0000	0000	0111	0000	
+4	0000	0000	0000	0000	Model dictionary data number to save
+5	0000	0000	0000	0000	
+6	0000	0000	0000	0000	<ul style="list-style-type: none"> • EtherNet/IP, PROFINET File number to save (0 to 999)^{*1}
+7	0000	0000	0000	0000	
+8	0000	0000	0000	0000	
:	:	:	:	:	
+37	0000	0000	0000	0000	<ul style="list-style-type: none"> • PLC link File name to load 64 characters max. The file name extension (.dic) can be omitted.

*1 Saved as a file named Dictionary_***.dic. (***: Specified file number)

Response (Vision Sensor to PLC)

First word of response area	Bits				Description
	12 to 15	8 to 11	4 to 7	0 to 3	
+2	1100	0000	0000	0000	Command code
+3	0000	0000	0111	0000	The command code for which the response applies is stored.
+4	0000	0000	0000	0000	Response code
+5	0000	0000	0000	0000	Command execution result 0: OK, FFFFFFFF: NG

Save All Model Dictionary Data

Saves all model dictionary data as a file to the SD card inserted in the Touch Finder.

The destination for all model dictionary data is the following fixed directory on the SD card.

\Sensor name\DGP

The file name is not case sensitive. The file name extension can be omitted.

Command (PLC to Vision Sensor)

First word of command area	Bits				Description
	12 to 15	8 to 11	4 to 7	0 to 3	
+2	1101	0000	0000	0000	Command code
+3	0000	0000	0111	0000	
+4	0000	0000	0000	0000	<ul style="list-style-type: none"> • EtherNet/IP, PROFINET • PLC link File name to load 64 characters max. The file name extension (.dgp) can be omitted.
+5	0000	0000	0000	0000	
+6	0000	0000	0000	0000	
:	:	:	:	:	
+35	0000	0000	0000	0000	

*1 Saved as a file named DictionaryAll_***.dgp. (***: Specified file number)

Response (Vision Sensor to PLC)

First word of response area	Bits				Description
	12 to 15	8 to 11	4 to 7	0 to 3	
+2	1101	0000	0000	0000	Command code
+3	0000	0000	0111	0000	The command code for which the response applies is stored.
+4	0000	0000	0000	0000	Response code
+5	0000	0000	0000	0000	Command execution result 0: OK, FFFFFFFF: NG

Save Latest Input Image Data

Saves the latest input image to the SD card inserted in the Touch Finder as ifz data.

The destination for image data is the following fixed directory on the SD card.

\Sensor name\CAPTURE\Number*

* Number is a five digit number starting from 00000. The images are saved in increments of 100 images for each number, and when there are over 100 images, the directory with the next number is created.

The file name is not case sensitive. The file name extension can be omitted.

Command (PLC to Vision Sensor)

First word of command area	Bits				Description
	12 to 15	8 to 11	4 to 7	0 to 3	
+2	0100	0000	0010	0000	Command code
+3	0000	0000	0111	0000	
+4	0000	0000	0000	0000	File name* ¹ (only when using the PLC link communication protocol) File name to save 64 characters max. The file name extension (.ifz) can be omitted.
:	:	:	:	:	
+35	0000	0000	0000	0000	

*1 When using the EtherNet/IP or PROFINET communication protocol, the file name is automatically created as follows.

YYYY_MM_DD-HH_mm_ss.ifz

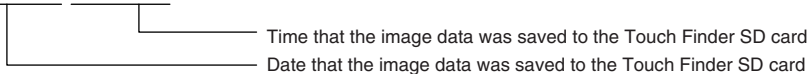

The date and time are not recorded in the image data.

Therefore, the date and time that make up the file name are not the date and time that the measurement was performed, they are the date and time the image data file was saved from the Sensor to the Touch Finder SD card by this command.

Response (Vision Sensor to PLC)

First word of response area	Bits				Description
	12 to 15	8 to 11	4 to 7	0 to 3	
+2	0100	0000	0010	0000	Command code The command code for which the response applies is stored.
+3	0000	0000	0111	0000	
+4	0000	0000	0000	0000	Response code
+5	0000	0000	0000	0000	Command execution result 0: OK, FFFFFFFF: NG

Save Measurement Data

Saves measurement data saved in the Sensor's memory by the logging function to the SD card inserted in the Touch Finder as csv data.

The destination for measurement data is the following fixed directory on the SD card.

\Sensor name\LOGDATA

The file name is automatically created as follows.

YYYY_MM_DD-HH_mm_ss.csv

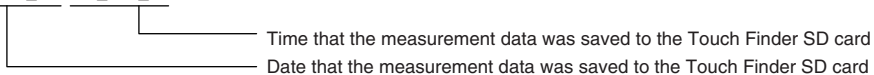

The date and time that make up the measurement data file name are not the date and time that the measurement was performed, they are the date and time the measurement data file was saved from the Sensor to the Touch Finder SD card by this command.

The file name is not case sensitive. The file name extension can be omitted.

Command (PLC to Vision Sensor)

First word of command area	Bits				Description
	12 to 15	8 to 11	4 to 7	0 to 3	
+2	0111	0000	0000	0000	Command code
+3	0000	0000	0111	0000	
+4	0000	0000	0000	0000	
:	:	:	:	:	File name*1 (only when using the PLC link communication protocol)
+35	0000	0000	0000	0000	File name to save 64 characters max. The file name extension (.csv) can be omitted.

Response (Vision Sensor to PLC)

First word of response area	Bits				Description
	12 to 15	8 to 11	4 to 7	0 to 3	
+2	0111	0000	0010	0000	Command code
+3	0000	0000	0111	0000	The command code for which the response applies is stored.
+4	0000	0000	0000	0000	Response code
+5	0000	0000	0000	0000	Command execution result 0: OK, FFFFFFFF: NG

Save Statistical Data

Saves statistical data saved in the Sensor's memory by the logging function to the SD card inserted in the Touch Finder as csv data.

The destination for statistical data is the following fixed directory on the SD card.

\Sensor name\LOGDATA

The file name is automatically created as follows.

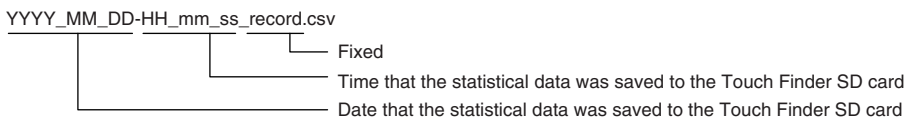

The date and time that make up the statistical data file name are not the date and time that the measurement was performed, they are the date and time the statistical data file was saved from the Sensor to the Touch Finder SD card by this command.

The file name is not case sensitive. The file name extension can be omitted.

Command (PLC to Vision Sensor)

First word of command area	Bits				Description
	12 to 15	8 to 11	4 to 7	0 to 3	
+2	1000	0000	0000	0000	Command code
+3	0000	0000	0111	0000	

Response (Vision Sensor to PLC)

First word of response area	Bits				Description
	12 to 15	8 to 11	4 to 7	0 to 3	
+2	1000	0000	0010	0000	Command code
+3	0000	0000	0111	0000	The command code for which the response applies is stored.
+4	0000	0000	0000	0000	Response code
+5	0000	0000	0000	0000	Command execution result 0: OK, FFFFFFFF: NG

Details of No-protocol TCP, No-protocol UDP, and No-protocol RS-232C Commands

Details of the commands in this section are described in the command format of no-protocol (TCP). When using commands in no-protocol (UDP), note the following differences from no-protocol (TCP).

- Command format

A delimiter is not necessary in the command format.

- Responses

A delimiter is not added.

When the acquired data and OK response are sent in succession, the acquired data and OK response are sent as separate packets.

Execution Commands

CLRERR

Clear Errors

This command clears the error output status (error output and error indicator).

<Command Format>

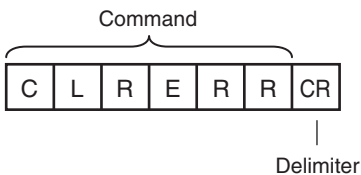

<Response Format>

When the Command Is Processed Normally

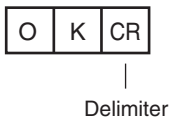

When the Command Is Not Processed Normally

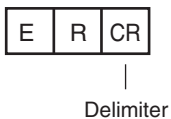

CLRMEAS

Clear Measurement Values

This command clears the measurement values.

<Command Format>

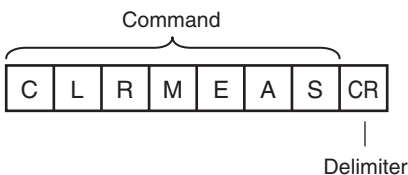

<Response Format>

When the Command Is Processed Normally

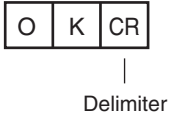

When the Command Is Not Processed Normally

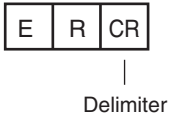

CLRTOTAL or CTD

Clear Statistical Data

This command clears the statistical data (such as the number of measurements, the number of NG overall judgments, the NG rate, and other information since the power supply was turned ON) produced by the logging function held by the Sensor.

<Command Format>

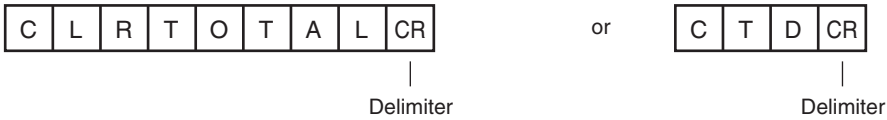

<Response Format>

When the Command Is Processed Normally

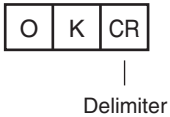

When the Command Is Not Processed Normally

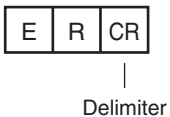

DATASAVE

Save Settings

This command saves the current system data and all scene data in the Sensor.

<Command Format>

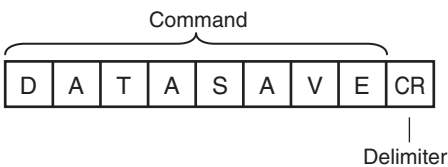

<Response Format>

When the Command Is Processed Normally

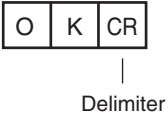

When the Command Is Not Processed Normally

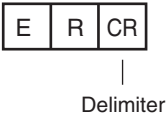

ECHO or EEC

Executes Echo-back (Loop-back).

This command returns as is any character string sent by an external device. Only single-byte alphanumeric characters can be used.

<Command format>

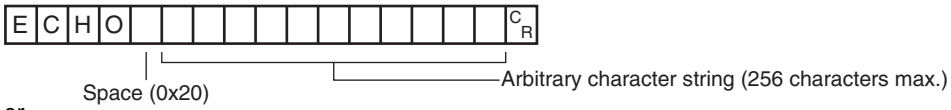

or

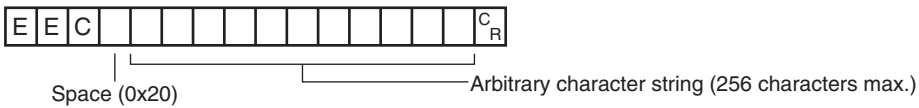

<Response format>

When processing is performed normally

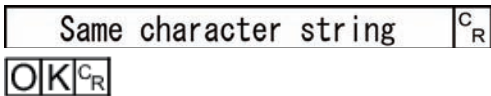

When processing is not performed normally



<Parameters explanation>

Arbitrary character string	Sets the character string returned as is. The response is the character string set here as is.
----------------------------	--

ITEMTEACH or IT

Perform Teaching (Inspection Item)

This command updates the reference data for the specified inspection item. The model data is also updated for inspection items that have model data.

<Command Format>

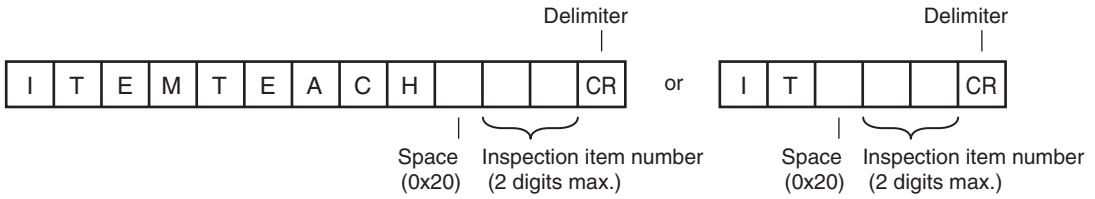

<Response Format>

When the Command Is Processed Normally

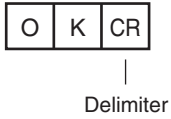

When the Command Is Not Processed Normally

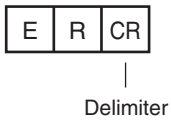

<Parameter Descriptions>

Inspection item number	Specifies the item number of the inspection item that teaching will be performed on. (0 to 31) Only "0" can be specified with the FQ2-S1 series.
------------------------	---

MEASURE or M

Start Continuous Measurements

This command starts continuous measurements.

If data output is not set, only continuous measurement is performed.

If data output is set, continuous measurement is performed and the results corresponding to the number of measurements made are returned as response data.

<Command Format>

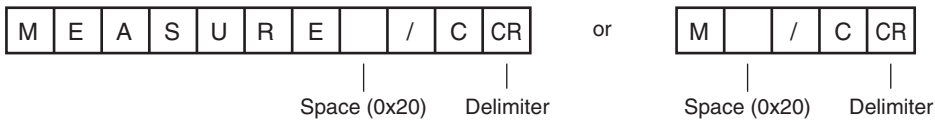

<Response Format>

When the Command Is Processed Normally

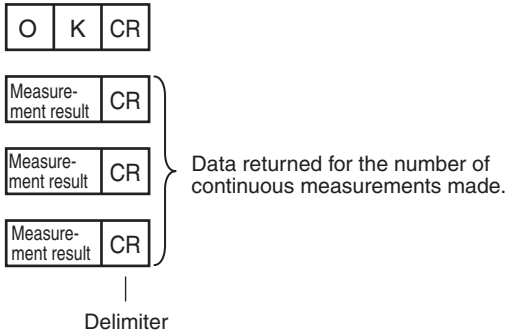

When the Command Is Not Processed Normally

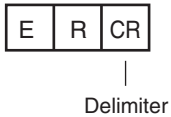

<Parameter Descriptions>

Measurement result	<p>The measurement results corresponding to the number of measurements made are output when data output is set. The measurement result is not output when data output is not set.</p> <p> Setting the Data to Output Automatically after Measurements: p. 169</p>
--------------------	---

End Continuous Measurements

The command ends continuous measurements.

<Command Format>

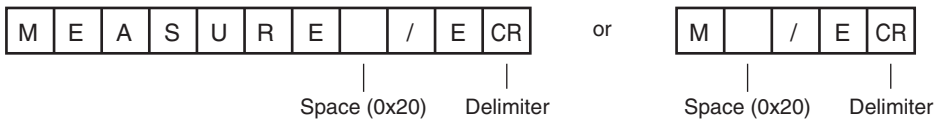

<Response Format>

When the Command Is Processed Normally

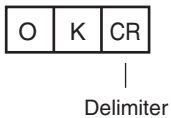

When the Command Is Not Processed Normally

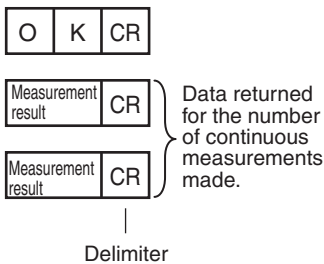

MODEL

Re-register Models

This command re-registers the models for registered Search and Color Data inspection items.

<Command Format>

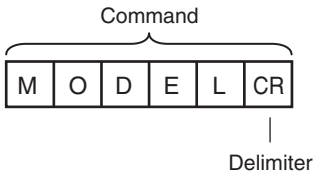

<Response Format>

When the Command Is Processed Normally

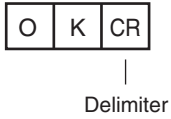

When the Command Is Not Processed Normally

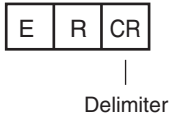

POSITIONTEACH or PT

Perform Teaching (Filter/Position Compensation Item)

This command updates reference data for the specified image adjustment processing item (filter item/position compensation item).

The model data is also updated in image adjustment processing items that have model data.

<Command Format>

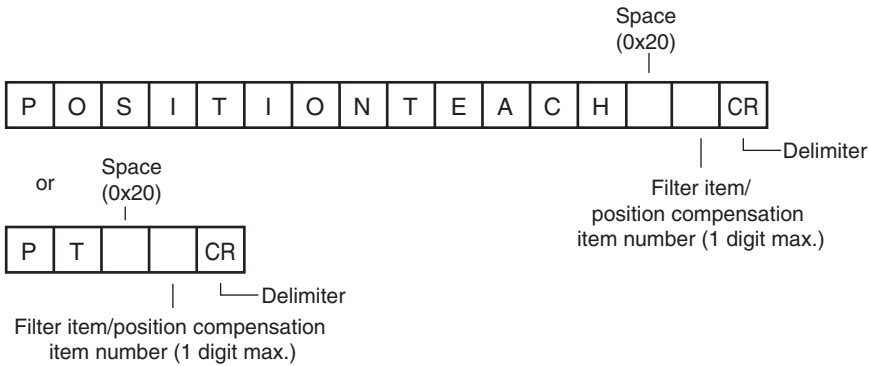

<Response Format>

When the Command Is Processed Normally

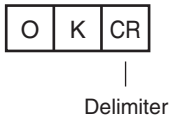

When the Command Is Not Processed Normally

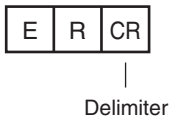

<Parameter Descriptions>

Filter item/position compensation item number	Specifies the item number of the filter item or position compensation item that teaching will be performed on. (0 to 7)
---	---

REGIMAGE or RID

Set a Registered Image

Sets the latest image or a specified logging image as a registered image.

Registered images are saved to the following directory on the SD card or PC Tool.

\\Sensor name\\REGIMAGE*

The image specified as a registered image can be loaded as a measurement image with the Acquire Registered Image command.

 Acquire Registered Image p.300

A maximum of 1000 registered images (image registration number: 0 to 999) can be set.

* For the PC Tool, the data is saved in the "\\.\My Documents\OMRON FQ\" folder.

<Command Format>

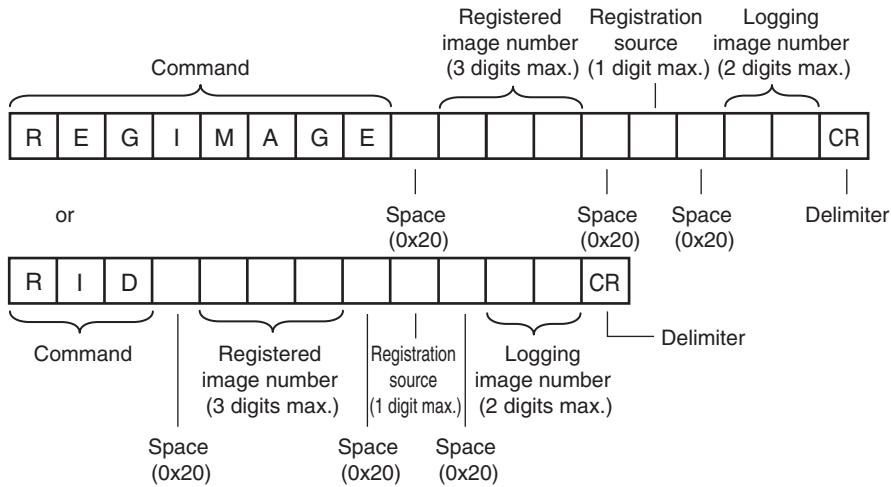

<Response Format>

When the Command Is Processed Normally

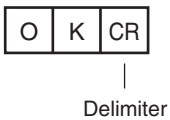

When the Command Is Not Processed Normally

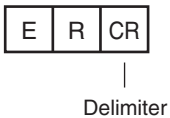

<Parameter Descriptions>

Registered image number	Specifies the image to be loaded as the measurement image. The image is registered in advance with the Set a Registered Image command and assigned a number. (0 to 999)
Registration source	Specifies the image to be set as the registered image. 0: Latest measurement image 1: Sensor logging image
Logging image number	This argument is only specified when setting the Sensor's logging images as registered images. (0 to 19) If the registration source is 0: Latest measurement image, this argument is not required.

RESET

Resets the Sensor

This command resets the Sensor.

<Command Format>

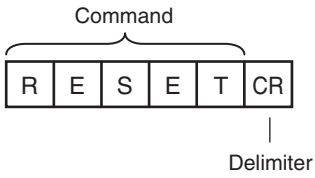

<Response Format>

When the Command Is Processed Normally

If process is completed normally, the Sensor is restarted. There is therefore no response.

When the Command Is Not Processed Normally

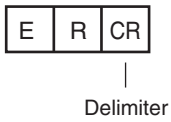

TEACH

Perform Teaching

This command performs teaching for all of the registered items and image adjustment items.

<Command Format>

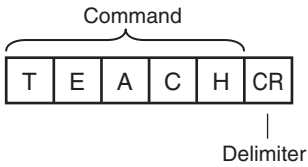

<Response Format>

When the Command Is Processed Normally

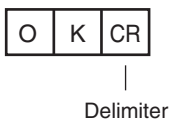

When the Command Is Not Processed Normally

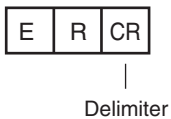

TIMER or TMR

This command executes the specified command after the specified waiting time elapses.

<Command Format>

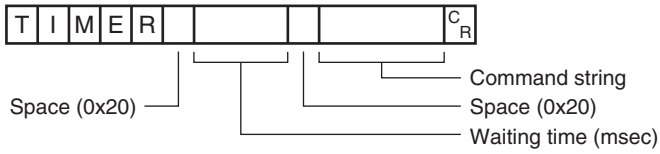

or

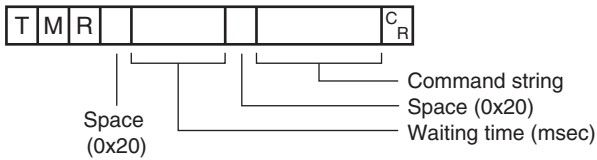

<Response Format>

When the Command Is Processed Normally

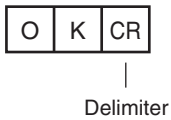

When the Command Is Not Processed Normally

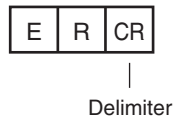

<Parameter Descriptions>

Waiting time (msec)	Specifies the waiting time for the command that will be executed with this command. (100 to 99,999)
Command string	Specifies the string for the command that will be executed with this command. Only one type of command can be specified for execution with this command. This timer command cannot be specified.

UPDATEREFITEM or URI

Re-register Reference Values (Inspection Item)

This command re-registers the reference value for the specified inspection item based on the previously loaded image.

The model is not updated.

<Command Format>

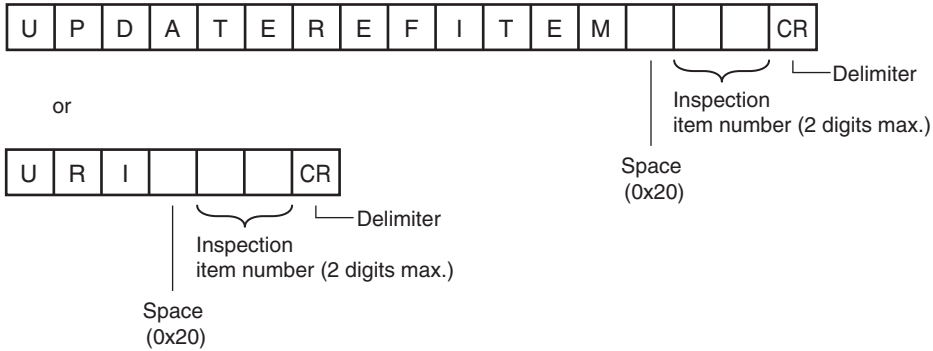

<Response Format>

When the Command Is Processed Normally

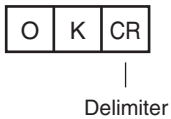

When the Command Is Not Processed Normally

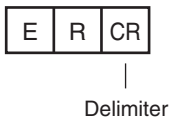

<Parameter Descriptions>

Inspection item number	Specifies the item number of the inspection item that will have its reference values re-registered. (0 to 31) Only "0" can be specified with the FQ2-S1 series.
------------------------	--

UPDATEREFPOS or URP

Re-register Reference Values (Position Compensation Item)

This command re-registers the reference value for the specified position compensation item based on the previously loaded image.

<Command Format>

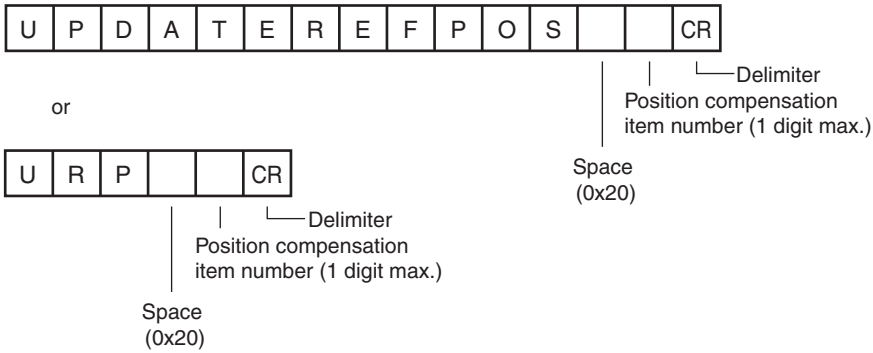

<Response Format>

When the Command Is Processed Normally

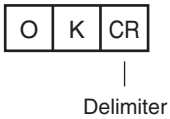

When the Command Is Not Processed Normally

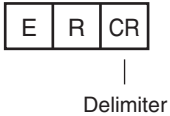

<Parameter Descriptions>

Position compensation item number	Specifies the item number of the position compensation item that will have its reference values re-registered. (0 to 7)
-----------------------------------	---

Commands to Read Data

CAMDATA or CD

Acquire Camera Parameter

This command acquires the value of the specified camera parameter.

 Camera parameter numbers: p. 219

<Command Format>

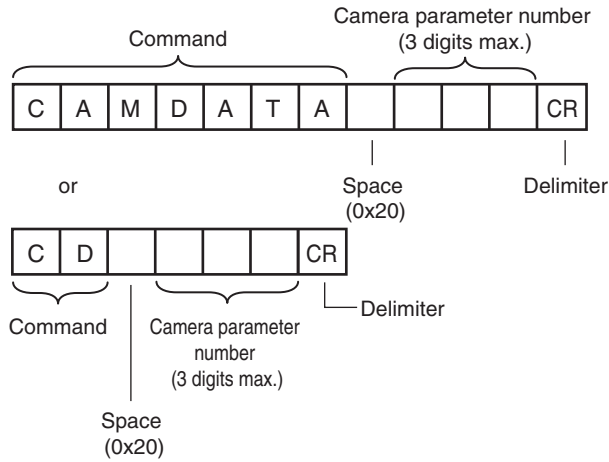

<Response Format>

When the Command Is Processed Normally

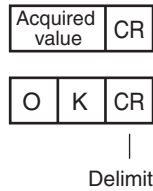

When the Command Is Not Processed Normally

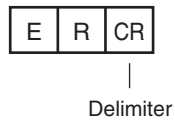

<Parameter Descriptions>

Camera parameter number*	Specifies the number that corresponds to the camera parameter to be acquired.
Acquired value	Returns the specified camera parameter.

DICNOLIST or DNL

Acquire List of Registered Dictionary Data Numbers

This command acquires the list of registered dictionary data numbers.

<Command Format>

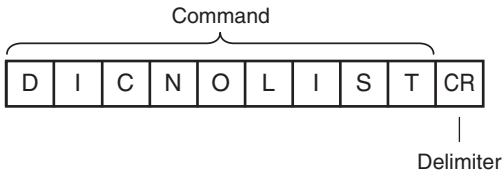

or

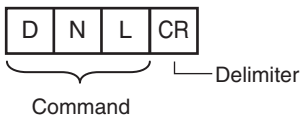

<Response Format>

When the Command Is Processed Normally

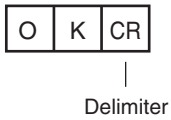
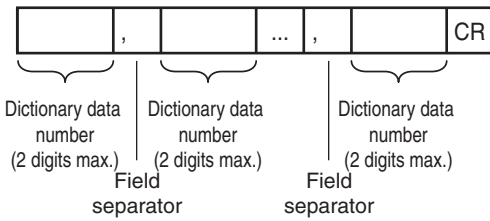

When the Command Is Not Processed Normally

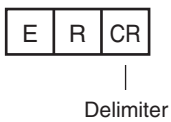

<Parameter Descriptions>

Dictionary data number	Returns the registered dictionary data numbers. When there are multiple items of dictionary data, they are separated with the field separator.
------------------------	--

DIOFFSET or DIO

Acquire Terminal Offset Data

This command acquires the terminal offset data that is added to the IN0 to IN4 command parameters when executing parallel commands.

If no value has been set with the Set Terminal Offset command, "0" is returned as the terminal offset value and "OK" (ended normally) is returned for the end code.

 Set Terminal Offset Data: p.306

<Command Format>

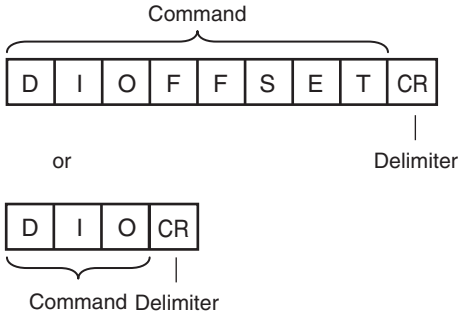

<Response Format>

When the Command Is Processed Normally

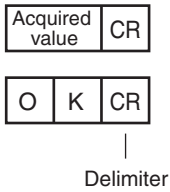

When the Command Is Not Processed Normally

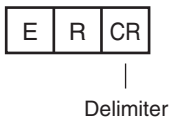

<Parameter Descriptions>

Acquired value	Returns the value added to the IN0 to IN4 command parameters when executing parallel commands.
----------------	--

DIPORTCOND or DPC

Batch Acquire IN Terminal Statuses

Batch acquires the ON/OFF status for the IN terminals.

<Command Format>

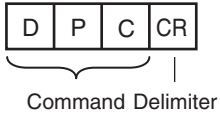
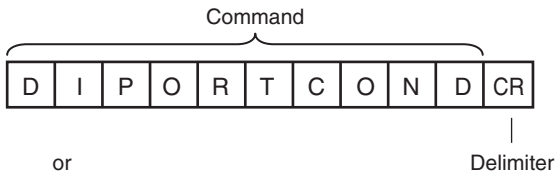

<Response Format>

When the Command Is Processed Normally



Delimiter

When the Command Is Not Processed Normally



Delimiter

<Parameter Descriptions>

Acquired value	<p>Returns the acquired terminal statuses as a hexadecimal value. (ON:1, OFF:0) (0 to 255)</p> <p>BIT0: IN0 BIT1: IN1 BIT2: IN2 BIT3: IN3 BIT4: IN4 BIT5: IN5 BIT6: IN6 BIT7: IN7</p> <p>For example, when IN0 and IN4 are ON 17 is returned.</p>
----------------	---

ERRGET

Acquire Error Information

This command acquires the latest error code from the Sensor.

<Command Format>

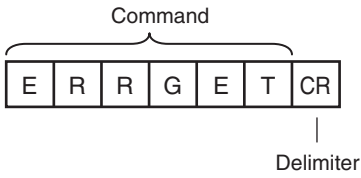

<Response Format>

When the Command Is Processed Normally

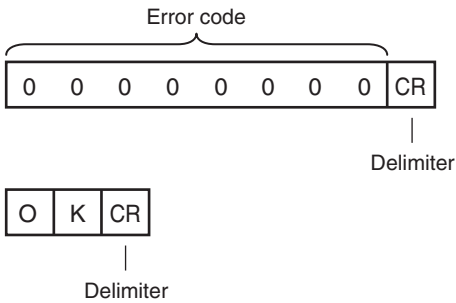

When the Command Is Not Processed Normally

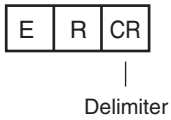

<Parameter Descriptions>

Error code	Returns the latest error code. If there is no error history, the response is 00000000.  Section 8 Troubleshooting in Vision Sensor FQ2-S/CH Series User's Manual (Cat. No. Z337)
------------	---

GETITEMFIGPARAM or GIFF

Acquire Measurement Region/Model Region Information Set for an Inspection Item

This command acquires the parameters for the measurement region or model registration region set for an inspection item.

Note

To check the figure number to be used when specifying a figure to change the settings of with the Set Inspection Item Figure command, do so using this command.

<Command Format>

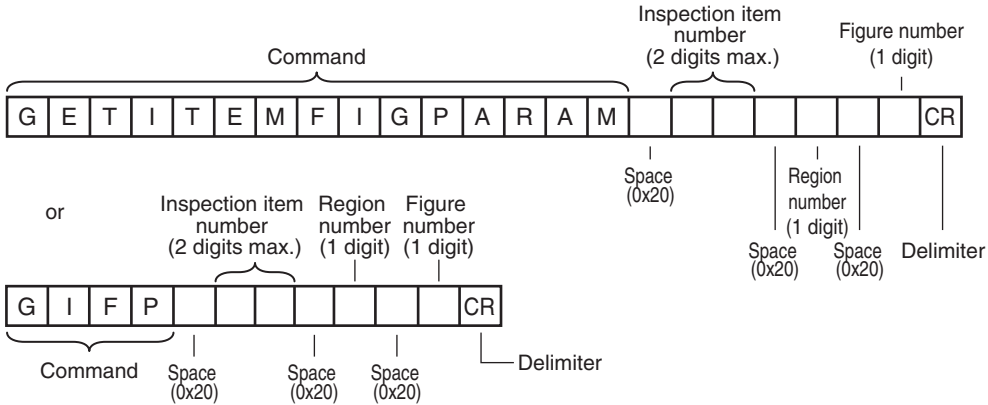

<Response Format>

When the Command Is Processed Normally

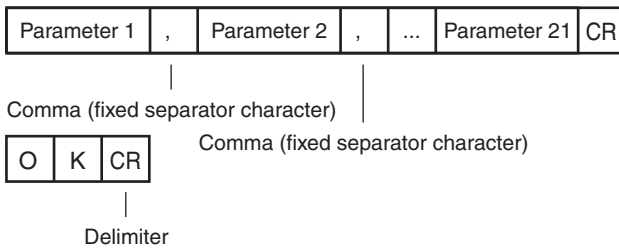

When the Command Is Not Processed Normally

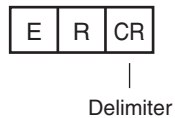

<Parameter Descriptions>

Inspection item number	Specifies the inspection item number. (0 to 31)
Region number	Selects either a measurement region or a model registration region. The value that specifies each region differs according to the inspection item type. ^{*1}
Figure number	The measurement region or model registration region range registers a complicated model or a measurement region by combining a maximum of 8 figures (rectangles, circles, and other shapes). With this command, specify the figure number of the figure with the parameters you want to acquire out of the multiple figures.
Parameter 1 to parameter 21	The items of information for the figure set as the measurement region or the model registration region are split up and returned in parameter 1 through parameter 21. ^{*2}

*1 Depending on each inspection item type, the model registration region or measurement region is specified by the following values.

Inspection item types	Command arguments	
	Region number	Figure number
OCR	0 (measurement region)	0
Bar Code	0 (measurement region)	0
2D-code	0 (measurement region)	0
2D-code (DPM)	0 (measurement region)	0
Search	0 (model registration region)	0 to 7
	1 (measurement region)	0
Shape Search II	0 (model registration region)	0 to 7
	1 (measurement region)	0
Sensitive Search	0 (model registration region)	0 to 7
	1 (measurement region)	0
Edge Position	0 (measurement region)	0
Edge Width	0 (measurement region)	0
Edge Pitch	0 (measurement region)	0
Color Data	0 (measurement region)	0 to 7
Area	0 (measurement region)	0 to 7
Labeling	0 (measurement region)	0 to 7

*2 The information for the figure that is set as the model registration region or the measurement region is returned in the following manner for each figure type.

Figure type of specified figure number	Response parameters								
	Parameter 0	Parameter 1	Parameter 2	Parameter 3	Parameter 4	Parameter 5	...	Parameter 20	Parameter 21
Line with width	Figure type number (4: Line with width)	First X coordinate	First Y coordinate	Second X coordinate	Second Y coordinate	Line width	...	---	---
Rectangle	Figure type number (8: Rectangle)	Rectangle upper-left X coordinate	Rectangle upper-left Y coordinate	Rectangle lower-right X coordinate	Rectangle lower-right Y coordinate	---	---	---	---
Oval	Figure type number (16: Oval)	Oval center point X coordinate	Oval center point Y coordinate	Oval X-direction radius	Oval Y-direction radius	---	---	---	---
Circle with width	Figure type number (64: Circle with width)	Circle center point X coordinate	Circle center point Y coordinate	Circle radius	Width	---	---	---	---
Polygon	Figure type number (512: polygon)	Number of vertices	Vertex 1 X coordinate	Vertex 1 Y coordinate	Vertex 2 X coordinate	Vertex 2 Y coordinate	---	Vertex 10 X coordinate	Vertex 10 Y coordinate

GETPOSFIGPARAM or GPF

Acquire Measurement Region/Model Region Information Set for an Image Adjustment Item (Filter Item/Position Compensation Item)

This command acquires the parameters for the measurement region or the model registration region set for an image adjustment item (filter item/position compensation item).

Note

To check the figure number to be used when specifying a figure to change the settings of with the Set Image Adjustment Item Figure command, do so using this command.

<Command Format>

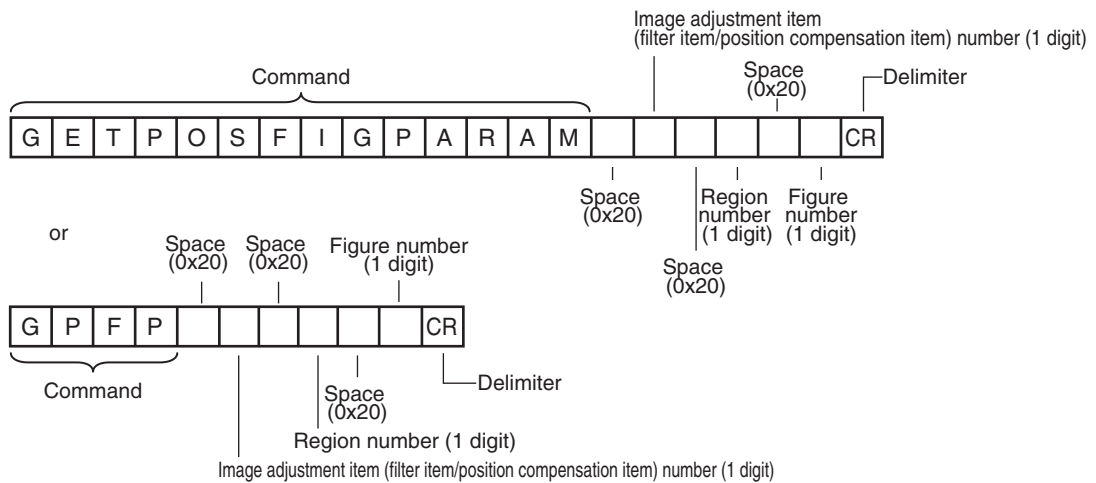

<Response Format>

When the Command Is Processed Normally

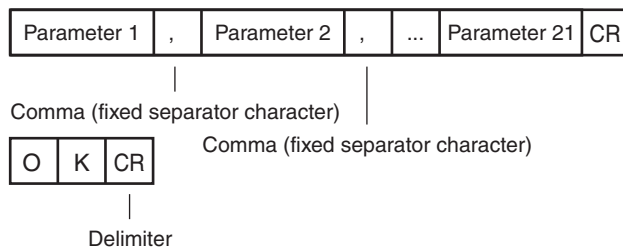

When the Command Is Not Processed Normally

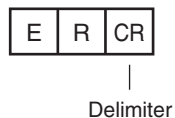

<Parameter Descriptions>

Image adjustment item (filter item/position compensation item) number	Specifies the image adjustment item (filter item/position compensation item) number. (0 to 7)
Region number	Selects the regions. The value that specifies each region differs according to the image adjustment item (filter item/position compensation item) type.*1
Figure number	The measurement region or model registration region range registers a complicated model or a measurement region by combining a maximum of 8 figures (rectangles, circles, and other shapes). With this command, specify the figure number of the figure with the parameters you want to acquire out of the multiple figures.
Parameter 1 to parameter 21	The items of information for the figure set as the model registration region or the measurement region are split up and returned in parameter 1 through parameter 21.*2

*1 The regions are specified with the following values according to the image adjustment item (filter item/position compensation item) type.

Image adjustment item (filter item/position compensation item) type	Command arguments	
	Region number	Figure number
Color Gray Filter	0 (Filter region)	0
Weak Smoothing	0 (Filter region)	0
Strong Smoothing	0 (Filter region)	0
Dilate	0 (Filter region)	0
Erosion	0 (Filter region)	0
Median	0 (Filter region)	0
Edge Extraction	0 (Filter region)	0
Extract Horizontal Edges	0 (Filter region)	0
Extract Vertical Edges	0 (Filter region)	0
Enhance Edges	0 (Filter region)	0
Background Suppression	0 (Filter region)	0
	1 (Background suppression calculation region)	0
Shape Search Position Compensation	0 (Position compensation region)	0
	1 (model registration region)	0 to 7
	2 (measurement region)	0
Search Position Compensation	0 (Position compensation region)	0
	1 (model registration region)	0 to 7
	2 (measurement region)	0
Edge Position Compensation	0 (measurement region)	0
	2 (Position compensation region)	0

Image adjustment item (filter item/position compensation item) type	Command arguments	
	Region number	Figure number
Two-edge Position Compensation	0 (Edge 1 measurement region)	0
	1 (Edge 2 measurement region)	0
	3 (Position compensation region)	0
Two-edge Midpoint Compensation	0 (Edge 1 measurement region)	0
	1 (Edge 2 measurement region)	0
	3 (Position compensation region)	0
Edge Rotation Position Compensation	0 (Edge 1 measurement region)	0
	1 (Edge 2 measurement region)	0
	3 (Position compensation region)	0

*2 The information for the figure that is set as each region is returned in the following manner for each figure type.

Figure type of specified figure number	Response parameters								
	Parameter 0	Parameter 1	Parameter 2	Parameter 3	Parameter 4	Parameter 5	...	Parameter 20	Parameter 21
Line with width	Figure type number (4: Line with width)	First X coordinate	First Y coordinate	Second X coordinate	Second Y coordinate	Line width	...	---	---
Rectangle	Figure type number (8: Rectangle)	Rectangle upper-left X coordinate	Rectangle upper-left Y coordinate	Rectangle lower-right X coordinate	Rectangle lower-right Y coordinate	---	---	---	---
Oval	Figure type number (16: Oval)	Oval center point X coordinate	Oval center point Y coordinate	Oval X-direction radius	Oval Y-direction radius	---	---	---	---
Circle with width	Figure type number (64: Circle with width)	Circle center point X coordinate	Circle center point Y coordinate	Circle radius	Width	---	---	---	---
Polygon	Figure type number (512: polygon)	Number of vertices	Vertex 1 X coordinate	Vertex 1 Y coordinate	Vertex 2 X coordinate	Vertex 2 Y coordinate	---	Vertex 10 X coordinate	Vertex 10 Y coordinate

GETDICFIGPARAM or GDFP

Acquire Dictionary Data Cutout Region Parameters

This command acquires the specified dictionary data cutout region parameters.

<Command Format>

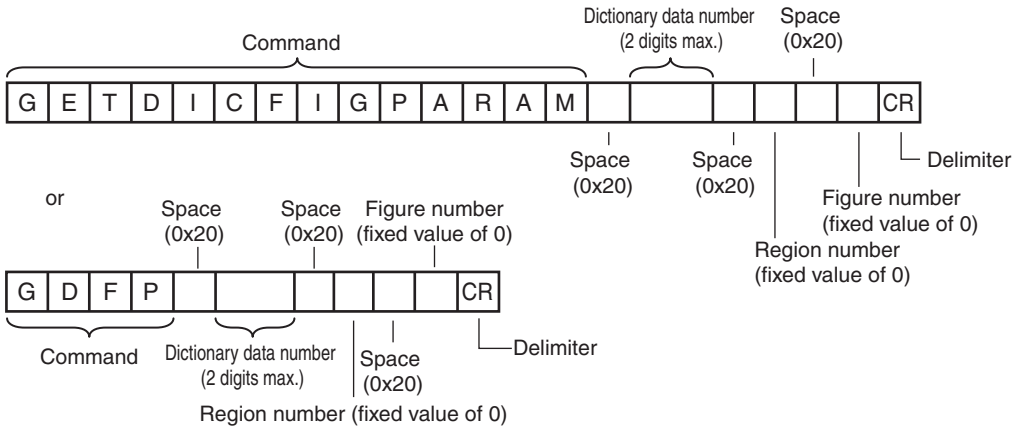

<Response Format>

When the Command Is Processed Normally

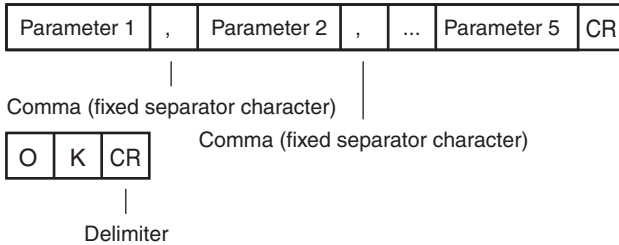

When the Command Is Not Processed Normally

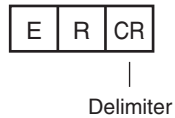

<Parameter Descriptions>

Dictionary data number	Specifies the dictionary data number. (0 to 31)
Region number	With the FQ2, specify 0.
Figure number	With the FQ2, specify 0.
Parameter 1 to parameter 5	The items of information for the dictionary data cutout region are split up and returned in parameter 1 through parameter 5.

* The dictionary data cutout region figure parameters are the upper-left coordinates and the lower-right coordinates of the rectangle.

	Name	Data type	Upper/lower limit value
Parameter 1	Figure types	Integer type	With the FQ2, fixed value of 8.
Parameter 2	Rectangle upper-left X coordinate		
Parameter 3	Rectangle upper-left Y coordinate		
Parameter 4	Rectangle lower-right X coordinate		
Parameter 5	Rectangle lower-right Y coordinate		

INPUTTRANSSTATE or ITS

Acquire Communication Input Status

This command acquires the input status (allowed/prohibited) for the communications protocol set with the Set Communication Input Status command.

<Command Format>

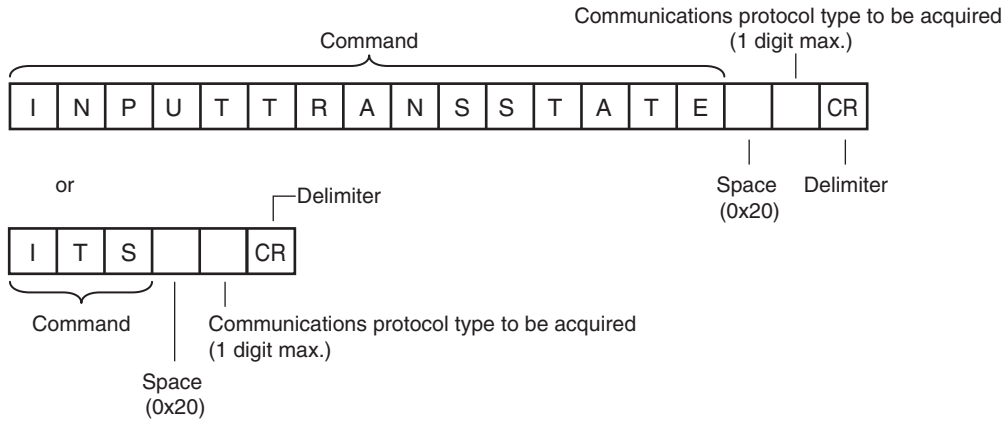

<Response Format>

When the Command Is Processed Normally

Acquired value	CR
----------------	----

O	K	CR
---	---	----

Delimiter

When the Command Is Not Processed Normally

E	R	CR
---	---	----

Delimiter

<Parameter Descriptions>

Communications protocol type to be acquired	Specifies the communications protocol type to be acquired. 0: No protocol (TCP, UDP, FINS) 1: No protocol (RS-232C) 2: Parallel I/O 3: Fieldbus 5: PLC link
Acquired value	Returns the acquired communications protocol status. 0: Input prohibited status 1: Input allowed status

ITEMDATA or ID

Acquire Inspection Item Data

This command acquires the parameters of the specified inspection item.

<Command Format>

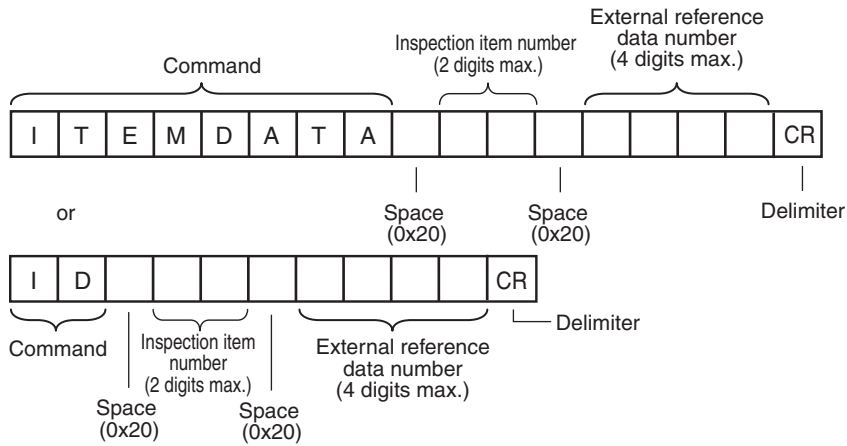

<Response Format>

When the Command Is Processed Normally

Acquired value CR

OK CR

Delimiter

When the Command Is Not Processed Normally

ER CR

Delimiter

<Parameter Descriptions>

Inspection item number	Specifies the inspection item number. (0 to 31)
External reference data number	Specifies the external reference data number. (0 to 9999) Section 9-2 External Reference Parameters in Vision Sensor FQ2-S/CH Series User's Manual (Cat. No. Z337)
Acquired value	Returns the data for the specified inspection item. Section 9-2 External Reference Parameters in Vision Sensor FQ2-S/CH Series User's Manual (Cat. No. Z337)

ITEMDATA2 command or ID2

Acquire Inspection Item Text String Data

This command acquires the text string data of the specified inspection item.

<Command Format>

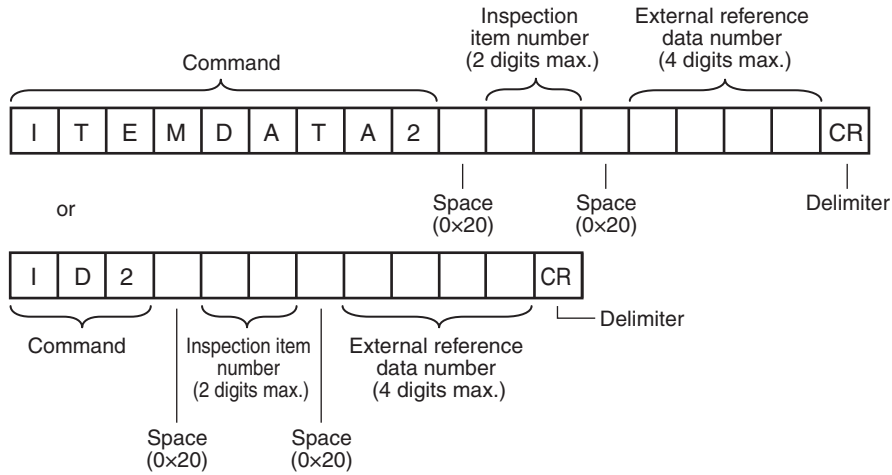

<Response Format>

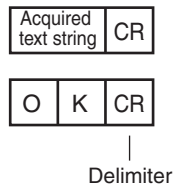

When the Command Is Processed Normally

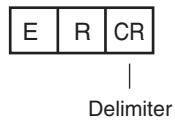

When the Command Is Not Processed Normally



<Parameter Descriptions>

Inspection item number	Specifies the inspection item number. (0 to 31)
External reference data number	Specifies the external reference data number.  Section 9-2 External Reference Parameters in Vision Sensor FQ2-S/CH Series User's Manual (Cat. No. Z337)
Acquired text string	Returns the text string data for the specified inspection item.  Section 9-2 External Reference Parameters in Vision Sensor FQ2-S/CH Series User's Manual (Cat. No. Z337)

MODE

Acquire Execution Mode

Acquires the FQ2 execution status (execution mode).

<Command Format>

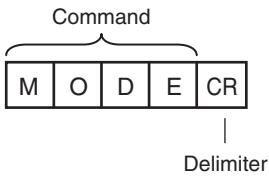

<Response Format>

When the Command Is Processed Normally

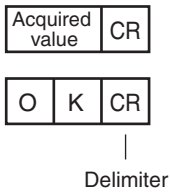

When the Command Is Not Processed Normally

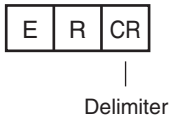

<Parameter Descriptions>

Acquired value	This command acquires the FQ2 execution mode*. 1: Run mode 2: Stop mode 10: Adjust mode 11: IO monitor setup mode
----------------	---

- * The execution mode is classified into the following modes depending on the FQ2 execution status.
- Run mode: The mode to run actual measurements. I/O is possible with external devices such as a PLC.
 - Stop mode: This mode is for monitoring/controlling the output status of the parallel signals through communication commands only. Therefore, I/O that is unrelated to parallel terminal control is not possible.
 - Input: Parallel signal input is not possible. Command input is not possible. (However, the terminal status monitor, setting commands can be used)
 - Output: Parallel signal output is possible. Data output is not possible.
 - Adjust mode: The status where Touch Finder is connected and the Setup display is displayed. This mode is for configuring settings and making adjustments, so measurement processing, I/O signals from external devices, and command input are not possible.
 - IO monitor setup mode: The status where Touch Finder is connected and the IO monitor in the Setup display is displayed.

OUTPUTTRANSSTATE or OTS

Acquire Communication Output Status

This command acquires the output status (allowed/prohibited) for all the communications protocol set with the Set Communication Output Status command.

<Command Format>

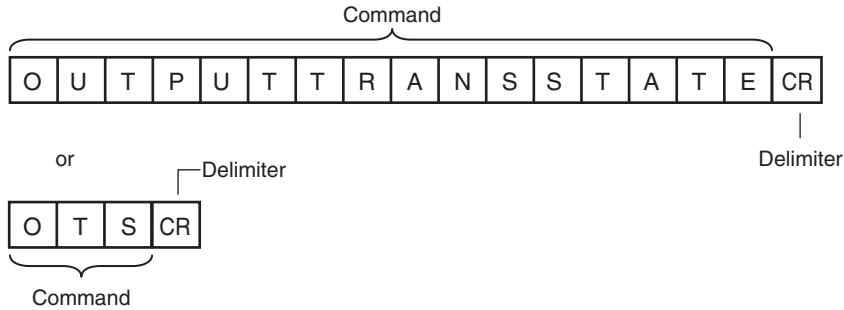

<Response Format>

When the Command Is Processed Normally

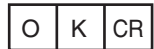

Delimiter

When the Command Is Not Processed Normally



Delimiter

<Parameter Descriptions>

Acquired value	Returns the acquired communications protocol status. 0: Output prohibited status 1: Output allowed status
----------------	---

PARAALLCOND or PAC

Batch Acquire Terminal Statuses

Batch acquires the ON/OFF status for the all parallel I/O input terminals other than the IN terminals.

<Command Format>

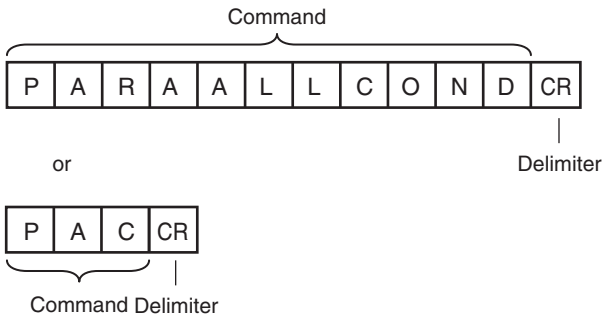

<Response Format>

When the Command Is Processed Normally

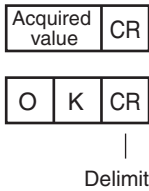

When the Command Is Not Processed Normally

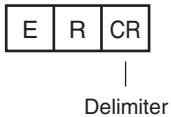

<Parameter Descriptions>

Acquired value	<p>Returns the acquired terminal status. (ON: 1, OFF: 0) (0 to 31)</p> <p>BIT0: TRIG BIT1: DSA BIT4: RESET</p> <p>For example, when DSA is ON 2 is returned.</p>
----------------	---

PARAPORTCOND or PPC

Acquire Terminal Status

Acquires the input signal ON/OFF status for the specified parallel I/O terminal.

<Command Format>

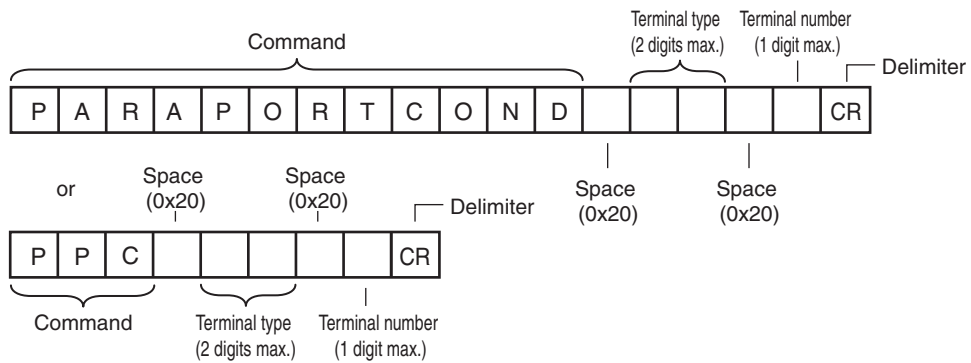

<Response Format>

When the Command Is Processed Normally

Acquired value	CR
----------------	----

O	K	CR
---	---	----

Delimiter

When the Command Is Not Processed Normally

E	R	CR
---	---	----

Delimiter

<Parameter Descriptions>

Terminal type	<p>Specifies the type of terminal for the terminal status to be acquired.</p> <ul style="list-style-type: none">• Sensor's standard parallel communications 0: TRIG 2: IN0 to IN5• Parallel Interface Sensor Data Unit 0: TRIG 1: DSA 2: IN0 to IN7 13: RESET• RS-232C Interface Sensor Data Unit 0: TRIG 2: IN0 to IN5 13: RESET
Terminal number	<p>Specifies the terminal number for the terminal status to be acquired.</p> <ul style="list-style-type: none">• If the terminal type is IN0 to IN5 0: IN0 to 5: IN5• If the terminal type is IN0 to IN7 0: IN0 to 7: IN7• Cases other than the above cases Specify 0
Acquired value	<p>Returns the acquired terminal status. (ON: 1, OFF: 0)</p>

POSITIONDATA or PD

Get Image Adjustment Data

This command acquires parameters from a position compensation item or filter item.

<Command Format>

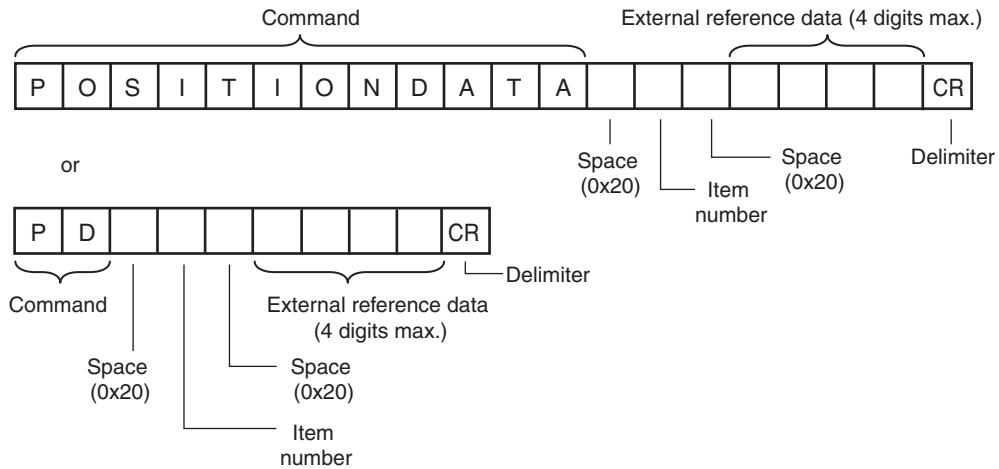

<Response Format>

When the Command Is Processed Normally

Acquired value	CR
----------------	----

O	K	CR
---	---	----

Delimiter

When the Command Is Not Processed Normally

E	R	CR
---	---	----

Delimiter

<Parameter Descriptions>

Item number	Specifies the item number of the position compensation item or of the filter item.
External reference data number	Specifies the external reference data number. Section 9-2 External Reference Parameters in Vision Sensor FQ2-S/CH Series User's Manual (Cat. No. Z337)
Acquired value	Returns the image adjustment data or threshold value. Section 9-2 External Reference Parameters in Vision Sensor FQ2-S/CH Series User's Manual (Cat. No. Z337)

REGIMAGE or RID

Acquire Registered Image

This command loads a registered image saved to the SD card or PC Tool as the measurement image. The registered image is the latest image or a logging image that has been assigned a number between 0 and 999 and has been registered in advance with the Set a Registered Image command.

 Set a Registered Image p.271

<Command Format>

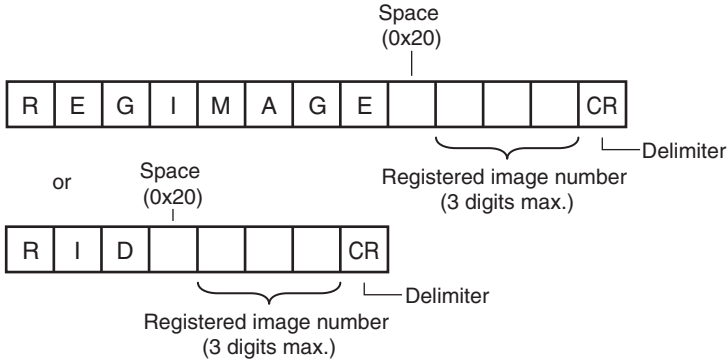

<Response Format>

When the Command Is Processed Normally

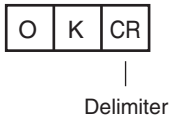

When the Command Is Not Processed Normally

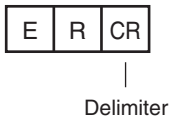

<Parameter Descriptions>

Registered image number	Specifies the image to be loaded as the measurement image. The image is registered in advance with the Set a Registered Image command and assigned a number. (0 to 999)
-------------------------	---

SYSDATA or SD

Acquire System Data

This command acquires the value set for the specified system data.

 System data numbers and details: p. 222

<Command Format>

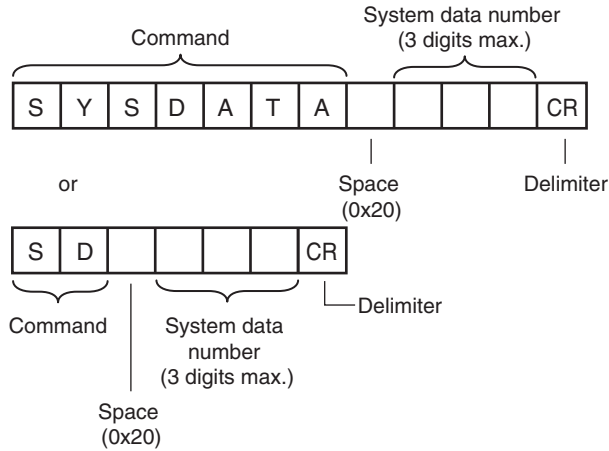

<Response Format>

When the Command Is Processed Normally

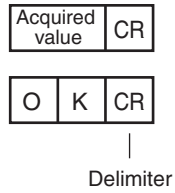

When the Command Is Not Processed Normally

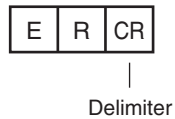

<Parameter Descriptions>

System data number	Specifies the number that corresponds to the system data to be acquired.
Acquired value	Returns the specified system data.

TOTALDATA or TD

Acquire Statistical Data

Acquires the statistical data (such as the number of measurements, number of NG overall judgments, and other information, since the power supply was turned ON) possessed by the Sensor.

The following types of statistical data are available. Specify the data to be read from these types with this command.

- Number of measurements since the power supply was turned ON
- Number of OK overall judgments
- NG rate
- Number of NG judgments since the power supply was turned ON
- OK rate

<Command Format>

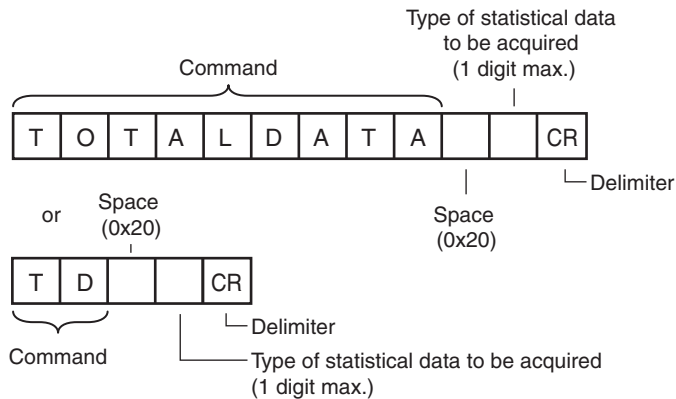

<Response Format>

When the Command Is Processed Normally

Acquired value CR

OK CR

Delimiter

When the Command Is Not Processed Normally

ER CR

Delimiter

<Parameter Descriptions>

Type of statistical data to be acquired	Specifies the type of statistical data to be acquired. 1: Number of measurements 2: Number of NG judgments 3: NG rate 4: Number of OK judgments 5: OK rate
Acquired value	Returns the value of the acquired statistical data.

VERGET

Acquire Software Version

This command acquires the version information of the Sensor software.

<Command Format>

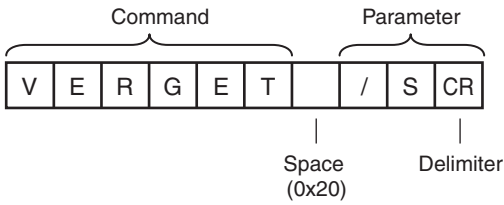

<Response Format>

When the Command Is Processed Normally

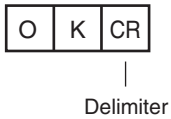
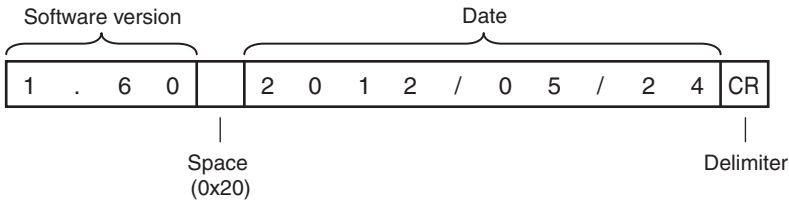

When the Command Is Not Processed Normally

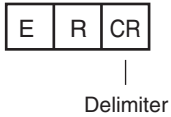

<Parameter Descriptions>

Software version	Returns the software version. Example: When the software version is 1.60, the response is 1.60.
Date	Returns the date. Example: When the date is 13 May 2012, the response is 2012/05/13.

Acquire Sensor Model

This command acquires the Sensor model.

<Command Format>

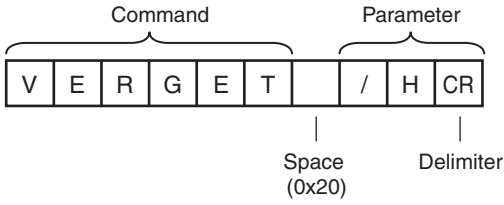

<Response Format>

When the Command Is Processed Normally

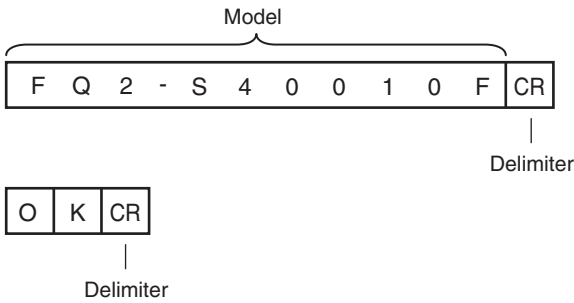

When the Command Is Not Processed Normally

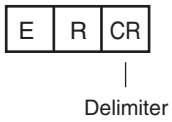

<Parameter Descriptions>

Model	Returns the model. Example: When the model is FQ2-S40010F, the response is FQ2-S40010F.
-------	--

Commands to Write Data

CAMDATA or CD

Set Camera Parameter

Sets the value for the specified camera parameter.

 Camera parameter numbers: p. 219

<Command Format>

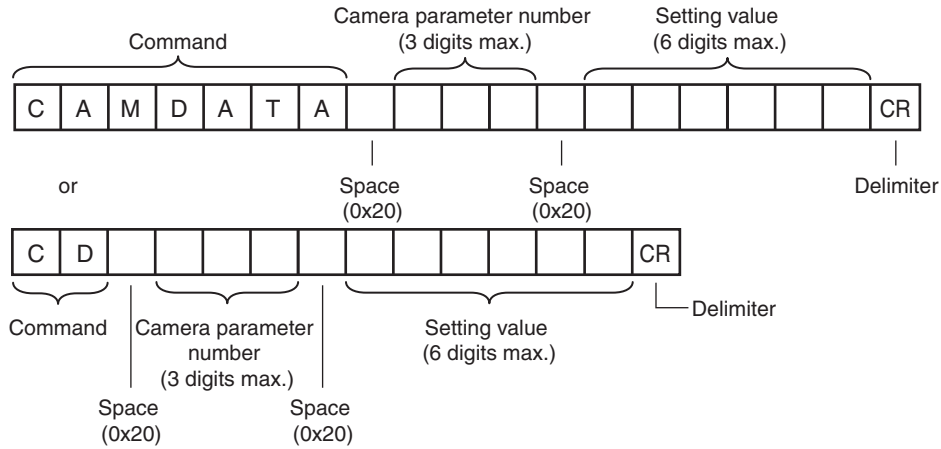

<Response Format>

When the Command Is Processed Normally

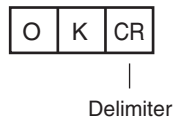

When the Command Is Not Processed Normally

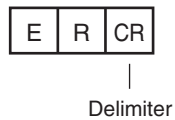

<Parameter Descriptions>

Camera parameter number*	Specifies the number that corresponds to the camera parameter to be set.
Setting value	Specifies the setting value to be set to the camera parameter.

DIOFFSET or DIO

Set Terminal Offset Data

This command sets the value of the terminal offset data that is added to the IN0 to IN4 command parameters when executing parallel commands.

When using parallel command scene changing, you can change the scenes to change to by changing the Set Terminal Offset Data value.

<Command Format>

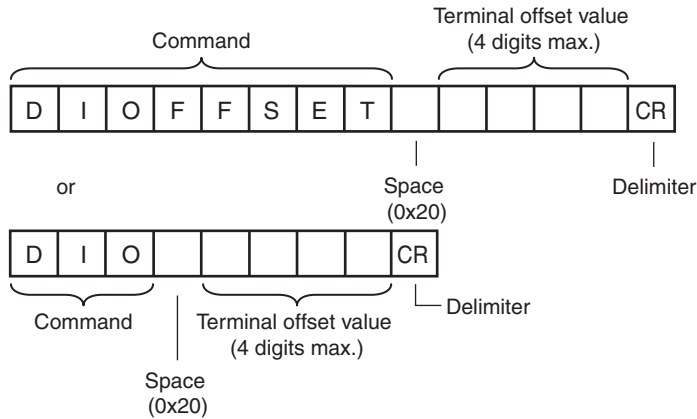

<Response Format>

When the Command Is Processed Normally

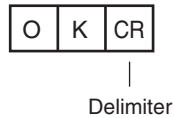

When the Command Is Not Processed Normally

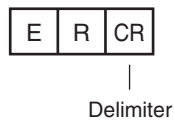

<Parameter Descriptions>

Terminal offset value	Specifies the value to be added to the IN0 to IN4 command parameters when executing parallel commands. When using the Sensor in Expanded Mode while using the standard parallel interface of the Sensor, the range of scene numbers that can be changed to with scene changing is limited to 0 through 15. By offsetting the command parameter, the scene can be changed to scene number 0 through 31.
-----------------------	---

DOPORTCOND or DPC

Batch Set D Terminal Statuses

Batch sets the ON/OFF status for the D terminals (D0 to D15).

Important

Before executing this command, change the FQ2 execution mode to stop mode with the Set Execution Mode command.

 Set Execution Mode: p.321

<Command Format>

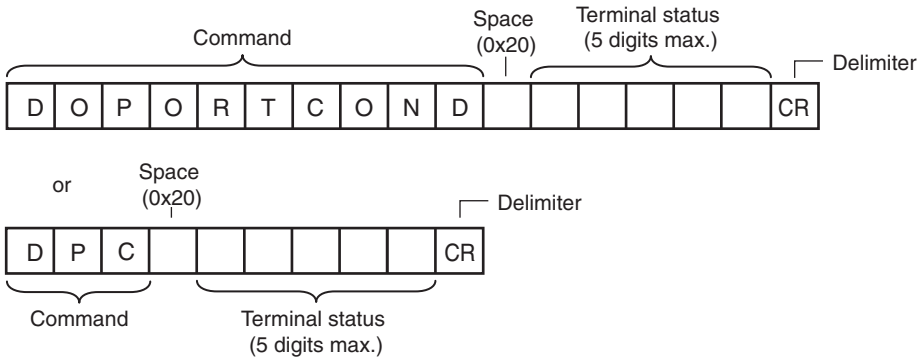

<Response Format>

When the Command Is Processed Normally

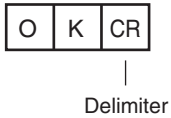

When the Command Is Not Processed Normally

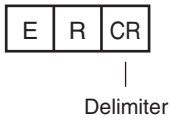

<Parameter Descriptions>

Terminal status	Specifies the ON/OFF status for the terminals as a hexadecimal value. (ON: 1, OFF: 0) (0 to 65,535) BIT0: D0 BIT1: D1 BIT2: D2 BIT3: D3 BIT4: D4 BIT5: D5 BIT6: D6 BIT7: D7 BIT8: D8 BIT9: D9 BIT10: D10 BIT11: D11 BIT12: D12 BIT13: D13 BIT14: D14 BIT15: D15 For example, to turn ON D0 and D4 Specify 17.
-----------------	--

INPUTTRANSSTATE or ITS

Set Communication Input Status

This command sets the input status (allowed/prohibited) of the communications port for the specified communications protocol.

Communications protocols with the input status set to prohibited will no longer receive communications after being set as such.

However, for inputs related to hardware (parallel TRIG signal and DSA signal), this setting is not applicable.

<Command Format>

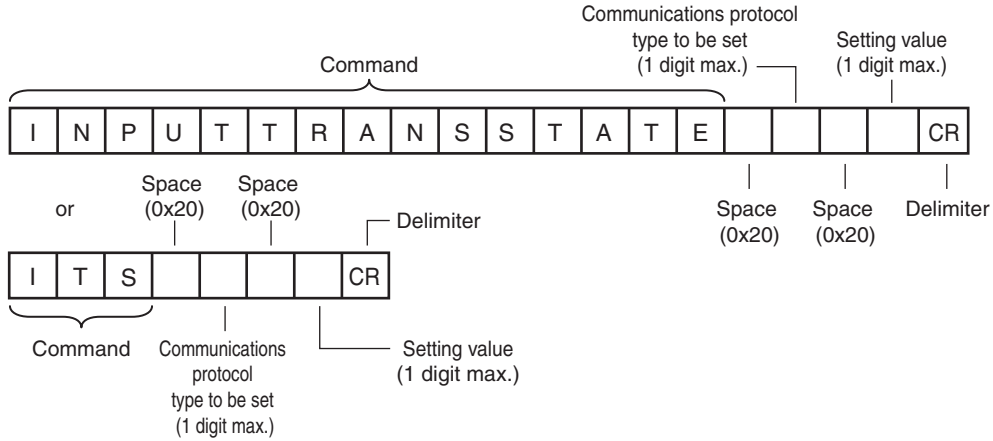

<Response Format>

When the Command Is Processed Normally

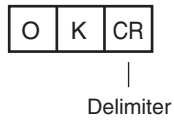

When the Command Is Not Processed Normally

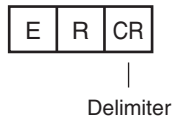

<Parameter Descriptions>

Communications protocol type to be set	Specifies the type of communications protocol to be set. 0: No protocol (TCP, UDP, FINS) 1: No protocol (RS-232C) 2: Parallel I/O 3: Fieldbus 5: PLC link
Setting value	Sets the status of the communications protocol. 0: Input prohibited status 1: Input allowed status

DICDELETE or DD

Delete One Character from Dictionary Data

This command deletes one character from the characters registered in the model dictionary.

<Command Format>

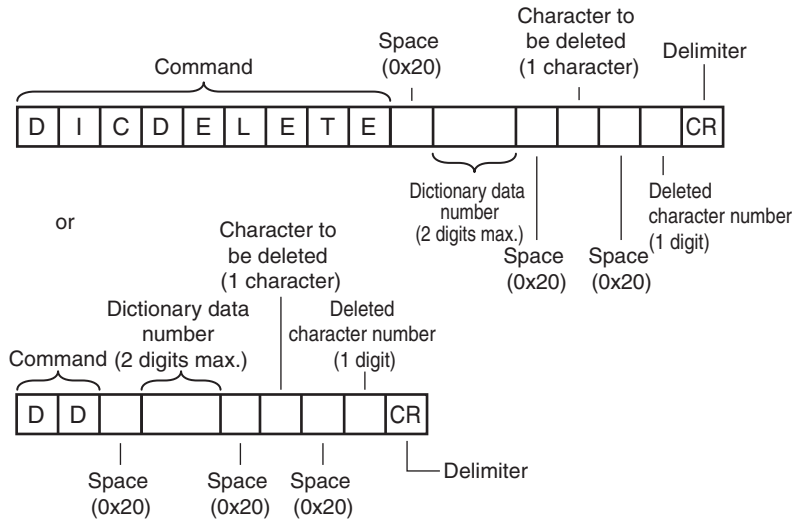

<Response Format>

When the Command Is Processed Normally

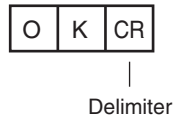

When the Command Is Not Processed Normally

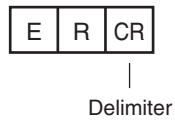

<Parameter Descriptions>

Dictionary data number	Specifies the dictionary data number. (0 to 31)
Character to be deleted	Character to be deleted (1 character)
Deleted character number	Deleted character number 0 to 9: Registration number assigned to the character -1: Delete all registered characters

DICREGIST or DR

Register Characters to Dictionary Data

This command registers characters to the specified dictionary data.

<Command Format>

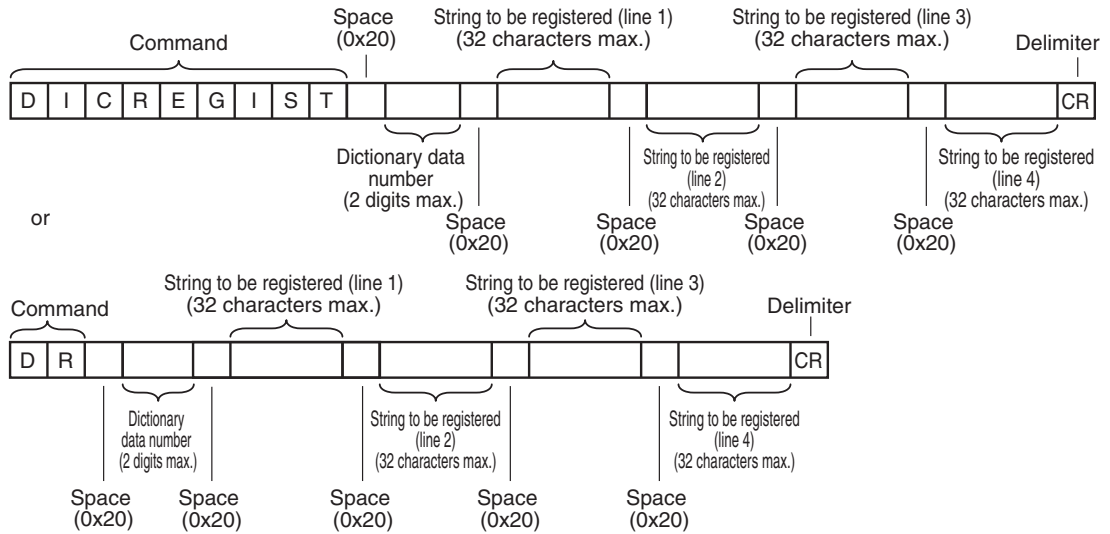

<Response Format>

When the Command Is Processed Normally

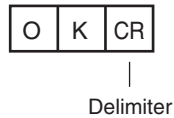

When the Command Is Not Processed Normally

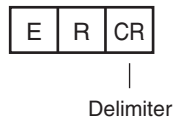

<Parameter Descriptions>

Dictionary data number	Specifies the dictionary data number. (0 to 31)
String to be registered (line 1)	String to be registered (1 to 32 characters) Specify the strings from line 1 to line 4 according to the character format.
String to be registered (line 2)	
String to be registered (line 3)	
String to be registered (line 4)	

SETITEMFIGPARAM or SIFP

Set Inspection Item Measurement Region/Model Region

This command changes the range set as the measurement region or the model registration region for an inspection item.

This command cannot set a new measurement region or model registration region.

When using this command, execute it for an inspection item that has already been set with a measurement region or a model registration region.

<Command Format>

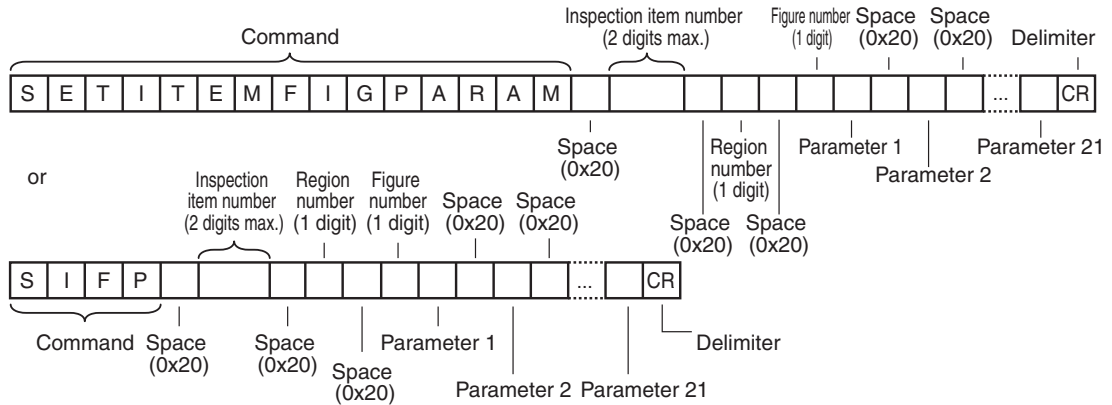

<Response Format>

When the Command Is Processed Normally

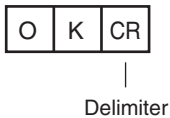

When the Command Is Not Processed Normally

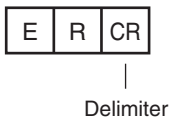

<Parameter Descriptions>

Inspection item number	Specifies the inspection item number. (0 to 31)
Region number	Selects either a measurement region or a model registration region. The value that specifies each region differs according to the inspection item type. ^{*1}
Figure number	The measurement region or model registration region range registers a complicated model or a measurement region by combining a maximum of 8 figures (rectangles, circles, and other shapes). Of those figures, specify the figure to change the range of using this command with the figure number. ^{*1} Use the Acquire Inspection Item Figure command to check the figure numbers assigned to each figure in advance.  Acquire Measurement Region/Model Region Information Set for an Inspection Item: p. 283
Parameter 1 to parameter 21	The values to be set as the measurement region or the model registration region are split up and specified in parameter 1 through parameter 21. ^{*2}

*1 Depending on each inspection item type, the model registration region or measurement region is specified by the following values.

Inspection item types	Command arguments	
	Region number	Figure number
OCR	0 (measurement region)	0
Bar Code	0 (measurement region)	0
2D-code	0 (measurement region)	0
2D-code (DPM)	0 (measurement region)	0
Search	0 (model registration region)	0 to 7
	1 (measurement region)	0
Shape Search II	0 (model registration region)	0 to 7
	1 (measurement region)	0
Sensitive Search	0 (model registration region)	0 to 7
	1 (measurement region)	0
Edge Position	0 (measurement region)	0
Edge Width	0 (measurement region)	0
Edge Pitch	0 (measurement region)	0
Color Data	0 (measurement region)	0 to 7
Area	0 (measurement region)	0 to 7
Labeling	0 (measurement region)	0 to 7

*2 Specify the setting value for the figure that is to be set as the model registration region or the measurement region in the following manner for each figure type.

Figure type of specified figure number	Response parameters								
	Parameter 0	Parameter 1	Parameter 2	Parameter 3	Parameter 4	Parameter 5	...	Parameter 20	Parameter 21
Line with width	Figure type number (4: Line with width)	First X coordinate	First Y coordinate	Second X coordinate	Second Y coordinate	Line width	...	---	---
Rectangle	Figure type number (8: Rectangle)	Rectangle upper-left X coordinate	Rectangle upper-left Y coordinate	Rectangle lower-right X coordinate	Rectangle lower-right Y coordinate	---	---	---	---
Oval	Figure type number (16: Oval)	Oval center point X coordinate	Oval center point Y coordinate	Oval X-direction radius	Oval Y-direction radius	---	---	---	---
Circle with width	Figure type number (64: Circle with width)	Circle center point X coordinate	Circle center point Y coordinate	Circle radius	Width	---	---	---	---
Polygon	Figure type number (512: polygon)	Number of vertices	Vertex 1 X coordinate	Vertex 1 Y coordinate	Vertex 2 X coordinate	Vertex 2 Y coordinate	---	Vertex 10 X coordinate	Vertex 10 Y coordinate

SETPOSFIGPARAM or SPFP

Set Measurement Region/Model Region for an Image Adjustment Item (Filter Item/Position Compensation Item)

This command changes the range set as the measurement region or the model registration region for an image adjustment item (filter item/position compensation item).

This command cannot set a new measurement region or model registration region.

When using this command, execute it for an inspection item that has already been set with a measurement region or a model registration region.

<Command Format>

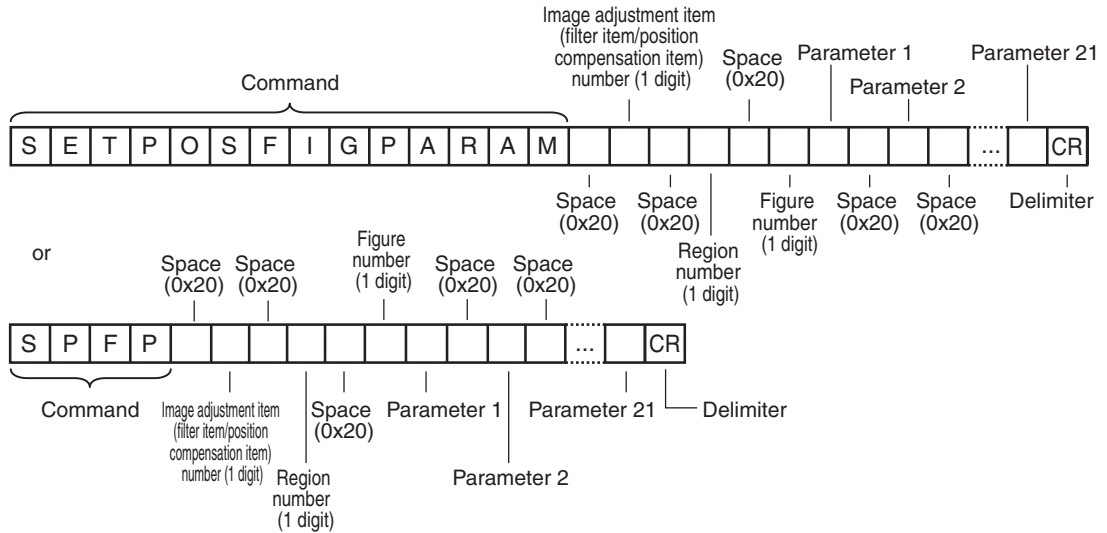

<Response Format>

When the Command Is Processed Normally

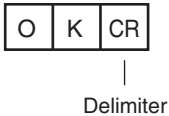

When the Command Is Not Processed Normally

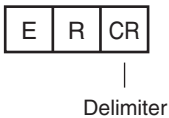

<Parameter Descriptions>

Image adjustment item (filter item/position compensation item) number	Specifies the image adjustment item (filter item/position compensation item) number. (0 to 7)
Region number	Selects the regions. The value that specifies each region differs according to the image adjustment item (filter item/position compensation item) type.* ¹
Figure number	<p>The measurement region or model registration region range registers a complicated model or a measurement region by combining a maximum of 8 figures (rectangles, circles, and other shapes). Of those figures, specify the figure to change the range of using this command with the figure number. *¹ Use the Acquire Image Adjustment Item (Filter Item/Position Compensation Item) Figure command to check the figure numbers assigned to each figure in advance.</p> <p> Acquire Measurement Region/Model Region Information Set for an Image Adjustment Item (Filter Item/Position Compensation Item): p. 286</p>
Parameter 1 to parameter 21	The settings for the model registration region or the measurement region are split up and set in parameter 1 through parameter 21.* ²

*¹ The regions are specified with the following values according to the image adjustment item (filter item/position compensation item) type.

Image adjustment item (filter item/position compensation item) type	Command arguments	
	Region number	Figure number
Color Gray Filter	0 (Filter region)	0
Weak Smoothing	0 (Filter region)	0
Strong Smoothing	0 (Filter region)	0
Dilate	0 (Filter region)	0
Erosion	0 (Filter region)	0
Median	0 (Filter region)	0
Edge Extraction	0 (Filter region)	0
Extract Horizontal Edges	0 (Filter region)	0
Extract Vertical Edges	0 (Filter region)	0
Enhance Edges	0 (Filter region)	0
Background Suppression	0 (Filter region)	0
	1 (Background suppression calculation region)	0
Shape Search Position Compensation	0 (Position compensation region)	0
	1 (model registration region)	0 to 7
	2 (measurement region)	0
Search Position Compensation	0 (Position compensation region)	0
	1 (model registration region)	0 to 7
	2 (measurement region)	0

Image adjustment item (filter item/position compensation item) type	Command arguments	
	Region number	Figure number
Edge Position Compensation	0 (measurement region)	0
	2 (Position compensation region)	0
Two-edge Position Compensation	0 (Edge 1 measurement region)	0
	1 (Edge 2 measurement region)	0
	3 (Position compensation region)	0
Two-edge Midpoint Compensation	0 (Edge 1 measurement region)	0
	1 (Edge 2 measurement region)	0
	3 (Position compensation region)	0
Edge Rotation Position Compensation	0 (Edge 1 measurement region)	0
	1 (Edge 2 measurement region)	0
	3 (Position compensation region)	0

*2 The information for the figure that is set as each region is returned in the following manner for each figure type.

Figure type of specified figure number	Response parameters								
	Parameter 0	Parameter 1	Parameter 2	Parameter 3	Parameter 4	Parameter 5	...	Parameter 20	Parameter 21
Line with width	Figure type number (4: Line with width)	First X coordinate	First Y coordinate	Second X coordinate	Second Y coordinate	Line width	...	---	---
Rectangle	Figure type number (8: Rectangle)	Rectangle upper-left X coordinate	Rectangle upper-left Y coordinate	Rectangle lower-right X coordinate	Rectangle lower-right Y coordinate	---	---	---	---
Oval	Figure type number (16: Oval)	Oval center point X coordinate	Oval center point Y coordinate	Oval X-direction radius	Oval Y-direction radius	---	---	---	---
Circle with width	Figure type number (64: Circle with width)	Circle center point X coordinate	Circle center point Y coordinate	Circle radius	Width	---	---	---	---
Polygon	Figure type number (512: polygon)	Number of vertices	Vertex 1 X coordinate	Vertex 1 Y coordinate	Vertex 2 X coordinate	Vertex 2 Y coordinate	---	Vertex 10 X coordinate	Vertex 10 Y coordinate

SETDICFIGPARAM or SDFP

Set Dictionary Data Cutout Region Parameters

This command sets the specified dictionary data cutout region parameters.

<Command Format>

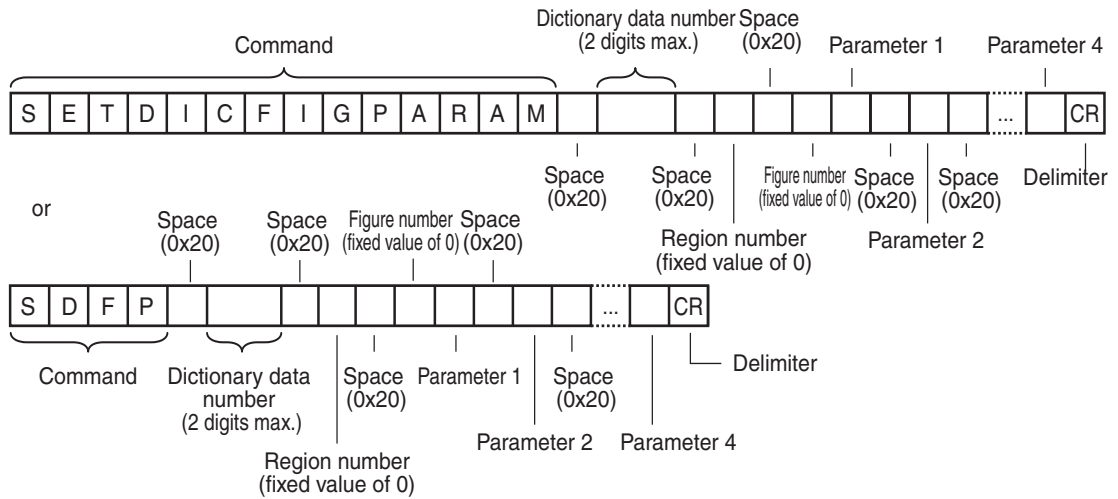

<Response Format>

When the Command Is Processed Normally

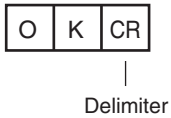

When the Command Is Not Processed Normally

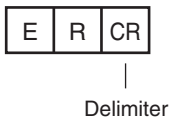

<Parameter Descriptions>

Dictionary data number	Specifies the dictionary data number. (0 to 31)
Region number	With the FQ2, specify 0.
Figure number	With the FQ2, specify 0.
Parameter 1 to parameter 4	The settings for the dictionary data cutout region are split up and set in parameter 1 through parameter 4.*

* The dictionary data cutout region figure parameters are the upper-left coordinates and the lower-right coordinates of the rectangle.

	Name	Data type
Parameter 1	Rectangle upper-left X coordinate	Integer type
Parameter 2	Rectangle upper-left Y coordinate	
Parameter 3	Rectangle lower-right X coordinate	
Parameter 4	Rectangle lower-right Y coordinate	

ITEMDATA Command or ID

Set Inspection Item Data

This command sets the parameters of the specified inspection item.

<Command Format>

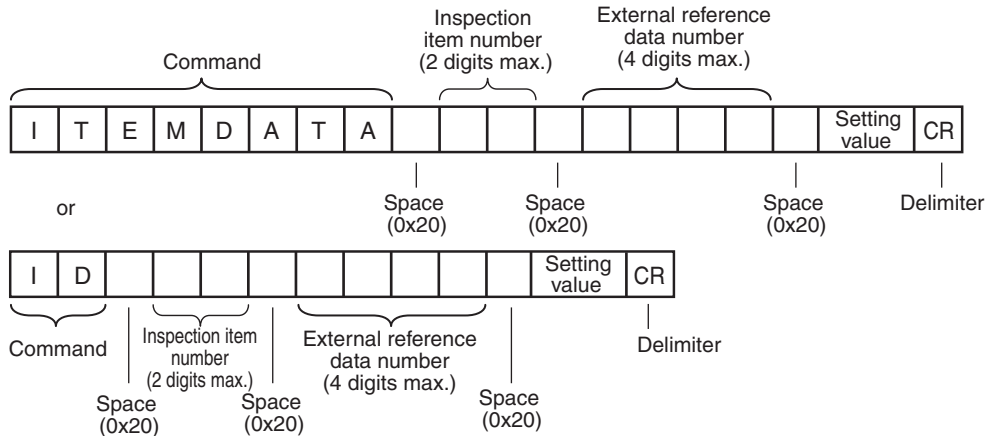

<Response Format>

When the Command Is Processed Normally

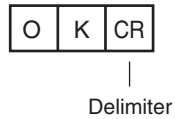

When the Command Is Not Processed Normally

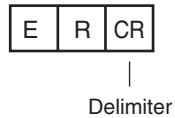

<Parameter Descriptions>

Inspection item number	Specifies the inspection item number. (0 to 31)
External reference data number	Specifies the external reference data number. (0 to 9999) Section 9-2 External Reference Parameters in Vision Sensor FQ2-S/CH Series User's Manual (Cat. No. Z337)
Setting value	Specifies the setting value. Section 9-2 External Reference Parameters in Vision Sensor FQ2-S/CH Series User's Manual (Cat. No. Z337)

ITEMDATA2 Command or ID2

Set Inspection Item Text String Data

This command sets the text string data for the specified inspection item.

<Command Format>

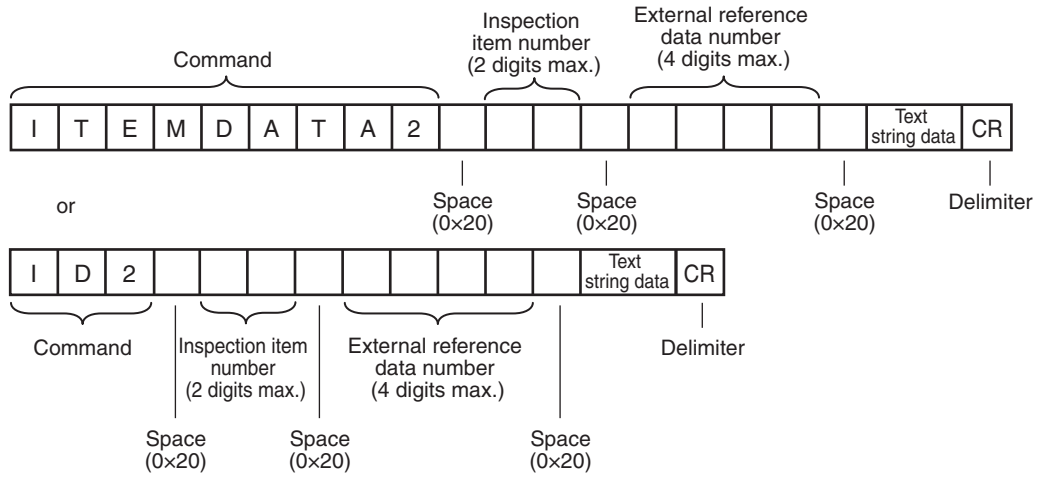

<Response Format>

When the Command Is Processed Normally

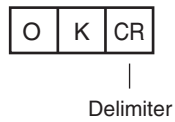

When the Command Is Not Processed Normally

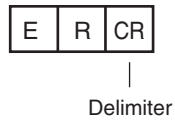

<Parameter Descriptions>

Inspection item number	Specifies the inspection item number. (0 to 31)
External reference data number	Specifies the external reference data number. Section 9-2 External Reference Parameters in Vision Sensor FQ2-S/CH Series User's Manual (Cat. No. Z337)
Text string data	Specifies the text string data for the specified inspection item. Section 9-2 External Reference Parameters in Vision Sensor FQ2-S/CH Series User's Manual (Cat. No. Z337)

MODE

Set Execution Mode

Sets the FQ2 execution status (execution mode).

Note

When using commands (Set Terminal Status/Batch Set Terminal Status/Batch Set DO Status) to control the ON/OFF status of the parallel I/O terminals with communication commands, change the FQ2 to stop mode with this command.

<Command Format>

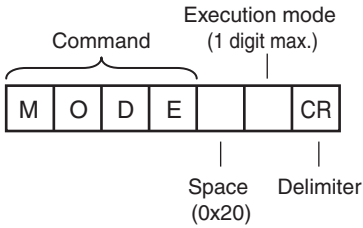

<Response Format>

When the Command Is Processed Normally

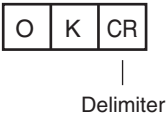

When the Command Is Not Processed Normally

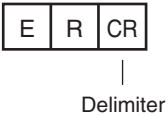

<Parameter Descriptions>

Execution mode	Specifies the FQ2 execution mode* to be set. 1: Run mode 2: Stop mode
----------------	---

* The execution mode is classified into the following modes depending on the FQ2 execution status.

- Run mode: The mode to run actual measurements. I/O is possible with external devices such as a PLC.
- Stop mode: This mode is for monitoring/controlling the output status of the parallel signals through communication commands only. Therefore, I/O that is unrelated to parallel terminal control is not possible.
 - Input: Parallel signal input is not possible. Command input is not possible. (However, the terminal status monitor, setting commands can be used)
 - Output: Parallel signal output is possible. Data output is not possible.

OUTPUTTRANSSTATE or OTS

Set Communication Output Status

This command sets the output status (allowed/prohibited) for all the communications protocol.

Communications protocols with the output status set to prohibited will no longer output signals after being set as such.

<Command Format>

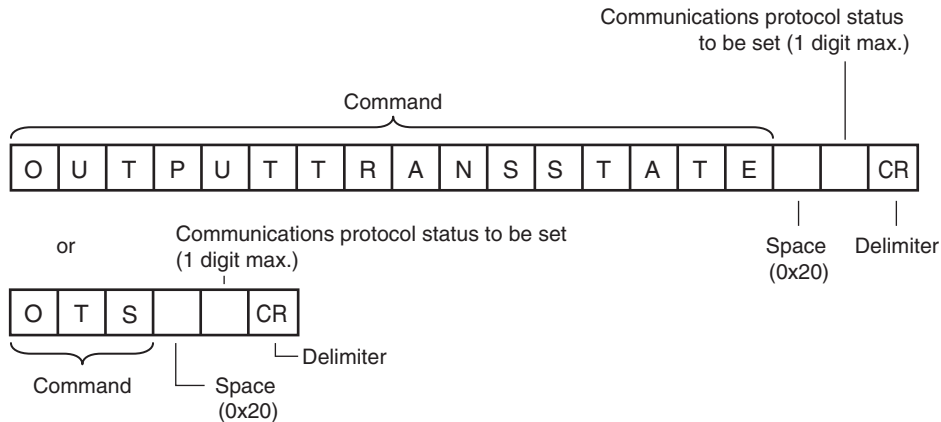

<Response Format>

When the Command Is Processed Normally

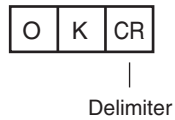

When the Command Is Not Processed Normally

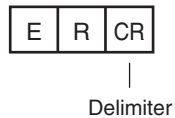

<Parameter Descriptions>

Communications protocol status to be set	Specifies the communications protocol status to be acquired. 0: Output prohibited status 1: Output allowed status
--	---

PARALLCOND or PAC

Batch Set Terminal Statuses

Batch sets the ON/OFF status for the all parallel I/O output terminals other than the D terminals (D0 to D15).

Important

- Before executing this command, change the FQ2 execution mode to stop mode with the Set Execution Mode command.
- If the FQ2 is not in stop mode, some parallel terminals cannot be turned ON or OFF with this command.

 Set Execution Mode p.267

<Command Format>

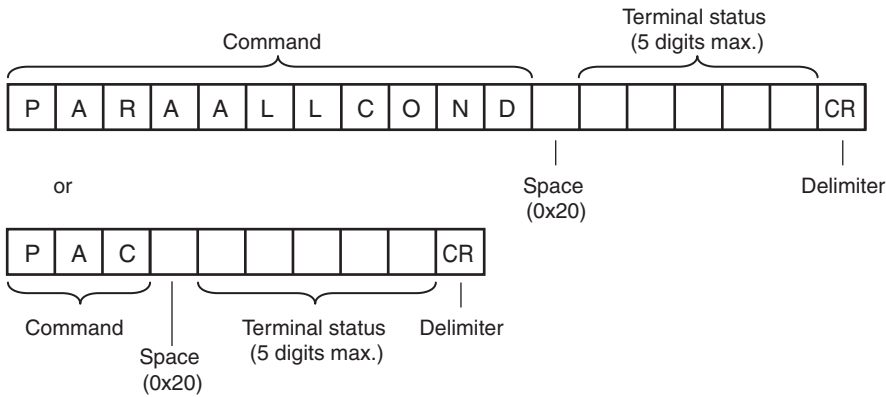

<Response Format>

When the Command Is Processed Normally

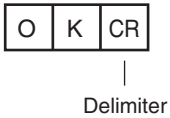

When the Command Is Not Processed Normally

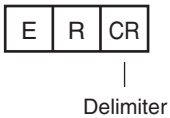

<Parameter Descriptions>

Terminal status	<p>Specifies the ON/OFF status for the terminal. (ON: 1, OFF: 0) (0 to 16,383)</p> <ul style="list-style-type: none"> • Sensor's standard parallel communications <ul style="list-style-type: none"> BIT1: ERROR BIT2: BUSY BIT3: OR • Parallel Interface Sensor Data Unit <ul style="list-style-type: none"> BIT0: RUN BIT1: ERROR BIT2: BUSY BIT3: OR^{*1} BIT5: GATE^{*1} BIT9: STGOUT^{*1} BIT11: SHTOUT^{*1} BIT13: ACK^{*1} • RS-232C Interface Sensor Data Unit <ul style="list-style-type: none"> BIT0: RUN BIT1: ERROR BIT2: BUSY BIT3: OR^{*1} BIT9: STGOUT^{*1} BIT11: SHTOUT^{*1} BIT13: ACK^{*1} <p>For example, to turn ON OR Specify 8.</p>
-----------------	--

*1 These terminals status can only be set when the FQ2 execution mode is stop mode.

PARAPORTCOND or PPC

Set Terminal Status

This command sets the output signal ON/OFF status for the specified parallel I/O terminal.

<Command Format>

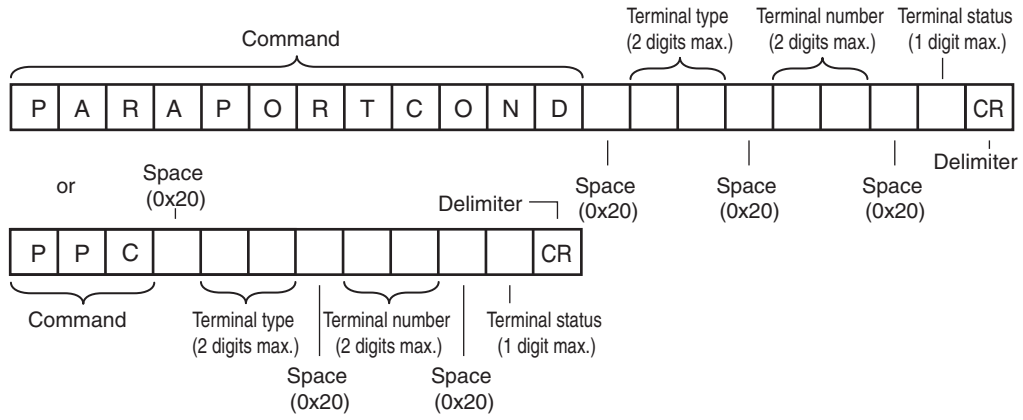

<Response Format>

When the Command Is Processed Normally

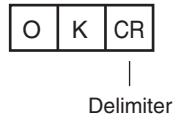

When the Command Is Not Processed Normally

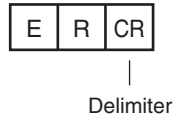

<Parameter Descriptions>

Terminal type	<p>Specifies the type of terminal for the terminal status to be set.</p> <ul style="list-style-type: none"> • Sensor's standard parallel communications <ul style="list-style-type: none"> 4: ERROR 5: BUSY 6: OR • Parallel Interface Sensor Data Unit <ul style="list-style-type: none"> 3: RUN 4: ERROR 5: BUSY 6: OR^{*1} 7: GATE^{*1} 9: D0 to D15^{*1} 10: STGOUT^{*1} 11: SHTOUT^{*1} 12: ACK^{*1} • RS-232C Interface Sensor Data Unit <ul style="list-style-type: none"> 3: RUN 4: ERROR 5: BUSY 6: OR^{*1} 10: STGOUT^{*1} 11: SHTOUT^{*1} 12: ACK^{*1}
Terminal number	<p>Specifies the terminal number for the terminal status to be set.</p> <p>If the terminal type is D0 to D15</p> <p>0: D0 to 15: D15</p> <p>Cases other than the above cases</p> <p>Specify 0</p>
Terminal status	<ul style="list-style-type: none"> • Specifies the ON/OFF status for the terminal. <p>0: OFF</p> <p>1: ON</p>

*1 These terminals status can only be set when the FQ2 execution mode is stop mode.

POSITIONDATA or PD

Set Image Adjustment Data

This command sets parameters from a position compensation item or filter item.

<Command Format>

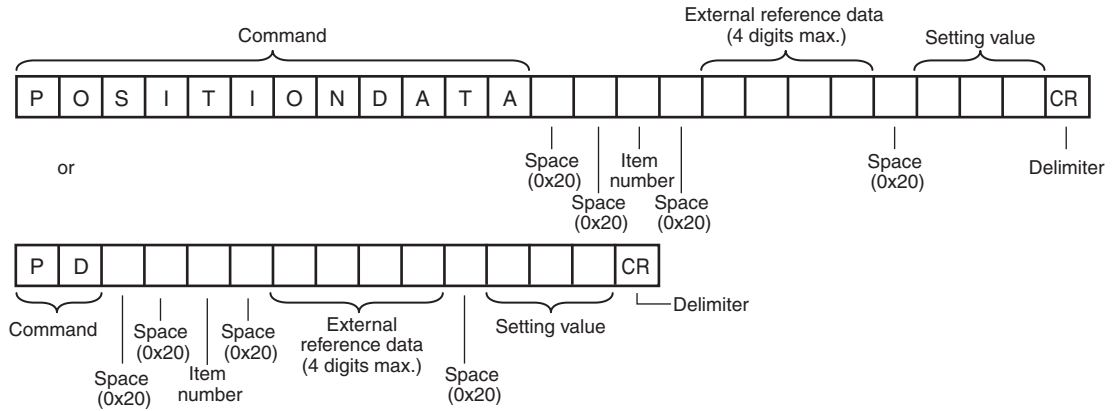

<Response Format>

When the Command Is Processed Normally

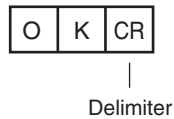

When the Command Is Not Processed Normally

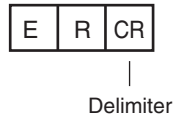

<Parameter Descriptions>

Inspection item number	Specifies the item number of the position compensation item or of the filter item.
External reference data number	Specifies the external reference data number. Section 9-2 External Reference Parameters in Vision Sensor FQ2-S/CH Series User's Manual (Cat. No. Z337)
Setting value	Specifies the set value. Section 9-2 External Reference Parameters in Vision Sensor FQ2-S/CH Series User's Manual (Cat. No. Z337)

SYSDATA or SD

Set System Data

Sets the value to the specified system data.

 System data numbers and details: p. 222

<Command Format>

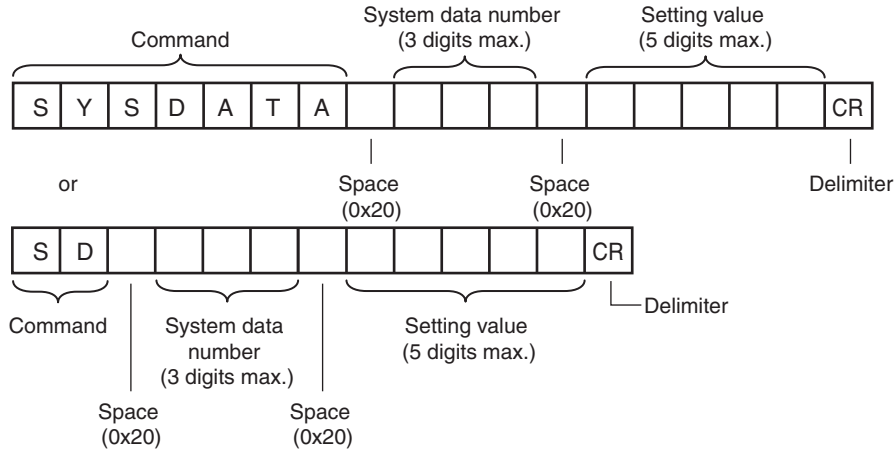

<Response Format>

When the Command Is Processed Normally

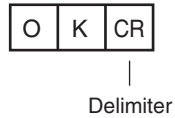

When the Command Is Not Processed Normally

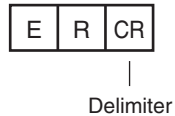

<Parameter Descriptions>

System data number*	Specifies the number that corresponds to the system data to be set.
Setting value	Specifies the setting value to be set to the system data.

Load Setting Data Commands

SCNLOAD

This command loads scene data that is stored on the SD card inserted in the Touch Finder. The source for scene data is the following fixed directory on the SD card.

\Sensor name\SCN

<Command format>

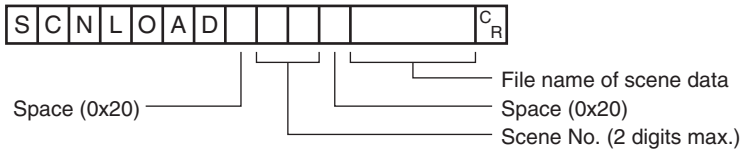

<Response format>

When Processing Is Performed Normally

`OK CR`

When Processing Is Not Performed Normally

`ER CR`

<Parameter Descriptions>

Scene No.	Specifies the scene No. to be read (0 to 31)
File name of scene data	Specifies the scene data file name you want to load. (64 characters max.) Only files that have an "SCN" extension can be read.

Important

Do not turn off power to the Vision Sensor until there is a response.

CLBLOAD

This command loads calibration data that is stored on the SD card inserted in the Touch Finder as the data for the specified calibration number.

The source for calibration data is the following fixed directory on the SD card.

\Sensor name\CLB

<Command Format>

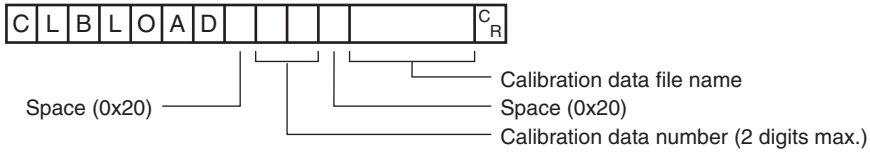

<Response Format>

When the Command Is Processed Normally

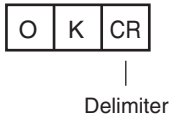

When the Command Is Not Processed Normally

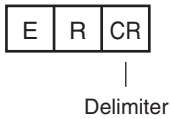

<Parameter Descriptions>

Calibration number	Specifies the calibration data number you want to load (0 to 31)
Calibration data file name	Specifies the calibration data file name you want to load. (64 characters max.) The file name extension (.clb) can be omitted.

Important

Do not turn off power to the Vision Sensor until there is a response.

CGRLOAD

This command loads all calibration data that is stored on the SD card inserted in the Touch Finder. The source for all calibration data is the following fixed directory on the SD card.

\\Sensor name\\CGP

<Command Format>

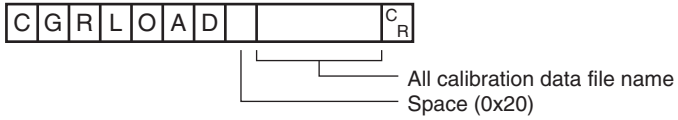

<Response Format>

When the Command Is Processed Normally

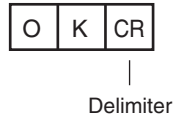

When the Command Is Not Processed Normally

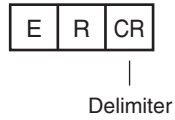

<Parameter Descriptions>

All calibration data file name	Specifies the all calibration data file name to be loaded. (64 characters max.) The file name extension (.cgp) can be omitted. Only files with the extension "CGP" can be loaded.
--------------------------------	---

Important

Do not turn off power to the Vision Sensor until there is a response.

DICLOAD

This command loads model dictionary data that is stored on the SD card inserted in the Touch Finder as the model dictionary with the specified number.

The source for model dictionary data is the following fixed directory on the SD card.

\Sensor name\DIC

<Command Format>

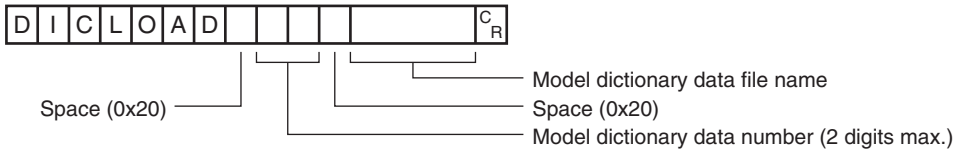

<Response Format>

When the Command Is Processed Normally

O	K	CR
---	---	----

Delimiter

When the Command Is Not Processed Normally

E	R	CR
---	---	----

Delimiter

<Parameter Descriptions>

Model dictionary data number	Specifies the model dictionary data number you want to load. (0 to 31)
Model dictionary data file name	Specifies the model dictionary data file name you want to load. (64 characters max.) The file name extension (.dic) can be omitted.

Important

Do not turn off power to the Vision Sensor until there is a response.

DGRLOAD

This command loads all model dictionary data that is stored on the SD card inserted in the Touch Finder. The source for all model dictionary data is the following fixed directory on the SD card.

\\Sensor name\DGP

<Command Format>

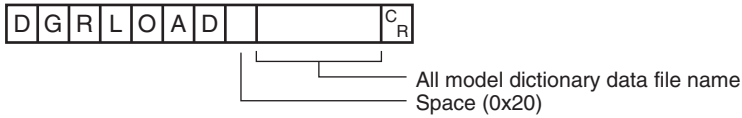

<Response Format>

When the Command Is Processed Normally

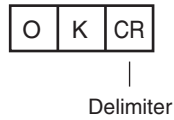

When the Command Is Not Processed Normally

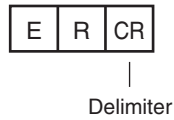

<Parameter Descriptions>

All model dictionary data file name	Specifies the all model dictionary data file name to be loaded. (64 characters max.) The file name extension (.dgp) can be omitted. Only files with the extension "DGP" can be loaded.
-------------------------------------	--

Important

Do not turn off power to the Vision Sensor until there is a response.

Save Configuration Data Commands

SCNSAVE

This command saves scene data to the SD card inserted in the Touch Finder as a file.

The destination for scene data is the following fixed directory on the SD card.

\Sensor name\SCN

<Command format>

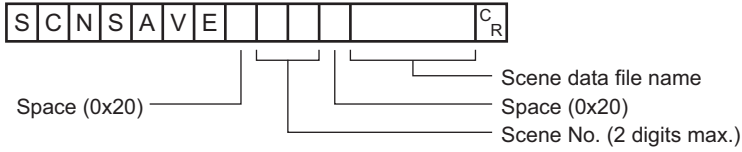

<Response format>

When Processing Is Performed Normally

OK^{C_R}

When Processing Is Not Performed Normally

ER^{C_R}

<Parameter Descriptions>

Scene No.	Specifies the scene No. to save (0 to 31).
Scene data file name	Specifies the file name when saving. The file name extension (.scn) can be omitted.

Important

- If the specified file name already exists, this existing file will be overwritten.
- Do not turn off power to the Vision Sensor until there is a response.

SGRSAVE

This command saves all scene data as a file to the SD card inserted in the Touch Finder. The destination for all scene data is the following fixed directory on the SD card.

\Sensor name\SGP

<Command format>

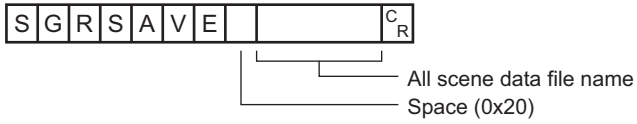

<Response format>

When Processing Is Performed Normally

OK_{C_R}

When Processing Is Not Performed Normally

ER_{C_R}

<Parameter Descriptions>

All scene data file name	Specifies the all scene data file name to be saved. (64 characters max.) The file name extension (.sgp) can be omitted.
--------------------------	--

Important

- If the specified file name already exists, this existing file will be overwritten.
- Do not turn off power to the Vision Sensor until there is a response.

SYSSAVE

Saves system data as a file to the SD card inserted in the Touch Finder.
The destination for system data is the following fixed directory on the SD card.
Sensor name\SYD

<Command format>

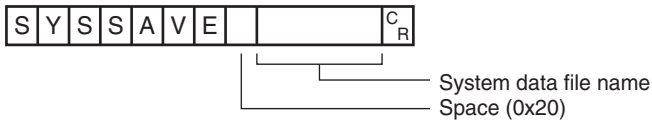

<Response format>

When Processing Is Performed Normally

OK^{CR}

When Processing Is Not Performed Normally

ER^{CR}

<Parameter Descriptions>

System data file name	Specifies the file name when saving system data. (64 characters max.) The file name extension (.syd) can be omitted.
-----------------------	---

Important

- If the specified file name already exists, this existing file will be overwritten.
- Do not turn off power to the Vision Sensor until there is a response.

IMAGESAVE

Saves image data saved in the Sensor's memory by the logging function to the SD card inserted in the Touch Finder as ifz data.

The destination for image data is the following fixed directory on the SD card.

\Sensor name\LOGIMAGE\Number*

* Number is a five digit number starting from 00000. The images are saved in increments of 100 images for each number, and when there are over 100 images, the directory with the next number is created.

<Command format>

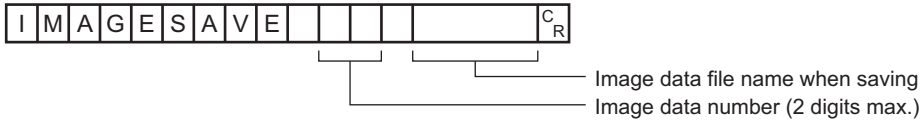

or

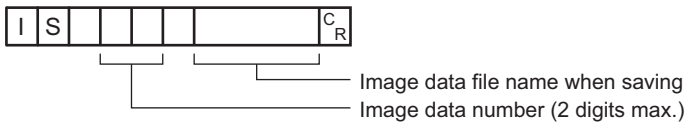

<Response format>

When Processing Is Performed Normally

OK_{C_R}

When Processing Is Not Performed Normally

ER_{C_R}

<Parameter Descriptions>

Image data number	Specifies the number of the image data to be saved. The maximum number of logged images is 20 (image data number: 0 to 19). The image data number of the latest image is 0.
Image data file name	Specifies the image data file name when saving. (64 characters max.) The file name extension (.ifz) can be omitted.

Important

- If the specified file name already exists, this existing file will be overwritten.
- Do not turn off power to the Vision Sensor until there is a response.

ALLIMAGESAVE or AIS

This command saves all image data saved in the Sensor's memory by the logging function to the SD card inserted in the Touch Finder as ifz data.

The destination for logging image data is the following fixed directory on the SD card.

\Sensor name\LOGIMAGE\Number*

* Number is a five digit number starting from 00000. The images are saved in increments of 100 images for each number, and when there are over 100 images, the directory with the next number is created.

<Command format>

A L L I M A G E S A V E ^{C_R}

or

A I S ^{C_R}

<Response format>

When Processing Is Performed Normally

OK ^{C_R}

When Processing Is Not Performed Normally

ER ^{C_R}

- Image data file names

Image data file names are automatically created as follows.

img_ScnNNN_YYYY_MM_DD-HH_mm_ss(S)_TTTT_XX.ifz

img	Prefix string. The string can be set as desired with the following setting.  (Setup Mode or Run Mode) – [TF settings] – [File format]
ScnNNN	Scn + measured scene number (0 to 31)
YYYY_MM_DD	Date that the image data was saved to the Touch Finder SD card* ¹
HH_mm_ss	Time that the image data was saved to the Touch Finder SD card* ¹
(S)	When there are image files measured at the same time, a sequential number is added in the order the images were created. (1 to 9)
TTTT	Number of measurements since the Sensor was started. Reset when the power supply is turned OFF. (0000 to 9999)
XX	Total judgment (OK/NG)

*¹ The date and time are not recorded in the image data. Therefore, this is not the date and time that the measurement was performed, this is the date and time the image data file was saved from the Sensor to the Touch Finder SD card by this command.

For example, when performing the 10th measurement with scene 1 after the Sensor's power supply has been turned on, and the execution time of this command is December 5, 2013, at 22:10:21
img_Scn001_2013_12_05-22_01_21(1)_0010_OK.ifz

BKDSAVE

This command saves all setting data (all scene data, system data, calibration group data) for the Sensor to the SD card inserted in the Touch Finder as a backup file.

The destination for backup data is the following fixed directory on the SD card.

\Sensor name\BKD

<Command format>

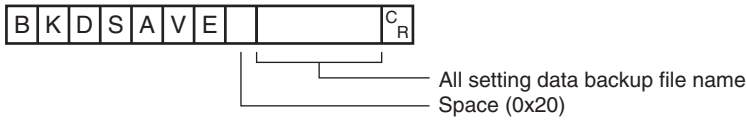

<Response format>

When Processing Is Performed Normally

`OK`_{C_R}

When Processing Is Not Performed Normally

`ER`_{C_R}

<Parameter Descriptions>

All setting data backup file name	This command specifies the all setting data backup file name. The file name extension (.bkd) can be omitted.
-----------------------------------	--

Important

- If the specified file name already exists, this existing file will be overwritten.
- Do not turn off power to the Vision Sensor until there is a response.

CLBSAVE

This command saves the calibration data with the specified calibration number as a file to the SD card inserted in the Touch Finder.

The destination for calibration data is the following fixed directory on the SD card.

\Sensor name\CLB

<Command Format>

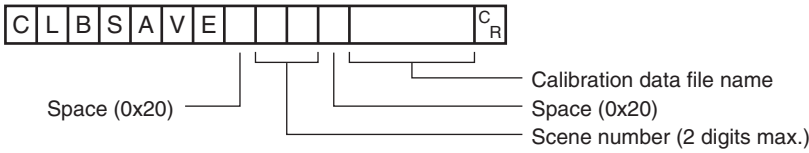

<Response Format>

When the Command Is Processed Normally

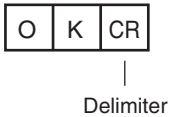

When the Command Is Not Processed Normally

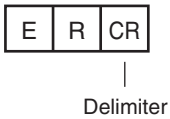

<Parameter Descriptions>

Scene number	Specifies the scene number (0 to 31) to be saved.
Calibration data file name	Specifies the file name when saving. The file name extension (.clb) can be omitted.

Important

- If the specified file name already exists, this existing file will be overwritten.
- Do not turn off power to the Vision Sensor until there is a response.

CGRSAVE

Saves all calibration data as a file to the SD card inserted in the Touch Finder.

The destination for all calibration data is the following fixed directory on the SD card.

\Sensor name\CGP

<Command Format>

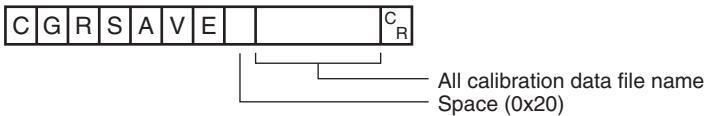

<Response Format>

When the Command Is Processed Normally

OK^{CR}

When the Command Is Not Processed Normally

ER^{CR}

<Parameter Descriptions>

All calibration data file name	Specifies the all calibration data file name to be saved. (64 characters max.) The file name extension (.cgp) can be omitted.
--------------------------------	--

Important

- If the specified file name already exists, this existing file will be overwritten.
- Do not turn off power to the Vision Sensor until there is a response.

DICSAVE

Saves model dictionary data as a file to the SD card inserted in the Touch Finder.

The destination for model dictionary data is the following fixed directory on the SD card.

\Sensor name\DIC

<Command Format>

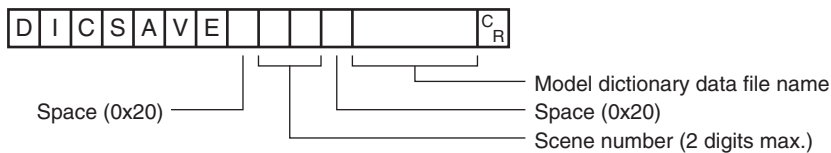

<Response Format>

When the Command Is Processed Normally

OK CR

Delimiter

When the Command Is Not Processed Normally

ER CR

Delimiter

<Parameter Descriptions>

Scene number	Specifies the scene number (0 to 31) to be saved.
Model dictionary data file name	Specifies the file name when saving. The file name extension (.dic) can be omitted.

Important

- If the specified file name already exists, this existing file will be overwritten.
- Do not turn off power to the Vision Sensor until there is a response.

LASTIMAGESAVE or LIS

Saves the latest input image to the SD card inserted in the Touch Finder as ifz data.

The destination for image data is the following fixed directory on the SD card.

\\Sensor name\CAPTURE\Number*

* Number is a five digit number starting from 00000. The images are saved in increments of 100 images for each number, and when there are over 100 images, the directory with the next number is created.

<Command Format>

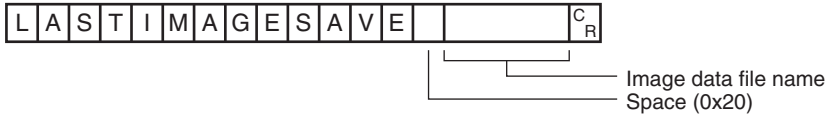

or

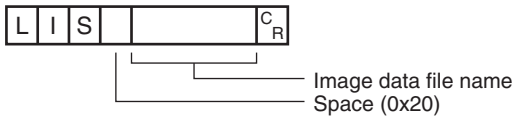

<Response Format>

When the Command Is Processed Normally

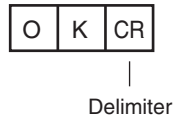

When the Command Is Not Processed Normally

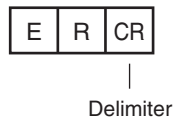

<Parameter Descriptions>

Image data file name	Specifies the image data file name to save. (64 characters max.) The file name extension (.ifz) can be omitted.
----------------------	--

Important

- If the specified file name already exists, this existing file will be overwritten.
- Do not turn off power to the Vision Sensor until there is a response.

LOGDATASAVE or LDS

Saves measurement data saved in the Sensor's memory by the logging function to the SD card inserted in the Touch Finder as csv data.

The destination for measurement data is the following fixed directory on the SD card.

\Sensor name\LOGDATA

The file name is automatically created as follows.

YYYY_MM_DD-HH_mm_ss.csv

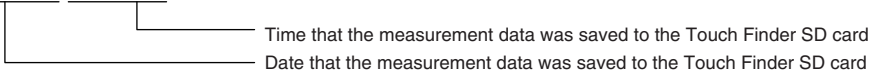

The date and time that make up the measurement data file name are not the date and time that the measurement was performed, they are the date and time the measurement data file was saved from the Sensor to the Touch Finder SD card by this command.

<Command Format>

L	O	G	D	A	T	A	S	A	V	E	C	R
---	---	---	---	---	---	---	---	---	---	---	---	---

or

L	D	S	C	R
---	---	---	---	---

<Response Format>

When the Command Is Processed Normally

O	K	CR
---	---	----

Delimiter

When the Command Is Not Processed Normally

E	R	CR
---	---	----

Delimiter

Important

Do not turn off power to the Vision Sensor until there is a response.

TOTALDATASAVE or TDS

Saves statistical data saved in the Sensor's memory by the logging function to the SD card inserted in the Touch Finder as csv data.

The destination for statistical data is the following fixed directory on the SD card.

\Sensor name\LOGDATA

The file name is automatically created as follows.

YYYY_MM_DD-HH_mm_record.csv

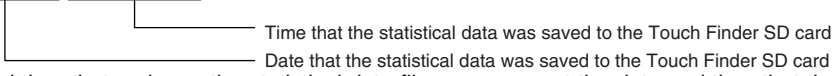

The date and time that make up the statistical data file name are not the date and time that the measurement was performed, they are the date and time the statistical data file was saved from the Sensor to the Touch Finder SD card by this command.

<Command Format>

T	O	T	A	L	D	A	T	A	S	A	V	E	C	R
---	---	---	---	---	---	---	---	---	---	---	---	---	---	---

or

T	D	S	C	R
---	---	---	---	---

<Response Format>

When the Command Is Processed Normally

O	K	C	R
---	---	---	---

Delimiter

When the Command Is Not Processed Normally

E	R	C	R
---	---	---	---

Delimiter

Important

Do not turn off power to the Vision Sensor until there is a response.

Load Commands for Binary Data Files

PRESCNLOADB (Check) / SCNLOADB (Execute)

Loading scene data (binary data)

The Sensor loads scene data in binary format.

To execute this command, two types of commands are used, a confirmation command and an execution command.

For how to execute the command using the confirmation command and the execution command, refer to [□ Binary Data File Load and Save Commands: p. 183.](#)

<Confirmation command format>

Before loading scene data in binary data format, the Sensor checks whether or not it can receive binary data.

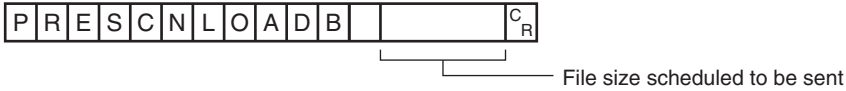

<Confirmation command response format>

When the Command Is Processed Normally



When the Command Is Not Processed Normally



<Execution command format>

Loads scene data in binary data format.

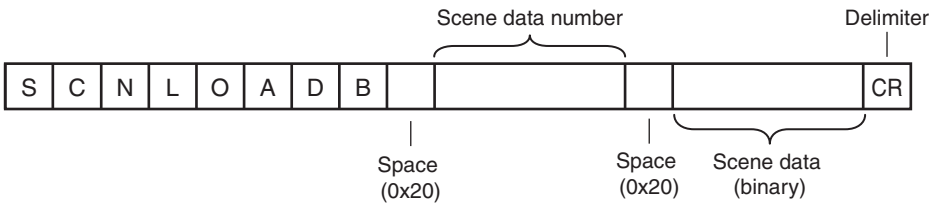

<Execution command response format>

When the Command Is Processed Normally

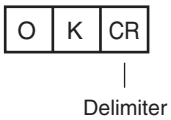

When the Command Is Not Processed Normally

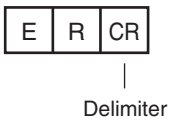

<Parameter Descriptions>

File size scheduled to be sent	Number of bytes of scene data scheduled to send (integer type)
Scene data number	Specifies the scene number you want to load. (Integer type) Specify 0 to 31.
Scene data (binary)	Scene data to be loaded (binary data)

PRESGRLOADB (Check) / SGRLOADB (Execute)

Loading all scene data (binary data)

The Sensor loads all scene data in binary format.

To execute this command, two types of commands are used, a confirmation command and an execution command.

For how to execute the command using the confirmation command and the execution command, refer to [□□ Binary Data File Load and Save Commands: p. 183.](#)

<Confirmation command format>

Before loading all scene data in binary data format, the Sensor checks whether or not it can receive binary data.

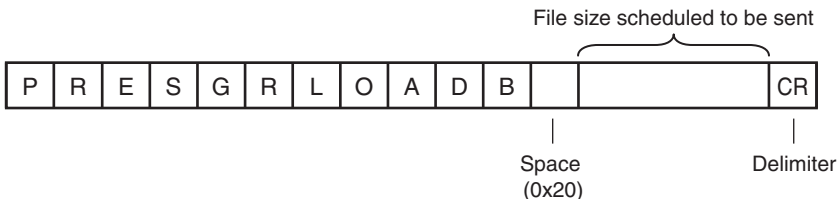

<Confirmation command response format>

When the Command Is Processed Normally

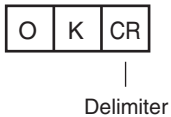

When the Command Is Not Processed Normally

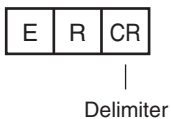

<Execution command format>

Loads all scene data in binary data format.

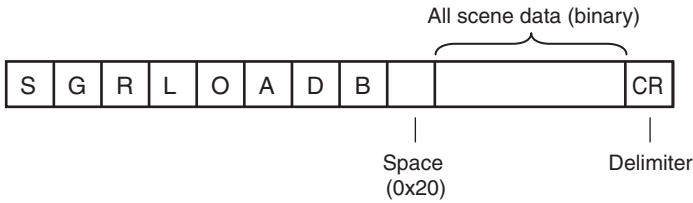

<Execution command response format>

When the Command Is Processed Normally

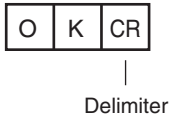

When the Command Is Not Processed Normally

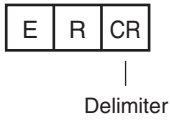

<Parameter Descriptions>

File size scheduled to be sent	Number of bytes of all scene data scheduled to send (integer type)
All scene data (binary)	All scene data to be loaded (binary data)

PRESYSLOADB (Check) / SYSLOADB (Execute)

Loading system data (binary data)

The Sensor loads system data in binary format.

To execute this command, two types of commands are used, a confirmation command and an execution command.

For how to execute the command using the confirmation command and the execution command, refer to [□ Binary Data File Load and Save Commands: p. 183.](#)

<Confirmation command format>

Before loading system data in binary data format, the Sensor checks whether or not it can receive binary data.

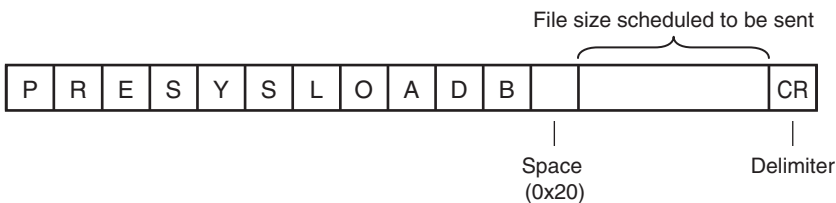

<Confirmation command response format>

When the Command Is Processed Normally

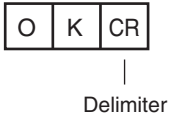

When the Command Is Not Processed Normally

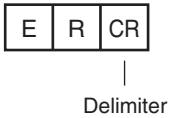

<Execution command format>

Loads system data in binary data format.

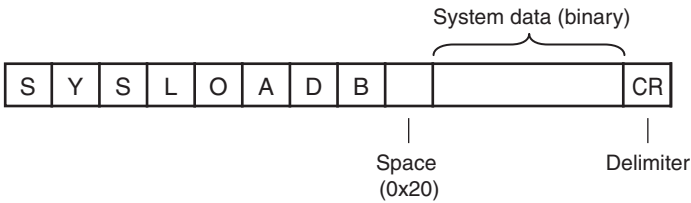

<Execution command response format>

When the Command Is Processed Normally

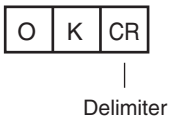

When the Command Is Not Processed Normally

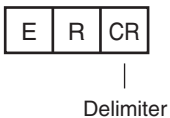

<Parameter Descriptions>

File size scheduled to be sent	Number of bytes of system data scheduled to be sent (integer type)
System data (binary)	System data to be loaded (binary data)

PREBKDLADB (Check) / BKDLADB (Execute)

Loading all setting data for the Sensor (binary data)

The Sensor loads all setting data (all scene data, system data, calibration group data) for the Sensor saved as a backup file.

To execute this command, two types of commands are used, a confirmation command and an execution command.

For how to execute the command using the confirmation command and the execution command, refer to Binary Data File Load and Save Commands: p. 183.

<Confirmation command format>

Before loading all setting data for the Sensor in binary data format, the Sensor checks whether or not it can receive binary data.

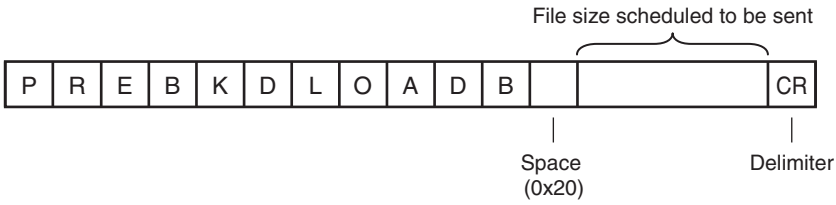

<Confirmation command response format>

When the Command Is Processed Normally

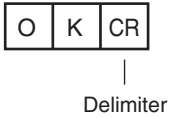

When the Command Is Not Processed Normally

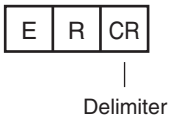

<Execution command format>

Loads all setting data for the Sensor in binary data format.

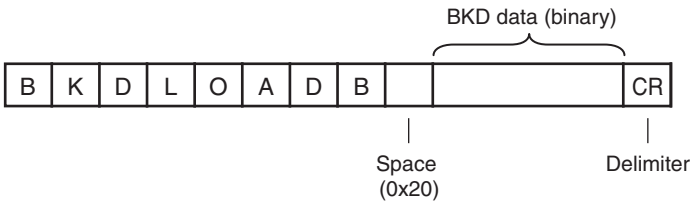

<Execution command response format>

When the Command Is Processed Normally

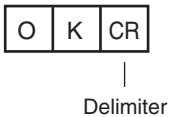

When the Command Is Not Processed Normally

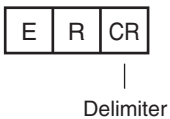

<Parameter Descriptions>

File size scheduled to be sent	Number of bytes of all setting data for the Sensor scheduled to be sent (integer type)
BKD data (binary)	All setting data for the Sensor to be loaded (binary data)

PRECLBLOADB (Check) / CLBLOADB (Execute)

Loading calibration data (binary data)

The Sensor loads calibration data in binary format as the specified calibration number.

To execute this command, two types of commands are used, a confirmation command and an execution command.

For how to execute the command using the confirmation command and the execution command, refer to [□ Binary Data File Load and Save Commands: p. 183](#).

<Confirmation command format>

Before loading calibration data in binary data format, the Sensor checks whether or not it can receive binary data.

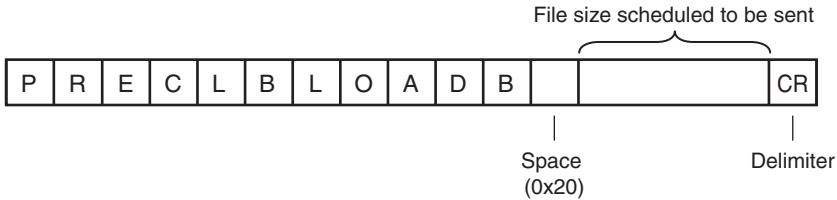

<Confirmation command response format>

When the Command Is Processed Normally

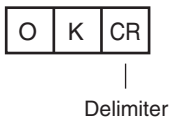

When the Command Is Not Processed Normally

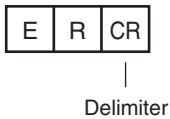

<Execution command format>

Loads calibration data in binary data format.

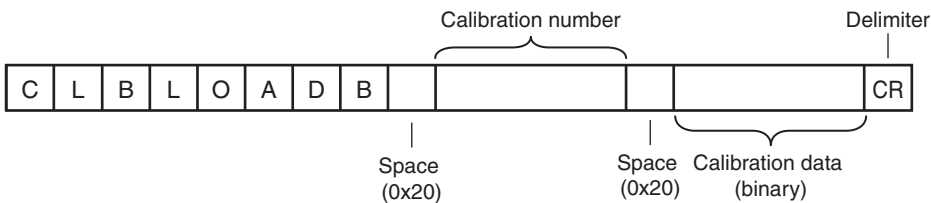

<Execution command response format>

When the Command Is Processed Normally

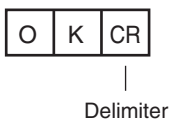

When the Command Is Not Processed Normally

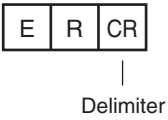

<Parameter Descriptions>

File size scheduled to be sent	Number of bytes of calibration data scheduled to be sent (integer type)
Calibration data number	Specifies the calibration number you want to load. (Integer type) Specify 0 to 31.
Calibration data (binary)	Calibration data to be loaded (binary data)

PRECGRLOADB (Check) / CGRLOADB (Execute)

Loading all calibration data (binary data)

The Sensor loads all calibration data in binary data format.

To execute this command, two types of commands are used, a confirmation command and an execution command.

For how to execute the command using the confirmation command and the execution command, refer to Binary Data File Load and Save Commands: p. 183.

<Confirmation command format>

Before loading all calibration data in binary data format, the Sensor checks whether or not it can receive binary data.

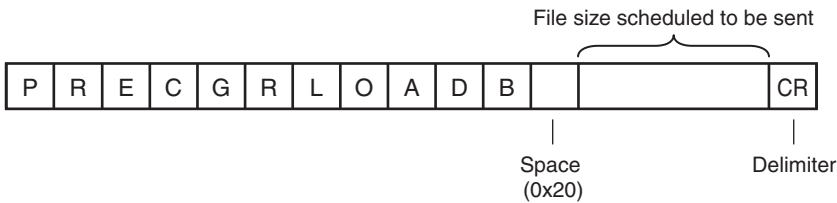

<Confirmation command response format>

When the Command Is Processed Normally

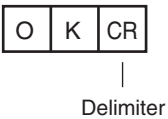

When the Command Is Not Processed Normally

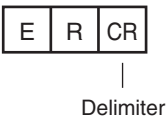

<Execution command format>

Loads all calibration data in binary data format.

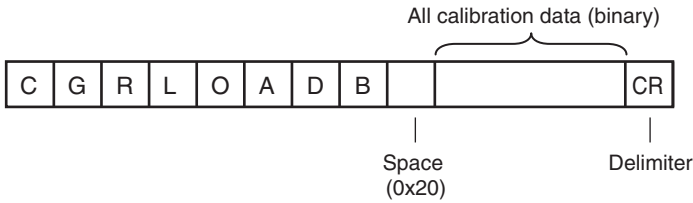

<Execution command response format>

When the Command Is Processed Normally

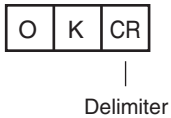

When the Command Is Not Processed Normally

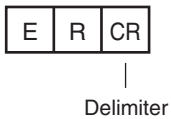

<Parameter Descriptions>

File size scheduled to be sent	Number of bytes of all calibration data scheduled to send (integer type)
All calibration data (binary)	All calibration data to be loaded (binary data)

PREDICLOADB (Check) / DICLOADB (Execute)

Loading model dictionary data (binary data)

The Sensor loads model dictionary data in binary data format as the model dictionary with the specified number.

To execute this command, two types of commands are used, a confirmation command and an execution command.

For how to execute the command using the confirmation command and the execution command, refer to [□□ Binary Data File Load and Save Commands: p. 183](#).

<Confirmation command format>

Before loading model dictionary data in binary data format, the Sensor checks whether or not it can receive binary data.

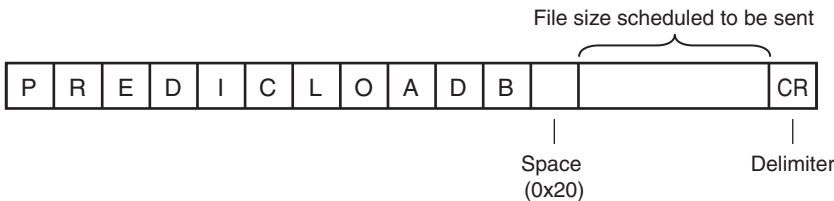

<Confirmation command response format>

When the Command Is Processed Normally

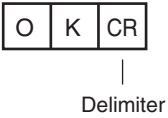

When the Command Is Not Processed Normally

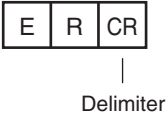

<Execution command format>

Loads model dictionary data in binary data format.

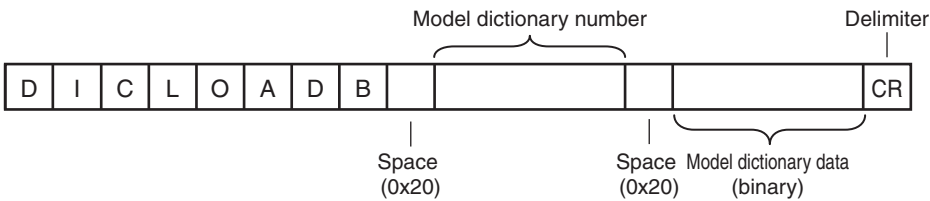

<Execution command response format>

When the Command Is Processed Normally

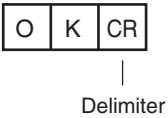

When the Command Is Not Processed Normally

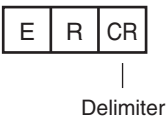

<Parameter Descriptions>

File size scheduled to be sent	Number of bytes of model dictionary data scheduled to send (integer type)
Model dictionary data number	Specifies the model dictionary number you want to load. (Integer type) Specify 0 to 31.
Model dictionary data (binary)	Model dictionary data to be loaded (binary data)

PREDGRLOADB (Check) / DGRLOADB (Execute)

Loading all model dictionary data (binary data)

The Sensor loads all model dictionary data in binary data format.

To execute this command, two types of commands are used, a confirmation command and an execution command.

For how to execute the command using the confirmation command and the execution command, refer to Binary Data File Load and Save Commands: p. 183.

<Confirmation command format>

Before loading all model dictionary data in binary data format, the Sensor checks whether or not it can receive binary data.

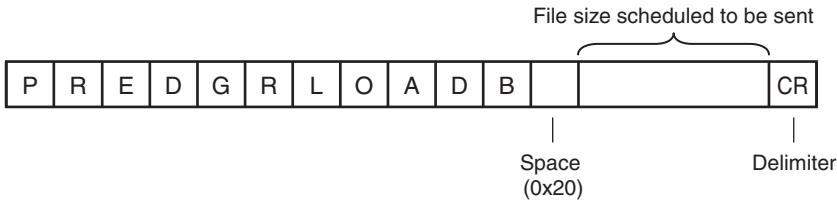

<Confirmation command response format>

When the Command Is Processed Normally

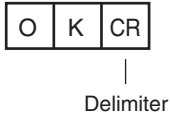

When the Command Is Not Processed Normally

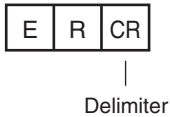

<Execution command format>

Loads all model dictionary data in binary data format.

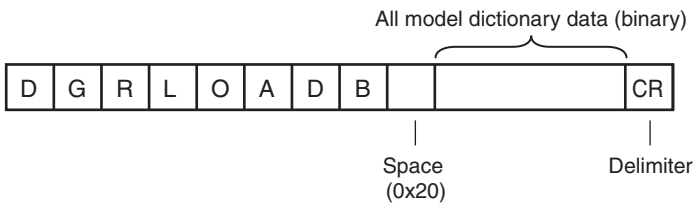

<Execution command response format>

When the Command Is Processed Normally

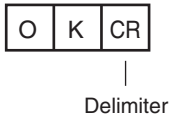

When the Command Is Not Processed Normally

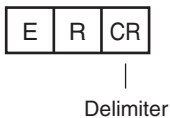

<Parameter Descriptions>

File size scheduled to be sent	Number of bytes of all model dictionary data scheduled to send (integer type)
All model dictionary data (binary)	All model dictionary data to be loaded (binary data)

Save Commands for Binary Data Files

PRESCNSAVEB (Check) / SCNSAVEB (Execute)

Outputting scene data (binary data)

This command outputs scene data for the Sensor in binary data format.

To execute this command, two types of commands are used, a confirmation command and an execution command.

For how to execute the command using the confirmation command and the execution command, refer to  Binary Data File Load and Save Commands: p. 183.

<Confirmation command format>

Before scene data in binary data format is output, a check is performed to determine if the data can be received by the external device that will receive the data.

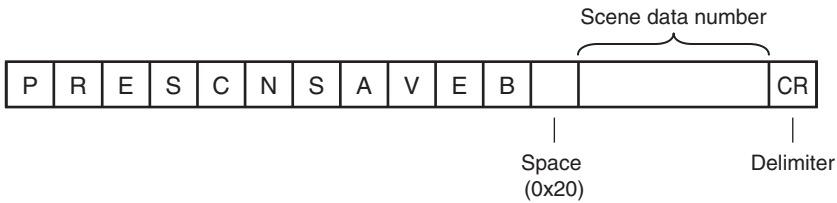

<Confirmation command response format>

When the Command Is Processed Normally

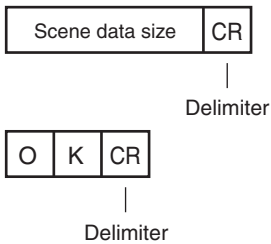

When the Command Is Not Processed Normally

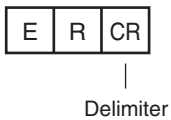

<Execution command format>

This command outputs the scene data in binary data format.

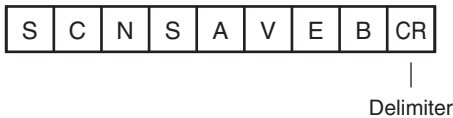

<Execution command response format>

When the Command Is Processed Normally

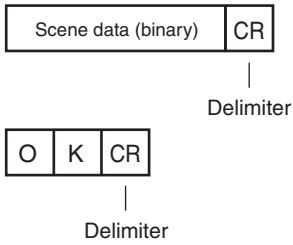

When the Command Is Not Processed Normally

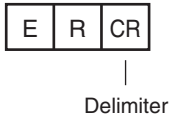

<Parameter Descriptions>

Scene data number	Specifies the scene number (integer type) you want to output. Specify 0 to 31.
Scene data size	Number of bytes of scene data to output (integer type)
Scene data (binary)	Scene data to output (binary data)

PRESGRSAVEB (Check) / SGRSAVEB (Execute)

Outputting all scene data (binary data)

This command outputs all scene data for the Sensor in binary data format.

To execute this command, two types of commands are used, a confirmation command and an execution command.

For how to execute the command using the confirmation command and the execution command, refer to [□□ Binary Data File Load and Save Commands: p. 183](#).

<Confirmation command format>

Before all scene data in binary data format is output, a check is performed to determine if the data can be received by the external device that will receive the data.

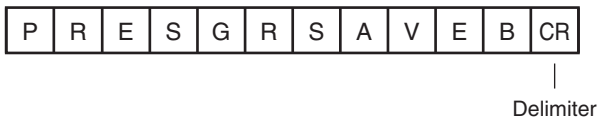

<Confirmation command response format>

When the Command Is Processed Normally

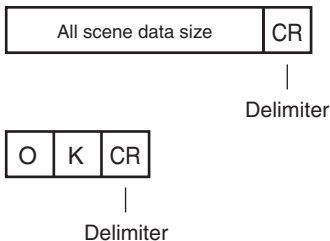

When the Command Is Not Processed Normally

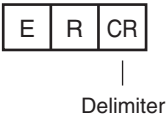

<Execution command format>

This command outputs all scene data in binary data format.

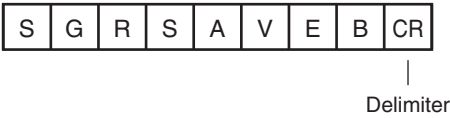

<Execution command response format>

When the Command Is Processed Normally

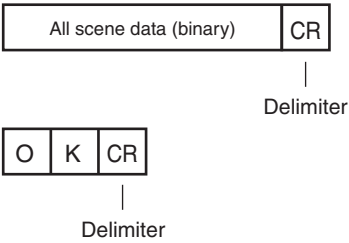

When the Command Is Not Processed Normally

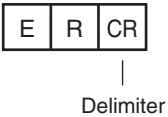

<Parameter Descriptions>

All scene data size	Number of bytes of all scene data to output (integer type)
All scene data (binary)	All scene data to output (binary data)

PRESYSABEB (Check) / SYSSABEB (Execute)

Outputting system data (binary data)

This command outputs system data for the Sensor in binary data format.

To execute this command, two types of commands are used, a confirmation command and an execution command.

For how to execute the command using the confirmation command and the execution command, refer to Binary Data File Load and Save Commands: p. 183.

<Confirmation command format>

Before system data in binary data format is output, a check is performed to determine if the data can be received by the external device that will receive the data.

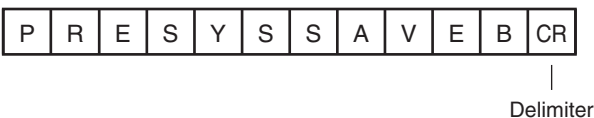

<Confirmation command response format>

When the Command Is Processed Normally

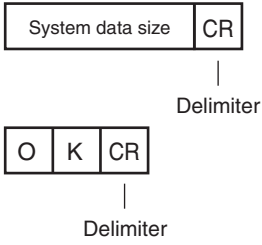

When the Command Is Not Processed Normally

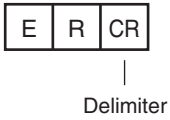

<Execution command format>

This command outputs system data in binary data format.

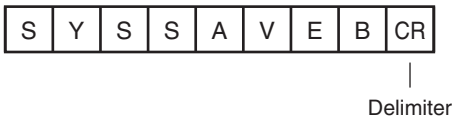

<Execution command response format>

When the Command Is Processed Normally

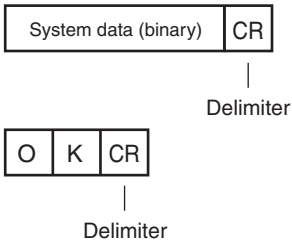

When the Command Is Not Processed Normally

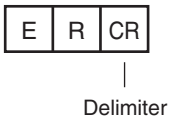

<Parameter Descriptions>

System data size	Number of bytes of system data to output (integer type)
System data (binary)	System data to output (binary data)

PREBKSAVEB (Check) / BKSAVEB (Execute)Outputting system data and all scene data (binary data)

This command outputs all setting data (all scene data, system data, calibration group data) for the Sensor as a backup file in binary data format.

To execute this command, two types of commands are used, a confirmation command and an execution command.

For how to execute the command using the confirmation command and the execution command, refer to  Binary Data File Load and Save Commands: p. 183.

<Confirmation command format>

Before all setting data being used by the current Sensor is output in binary data format, a check is performed to determine if the data can be received by the external device that will receive the data.

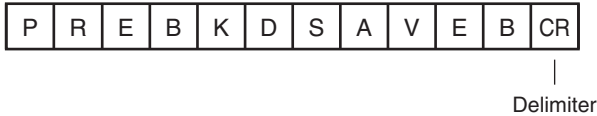

<Confirmation command response format>

When the Command Is Processed Normally

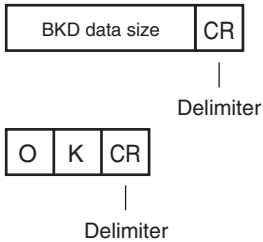

When the Command Is Not Processed Normally

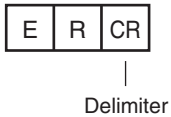

<Execution command format>

This command outputs all setting data being used by the current Sensor in binary data format.

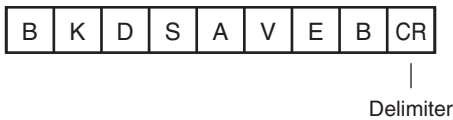

<Execution command response format>

When the Command Is Processed Normally

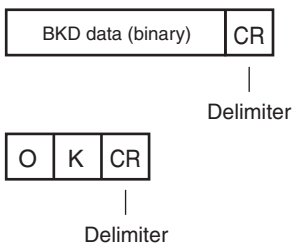

When the Command Is Not Processed Normally

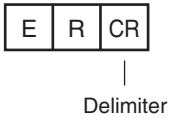

<Parameter Descriptions>

BKD data size	Number of bytes of all setting data to output (integer type)
BKD data (binary)	All setting data to output (binary data)

PREIMAGESAVEB (Check) / IMAGESAVEB (Execute)

Outputting image (binary data)

This command outputs images stored in the Sensor memory in binary format.

To execute this command, two types of commands are used, a confirmation command and an execution command.

For how to execute the command using the confirmation command and the execution command, refer to Binary Data File Load and Save Commands: p. 183.

<Confirmation command format>

Before images saved to the Sensor's memory are output in binary data format, a check is performed to determine if the data can be received by the external device that will receive the data.

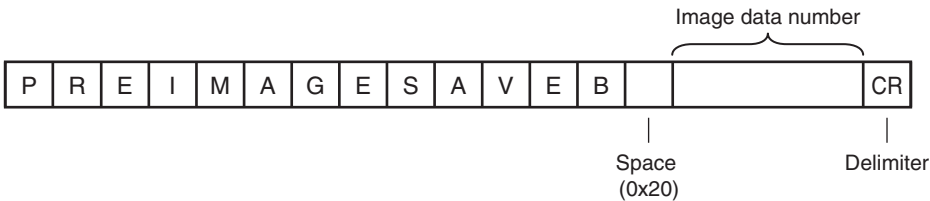

<Confirmation command response format>

When the Command Is Processed Normally

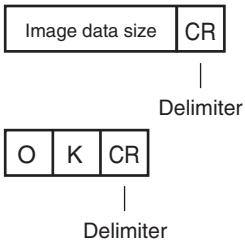

When the Command Is Not Processed Normally

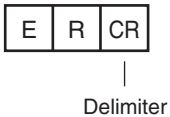

<Execution command format>

Outputs image data stored in the Sensor memory in binary format.



<Execution command response format>

When the Command Is Processed Normally

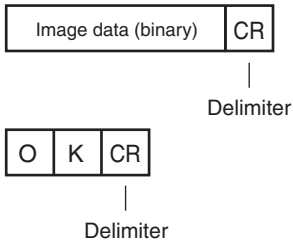

When the Command Is Not Processed Normally

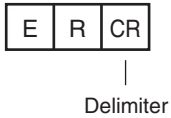

<Parameter Descriptions>

Image data number	Specifies the image data number (integer type) you want to output. Specify 0 to 19.
Image data size	Number of bytes of image data to output (integer type)
Image data (binary)	Image data to output (binary data)

PREALLIMAGESAVEB (Check) / ALLIMAGESAVEB (Execute)Outputting all image (binary data)

This command outputs all images stored in the Sensor memory in binary format.

To execute this command, two types of commands are used, a confirmation command and an execution command.

For how to execute the command using the confirmation command and the execution command, refer to  Binary Data File Load and Save Commands: p. 183.

<Confirmation command format>

Before all images saved to the Sensor's memory are output in binary data format, a check is performed to determine if the data can be received by the external device that will receive the data.



<Confirmation command response format>

When the Command Is Processed Normally

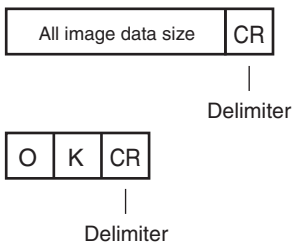

When the Command Is Not Processed Normally

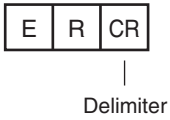

<Execution command format>

Outputs all image data stored in the Sensor memory in binary format.

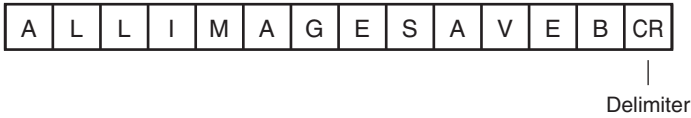

<Execution command response format>

When the Command Is Processed Normally

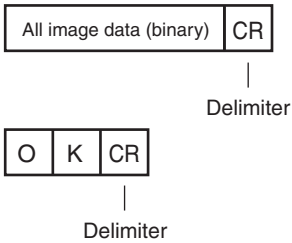

When the Command Is Not Processed Normally

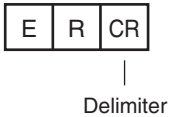

<Parameter Descriptions>

All image data size	Number of bytes of image data to output (integer type)
All image data (binary)	Image data to output (binary data)

PRECLBSAVEB (Check) / CLBSAVEB (Execute)

Outputting calibration data (binary data)

This command outputs data with the specified calibration number in binary data format.

To execute this command, two types of commands are used, a confirmation command and an execution command.

For how to execute the command using the confirmation command and the execution command, refer to Binary Data File Load and Save Commands: p. 183.

<Confirmation command format>

Before calibration data in binary data format is output, a check is performed to determine if the data can be received by the external device that will receive the data.

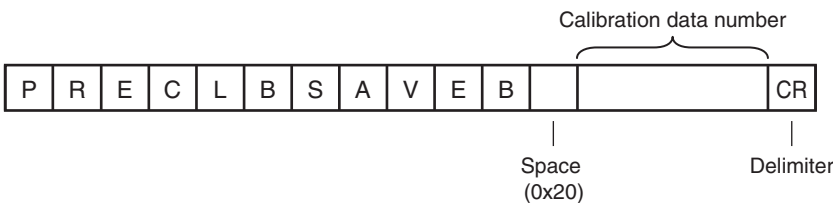

<Confirmation command response format>

When the Command Is Processed Normally

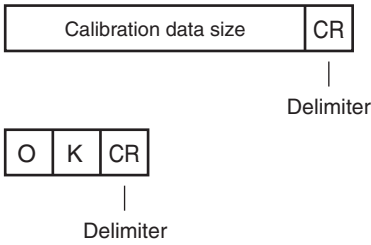

When the Command Is Not Processed Normally

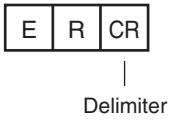

<Execution command format>

This command outputs the calibration data in binary data format.

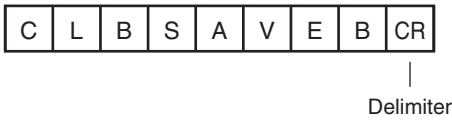

<Execution command response format>

When the Command Is Processed Normally

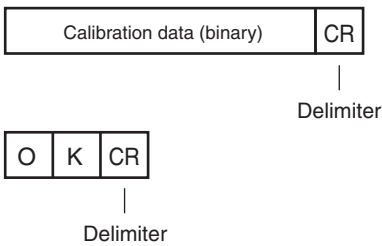

When the Command Is Not Processed Normally

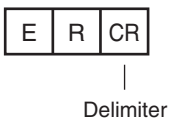

<Parameter Descriptions>

Calibration data number	Specifies the calibration number (integer type) you want to output. Specify 0 to 31.
Calibration data size	Number of bytes of calibration data to output (integer type)
Calibration data (binary)	Calibration data to output (binary data)

PREGRSAVEB (Check) / CGRSABEB (Execute)

Outputting all calibration data (binary data)

This command outputs all calibration data in binary data format.

To execute this command, two types of commands are used, a confirmation command and an execution command.

For how to execute the command using the confirmation command and the execution command, refer to [□ Binary Data File Load and Save Commands: p. 183](#).

<Confirmation command format>

Before all calibration data in binary data format is output, a check is performed to determine if the data can be received by the external device that will receive the data.



<Confirmation command response format>

When the Command Is Processed Normally

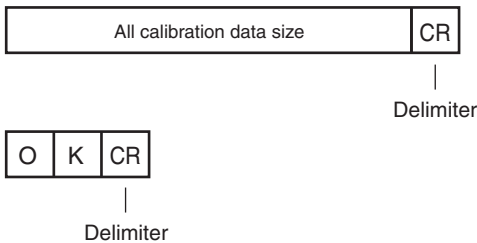

When the Command Is Not Processed Normally

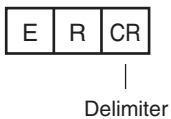

<Execution command format>

This command outputs the all calibration data in binary data format.

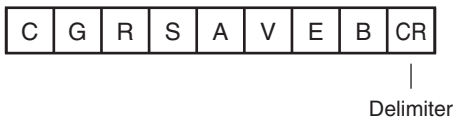

<Execution command response format>

When the Command Is Processed Normally

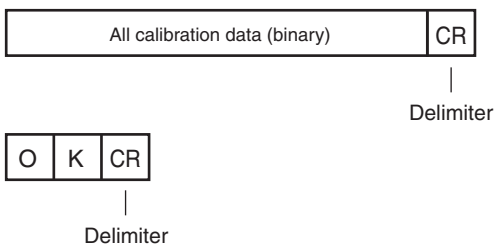

When the Command Is Not Processed Normally

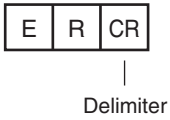

<Parameter Descriptions>

All calibration data size	Number of bytes of all calibration data to output (integer type)
All calibration data (binary)	All calibration data to output (binary data)

PREDICSAVEB (Check) / DICSAVEB (Execute)

Outputting model dictionary data (binary data)

This command outputs model dictionary data with the specified number in binary data format.

To execute this command, two types of commands are used, a confirmation command and an execution command.

For how to execute the command using the confirmation command and the execution command, refer to [□□ Binary Data File Load and Save Commands: p. 183](#).

<Confirmation command format>

Before model dictionary data is output in binary data format, a check is performed to determine if the data can be received by the external device that will receive the data.

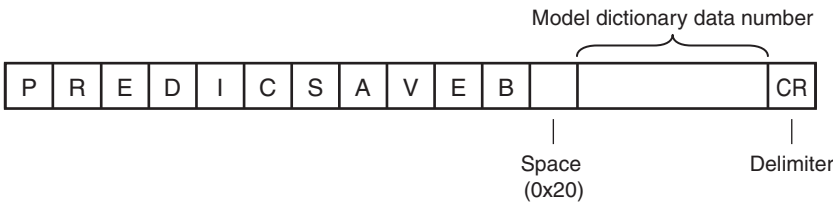

<Confirmation command response format>

When the Command Is Processed Normally

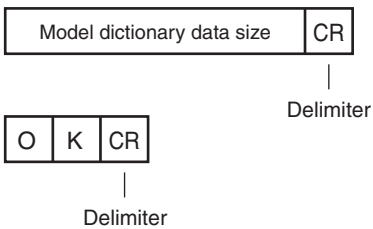

When the Command Is Not Processed Normally

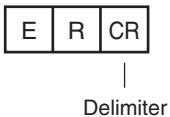

<Execution command format>

This command outputs model dictionary data in binary data format.

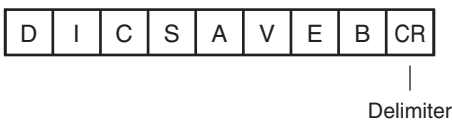

<Execution command response format>

When the Command Is Processed Normally

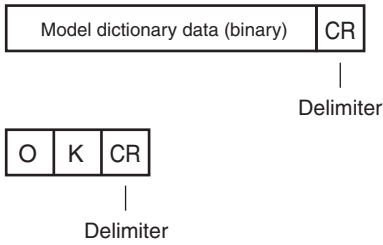

When the Command Is Not Processed Normally

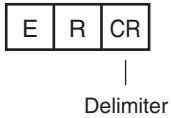

<Parameter Descriptions>

Model dictionary data number	Specifies the model dictionary data number (integer type) you want to output. Specify 0 to 31.
Model dictionary data size	Number of bytes of model dictionary data to output (integer type)
Model dictionary data (binary)	Model dictionary data to output (binary data)

PREDGRSAVEB (Check) / DGRSAVEB (Execute)

Outputting all model dictionary data (binary data)

This command outputs all model dictionary data in binary data format.

To execute this command, two types of commands are used, a confirmation command and an execution command.

For how to execute the command using the confirmation command and the execution command, refer to Binary Data File Load and Save Commands: p. 183.

<Confirmation command format>

Before all model dictionary data is output in binary data format, a check is performed to determine if the data can be received by the external device that will receive the data.

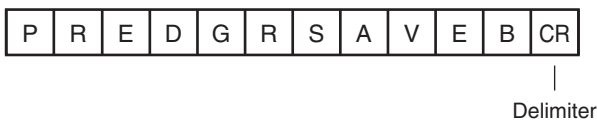

<Confirmation command response format>

When the Command Is Processed Normally

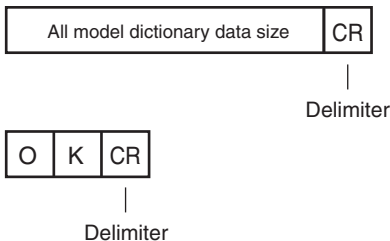

When the Command Is Not Processed Normally

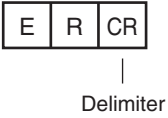

<Execution command format>

This command outputs all model dictionary data in binary data format.

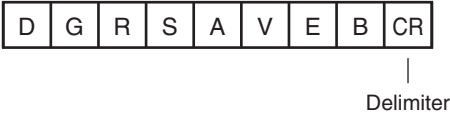

<Execution command response format>

When the Command Is Processed Normally

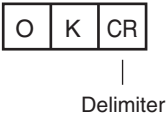
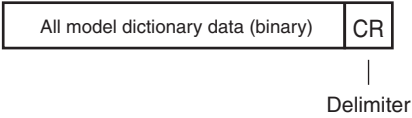

When the Command Is Not Processed Normally

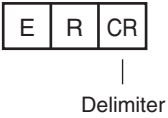

<Parameter Descriptions>

All model dictionary data size	Number of bytes of all model dictionary data to output (integer type)
All model dictionary data (binary)	All model dictionary data to output (binary data)

FINS Command Details

● Executing Measurements: 280F 00101010

This command executes one measurement.

If Ethernet output is not set, only the measurement is performed.

If Ethernet output is set, the measurement is performed and the result is returned as response data.

Command Format

MRC (1 byte)	SRC (1 byte)	Vision Sensor command code (4 bytes)
28	0F	00101010

Response Format

MRC (1 byte)	SRC (1 byte)	MRES (1 byte)	SRES (1 byte)	Vision Sensor command code (4 bytes)	Measurement result (1,024 bytes)
28	0F	End code		00101010	Measurement result

End Codes

End code (hex)	Meaning
0000	Command execution ended normally.
FFFF	Command execution ended in an error.

Parameter Descriptions

Measurement result	<ul style="list-style-type: none"> Returns the measurement result as the response when data output is set. The measurement result is not output when data output is not set. <ul style="list-style-type: none"> <input type="checkbox"/> Setting the Data to Output Automatically after Measurements: p. 169 Each data item requires 4 bytes. Up to 1,024 bytes of data can be received.
--------------------	--

● Clearing Measurement Values: 280F 00102010

This command clears the measurement values.

Command Format

MRC (1 byte)	SRC (1 byte)	Vision Sensor command code (4 bytes)
28	0F	00102010

Response Format

MRC (1 byte)	SRC (1 byte)	MRES (1 byte)	SRES (1 byte)	Vision Sensor command code (4 bytes)
28	0F	End code		00102010

End Codes

End code (hex)	Meaning
0000	Command execution ended normally.
FFFF	Command execution ended in an error.

● Clear Errors: 280F 00102040

This command clears the error output status (error output and error indicator).

Format

MRC (1 byte)	SRC (1 byte)	Vision Sensor command code (4 bytes)
28	0F	00102040

Response Format

MRC (1 byte)	SRC (1 byte)	MRES (1 byte)	SRES (1 byte)	Vision Sensor command code (4 bytes)
28	0F	End code		00102040

End Codes

End code (hex)	Meaning
0000	Command execution ended normally.
FFFF	Command execution ended in an error.

● **Clear Statistical Data: 280F 00102060**

This command clears the statistical data (such as the number of measurements, the number of NG overall judgments, the NG rate, and other information since the power supply was turned ON) produced by the logging function held by the Sensor.

Command Format

MRC (1 byte)	SRC (1 byte)	Vision Sensor command code (4 bytes)
28	0F	00102060

Response Format

MRC (1 byte)	SRC (1 byte)	MRES (1 byte)	SRES (1 byte)	Vision Sensor command code (4 bytes)
28	0F	End code		00102060

End Codes

End code (hex)	Description
0000	Command execution ended normally.
FFFF	Command execution ended in an error.

● **Save Data in the Sensor: 280F 00103010**

This command saves the current setting data (system data, scene groups, and calibration data) in the Sensor.

Format

MRC (1 byte)	SRC (1 byte)	Vision Sensor command code (4 bytes)
28	0F	00103010

Response Format

MRC (1 byte)	SRC (1 byte)	MRES (1 byte)	SRES (1 byte)	Vision Sensor command code (4 bytes)
28	0F	End code		00103010

End Codes

End code (hex)	Meaning
0000	Command execution ended normally.
FFFF	Command execution ended in an error.

● Re-register Models: 280F 00104010

This command re-registers the models for registered Search and Color Data inspection items.

Format

MRC (1 byte)	SRC (1 byte)	Vision Sensor command code (4 bytes)
28	0F	00104010

Response Format

MRC (1 byte)	SRC (1 byte)	MRES (1 byte)	SRES (1 byte)	Vision Sensor command code (4 bytes)
28	0F	End code		00104010

End Codes

End code (hex)	Meaning
0000	Command execution ended normally.
FFFF	Command execution ended in an error.

● **External Teach: 280F 00104020**

This command performs teaching for all applicable items.

Format

MRC (1 byte)	SRC (1 byte)	Vision Sensor command code (4 bytes)
28	0F	00104020

Response Format

MRC (1 byte)	SRC (1 byte)	MRES (1 byte)	SRES (1 byte)	Vision Sensor command code (4 bytes)
28	0F	End code		00104020

End Codes

End code (hex)	Meaning
0000	Command execution ended normally.
FFFF	Command execution ended in an error.

● Perform Teaching (Filter/Position Compensation Item): 280F 00104021

This command updates reference data for the specified image adjustment processing item (filter item/position compensation item).

For image adjustment processing items that have models, the model and reference data are updated.

Command Format

MRC (1 byte)	SRC (1 byte)	Vision Sensor command code (4 bytes)	Filter item/position compensation item number (4 bytes)
28	0F	00104021	Filter item/position compensation item number 0 to 7 (1 digit max.)

Response Format

MRC (1 byte)	SRC (1 byte)	MRES (1 byte)	SRES (1 byte)	Vision Sensor command code (4 bytes)
28	0F	End code		00104021

End Codes

End code (hex)	Description
0000	Command execution ended normally.
FFFF	Command execution ended in an error.

Parameter Descriptions

Filter item/position compensation item number	Specifies the item number of the filter item or position compensation item that teaching will be performed on.
---	--

● Perform Teaching (Inspection Item): 280F 00104022

This command updates the reference data for the specified inspection item.
For inspection items that have models, the model and reference data are updated.

Command Format

MRC (1 byte)	SRC (1 byte)	Vision Sensor command code (4 bytes)	Inspection item number (4 bytes)
28	0F	00104022	Inspection item number from 0 to 31 (2 digits max.)

Response Format

MRC (1 byte)	SRC (1 byte)	MRES (1 byte)	SRES (1 byte)	Vision Sensor command code (4 bytes)
28	0F	End code		00104022

End Codes

End code (hex)	Description
0000	Command execution ended normally.
FFFF	Command execution ended in an error.

Parameter Descriptions

Inspection item number	Specifies the item number of the inspection item that teaching will be performed on. (0 to 31) Only "0" can be specified with the FQ2-S1 series.
------------------------	---

● Re-register Reference Values (Position Compensation Item): 280F 00104031

This command re-registers the reference value for the specified position compensation item based on the previously loaded image.

Command Format

MRC (1 byte)	SRC (1 byte)	Vision Sensor command code (4 bytes)	Position compensation item number (4 bytes)
28	0F	00104031	Position compensation item number 0 to 7 (1 digit max.)

Response Format

MRC (1 byte)	SRC (1 byte)	MRES (1 byte)	SRES (1 byte)	Vision Sensor command code (4 bytes)
28	0F	End code		00104031

End Codes

End code (hex)	Description
0000	Command execution ended normally.
FFFF	Command execution ended in an error.

Parameter Descriptions

Position compensation item number	Specifies the item number of the position compensation item that will have its model re-registered. (0 to 7)
-----------------------------------	--

● Re-register Reference Values (Inspection Item): 280F 00104032

This command re-registers the reference values for the specified inspection item based on the previously loaded image.

Command Format

MRC (1 byte)	SRC (1 byte)	Vision Sensor command code (4 bytes)	Inspection item number (4 bytes)
28	0F	00104032	Inspection item number from 0 to 31 (2 digits max.)

Response Format

MRC (1 byte)	SRC (1 byte)	MRES (1 byte)	SRES (1 byte)	Vision Sensor command code (4 bytes)
28	0F	End code		00104032

End Codes

End code (hex)	Description
0000	Command execution ended normally.
FFFF	Command execution ended in an error.

Parameter Descriptions

Inspection item number	Specifies the item number of the inspection item that will have its reference values re-registered. (0 to 31) Only "0" can be specified with the FQ2-S1 series.
------------------------	--

● Set a Registered Image: 28F 00108010

Sets the latest image or a specified logging image as a registered image.

Registered images are saved to the following directory on the SD card or PC Tool.

\\Sensor name\\REGIMAGE*

The image specified as a registered image can be loaded as a measurement image with the Acquire Registered Image command.



Acquire Registered Image p.382

A maximum of 1000 registered images (image registration number: 0 to 999) can be set.

* For the PC Tool, the data is saved in the "\\My Documents\\OMRON FQ\\" folder.

Command Format

MRC (1 byte)	SRC (1 byte)	Vision Sensor command code (4 bytes)	Registered image number (4 bytes)	Registration source (4 bytes)	Logging image number (4 bytes)
28	0F	00108010	3 digits max.	1 digit max.	2 digits max.

Response Format

MRC (1 byte)	SRC (1 byte)	MRES (1 byte)	SRES (1 byte)	Vision Sensor command code (4 bytes)
28	0F	End code		00108010

End Codes

End code (hex)	Description
0000	Command execution ended normally.
FFFF	Command execution ended in an error.

Parameter Descriptions

Registered image number	Specifies the image to be loaded as the measurement image. The image is registered in advance with the Set a Registered Image command and assigned a number. (0 to 999)
Registration source	Specifies the image to be set as the registered image. 0: Latest measurement image 1: Sensor logging image
Logging image number	This argument is only specified when setting the Sensor's logging images as registered images. (0 to 19) If the registration source is 0: Latest measurement image, this argument is not required.

● Acquire Registered Image: 280F 00108020

This command loads a registered image saved to the SD card or PC Tool as the measurement image. The registered image is the latest image or a logging image that has been assigned a number between 0 and 999 and has been registered in advance with the Set a Registered Image command.

 Set a Registered Image p.381

Command Format

MRC (1 byte)	SRC (1 byte)	Vision Sensor command code (4 bytes)	Registered image number (4 bytes)
28	0F	00108020	3 digits max.

Response Format

MRC (1 byte)	SRC (1 byte)	MRES (1 byte)	SRES (1 byte)	Vision Sensor command code (4 bytes)
28	0F	End code		00108020

End Codes

End code (hex)	Description
0000	Command execution ended normally.
FFFF	Command execution ended in an error.

Parameter Descriptions

Registered image number	Specifies the image to be loaded as the measurement image. The image is registered in advance with the Set a Registered Image command and assigned a number. (0 to 999)
-------------------------	---

● Echo: 280F 00109010

This command returns the text string (half-width alphanumeric characters) sent by the external device as-is.

Format

MRC (1 byte)	SRC (1 byte)	Vision Sensor command code (4 bytes)	Arbitrary character string (4 bytes)
28	0F	00109010	2 words

Response Format

MRC (1 byte)	SRC (1 byte)	MRES (1 byte)	SRES (1 byte)	Vision Sensor command code (4 bytes)	Arbitrary character string (4 bytes)
28	0F	End code		00109010	2 words

End Codes

End code (hex)	Meaning
0000	Command execution ended normally.
FFFF	Command execution ended in an error.

Parameter Descriptions

Arbitrary character string	Sets the character string to be returned as is. The character string set here will be the response.
----------------------------	---

● Reset Sensor: 280F 0010F010

This command resets the Sensor.

Format

MRC (1 byte)	SRC (1 byte)	Vision Sensor command code (4 bytes)
28	0F	0010F010

Response Format

If process is completed normally, the Sensor is reset. There is therefore no response.

● Get Scene Number: 280F 00201000

This command acquires the scene number that is currently being used.

Format

MRC (1 byte)	SRC (1 byte)	Vision Sensor command code (4 bytes)
28	0F	00201000

Response Format

MRC (1 byte)	SRC (1 byte)	MRES (1 byte)	SRES (1 byte)	Vision Sensor command code (4 bytes)	Scene number (4 bytes)
28	0F	End code		00201000	Scene number that was acquired (2 digits max.)

End Codes

End code (hex)	Meaning
0000	Command execution ended normally.
FFFF	Command execution ended in an error.

Parameter Descriptions

Scene number	Returns the acquired scene number (the number of the current scene).
--------------	--

● **Acquire Communication Input Status: 280F 00207010**

This command acquires the input status (allowed/prohibited) for the communications protocol set with the Set Communication Input Status command.

Command Format

MRC (1 byte)	SRC (1 byte)	Vision Sensor command code (4 bytes)	Communications protocol type to be acquired (4 bytes)
28	0F	00207010	Communications protocol type to be acquired (1 digit max.)

Response Format

MRC (1 byte)	SRC (1 byte)	MRES (1 byte)	SRES (1 byte)	Vision Sensor command code (4 bytes)	Communications protocol status (4 bytes)
28	0F	End code		00207010	Communications protocol status

End Codes

End code (hex)	Description
0000	Command execution ended normally.
FFFF	Command execution ended in an error.

Parameter Descriptions

Communications protocol type to be acquired	Specifies the communications protocol type to be acquired. 0: No protocol (TCP, UDP, FINS) 1: No protocol (RS-232C) 2: Parallel I/O 3: Fieldbus 5: PLC link
Communications protocol status	Returns the acquired communications protocol status. 0: Input prohibited status 1: Input allowed status

● Acquire Communication Output Status: 280F 00207020

This command acquires the output status (allowed/prohibited) for all the communications protocol set with the Set Communication Output Status command.

Command Format

MRC (1 byte)	SRC (1 byte)	Vision Sensor command code (4 bytes)
28	0F	00207020

Response Format

MRC (1 byte)	SRC (1 byte)	MRES (1 byte)	SRES (1 byte)	Vision Sensor command code (4 bytes)	Acquired value (4 bytes)
28	0F	End code		00207020	Acquired value

End Codes

End code (hex)	Description
0000	Command execution ended normally.
FFFF	Command execution ended in an error.

Parameter Descriptions

Acquired value	Returns the acquired communications protocol status. 1: Output allowed status 0: Output prohibited status
----------------	---

● Acquire Terminal Status: 280F 00208010

Acquires the input signal ON/OFF status for the specified parallel I/O terminal.

Command Format

MRC (1 byte)	SRC (1 byte)	Vision Sensor command code (4 bytes)	Terminal type (4 bytes)	Terminal number (4 bytes)
28	0F	00208010	2 digits max.	1 digit max.

Response Format

MRC (1 byte)	SRC (1 byte)	MRES (1 byte)	SRES (1 byte)	Vision Sensor command code (4 bytes)	Terminal status (4 bytes)
28	0F	End code		00208010	Terminal status

End Codes

End code (hex)	Description
0000	Command execution ended normally.
FFFF	Command execution ended in an error.

Parameter Descriptions

Terminal type	<p>Specifies the type of terminal for the terminal status to be acquired.</p> <ul style="list-style-type: none"> • Sensor's standard parallel communications <ul style="list-style-type: none"> 0: TRIG 2: IN0 to IN5 • Parallel Interface Sensor Data Unit <ul style="list-style-type: none"> 0: TRIG 1: DSA 2: IN0 to IN7 13: RESET • RS-232C Interface Sensor Data Unit <ul style="list-style-type: none"> 0: TRIG 2: IN0 to IN5 13: RESET
Terminal number	<p>Specifies the terminal number for the terminal status to be acquired.</p> <ul style="list-style-type: none"> • If the terminal type is IN0 to IN5 <ul style="list-style-type: none"> 0: IN0 to 5: IN5 • If the terminal type is IN0 to IN7 <ul style="list-style-type: none"> 0: IN0 to 7: IN7 • Cases other than the above cases <ul style="list-style-type: none"> Specify 0
Terminal status	<p>Returns the ON/OFF status of the terminal.</p> <ul style="list-style-type: none"> 0: OFF 1: ON

● **Batch Acquire Terminal Statuses: 280F 00208020**

Batch acquires the ON/OFF status for the all parallel I/O input terminals other than the IN terminals.

Command Format

MRC (1 byte)	SRC (1 byte)	Vision Sensor command code (4 bytes)
28	0F	00208020

Response Format

MRC (1 byte)	SRC (1 byte)	MRES (1 byte)	SRES (1 byte)	Vision Sensor command code (4 bytes)	Terminal status (4 bytes)
28	0F	End code		00208020	Terminal status

End Codes

End code (hex)	Description
0000	Command execution ended normally.
FFFF	Command execution ended in an error.

Parameter Descriptions

Terminal type	<p>Returns the acquired terminal status as a decimal value. (ON: 1, OFF: 0) (0 to 31)</p> <p>BIT0: TRIG BIT1: DSA BIT4: RESET</p> <p>For example, when DSA is ON 2 is returned.</p>
---------------	---

● **Batch Acquire IN Terminal Statuses: 280F 00208030**

Batch acquires the ON/OFF status for the IN terminals.

Command Format

MRC (1 byte)	SRC (1 byte)	Vision Sensor command code (4 bytes)
28	0F	00208030

Response Format

MRC (1 byte)	SRC (1 byte)	MRES (1 byte)	SRES (1 byte)	Vision Sensor command code (4 bytes)	Terminal status (4 bytes)
28	0F	End code		00208030	Terminal status

End Codes

End code (hex)	Description
0000	Command execution ended normally.
FFFF	Command execution ended in an error.

Parameter Descriptions

Terminal type	<p>Returns the acquired terminal status as a decimal value. (ON: 1, OFF: 0) (0 to 255)</p> <p>BIT0: IN0 BIT1: IN1 BIT2: IN2 BIT3: IN3 BIT4: IN4 BIT5: IN5 BIT6: IN6 BIT7: IN7</p> <p>For example, when IN0 and IN4 are ON 17 is returned.</p>
---------------	---

● Acquire Execution Mode: 280F 0020F000

Acquires the FQ2 execution status (execution mode).

Command Format

MRC (1 byte)	SRC (1 byte)	Vision Sensor command code (4 bytes)
28	0F	0020F000

Response Format

MRC (1 byte)	SRC (1 byte)	MRES (1 byte)	SRES (1 byte)	Vision Sensor command code (4 bytes)	Execution mode (4 bytes)
28	0F	End code		0020F000	Execution mode

End Codes

End code (hex)	Description
0000	Command execution ended normally.
FFFF	Command execution ended in an error.

Parameter Descriptions

Execution mode	This command acquires the FQ2 execution mode*. 1: Run mode 2: Stop mode 10: Adjust mode 11: IO monitor setup mode
----------------	---

- * The execution mode is classified into the following modes depending on the FQ2 execution status.
- Run mode: The mode to run actual measurements. I/O is possible with external devices such as a PLC.
 - Stop mode: This mode is for monitoring/controlling the output status of the parallel signals through communication commands only. Therefore, I/O that is unrelated to parallel terminal control is not possible.
 - Input: Parallel signal input is not possible. Command input is not possible. (However, the terminal status monitor, setting commands can be used)
 - Output: Parallel signal output is possible. Data output is not possible.
 - Adjust mode: The status where Touch Finder is connected and the Setup display is displayed. This mode is for configuring settings and making adjustments, so measurement processing, I/O signals from external devices, and command input are not possible.
 - IO monitor setup mode: The status where Touch Finder is connected and the IO monitor in the Setup display is displayed.

● Change Scene Number: 280F 00301000

This command changes the scene number to use.

Format

MRC (1 byte)	SRC (1 byte)	Vision Sensor command code (4 bytes)	Scene number (4 bytes)
28	0F	00301000	Scene number to change to (2 digits max.)

Response Format

MRC (1 byte)	SRC (1 byte)	MRES (1 byte)	SRES (1 byte)	Vision Sensor command code (4 bytes)
28	0F	End code		00301000

End Codes

End code (hex)	Meaning
0000	Command execution ended normally.
FFFF	Command execution ended in an error.

Parameter Descriptions

Scene number	Specifies the scene number (0 to 31) to change to.
--------------	--

● Set Communication Input Status: 280F 00307010

This command sets the input status (allowed/prohibited) of the communications port for the specified communications protocol.

Communications protocols with the input status set to prohibited will no longer receive communications after being set as such.

However, for inputs related to hardware (parallel TRIG signal and DSA signal), this setting is not applicable.

Command Format

MRC (1 byte)	SRC (1 byte)	Vision Sensor command code (4 bytes)	Communications protocol type to be set (4 bytes)	Setting value (4 bytes)
28	0F	00307010	Communications protocol type to be set (1 digit max.)	Communications protocol status to be set (1 digit max.)

Response Format

MRC (1 byte)	SRC (1 byte)	MRES (1 byte)	SRES (1 byte)	Vision Sensor command code (4 bytes)
28	0F	End code		00307010

End Codes

End code (hex)	Description
0000	Command execution ended normally.
FFFF	Command execution ended in an error.

Parameter Descriptions

Communications protocol type to be set	Specifies the type of communications protocol to be set. 0: No protocol (TCP, UDP, FINS) 1: No protocol (RS-232C) 2: Parallel I/O 3: Fieldbus 5: PLC link
Setting value	Sets the status of the communications protocol. 0: Input prohibited status 1: Input allowed status

● Set Communication Output Status: 280F 00307020

This command sets the output status (allowed/prohibited) for all the communications protocol. Communications protocols with the output status set to prohibited will no longer output signals after being set as such.

Command Format

MRC (1 byte)	SRC (1 byte)	Vision Sensor command code (4 bytes)	Communications protocol status to be set (4 bytes)
28	0F	00307020	Communications protocol status to be set (1 digit max.)

Response Format

MRC (1 byte)	SRC (1 byte)	MRES (1 byte)	SRES (1 byte)	Vision Sensor command code (4 bytes)
28	0F	End code		00307020

End Codes

End code (hex)	Description
0000	Command execution ended normally.
FFFF	Command execution ended in an error.

Parameter Descriptions

Communications protocol status to be set	Specifies the communications protocol status to be set. 0: Output prohibited status 1: Output allowed status
--	--

● Set Terminal Status: 280F 00308010

This command sets the output signal ON/OFF status for the specified parallel I/O terminal.

Note

When turning the parallel terminals ON or OFF with this command, there are terminals that cannot be controlled if the FQ2 execution mode is not set to stop mode.

In this case, first change the FQ2 execution mode to stop mode with the Set Execution Mode command, and then execute this command.



Set Execution Mode: p.398

Command Format

MRC (1 byte)	SRC (1 byte)	Vision Sensor command code (4 bytes)	Terminal type (4 bytes)	Terminal number (4 bytes)	Terminal status (4 bytes)
28	0F	00308010	2 digits max.	1 digit max.	1 digit max.

Response Format

MRC (1 byte)	SRC (1 byte)	MRES (1 byte)	SRES (1 byte)	Vision Sensor command code (4 bytes)
28	0F	End code		00308010

End Codes

End code (hex)	Description
0000	Command execution ended normally.
FFFF	Command execution ended in an error.

Parameter Descriptions

Terminal type	<p>Specifies the type of terminal for the terminal status to be set.</p> <ul style="list-style-type: none"> • Sensor's standard parallel communications <ul style="list-style-type: none"> 4: ERROR 5: BUSY 6: OR • Parallel Interface Sensor Data Unit <ul style="list-style-type: none"> 3: RUN 4: ERROR 5: BUSY 6: OR^{*1} 7: GATE^{*1} 9: D0 to D15^{*1} 10: STGOUT^{*1} 11: SHTOUT^{*1} 12: ACK^{*1} • RS-232C Interface Sensor Data Unit <ul style="list-style-type: none"> 3: RUN 4: ERROR 5: BUSY 6: OR^{*1} 10: STGOUT^{*1} 11: SHTOUT^{*1} 12: ACK^{*1}
Terminal number	<p>Specifies the terminal number for the terminal status to be set.</p> <ul style="list-style-type: none"> • If the terminal type is D0 to D15 <ul style="list-style-type: none"> 0: D0 to 15: D15 • Cases other than the above cases <ul style="list-style-type: none"> Specify 0
Terminal status	<p>Specifies the ON/OFF status for the terminal.</p> <ul style="list-style-type: none"> 0: OFF 1: ON

*1 These terminals status can only be set when the FQ2 execution mode is stop mode.

● Batch Set Terminal Statuses: 280F 00308020

Batch sets the ON/OFF status for the all parallel I/O output terminals other than the D terminals (D0 to D15).

Important

- Before executing this command, change the FQ2 execution mode to stop mode with the Set Execution Mode command.
- If the FQ2 is not in stop mode, some parallel terminals cannot be turned ON or OFF with this command.



Set Execution Mode: p.398

Command Format

MRC (1 byte)	SRC (1 byte)	Vision Sensor command code (4 bytes)	Terminal status (4 bytes)
28	0F	00308020	5 digits max.

Response Format

MRC (1 byte)	SRC (1 byte)	MRES (1 byte)	SRES (1 byte)	Vision Sensor command code (4 bytes)
28	0F	End code		00308020

End Codes

End code (hex)	Description
0000	Command execution ended normally.
FFFF	Command execution ended in an error.

Parameter Descriptions

Terminal status	<p>Specifies the ON/OFF status for the terminals as a decimal value. (ON: 1, OFF: 0) (0 to 16,383)</p> <ul style="list-style-type: none"> • Sensor's standard parallel communications <ul style="list-style-type: none"> BIT1: ERROR BIT2: BUSY BIT3: OR • Parallel Interface Sensor Data Unit <ul style="list-style-type: none"> BIT0: RUN BIT1: ERROR BIT2: BUSY BIT3: OR*1 BIT5: GATE*1 BIT9: STGOUT*1 BIT11: SHTOUT*1 BIT13: ACK*1 • RS-232C Interface Sensor Data Unit <ul style="list-style-type: none"> BIT0: RUN BIT1: ERROR BIT2: BUSY BIT3: OR*1 BIT9: STGOUT*1 BIT11: SHTOUT*1 BIT13: ACK*1 <p>For example, to turn ON OR Specify 8.</p>
-----------------	---

*1 These terminals status can only be set when the FQ2 execution mode is stop mode.

● Batch Set D Terminal Statuses: 280F 00308030

Batch sets the ON/OFF status for the D terminals (D0 to D15).

Important

Before executing this command, change the FQ2 execution mode to stop mode with the Set Execution Mode command.



Set Execution Mode: p.398

Command Format

MRC (1 byte)	SRC (1 byte)	Vision Sensor command code (4 bytes)	Terminal status (4 bytes)
28	0F	00308030	5 digits max.

Response Format

MRC (1 byte)	SRC (1 byte)	MRES (1 byte)	SRES (1 byte)	Vision Sensor command code (4 bytes)
28	0F	End code		00308030

End Codes

End code (hex)	Description
0000	Command execution ended normally.
FFFF	Command execution ended in an error.

Parameter Descriptions

Terminal status	Specifies the ON/OFF status for the terminal. (ON: 1, OFF: 0) (0 to 65,535) BIT0: D0 BIT1: D1 BIT2: D2 BIT3: D3 BIT4: D4 BIT5: D5 BIT6: D6 BIT7: D7 BIT8: D8 BIT9: D9 BIT10: D10 BIT11: D11 BIT12: D12 BIT13: D13 BIT14: D14 BIT15: D15
-----------------	---

● Set Execution Mode: 280F 0030F000

Sets the FQ2 execution status (execution mode).

Note

When using commands (Set Terminal Status/Batch Set Terminal Status/Batch Set DO Status) to control the ON/OFF status of the parallel I/O terminals with communication commands, change the FQ2 to stop mode with this command.

Command Format

MRC (1 byte)	SRC (1 byte)	Vision Sensor command code (4 bytes)	Execution mode (4 bytes)
28	0F	0030F000	Execution mode (2 digits max.)

Response Format

MRC (1 byte)	SRC (1 byte)	MRES (1 byte)	SRES (1 byte)	Vision Sensor command code (4 bytes)
28	0F	End code		0030F000

End Codes

End code (hex)	Description
0000	Command execution ended normally.
FFFF	Command execution ended in an error.

Parameter Descriptions

Execution mode	Specifies the FQ2 execution mode ^{*1} to be set. 1: Run mode 2: Stop mode
----------------	--

- *1 The execution mode is classified into the following modes depending on the FQ2 execution status.
- Run mode: The mode to run actual measurements. I/O is possible with external devices such as a PLC.
 - Stop mode: This mode is for monitoring/controlling the output status of the parallel signals through communication commands only. Therefore, I/O that is unrelated to parallel terminal control is not possible.
 - Input: Parallel signal input is not possible. Command input is not possible. (However, the terminal status monitor, setting commands can be used)
 - Output: Parallel signal output is possible. Data output is not possible.

● Get Image Adjustment Data: 280F 00401010

This command acquires parameters or measurement values from a position compensation item or filter item.

Format

MRC (1 byte)	SRC (1 byte)	Vision Sensor command code (4 bytes)	Position compensation item/filter item number (4 bytes)	External reference number (4 bytes)
28	0F	00401010	Position compensation item/filter item number 0 to 7 (1 digit max.)	External reference number

Response Format

MRC (1 byte)	SRC (1 byte)	MRES (1 byte)	SRES (1 byte)	Vision Sensor command code (4 bytes)	Acquired value (4 bytes)
28	0F	End code		00401010	Acquired value (1,000 times the actual value)

End Codes

End code (hex)	Meaning
0000	Command execution ended normally.
FFFF	Command execution ended in an error.

Parameter Descriptions

Position compensation item number	Specifies the number of the position compensation item or filter item for which to acquire the data. (0 to 7)
External reference num- ber	Specifies the external reference number. <input type="checkbox"/> Section 9-2 External Reference Parameters in Vision Sensor FQ2-S/CH Series User's Manual (Cat. No. Z337)
Acquired value	Returns the image adjustment data or threshold value. <input type="checkbox"/> Section 9-2 External Reference Parameters in Vision Sensor FQ2-S/CH Series User's Manual (Cat. No. Z337)

● Get the Inspection Item Data: 280F 00401020

This command acquires the parameters and measurement values of the specified inspection item.

Format

MRC (1 byte)	SRC (1 byte)	Vision Sensor command code (4 bytes)	Inspection item number (4 bytes)	External reference number (4 bytes)
28	0F	00401020	Inspection item number (2 digits max.)	External reference number

Response Format

MRC (1 byte)	SRC (1 byte)	MRES (1 byte)	SRES (1 byte)	Vision Sensor command code (4 bytes)	Acquired value (4 bytes)
28	0F	End code		00401020	Acquired value (1,000 times the actual value)

End Codes

End code (hex)	Meaning
0000	Command execution ended normally.
FFFF	Command execution ended in an error.

Parameter Descriptions

Inspection item number	Specifies the number of the inspection item for which to acquire the data. (0 to 31)
External reference number	Specifies the external reference number. <input type="checkbox"/> Section 9-2 External Reference Parameters in Vision Sensor FQ2-S/CH Series User's Manual (Cat. No. Z337)
Acquired value	Returns the data for the specified inspection item. <input type="checkbox"/> Section 9-2 External Reference Parameters in Vision Sensor FQ2-S/CH Series User's Manual (Cat. No. Z337)

● Get Version Information: 280F 00403000

This command acquires the version information of the Sensor software.

Format

MRC (1 byte)	SRC (1 byte)	Vision Sensor command code (4 bytes)
28	0F	00403000

Response Format

MRC (1 byte)	SRC (1 byte)	MRES (1 byte)	SRES (1 byte)	Vision Sensor command code (4 bytes)	Software version text string (4 bytes)
28	0F	End code		00403000	Software version (1,000 times the actual value)

End Codes

End code (hex)	Meaning
0000	Command execution ended normally.
FFFF	Command execution ended in an error.

Parameter Descriptions

Software version text string	Returns the software version. Example: When the software version is 1.20, the response is 1200 (4B0 hex).
------------------------------	--

● Acquire Camera Parameter: 280F 00401040

This command acquires the value of the specified camera parameter.

 Camera parameter numbers: p. 219

Command Format

MRC (1 byte)	SRC (1 byte)	Vision Sensor command code (4 bytes)	Camera parameter number (4 bytes)
28	0F	00401040	3 digits max.

Response Format

MRC (1 byte)	SRC (1 byte)	MRES (1 byte)	SRES (1 byte)	Vision Sensor command code (4 bytes)	Acquired value (4 bytes)
28	0F	End code		00401040	Dependent on the camera parameter (1,000 times the actual value)

End Codes

End code (hex)	Description
0000	Command execution ended normally.
FFFF	Command execution ended in an error.

Parameter Descriptions

Camera parameter number	Specifies the number that corresponds to the camera parameter to be acquired.
Acquired value	Returns the specified camera parameter.

● Acquire System Data: 280F 00404010

This command acquires the value set for the specified system data.

 System data numbers and details: p. 222

Command Format

MRC (1 byte)	SRC (1 byte)	Vision Sensor command code (4 bytes)	System data number (4 bytes)
28	0F	00404010	3 digits max.

Response Format

MRC (1 byte)	SRC (1 byte)	MRES (1 byte)	SRES (1 byte)	Vision Sensor command code (4 bytes)	Acquired value (4 bytes)
28	0F	End code		00404010	Dependent on the system data (1,000 times the actual value)

End Codes

End code (hex)	Description
0000	Command execution ended normally.
FFFF	Command execution ended in an error.

Parameter Descriptions

System data number*	Specifies the number that corresponds to the system data to be acquired.
Acquired value	Returns the specified system data.

● Acquire Terminal Offset Data: 280F 00404060

This command acquires the terminal offset data that is added to the IN0 to IN4 command parameters when executing parallel commands

If no value has been set with the Set Terminal Offset command, "00000" is returned as the terminal offset value and "0000" (ended normally) is returned for the end code.

 Set Terminal Offset Data: 280F 00504060 p. 411

Command Format

MRC (1 byte)	SRC (1 byte)	Vision Sensor command code (4 bytes)
28	0F	00404060

Response Format

MRC (1 byte)	SRC (1 byte)	MRES (1 byte)	SRES (1 byte)	Vision Sensor command code (4 bytes)	Terminal offset value (4 bytes)
28	0F	End code		00404060	Terminal offset value

End Codes

End code (hex)	Description
0000	Command execution ended normally.
FFFF	Command execution ended in an error.

Parameter Descriptions

Terminal offset value	Returns the value added to the IN0 to IN4 command parameters when executing parallel commands.
-----------------------	--

● Acquire Statistical Data: 280F 00406010

Acquires the statistical data (such as the number of measurements, number of NG overall judgments, and other information, since the power supply was turned ON) possessed by the Sensor.

The following types of statistical data are available. Specify the data to be read from these types with this command.

- Number of measurements since the power supply was turned ON
- Number of OK overall judgments
- NG rate
- Number of NG judgments since the power supply was turned ON
- OK rate

Command Format

MRC (1 byte)	SRC (1 byte)	Vision Sensor command code (4 bytes)	Type of statistical data to be acquired (4 bytes)
28	0F	00406010	1 digit max.

Response Format

MRC (1 byte)	SRC (1 byte)	MRES (1 byte)	SRES (1 byte)	Vision Sensor command code (4 bytes)	Acquired value (4 bytes)
28	0F	End code		00406010	Acquired value (1,000 times the actual value)

End Codes

End code (hex)	Description
0000	Command execution ended normally.
FFFF	Command execution ended in an error.

Parameter Descriptions

Type of statistical data to be acquired	Specifies the type of statistical data to be acquired. 1: Number of measurements 2: Number of NG judgments 3: NG rate 4: Number of OK judgments 5: OK rate
Acquired value	Returns the value of the acquired statistical data.

● Get Error Information: 280F 00205000

This command acquires the latest error code from the Sensor.

Format

MRC (1 byte)	SRC (1 byte)	Vision Sensor command code (4 bytes)
28	0F	00205000

Response Format

MRC (1 byte)	SRC (1 byte)	MRES (1 byte)	SRES (1 byte)	Vision Sensor command code (4 bytes)	Error code (4 bytes)
28	0F	End code		00205000	Error code

Parameter Descriptions

Error code	Returns the latest error code. If there is no error record, the response is 00000000. <input type="checkbox"/> Section 9 Appendices in Vision Sensor FQ2-S/CH Series User's Manual (Cat. No. Z337)
------------	---

● Set Image Adjustment Data: 280F 00501010

This command sets parameters or measurement ranges from a position compensation item or filter item.

Format

MRC (1 byte)	SRC (1 byte)	Vision Sensor command code (4 bytes)	Position compensation item/filter item number (4 bytes)	External reference number (4 bytes)	Set value (4 bytes)
28	0F	00501010	Position compensation item/filter item number 0 to 7 (1 digit max.)	External reference number	Setting value (1,000 times the actual value)

Response Format

MRC (1 byte)	SRC (1 byte)	MRES (1 byte)	SRES (1 byte)	Vision Sensor command code (4 bytes)
28	0F	End code		00501010

End Codes

End code (hex)	Meaning
0000	Command execution ended normally.
FFFF	Command execution ended in an error.

Parameter Descriptions

Position compensation item number	Specifies the number of the position compensation item or filter item to set. (0 to 31)
External reference number	Specifies the external reference number. <input type="checkbox"/> Section 9-2 External Reference Parameters in Vision Sensor FQ2-S/CH Series User's Manual (Cat. No. Z337)
Set value	Specifies the set value. <input type="checkbox"/> Section 9-2 External Reference Parameters in Vision Sensor FQ2-S/CH Series User's Manual (Cat. No. Z337)

● Set Inspection Item Data: 280F 00501020

This command sets the parameters and measurement ranges of the specified inspection item.

Format

MRC (1 byte)	SRC (1 byte)	Vision Sensor command code (4 bytes)	Inspection item number (4 bytes)	External reference number (4 bytes)	Set value (4 bytes)
28	0F	00501020	Inspection item number from 00 to 1F (2 digits max.)	External reference number	Set value (1,000 times the actual value)

Response Format

MRC (1 byte)	SRC (1 byte)	MRES (1 byte)	SRES (1 byte)	Vision Sensor command code (4 bytes)
28	0F	End code		00501020

End Codes

End code (hex)	Meaning
0000	Command execution ended normally.
FFFF	Command execution ended in an error.

Parameter Descriptions

Inspection item number	Specifies the number of the inspection item to set. (0 to 31)
External reference number	Specifies the external reference number. <input type="checkbox"/> Section 9-2 External Reference Parameters in Vision Sensor FQ2-S/CH Series User's Manual (Cat. No. Z337)
Setting	Specifies the set value. <input type="checkbox"/> Section 9-2 External Reference Parameters in Vision Sensor FQ2-S/CH Series User's Manual (Cat. No. Z337)

● Set Camera Parameter: 280F 00501040

Sets the value for the specified camera parameter.

 Camera parameter numbers: p. 219

Command Format

MRC (1 byte)	SRC (1 byte)	Vision Sensor command code (4 bytes)	Camera parameter number (4 bytes)	Setting value (4 bytes)
28	0F	00501040	3 digits max.	Dependent on the camera parameter (1,000 times the actual value)

Response Format

MRC (1 byte)	SRC (1 byte)	MRES (1 byte)	SRES (1 byte)	Vision Sensor command code (4 bytes)
28	0F	End code		00501040

End Codes

End code (hex)	Description
0000	Command execution ended normally.
FFFF	Command execution ended in an error.

Parameter Descriptions

Camera parameter number	Specifies the number that corresponds to the camera parameter to be set.
Setting value	Specifies the setting value to be set to the camera parameter.

● Set System Data: 280F 00504010

Sets the value to the specified system data.

 System data numbers and details: p. 222

Command Format

MRC (1 byte)	SRC (1 byte)	Vision Sensor command code (4 bytes)	System data number (4 bytes)	Setting value (4 bytes)
28	0F	00504010	3 digits max.	Dependent on the system data (1,000 times the actual value)

Response Format

MRC (1 byte)	SRC (1 byte)	MRES (1 byte)	SRES (1 byte)	Vision Sensor command code (4 bytes)
28	0F	End code		00504010

End Codes

End code (hex)	Description
0000	Command execution ended normally.
FFFF	Command execution ended in an error.

Parameter Descriptions

System data number*	Specifies the number that corresponds to the system data to be set.
Setting value	Specifies the setting value to be set to the system data.

● Set Terminal Offset Data: 280F 00504060

This command sets the value of the terminal offset data that is added to the IN0 to IN4 command parameters when executing parallel commands.

When using parallel command scene changing, you can change the scenes to change to by changing the Set Terminal Offset Data value.

Note

When using the Sensor in Expanded Mode while using the standard parallel interface of the Sensor, the range of scene numbers that can be changed to with scene changing is limited to 0 through 15. By offsetting the command parameter with this command, the scene can be changed to scene number 0 through 31.

Command Format

MRC (1 byte)	SRC (1 byte)	Vision Sensor command code (4 bytes)	Terminal offset value (4 bytes)
28	0F	00504060	2 digits max.

Response Format

MRC (1 byte)	SRC (1 byte)	MRES (1 byte)	SRES (1 byte)	Vision Sensor command code (4 bytes)
28	0F	End code		00504060

End Codes

End code (hex)	Description
0000	Command execution ended normally.
FFFF	Command execution ended in an error.

Parameter Descriptions

Terminal offset value	Specifies the value to be added to the IN0 to IN4 command parameters when executing parallel commands.
-----------------------	--

Load Setting Data Commands

● Load Scene Data: 280F 00601000

Loads scene data that is stored on the SD card inserted in the Touch Finder.

The source for scene data is the following fixed directory on the SD card.

\\Sensor name\\SCN

Format

MRC (1 byte)	SRC (1 byte)	Vision Sensor command code (4 bytes)	Scene number (4 bytes)	Scene data file name (4 to 64 bytes)
28	0F	00601000	2 digits max.	64 characters max.

Response Format

MRC (1 byte)	SRC (1 byte)	MRES (1 byte)	SRES (1 byte)	Vision Sensor command code (4 bytes)
28	0F	End code		00601000

End Codes

End code (hex)	Meaning
0000	Command execution ended normally.
FFFF	Command execution ended in an error.

Parameter Descriptions

Scene number	Specifies the scene number (0 to 31) to be loaded
Scene data file name	Specifies the scene data file name you want to load. Only files with the extension "SCN" can be loaded.

Important

Do not turn off power to the Vision Sensor until there is a response.

● Load All Scene Data: 280F 00602000

Loads all scene data that is stored on the SD card inserted in the Touch Finder.

The source for all scene data is the following fixed directory on the SD card.

\\Sensor name\\SGP

Format

MRC (1 byte)	SRC (1 byte)	Vision Sensor command code (4 bytes)	Scene group number (4 bytes)	Scene group data file name (4 to 64 bytes)
28	0F	00602000	2 digits max.	64 characters max.

Response Format

MRC (1 byte)	SRC (1 byte)	MRES (1 byte)	SRES (1 byte)	Vision Sensor command code (4 bytes)
28	0F	End code		00602000

End Codes

End code (hex)	Meaning
0000	Command execution ended normally.
FFFF	Command execution ended in an error.

Parameter Descriptions

Scene group data file name (all scene data file name)	Specifies the all scene data file name to be loaded. The file name extension (.sgp) can be omitted. Specifies the scene group number (0 to 31) to be loaded.
---	--

Important

Do not turn off power to the Vision Sensor until there is a response.

● Load System Data: 280F 00603000

This command loads system data that is stored on the SD card inserted in the Touch Finder. The source for system data is the following fixed directory on the SD card.
\Sensor name\SYD

Format

MRC (1 byte)	SRC (1 byte)	Vision Sensor command code (4 bytes)	System data file name (4 to 64 bytes)
28	0F	00603000	64 characters max.

Response Format

MRC (1 byte)	SRC (1 byte)	MRES (1 byte)	SRES (1 byte)	Vision Sensor command code (4 bytes)
28	0F	End code		00603000

End Codes

End code (hex)	Meaning
0000	Command execution ended normally.
FFFF	Command execution ended in an error.

Parameter Descriptions

System data file name	Specifies the system data file name to be loaded. The file name extension (.syd) can be omitted.
-----------------------	---

Important

Do not turn off power to the Vision Sensor until there is a response.

● Load All Setting Data: 280F 00605000

This command loads all setting data (all scene data, system data, calibration group data) for the Sensor saved as a backup file from the SD card inserted in the Touch Finder.

The source for backup files is the following fixed directory on the SD card.

\Sensor name\BKD

Format

MRC (1 byte)	SRC (1 byte)	Vision Sensor command code (4 bytes)	All setting data backup file name (4 to 64 bytes)
28	0F	00605000	64 characters max.

Response Format

MRC (1 byte)	SRC (1 byte)	MRES (1 byte)	SRES (1 byte)	Vision Sensor command code (4 bytes)
28	0F	End code		00605000

End Codes

End code (hex)	Meaning
0000	Command execution ended normally.
FFFF	Command execution ended in an error.

Parameter Descriptions

All setting data backup file name	Specifies the all configuration data backup file name to be loaded. The file name extension (.bkd) can be omitted.
-----------------------------------	---

Important

Do not turn off power to the Vision Sensor until there is a response.

● Load Calibration Data: 280F 0060A000

This command loads calibration data that is stored on the SD card inserted in the Touch Finder as the calibration data with the specified number.

The source for calibration data is the following fixed directory on the SD card.

\\Sensor name\\CLB

Format

MRC (1 byte)	SRC (1 byte)	Vision Sensor command code (4 bytes)	Calibration number (4 bytes)	Calibration data file name (4 to 64 bytes)
28	0F	0060A000	2 digits max.	64 characters max.

Response Format

MRC (1 byte)	SRC (1 byte)	MRES (1 byte)	SRES (1 byte)	Vision Sensor command code (4 bytes)
28	0F	End code		0060A000

End Codes

End code (hex)	Description
0000	Command execution ended normally.
FFFF	Command execution ended in an error.

Parameter Descriptions

Calibration number	Specifies the calibration number you want to load. (0 to 31)
Calibration data file name	Specifies the calibration data file name you want to load. The file name extension (.clb) can be omitted.

Important

Do not turn off power to the Vision Sensor until there is a response.

● Load All Calibration Data: 280F 0060B000

This command loads all calibration data that is stored on the SD card inserted in the Touch Finder. The source for all calibration data is the following fixed directory on the SD card.
\\Sensor name\\CGP

Format

MRC (1 byte)	SRC (1 byte)	Vision Sensor command code (4 bytes)	All scene data file name (4 to 64 bytes)
28	0F	0060B000	64 characters max.

Response Format

MRC (1 byte)	SRC (1 byte)	MRES (1 byte)	SRES (1 byte)	Vision Sensor command code (4 bytes)
28	0F	End code		0060B000

End Codes

End code (hex)	Description
0000	Command execution ended normally.
FFFF	Command execution ended in an error.

Parameter Descriptions

All calibration data name	Specifies the all calibration data file name to be loaded. The file name extension (.cgp) can be omitted.
---------------------------	--

Important

Do not turn off power to the Vision Sensor until there is a response.

● Load Model Dictionary Number Data: 280F 0060C000

This command loads model dictionary data that is stored on the SD card inserted in the Touch Finder as the specified model dictionary number.

The source for calibration data is the following fixed directory on the SD card.

\Sensor name\DIC

Format

MRC (1 byte)	SRC (1 byte)	Vision Sensor command code (4 bytes)	Model dictionary number (4 bytes)	Model dictionary data file name (4 to 64 bytes)
28	0F	0060C000	2 digits max.	64 characters max.

Response Format

MRC (1 byte)	SRC (1 byte)	MRES (1 byte)	SRES (1 byte)	Vision Sensor command code (4 bytes)
28	0F	End code		0060C000

End Codes

End code (hex)	Description
0000	Command execution ended normally.
FFFF	Command execution ended in an error.

Parameter Descriptions

Model dictionary number	Specifies the model dictionary number you want to load. (0 to 31)
Model dictionary data file name	Specifies the model dictionary data file name you want to load. The file name extension (.dic) can be omitted.

Important

Do not turn off power to the Vision Sensor until there is a response.

● Load All Model Dictionary Data: 280F 0060D000

This command loads all model dictionary data that is stored on the SD card inserted in the Touch Finder. The source for all model dictionary data is the following fixed directory on the SD card.

\\Sensor name\DGP

Format

MRC (1 byte)	SRC (1 byte)	Vision Sensor command code (4 bytes)	All model dictionary data file name (4 to 64 bytes)
28	0F	0060D000	64 characters max.

Response Format

MRC (1 byte)	SRC (1 byte)	MRES (1 byte)	SRES (1 byte)	Vision Sensor command code (4 bytes)
28	0F	End code		0060D000

End Codes

End code (hex)	Description
0000	Command execution ended normally.
FFFF	Command execution ended in an error.

Parameter Descriptions

All model dictionary data file name	Specifies the all model dictionary data file name to be saved. The file name extension (.dgp) can be omitted.
-------------------------------------	---

Important

Do not turn off power to the Vision Sensor until there is a response.

Save Configuration Data Commands

● Save Scene Data: 280F 00701000

This command saves scene data to the SD card inserted in the Touch Finder as a file. The destination for scene data is the following fixed directory on the SD card.

\\Sensor name\\SCN

Format

MRC (1 byte)	SRC (1 byte)	Vision Sensor command code (4 bytes)	Save scene number (4 bytes)	Scene data file name (4 to 64 bytes)
28	0F	00701000	2 digits max.	64 characters max.

Response Format

MRC (1 byte)	SRC (1 byte)	MRES (1 byte)	SRES (1 byte)	Vision Sensor command code (4 bytes)
28	0F	End code		00701000

End Codes

End code (hex)	Meaning
0000	Command execution ended normally.
FFFF	Command execution ended in an error.

Parameter Descriptions

Scene number	Specifies the scene number (0 to 31) to be saved.
Scene data file name	Specifies the file name when saving. The file name extension (.scn) can be omitted.

Important

- If the specified file name already exists, this existing file will be overwritten.
- Do not turn off power to the Vision Sensor until there is a response.

● Save Scene Group Data: 280F 00702000

This command saves all scene data as a file to the SD card inserted in the Touch Finder. The destination for all scene data is the following fixed directory on the SD card.
\\Sensor name\\SGP

Format

MRC (1 byte)	SRC (1 byte)	Vision Sensor command code (4 bytes)	Save scene group number (4 bytes)	All scene data file name (4 to 64 bytes)
28	0F	00702000	2 digits max.	64 characters max.

Response Format

MRC (1 byte)	SRC (1 byte)	MRES (1 byte)	SRES (1 byte)	Vision Sensor command code (4 bytes)
28	0F	End code		00702000

End Codes

End code (hex)	Meaning
0000	Command execution ended normally.
FFFF	Command execution ended in an error.

Parameter Descriptions

All scene data file name	Specifies the all scene data file name to save. The file name extension (.sgp) can be omitted.
--------------------------	---

Important

- If the specified file name already exists, this existing file will be overwritten.
- Do not turn off power to the Vision Sensor until there is a response.

● Save System Data: 280F 00703000

Saves system data as a file to the SD card inserted in the Touch Finder.
The destination for system data is the following fixed directory on the SD card.
\\Sensor name\\SYD

Format

MRC (1 byte)	SRC (1 byte)	Vision Sensor command code (4 bytes)	System data file name (4 to 64 bytes)
28	0F	00703000	64 characters max.

Response Format

MRC (1 byte)	SRC (1 byte)	MRES (1 byte)	SRES (1 byte)	Vision Sensor command code (4 bytes)
28	0F	End code		00703000

End Codes

End code (hex)	Meaning
0000	Command execution ended normally.
FFFF	Command execution ended in an error.

Parameter Descriptions

System data file name	Specifies the system data file name. The file name extension (.syd) can be omitted.
-----------------------	--

Important

Do not turn off power to the Vision Sensor until there is a response.

● Save Image Data: 280F 00704000

Saves image data saved in the Sensor's memory by the logging function to the SD card inserted in the Touch Finder as ifz data.

The destination for image data is the following fixed directory on the SD card.

\Sensor name\LOGIMAGE\Number*

* Number is a five digit number starting from 00000. The images are saved in increments of 100 images for each number, and when there are over 100 images, the directory with the next number is created.

Format

MRC (1 byte)	SRC (1 byte)	Vision Sensor command code (4 bytes)	Image data file name (4 to 64 bytes)
28	0F	00704000	64 characters max.

Response Format

MRC (1 byte)	SRC (1 byte)	MRES (1 byte)	SRES (1 byte)	Vision Sensor command code (4 bytes)
28	0F	End code		00704000

End Codes

End code (hex)	Meaning
0000	Command execution ended normally.
FFFF	Command execution ended in an error.

Parameter Descriptions

Image data number	Specifies the number of the image data to be saved. The maximum number of logged images is 20 (image data number: 0 to 19). The image data number of the latest image is 0.
Image data file name	Specifies the image data file name when saving. (64 characters max.) The file name extension (.ifz) can be omitted.

Important

- If the same file is specified as an existing file, the existing file will be overwritten.
- Do not turn off power to the Vision Sensor until there is a response.

● Save All Image Data: 280F 00704010

This command saves all image data saved in the Sensor's memory by the logging function to the SD card inserted in the Touch Finder as ifz data.

The destination for logging image data is the following fixed directory on the SD card.

\Sensor name\LOGIMAGE\Number*

* Number is a five digit number starting from 00000. The images are saved in increments of 100 images for each number, and when there are over 100 images, the directory with the next number is created.

Format

MRC (1 byte)	SRC (1 byte)	Vision Sensor command code (4 bytes)
28	0F	00704010

Response Format

MRC (1 byte)	SRC (1 byte)	MRES (1 byte)	SRES (1 byte)	Vision Sensor command code (4 bytes)
28	0F	End code		00704010

End Codes

End code (hex)	Meaning
0000	Command execution ended normally.
FFFF	Command execution ended in an error.

Image Data File Names

Image data file names are automatically created as follows.

img_ScnNNN_YYYY_MM_DD-HH_mm_ss(S)_TTTT_XX.ifz

img	Prefix string. The string can be set as desired with the following setting. ▶  (Setup Mode or Run Mode) – [TF settings] – [File format]
ScnNNN	Scn + measured scene number (0 to 31)
YYYY_MM_DD	Date that the image data was saved to the Touch Finder SD card* ¹
HH_mm_ss	Time that the image data was saved to the Touch Finder SD card* ¹
(S)	Image data number (0 to 19) Image data number of the latest image is 0.
TTTT	Number of measurements since the Sensor was started. Reset when the power supply is turned OFF. (0000 to 9999)
XX	Total judgment (OK/NG)

*¹ The date and time are not recorded in the image data. Therefore, this is not the date and time that the measurement was performed, this is the date and time the image data file was saved from the Sensor to the Touch Finder SD card by this command.

For example, when performing the 10th measurement with scene 1 after the Sensor's power supply has been turned on, and the execution time of this command is December 5, 2013, at 22:10:21
img_Scn001_2013_12_05-22_01_21(1)_0010_OK.ifz

● Save All Setting Data: 280F 00705000

This command saves all setting data (all scene data, system data, calibration group data) for the Sensor to the SD card inserted in the Touch Finder as a backup file.

The destination for backup data is the following fixed directory on the SD card.

\Sensor name\BKD

Format

MRC (1 byte)	SRC (1 byte)	Vision Sensor command code (4 bytes)	All setting data file name (4 to 64 byte)
28	0F	00705000	64 characters max.

Response Format

MRC (1 byte)	SRC (1 byte)	MRES (1 byte)	SRES (1 byte)	Vision Sensor command code (4 bytes)
28	0F	End code		00705000

End Codes

End code (hex)	Meaning
0000	Command execution ended normally.
FFFF	Command execution ended in an error.

Parameter Descriptions

All setting data file name	This command specifies the all setting data backup file name. The file name extension (.bkd) can be omitted.
----------------------------	---

Important

Do not turn off power to the Vision Sensor until there is a response.

● Save Calibration Data: 280F 0070A000

This command saves the calibration data with the specified calibration number as a file to the SD card inserted in the Touch Finder.

The destination for calibration data is the following fixed directory on the SD card.

\Sensor name\CLB

Format

MRC (1 byte)	SRC (1 byte)	Vision Sensor command code (4 bytes)	Calibration number to save (4 bytes)	Calibration data file name (4 to 64 bytes)
28	0F	0070A000	2 digits max.	64 characters max.

Response Format

MRC (1 byte)	SRC (1 byte)	MRES (1 byte)	SRES (1 byte)	Vision Sensor command code (4 bytes)
28	0F	End code		0070A000

End Codes

End code (hex)	Description
0000	Command execution ended normally.
FFFF	Command execution ended in an error.

Parameter Descriptions

Calibration number	Specifies the scene number (0 to 31) to be saved.
Calibration data file name	Specifies the file name when saving. The file name extension (.clb) can be omitted.

Important

- If the specified file name already exists, this existing file will be overwritten.
- Do not turn off power to the Vision Sensor until there is a response.

● Save All Calibration Data: 280F 0070B000

Saves all calibration data as a file to the SD card inserted in the Touch Finder.

The destination for all calibration data is the following fixed directory on the SD card.

\\Sensor name\\CGP

Format

MRC (1 byte)	SRC (1 byte)	Vision Sensor command code (4 bytes)	All calibration data file name (4 to 64 bytes)
28	0F	0070B000	64 characters max.

Response Format

MRC (1 byte)	SRC (1 byte)	MRES (1 byte)	SRES (1 byte)	Vision Sensor command code (4 bytes)
28	0F	End code		0070B000

End Codes

End code (hex)	Description
0000	Command execution ended normally.
FFFF	Command execution ended in an error.

Parameter Descriptions

All calibration data file name	Specifies the all calibration data file name to be saved. The file name extension (.cgp) can be omitted.
--------------------------------	---

Important

- If the specified file name already exists, this existing file will be overwritten.
- Do not turn off power to the Vision Sensor until there is a response.

● Save Model Dictionary Data: 280F 0070C000

Saves the specified number of model dictionary data as a file to the SD card inserted in the Touch Finder. The destination for model dictionary data is the following fixed directory on the SD card.
 \Sensor name\DIC

Format

MRC (1 byte)	SRC (1 byte)	Vision Sensor command code (4 bytes)	Model dictionary number to be saved (4 bytes)	Model dictionary data file name (4 to 64 bytes)
28	0F	0070C000	2 digits max.	64 characters max.

Response Format

MRC (1 byte)	SRC (1 byte)	MRES (1 byte)	SRES (1 byte)	Vision Sensor command code (4 bytes)
28	0F	End code		0070C000

End Codes

End code (hex)	Description
0000	Command execution ended normally.
FFFF	Command execution ended in an error.

Parameter Descriptions

Model dictionary number	Specifies the scene number (0 to 31) to be saved.
Model dictionary data file name	Specifies the file name when saving. The file name extension (.dic) can be omitted.

Important

- If the specified file name already exists, this existing file will be overwritten.
- Do not turn off power to the Vision Sensor until there is a response.

● Save All Model Dictionary Data: 280F 0070D000

Saves all model dictionary data as a file to the SD card inserted in the Touch Finder.
The destination for all model dictionary data is the following fixed directory on the SD card.
\Sensor name\DGP

Format

MRC (1 byte)	SRC (1 byte)	Vision Sensor command code (4 bytes)	All model dictionary data file name (4 to 64 bytes)
28	0F	0070D000	64 characters max.

Response Format

MRC (1 byte)	SRC (1 byte)	MRES (1 byte)	SRES (1 byte)	Vision Sensor command code (4 bytes)
28	0F	End code		0070D000

End Codes

End code (hex)	Description
0000	Command execution ended normally.
FFFF	Command execution ended in an error.

Parameter Descriptions

All model dictionary data file name	Specifies the all model dictionary data file name to be saved. The file name extension (.dgp) can be omitted.
--	--

Important

- If the specified file name already exists, this existing file will be overwritten.
- Do not turn off power to the Vision Sensor until there is a response.

● Save Latest Input Image Data: 280F 00704020

Saves the latest input image to the SD card inserted in the Touch Finder as ifz data.

The destination for image data is the following fixed directory on the SD card.

\\Sensor name\CAPTURE\Number*

* Number is a five digit number starting from 00000. The images are saved in increments of 100 images for each number, and when there are over 100 images, the directory with the next number is created.

Format

MRC (1 byte)	SRC (1 byte)	Vision Sensor command code (4 bytes)	Image data file name (4 to 64 bytes)
28	0F	00704020	64 characters max.

Response Format

MRC (1 byte)	SRC (1 byte)	MRES (1 byte)	SRES (1 byte)	Vision Sensor command code (4 bytes)
28	0F	End code		00704020

End Codes

End code (hex)	Description
0000	Command execution ended normally.
FFFF	Command execution ended in an error.

Parameter Descriptions

Image data file name	Specifies the image data file name to save. The file name extension (.ifz) can be omitted.
----------------------	---

Important

- If the specified file name already exists, this existing file will be overwritten.
- Do not turn off power to the Vision Sensor until there is a response.

● Save Measurement Data: 280F 00707000

Saves measurement data saved in the Sensor's memory by the logging function to the SD card inserted in the Touch Finder as csv data.

The destination for measurement data is the following fixed directory on the SD card.

\Sensor name\LOGDATA

The file name is automatically created as follows.

YYYY_MM_DD-HH_mm_ss.csv

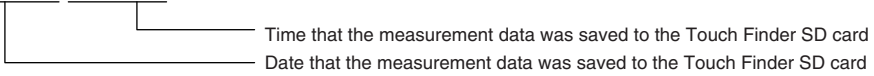

The date and time that make up the measurement data file name are not the date and time that the measurement was performed, they are the date and time the measurement data file was saved from the Sensor to the Touch Finder SD card by this command.

Format

MRC (1 byte)	SRC (1 byte)	Vision Sensor command code (4 bytes)
28	0F	00707000

Response Format

MRC (1 byte)	SRC (1 byte)	MRES (1 byte)	SRES (1 byte)	Vision Sensor command code (4 bytes)
28	0F	End code		00707000

End Codes

End code (hex)	Description
0000	Command execution ended normally.
FFFF	Command execution ended in an error.

Important

Do not turn off power to the Vision Sensor until there is a response.

● Save Statistical Data: 280F 00708000

Saves statistical data saved in the Sensor's memory by the logging function to the SD card inserted in the Touch Finder as csv data.

The destination for statistical data is the following fixed directory on the SD card.

\Sensor name\LOGDATA

The file name is automatically created as follows.

YYYY_MM_DD-HH_mm_record.csv

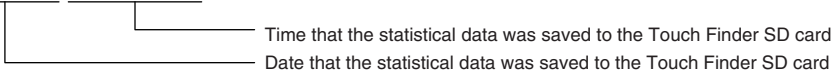

The date and time that make up the statistical data file name are not the date and time that the measurement was performed, they are the date and time the statistical data file was saved from the Sensor to the Touch Finder SD card by this command.

Format

MRC (1 byte)	SRC (1 byte)	Vision Sensor command code (4 bytes)
28	0F	00708000

Response Format

MRC (1 byte)	SRC (1 byte)	MRES (1 byte)	SRES (1 byte)	Vision Sensor command code (4 bytes)
28	0F	End code		00708000

End Codes

End code (hex)	Description
0000	Command execution ended normally.
FFFF	Command execution ended in an error.

Important

Do not turn off power to the Vision Sensor until there is a response.

5-2 Detailed EtherNet/IP Communications Specifications

FQ2-S1

FQ2-S2

FQ2-S3

FQ2-S4

FQ2-CH

This section lists the objects that are mounted in the Sensor.

1-1 01h Identity Object

Class Attributes

ID	Access	Name	Data type	Description	Attribute value
1	Get	Revision	UINT	Revision of the object	1
2	Get	Max Instance	UINT	Maximum instance number	1
3	Get	Number of Instances	UINT	Number of object instances	1
4	Get	Revision	Structure	Revision of Identity object	1.1
		Major Revision	UINT	Major revision	1
		Minor Revision	UINT	Minor revision	1
7	Get	Maximum ID Number Instance Attributes	UINT	Attribute ID of instance attributes	7

Instance Attributes

ID	Access	Name	Data type	Description	Attribute value
1	Get	Vendor ID	UINT	Vendor ID	47
2	Get	Device Type	UINT	General device type	43
3	Get	Product Code	UINT	Product code	1645
4	Get	Revision	Structure	Revision of Identity object	1.1
		Major Revision	UINT	Major revision	1
		Minor Revision	UINT	Minor revision	1
5	Get	Status	WORD	Current status of device	
6	Get	Serial Number	UDINT	Serial number	Lower 4 bytes of MAC address
7	Get	Product Name	SHORT-STRING	Product name	"FQ Series"

Services

Code	Service name	Class	Instances	Remarks
01 hex	Get_Attribute_All	Yes	Yes	
05 hex	Reset	No	Yes	Parameter: 0, 1
0E hex	Get_Attribute_Single	Yes	Yes	

1-2 02h Message Router Object

Class Attributes

None

Instance Attributes

None

Services

None

1-3 06h Connection Manager

Class Attributes

None

Instance Attributes

None

Services

Code	Service name	Class	Instances	Remarks
54 hex	Forward Open	No	Yes	
4E hex	Forward Close	No	Yes	

1-4 F5h TCP/IP Interface

Class Attributes

ID	Access	Name	Data type	Description	Attribute value
1	Get	Revision	UINT	Revision of the object	1
2	Get	Max Instance	UINT	Maximum instance number	1
3	Get	Num Instance	UINT	Number of object instances	1

Instance Attributes

ID	Access	Name	Data type	Description	Attribute value
1	Get	Status	DWORD	Interface status	0x0002 (Depends on the device.)
2	Get	Configuration Capability	DWORD	Interface Function Flag	0x0002 (Depends on the device.)
3	Get/Set	Configuration Control	DWORD	Interface Control Flag	0x0000

ID	Access	Name	Data type	Description	Attribute value
4	Get	Physical Link Object	STRUCT of:	Path to the link object in the physical layer	---
		Path size	UINT	Path size	2
		Path	Padded EPATH	Segment to identify physical-layer linked object	20 F6 24 01
5	Get	Interface Configuration	STRUCT of:	TCP/IP network interface settings	
		IP Address	UDINT	IP address of the device	
		Network Mask	UDINT	Network mask of the device	
		Gateway Address	UDINT	Default gateway address	
		Name Server	UDINT	Primary name server	
		Name Server 2	UDINT	Secondary name server	
6	Get	Host Name	STRING	Host name	

Services

Code	Service name	Class	Instances	Remarks
01 hex	Get_Attribute_All	No	Yes	
02 hex	Set_Attribute_All	No	Yes	
0E hex	Get_Attribute_Single	No	Yes	
10 hex	Set_Attribute_Single	No	Yes	

1-5 F6h Ethernet Link

Class Attributes

ID	Access	Name	Data type	Description	Attribute value
1	Get	Revision	UINT	Revision of the object	1
2	Get	Max Instance	UINT	Maximum instance number	1
3	Get	Num Instance	UINT	Number of ports for which instances are created	1

Instance Attributes

ID	Access	Name	Data type	Description	Attribute value
1	Get	Interface Speed	UDINT	Interface baud rate	
2	Get	Interface Flags	DWORD	Interface Status Flag	
3	Get	Physical Address	ARRAY of 6 USINTs	MAC-layer address	

Services

Code	Service name	Class	Instances	Remarks
01 hex	Get_Attribute_All	No	Yes	
0E hex	Get_Attribute_Single	Yes	Yes	

1-6 04h Assembly Object

Class Attributes

ID	Access	Name	Data type	Description	Attribute value
1	Get	Revision	UINT	Revision of the object	2

Instance Attributes (O to T), Instance ID: 100

ID	Access	Name	Data type	Description	Attribute value
3	Get/Set	Data	BYTE array	Byte data (Data format is defined by application.)	 Memory Assignments: p. 102
4	Get	Size	UINT	Number of bytes	O to T data size (Set before going online.)

Instance Attributes (T to O), Instance ID: 101

ID	Access	Name	Data type	Description	Attribute value
3	Get	Data	BYTE array	Byte data (Data format is defined by application.)	 Memory Assignments: p. 102
4	Get	Size	UINT	Number of bytes	O to T data size (Set before going online.)

Services

Code	Service name	Class	Instances	Remarks
0E hex	Get_Attribute_Single	Yes	Yes	
10 hex	Set_Attribute_Single	No	Yes	

1-7 64h Vision Sensor Object

Instance Attributes

ID	Access	Name	Data type	Description	Attribute value
1	Set	Data	BYTE array	Set command strings to be sent to the sensor controller. (504 characters max.) The available commands are equivalent to the commands which can be used for the no-protocol communications.	 Command List: p. 202

Services

Code	Service name	Class	Instances	Remarks
0x32	SetAttribute	No	Yes	

Index

Numerics			
0 Suppressed		173	
A			
ACK signal ON period		74	
B			
baud rate		197	
binary data file load and save commands		183	
BUSY signal		34	
BUSY signal output polarity		44	
C			
character output		22	
clearing measurement values		52	
command (command area)		123	
command list		202	
command list (EtherNet/IP)		109	
command list (No-protocol (TCP), No-protocol (UDP))		177	
command list (parallel connection)	46, 75		
command list (PLC link)		132	
command list (PROFINET)		156	
command/response method		20	
communication protocols for communication with the Sensor		12	
connection compatibility		14	
connection mode		124	
control signals and status signals		18	
D			
data length		197	
data output after measurements		21	
data output period	94, 124, 147		
decimal output form		173	
delimiter		197	
detailed EtherNet/IP communications specifications		433	
digits of decimal		173	
digits of integer		173	
E			
ERROR signal		51	
errors			
clearing		46	
Ethernet no-protocol commands		176	
EtherNet/IP		88	
expanded mode		45	
expression judgements		41	
external trigger		36	
F			
field separator		173	
FINS commands		190	
FINS/TCP no-protocol commands		188	
flow control		197	
G			
GATE ON delay		66	
	GATE signal ON period		94, 124, 147
H			
handshaking		30, 70	
I			
individual judgements		41	
input port No.		168, 190	
interval timeout		198	
L			
Lighting control		75	
line delimiter		175	
M			
max output data		124	
measurement data		22	
measurements			
continuous		37, 46	
models that are compatible with the communications protocols		15	
N			
negative		45, 74, 173	
NG string output on/off		101, 151, 175	
no-protocol (TCP)		167	
no-protocol (UDP)		167	
no-protocol command		198	
number of delay		66	
O			
One-shot output		43	
OR output		44	
OR signal		34	
OUT0 to OUT3 output polarity		45	
OUT1 Polarity		44	
output (output area)		123	
output control		66	
output data size		93, 146	
Output delay		43	
output form		100, 151	
output handshake		93, 123, 146	
output IP address		168, 190	
Output mode		44	
output period		66	
output polarity		74	
output port No.		168	
output string setup		101, 151, 175	
Output time		43	
output time		66	
overall judgement		40	
P			
parallel connection		34	
parallel data output		63	
Parallel Interface Sensor Data Unit		60	
parallel judgement outputs		62	
parameter notation examples for command control		200	
parity		197	
partial output ON/OFF		101, 151, 175	

port No.	190
positive	45, 74
PROFINET	140
<hr/>	
R	
record separator	173
reference color	
re-registering	46
refreshing task period	94, 146
response (response area)	123
retry details	123
retry interval	124
RS-232C connections	196
RS-232C no-protocol commands	198
RS-232C no-protocol communications	197
<hr/>	
S	
scenes	
switching	46
setting data communications specifications	
Parallel Sensor Data Unit	66
setting the data to output automatically after	
measurements	198, 207
EtherNet/IP	97, 148
no-protocol (RS-232C)	198, 207
no-protocol (TCP)	167, 190
PLC Link	124
setting up communications specifications	
EtherNet/IP	92, 145
no-protocol (RS-232C)	197
no-protocol (TCP)	167, 189
PLC Link	122
setting up no-protocol communications	197
standard mode	45
stop bit	197
string output ON/OFF	101, 151, 175
system configuration	8
<hr/>	
T	
tag data link	95
timeout	66, 94, 146
total timeout	198
trigger retry	52, 85

Revision History

A manual revision code appears as a suffix to the catalog number at the bottom of the front and back covers of this manual.

Cat. No. Z338-E1-02

↑
Revision code

Revision code	Date	Revised contents
01	December 2013	Original production
02	July 2014	Corrected minor mistakes.

OMRON Corporation Industrial Automation Company

Tokyo, JAPAN

Contact: www.ia.omron.com

Regional Headquarters

OMRON EUROPE B.V.

Sensor Business Unit

Carl-Benz-Str. 4, D-71154 Nufringen, Germany
Tel: (49) 7032-811-0/Fax: (49) 7032-811-199

OMRON ELECTRONICS LLC

One Commerce Drive Schaumburg,
IL 60173-5302 U.S.A.
Tel: (1) 847-843-7900/Fax: (1) 847-843-7787

OMRON ASIA PACIFIC PTE. LTD.

No. 438A Alexandra Road # 05-05/08 (Lobby 2),
Alexandra Technopark,
Singapore 119967
Tel: (65) 6835-3011/Fax: (65) 6835-2711

OMRON (CHINA) CO., LTD.

Room 2211, Bank of China Tower,
200 Yin Cheng Zhong Road,
PuDong New Area, Shanghai, 200120, China
Tel: (86) 21-5037-2222/Fax: (86) 21-5037-2200

Authorized Distributor:

© OMRON Corporation 2013 All Rights Reserved.
In the interest of product improvement,
specifications are subject to change without notice.

Cat. No. Z338-E1-02

Printed in Japan
0714