

OMRON

Uninterruptible Power Supply (UPS/200-240V model)

BU2002RWLG/BU3002RWLG/BU5002RWLG

User's Manual

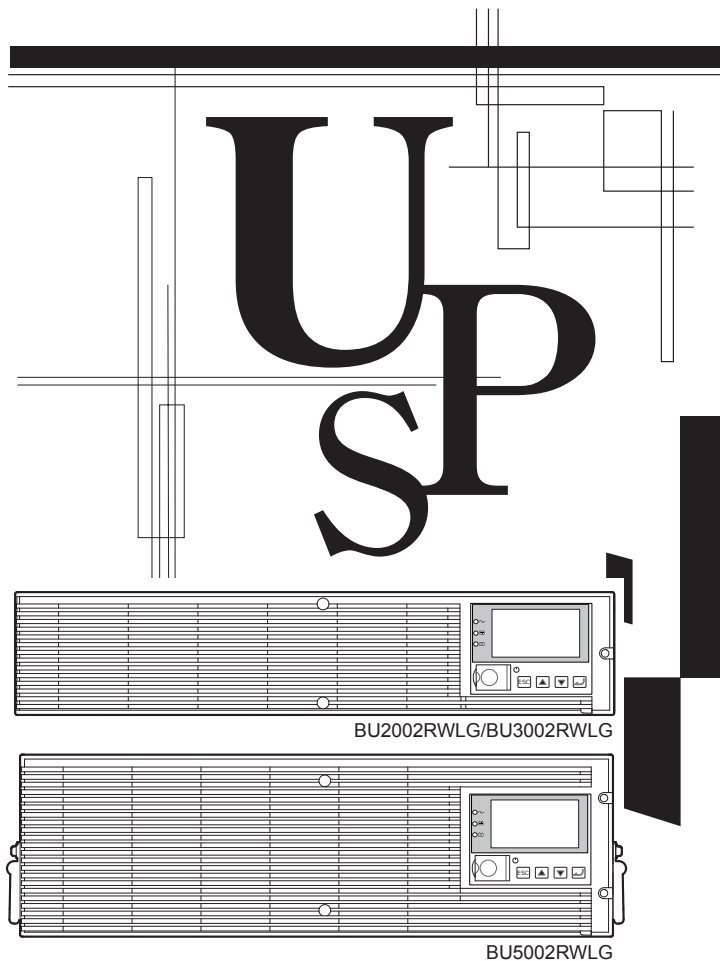

- This manual provides important safety-related information. Thoroughly read and understand this manual before installing and using the product.
- Keep this manual in a convenient location so that you can refer to it whenever necessary.
- The contents of this manual are subject to change without notice.

Introduction

Features of this product

Thank you for purchasing Omron's Uninterruptible Power Supply (UPS).

- The UPS protects computers and other devices from power failures, voltage variations, instantaneous voltage drops, and surge voltage such as that caused by lightning (a phenomenon in which extraordinary high voltage occurs instantaneously).
- Under normal conditions, a stable sine wave AC voltage is output by raising the voltage (when the input voltage is low) or lowering the voltage (when the input voltage is high) according to the input voltage status, in synchronization with commercial power input. In addition, a full-time inverter supply method (high efficiency) is employed; when abnormalities in commercial power are detected, such as in a power failure or when there are large changes in voltage, power supply is uninterruptedly shifted to the battery, and sine wave output is continued.
- Output capacity is 2000VA/1400W for BU2002RWLG, 3000VA/2100W for BU3002RWLG and 5000VA/3500W for BU5002RWLG.

Notes on the use of the Backup Power Supply

- This product is designed and manufactured for use with FA or OA equipment such as personal computers.
Do not use it when very high reliability and safety are required as listed below.
 - Medical equipment that may cause death directly
 - Applications that may cause injury (applications that directly affect the operation and control of planes, ships, railroads, and so on)
 - Applications that are always subjected to vibration such as cars and ships
 - Applications in which a failure of this product may cause significant damage or effect to the society and public (important computer systems, main communication equipment, public transportation systems, and so on)
 - Equipment with the same level of importance
- For equipment that greatly affects the safety of people and maintaining public functions, special considerations related to operation, maintenance, and management must be taken such as duplicating the system and emergency power generation facilities.
- Observe the contents of this manual such as the use conditions and environments.
- When you want to use this product for an important system that requires very high reliability, contact Omron representatives.
- Do not modify/alter this product.

Disclaimers

We are not liable for any damage or secondary damage resulting from the use of our product, including malfunction and failure of equipment, connected devices, or software.

- Make sure to read the safety precautions before using the unit.
- In the event you transfer or sell this unit to a third party, please include all of the documentation that came with this unit. This is to ensure that the unit is used in line with the conditions described in the included documentation.
 - This manual contains important safety-related information. Please read and understand the contents of the manual before beginning operation.
If you discover any omissions or errors in the manual, please contact the shop of purchase.

- Windows is the registered trademark of Microsoft Corporation in the United States and/or other countries.
- The names of other companies and products mentioned herein are the trademarks or registered trademarks of their respective owners.

IMPORTANT SAFETY INSTRUCTION

1. SAVE THESE INSTRUCTIONS.

This manual contains important instructions for BU2002RWLG/BU3002RWLG/BU5002RWLG that should be followed when using the UPS and batteries.

2. SYMBOL

 This symbol indicates earth ground.

 This symbol indicates turning on UPS.

 This symbol indicates turning off UPS.

3. INTERNAL BATTERY

Internal battery voltage is 48VDC for BU2002RWLG and 72VDC for BU3002RWLG/BU5002RWLG.

4. TEMPERATURE RATING

The maximum ambient temperature of the UPS is 40°C.

5. ENVIRONMENT

The unit is intended for installation in a temperature controlled, indoor area free of conductive contaminants.

Procedure from installation to operation

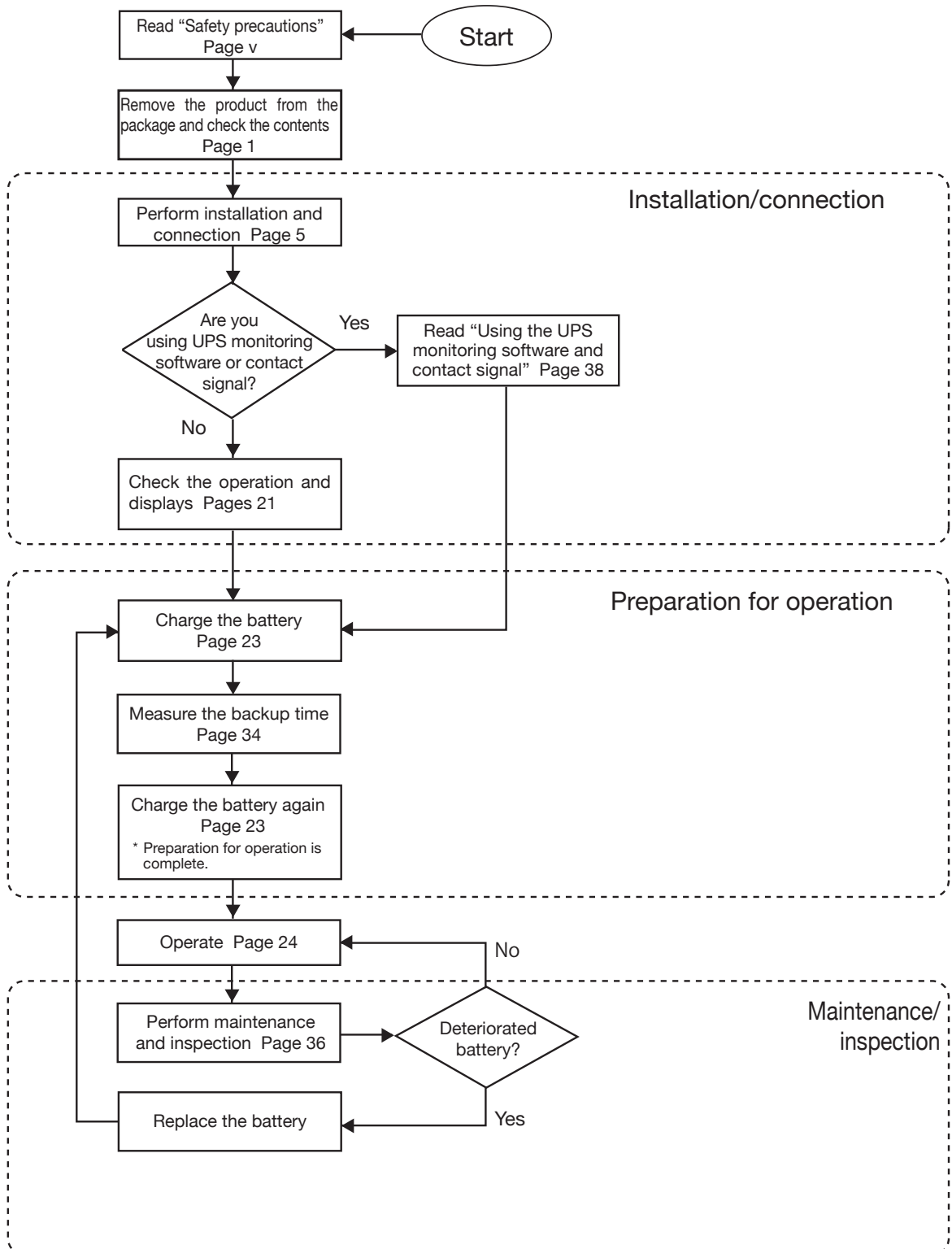



TABLE OF CONTENTS

- Introduction i
- IMPORTANT SAFETY INSTRUCTION ii
- Safety precautions v
- 1. Preparation..... 1
 - 1-1 Unpacking the product1
 - 1-2 Name of each part2
 - 1-3 Explanation of symbols used on unit4
- 2. Installation and connection..... 5
 - 2-1 Precautions and notes on installation and connection 5
 - 2-2 Installation9
 - 2-3 Connecting the equipment14
 - 2-4 Connecting the AC input.....18
 - 2-5 Checking the operation21
 - 2-6 Charging the battery23
 - 2-7 Measuring the initial value of backup time23
 - 2-8 Recharging the battery23
- 3. Operation 24
 - 3-1 Precautions and notes for operation24
 - 3-2 Start and stop procedures and basic operation.....26
 - 3-3 Interpreting beeps and displays29
- 4. UPS functions 30
 - 4-1 Suspending a beep.....30
 - 4-2 Self-diagnosis test.....30
 - 4-3 Battery life counter function31
 - 4-4 Operation panel setting31
- 5. Measuring the backup time 34
 - 5-1 How to measure backup time.....34
 - 5-2 Estimated backup time34
- 6. Maintenance and Inspection 36
 - 6-1 Checking the battery.....36
 - 6-2 Cleaning.....37
- 7. Using the UPS monitoring software and contact signal 38
 - 7-1 When using the included UPS monitoring software to perform auto shutdown40
 - 7-2 Contact signal42
- 8. Troubleshooting 45
- References 46
 - A. Specifications.....46
 - B. Dimensions47
 - C. Circuit block diagram51
 - D. Related products51

Safety precautions

Important information for safe operation is described. Be sure to read it before installation and start of use.

- The safety symbols and their meaning used in this manual are as follows:

 Warning	Misuse may cause death or serious injury.
 Caution	Misuse may cause injury or property damage.

* Property damage means damage to houses/household effects, livestock, and pets.

-  : Indicates prohibition. For example,  indicates that disassembly is prohibited.
-  : Indicates obligation. For example,  indicates that grounding is necessary.

Note that events categorized as a caution required matter also may cause more serious results under certain conditions.

Warning

Do not use this unit when very high reliability and safety are required as listed below. This unit is designed and manufactured for use with FA or OA equipment such as personal computers. 

- Medical equipment or system that may cause death directly.
- Applications that directly affect the safety of people (For example, the operation and control of cars).
- Applications in which a failure of the unit may cause significant damage to the society and public (For example, essential computer systems and main communication equipment.)
- Applications with the same level of importance.

Caution (for installation and connection)

Carry the unit considering its weight and balance, and place it on a stable and robust base. 

- Dropping or toppling the unit may cause injury.
- The approximate weights of the units are 28kg (BU2002RWLG), 33kg (BU3002RWLG) and 61kg (BU5002RWLG).
- If you drop the unit, stop using it and have it inspected and repaired. For repair, contact Omron representatives.

Do not hold the side of the front panel when lifting. 

- Injury may result if the panel comes off and falls.

Keep plastic package bags out of reach of children. 

- Children may suffocate if they place their heads into plastic bags.

Make sure to connect the unit's AC input plug to a commercial power source with rated input voltage (200/208/220/230/240VAC) and 50/60 Hz frequency. 

- Connecting to a commercial power source with a different rated input voltage or frequency may result in a fire.
- The unit may fail.

 **Caution (for installation and connection)**

For BU5002RWLG, when an abnormality (unusual sound or smell) occurs, disconnect the AC input plug from the wall outlet, or turn OFF the INPUT PROTECTION switch (input overcurrent protection switch) on the back of the unit. The socket-outlet shall be installed near the equipment and shall be easily accessible.



For BU2002RWLG and BU3002RWLG, turn OFF the external breaker installed on the input side.

- When performing maintenance on the connected devices, follow the above instructions to ensure safety.

Do not connect devices such as dryers, some solenoid valves, etc., which have a half-wave rectifier that allows only half-cycle AC power to flow through.



- Overcurrent may damage the UPS.

Connect the unit to a wall outlet (commercial power) with the appropriate capacity (11A or greater for BU2002RWLG, 16A or greater for BU3002RWLG and 27A or greater for BU5002RWLG).



- Otherwise, the power cord may be heated.
- When equipment with the maximum output capacity is connected, a maximum current of 11A (BU2002RWLG), 16A (BU3002RWLG), or 27A (BU5002RWLG) flows.

When changing the input cable, make sure to perform the connection as specified.



- When connecting a cable to the terminal block, use a cable that complies with the input current specification of the UPS.
- Failure to do so may result in electric shock or ground fault.

When in use, make sure the output terminal block cover is attached. Do not turn ON the power switch when it is detached.



- Voltage is applied to the output terminal block when the power switch is ON, which can result in electric shock.

Provide secure grounding.



- For AC input plug connection, connect the plug directly to a commercial power source. For terminal block connection, connect the cable to a commercial power source and ground it. A failure or leak that occurs when the unit is not properly grounded may result in electric shock.

Do not disassemble, repair, or modify the unit.



- Doing so may cause an electric shock or a fire.

Do not install the unit in other than specified orientations.



- Dropping or toppling the unit may cause injury.
- If you install the unit in an orientation other than specified, the unit cannot be protected from a battery fluid leakage.
- Use the included vertical stand when positioning the unit vertically.

Do not use the unit where the maximum temperature exceeds 40°C.



- The battery deteriorates rapidly.
- Doing so may cause a failure or malfunction of the unit.

⚠ Caution (for installation and connection)

Do not exceed the ranges specified for environmental conditions during use/storage.



Do not install or store the unit in the places listed below.

- Do not store in places where the humidity is lower than 10% or higher than 90%.
- Do not use the unit in places where the ambient temperature is lower than 0°C or higher than 40°C. (With no condensation)
- Do not use in places where the humidity is lower than 10% or higher than 90%.
- Do not install/store the unit in closed places such as cabinets with no clearance, places where there is flammable or corrosive gas, places with large amounts of dust, places exposed to direct sunlight, places exposed to shock or vibration, salty or wet places, or outdoors.
- Installation or storing the unit in such a place may cause a fire.

Do not connect equipment that exceeds the output capacity of the unit. You can use plug strip to connect additional devices, but do not connect devices that exceed the current capacity of the plug strip.



- The current protection of the unit may operate, which may stop the output.
- The wiring of the plug strip heats up, which may cause a fire.

Do not pinch or sharply bend the cable.



Do not fold or knot the cable.

- Doing so may cause the cable to be damaged or heated, which may cause an electric shock or a fire.
- If the cable is damaged, stop using the unit and have the cable repaired.
- For repair, contact Omron representatives.

All of the included accessories are designed to be used exclusively with the unit. Do not use the accessories with other devices.



- Doing so may compromise the safety of devices.

Do not block the air vents (front and rear).



- Doing so will cause the internal temperature to rise, which may cause the unit to fail and the battery to deteriorate.
- Leave at least 5 cm of space between the front vent and the wall, and at least 10 cm of space between the rear vent and the wall.

Do not connect devices that cannot be used with commercial power supply.



- When the unit's power switch is turned ON and an error occurs with the connected device, bypass operation is performed and commercial power supply is supplied as is to the connected devices.

When installing the unit on a rack, place it on the lower shelf.



- Injury may result if the unit falls.

Make sure to use the mounting screws included with the brackets.



- Mounting screws other than those included may not be strong enough to support the unit, causing it to fall.
- If you attach the case using long screws other than those included with the product, you may damage the internal parts of the unit.

When using the unit in the 100V output mode, check that the output voltage is set to 100V, and then turn ON the power switch.



- Connecting a 100V device to the unit while outputting in the 200V mode may cause a failure of the device or a fire.
- The output voltage can be set with "Settings" - "In/Out Settings" - "Output Voltage" in the menu on the LCD.

⚠ Caution (for use)

Do not allow the unit to come in contact with water.



If you drop the unit, stop using it.

- Doing so may cause an electric shock or a fire.
- If the unit becomes wet or is dropped, immediately stop using it, disconnect the AC input cable from commercial power and have the unit inspected and repaired.
- For repair, contact Omron representatives.

When the battery is dead, replace it immediately or stop using the unit.



- Continuing the use of it may cause fire or electric shock due to liquid leaks.

Ambient temperature	Expected life
25°C	5 years
35°C	2.5 years

* The values in the table are the expected life under standard use conditions and are not guaranteed.

Using a dry cloth, periodically wipe the dust from the AC input plug, input terminal block and power supply output receptacles.



- Accumulated dust may cause a fire.

Do not use the unit in a closed place and do not cover the unit.



- Doing so may cause abnormal heating or a fire.
- Depending on the operating environment, hydrogen gas may be generated from the battery, resulting in a rupture or explosion. Ventilate the area around the unit.

If you notice an abnormal sound or smell, smoke, or leaking fluid, immediately turn OFF the unit's power switch and stop the supply of commercial power.



- Using the unit under such conditions may cause a fire.
- If you notice such a condition, stop using the unit and contact Omron representatives. for inspection and repairs.
- Position the unit in such a way that you can immediately disconnect the AC input plug from the wall outlet (commercial power) in the event a problem occurs.

If fluid leaks from the unit, do not touch the fluid.



- Doing so may cause blindness or burns.
- If the fluid contacts your eyes or skin, wash it out with lots of clean water and consult your doctor.

Do not place objects heavier than 25 kg on the unit, and do not drop heavy objects onto the unit.



- Doing so may cause distortion/damage to the case or a failure of the internal circuit, which may cause a fire.

The unit is equipped with a bypass circuit which is able to supply electric power to connected devices even when the inner control circuit is broken down by defects or malfunctions



- Output is continuing even when all indicators of the front panel are off.
- If you want to stop the output, either stop the source of commercial power or disconnect the AC input plug from the wall outlet (commercial power).

Do not sit or stand on top of the product, use it as a step ladder, or lean against it.



- Doing so may cause the unit to fail or to fall over and result in injury.

Caution (for maintenance)

When maintaining the connected equipment, turn OFF the unit's power switch to stop the output, and stop the supply of commercial power. 

- Even if commercial power to the UPS is stopped while it is in operation, the power output of this unit does not stop and power is supplied from the receptacle.

Do not disassemble, repair, or modify the unit. 

- Doing so may cause an electric shock or a fire.

If fluid leaks from the unit, do not touch the fluid. 

- Doing so may cause blindness or burns.
- If the fluid contacts your eyes or skin, wash it out with lots of clean water and consult your doctor.

Do not throw the unit into fire. 

- The lead battery in the unit may explode, or leak dilute sulfuric acid.

Do not insert metal objects into the power supply output receptacle of the UPS. 

- Doing so may result in electric shock.

Do not insert metal objects into the battery connectors. 

Do not create a short between the connector terminals.

- Doing so may result in electric shock.

Caution (for battery replacement)

Perform replacement on a stable and flat place. 

- Handle the battery carefully so that you do not drop it.
- Not doing so could cause injury or burns due to liquid (acid) leakage.

Use a specified battery for replacement. 

- Not doing so may cause a fire.
- Replacement battery pack for
BU2002RWLG: BUB2002RW
BU3002RWLG: BUB3002RW
BU5002RWLG: BUB3002RW (2PCS.)

Do not replace the battery in a place where there is flammable gas. 

- Spark may occur when connecting the battery, which may cause an explosion or fire.

If fluid (dilute sulfuric acid) leaks from the battery, do not touch the fluid. 

- Doing so may cause blindness or burns.
- If it contacts your eyes or skin, wash it out with lots of clean water and consult your doctor.

Do not disassemble or modify the battery. 

- Doing so could cause dilute sulfuric acid leak, which could cause blindness and burns.

Do not drop the battery and do not expose it to strong impact. 

- Dilute sulfuric acid may leak.

Do not short the battery with metal objects. 

- Doing so could cause an electric shock, fire or burn.
- Some electrical energy still remains inside the spent battery.

Do not put the battery into fire and do not break it. 

- The battery may explode or leak dilute sulfuric acid.

Do not use a new battery and an old battery at the same time. 

- Dilute sulfuric acid may leak.

Notes

When moving the unit from a cold place to a warm place, leave it for several hours before using it.

- If the unit is promptly turned ON after being moved to a warmer place, condensation may form inside the unit and cause it to fail.

Charge the battery soon after purchasing the unit.

- If you do not use the unit for a long time after the purchase, the battery may deteriorate and the battery may become unusable.
- The battery can be charged once the AC input plug is connected to commercial power.

Recharge the battery for at least 8 hours every 6 months when the storage temperature is 25°C or less, or every 2 months when the storage temperature is 40°C or less.

- The battery self-discharges even when it not being used, and it goes into over-discharge state if it is left for a long period of time. The backup time may become shorter or the battery may become unusable.
- We recommend keeping the temperature 25°C or less when storing the unit for long periods of time.
- Turn OFF the unit's power switch when storing it.

Do not short the output lines of the unit to each other, and do not short the output lines to the ground.

- The unit may fail.

Do not connect the AC input terminal of the unit to its Power Supply Output terminal during the Battery Mode.

- The unit may fail.

Do not connect a page printer (such as a laser printer) to the unit.

- The unit repeatedly and frequently switches between Commercial Power Mode and Battery Mode, which may shorten the life of the battery.
- The page printer has a large peak current, so an excess of the connection capacity or a power failure due to instantaneous voltage drop may be detected.

Do not install or store the unit in a place exposed to direct sunlight.

- The rise of temperature may cause the built-in battery to deteriorate rapidly and become unusable.

Do not perform withstand voltage tests.

- Performing withstand voltage tests may damage the surge absorption element built into the power supply input circuit.
- When performing an insulation resistance test, use the 400 VDC range.

Before stopping the commercial power to the unit, turn OFF the power switch of the unit.

- The unit enters Battery Mode when commercial power is stopped. If you frequently use the unit in Battery Mode, the battery life may be significantly shortened.

If this unit is used for an inductive device such as a coil or motor, check the operation beforehand.

- With some types of devices, the effect of inrush current may cause this unit to stop operating properly.

Notes

Check system operation beforehand if the unit is used in combination with a device whose power supply voltage and frequency fluctuate widely, such as a generator.

- If the generator's output voltage/frequency falls out of the input voltage/frequency range, the unit will enter Battery Mode.
- Even if the input frequency is within the range, the unit will enter Battery Mode when a rapid change (5 Hz/sec or greater) occurs.

In the event you transfer or sell this unit to a third party, please include all of the documentation that came with the unit. This is to ensure that the unit is used in line with the conditions described in the included documentation.

- This manual contains important safety-related information. Please read and understand the contents of the manual before beginning operation.

This unit uses lead acid batteries,

- Which are a valuable recyclable resource. Please recycle.



Take measures for handling unforeseen accidents, such as data backup and system redundancy.

- The output may stop when there is a circuit failure in the UPS.

Explanation

Usual operation

- You may either leave the power switch of the unit ON (operation status) or turn it OFF each time when stopping the connected system. Choose whichever operation method is more convenient. We recommend turning OFF the power switch when you do not use connected devices for a long time.
- The battery can be charged once the unit is connected to a commercial power source.

Quitting Battery Mode

- If a power failure lasts for an extended period of time, the battery discharges completely and power output from the unit stops. Shut down your computer after performing appropriate procedures (for example, saving data) while the unit is still supplying power.

Rebooting

- If the battery discharges completely during a power failure, the output stops. After recovery from the power failure, the unit automatically restarts and output begins. If you do not want to restart the connected devices, disable the "Settings" - "Boot Settings" - "Auto reboot" setting in the menu on the unit's LCD, or turn OFF the power switch of the connected devices.

Scheduled operation using the UPS monitoring software

- When performing scheduled operation in which the UPS is stopped and a device such as a breaker is used to stop the UPS at the same time that commercial power stops, specify a period of no more than 3 months for the start of the next operation.

If you specify a period longer than 3 months, the internal timer is reset and the scheduled operation does not start. Note that this period reduces to approximately half when the battery needs to be replaced. If a period of 3 months is exceeded, you start operation by supplying commercial power and pressing the start switch. However, if the battery needs to be replaced, you may not be able to start operation.

In this case, replace the battery.

1

Preparation

1-1

Unpacking the product



Caution

The approximate masses of the units are 28kg (BU2002RWLG), 33kg (BU3002RWLG) and 61kg (BU5002RWLG) . Since the unit is heavy, be careful not to hurt yourself when lifting or transporting it.



Hold the handle of the inner packaging when taking out the product from the package box.

- Hold the handle of the inner packaging when taking out the product from the package box.
- Dropping may cause injury.

Open the package box and take out the UPS and accessories.

1-2 Name of each part

This section describes the name of each part of the UPS.

For information on the function of each part, refer to "2. Installation and connection" on page 5 and "3. Operation" on page 24 that provides the details.

Front view

< BU2002RWLG/BU3002RWLG >

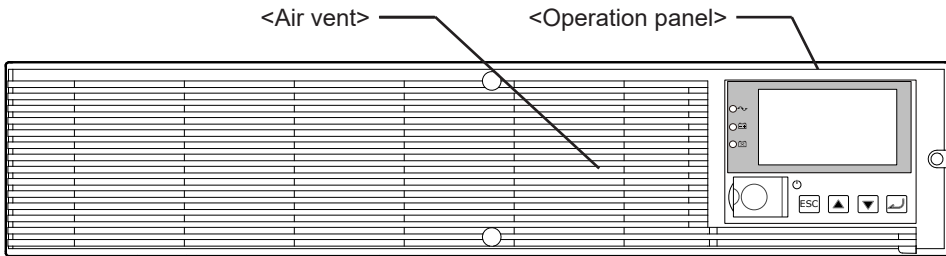

< BU5002RWLG >

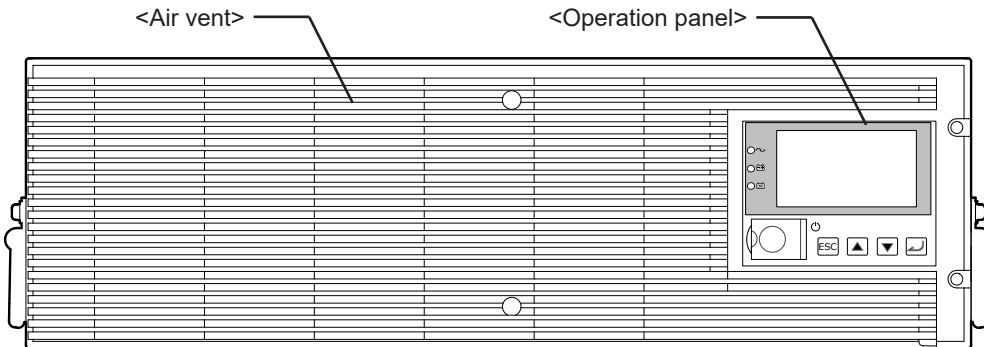

< Enlarged view of the operation panel >

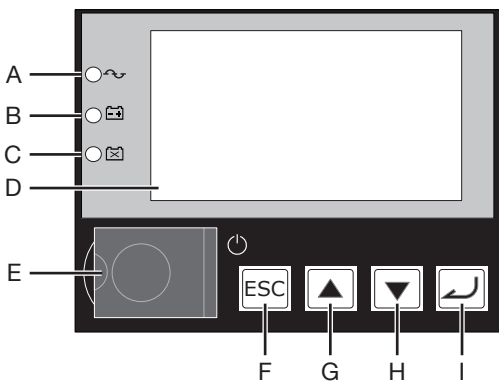

- A. Power supply output lamp
- B. Battery mode lamp
- C. Battery replacement lamp
- D. LCD for status and setting display
- E. Power switch
- F. ESC switch
- G. Up switch
- H. Down switch
- I. Enter switch

1.Preparation

Rear view

< BU2002RWLG >

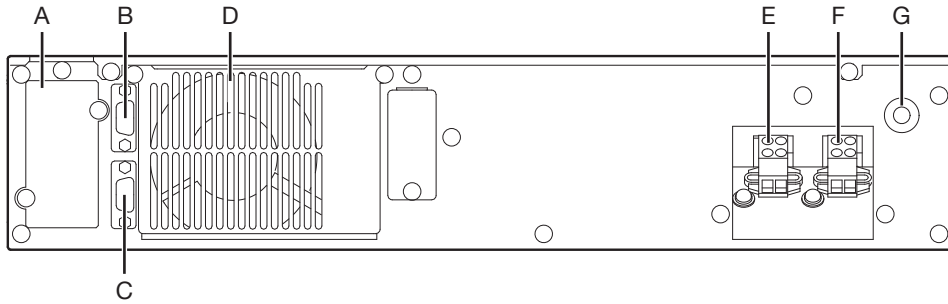

< BU3002RWLG >

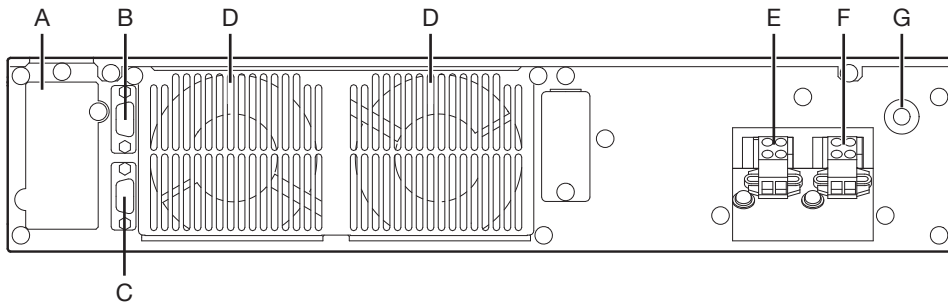

< BU5002RWLG >

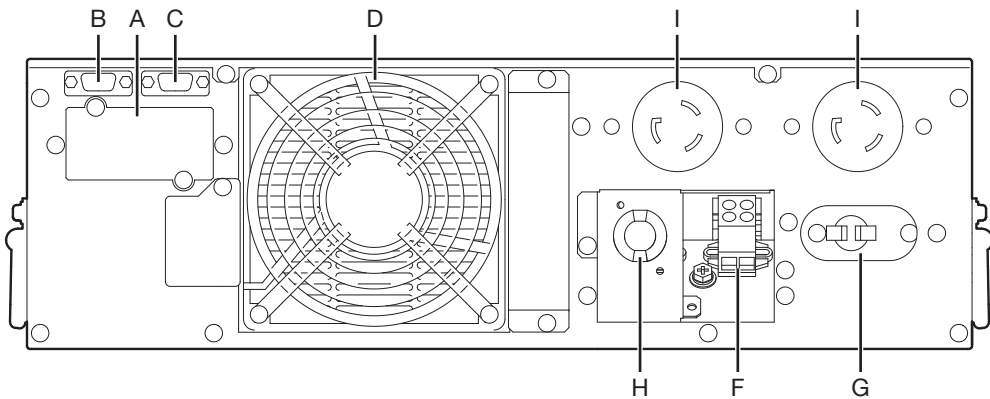







A. Option slot
B. Contact signal port
C. RS-232C port
D. Cooling fan
E. AC input terminal block

F. AC output terminal block
G. AC input overcurrent protection switch
H. AC input cable
I. AC output receptacle

1-3

Explanation of symbols used on unit

Symbol	Description
	Start the UPS.
	Stop the UPS.
	Suspend a beep.
	UPS output power enabled, supplied by operating on line mode, battery mode.
	Bypass output "ON".
	UPS output power enabled, supplied by operating on battery mode.
	Batteries at end of useful life, necessary to replace the batteries.

2

Installation and connection

2-1

Precautions and notes on installation and connection

Caution (for installation and connection)

Carry the unit considering its weight and balance, and place it on a stable and robust base. 

- Dropping or toppling the unit may cause injury.
- The approximate weights of the units are 28kg (BU2002RWLG), 33kg (BU3002RWLG) and 61kg (BU5002RWLG).
- If you drop the unit, stop using it and have it inspected and repaired.
For repair, contact Omron representatives.

Do not hold the side of the front panel when lifting. 

- Injury may result if the panel comes off and falls.

Keep plastic package bags out of reach of children. 

- Children may suffocate if they place their heads into plastic bags.

Make sure to connect the unit's AC input plug to a commercial power source with rated input voltage (200/208/220/230/240VAC) and 50/60Hz frequency. 

- Connecting to a commercial power source with a different rated input voltage or frequency may result in a fire.
- The unit may fail.

For BU5002RWLG, when an abnormality (unusual sound or smell) occurs, disconnect the AC input plug from the wall outlet, or turn OFF the INPUT PROTECTION switch (input overcurrent protection switch) on the back of the unit. The socket-outlet shall be installed near the equipment and shall be easily accessible. 

For BU2002RWLG and BU3002RWLG, turn OFF the external breaker installed on the input side.

- When performing maintenance on the connected devices, follow the above instructions to ensure safety.

Do not connect devices such as dryers, some solenoid valves, etc. , which have a half-wave rectifier that allows only half-cycle AC power to flow through. 

- Overcurrent may damage the UPS.

Connect the unit to a wall outlet (commercial power) with the appropriate capacity (11A or greater for BU2002RWLG, 16A or greater for BU3002RWLG and 27A or greater for BU5002RWLG). 

- Otherwise, the power cord may be heated.
- When equipment with the maximum output capacity is connected, a maximum current of 11A (BU2002RWLG), 16A (BU3002RWLG), or 27A (BU5002RWLG) flows.

When changing the input cable, make sure to perform the connection as specified. 

- When connecting a cable to the terminal block, use a cable that complies with the input current specification of the UPS.
- Failure to do so may result in electric shock or ground fault.

**Caution (for installation and connection)**

When in use, make sure the output terminal block cover is attached. Do not turn ON the power switch when it is detached.



- Voltage is applied to the output terminal block when the power switch is ON, which can result in electric shock.

Provide secure grounding.



- For AC input plug connection, connect the plug directly to a commercial power source. For terminal block connection, connect the cable to a commercial power source and ground it. A failure or leak that occurs when the unit is not properly grounded may result in electric shock.

Do not disassemble, repair, or modify the unit.



- Doing so may cause an electric shock or a fire.

Do not install the unit in other than specified orientations.



- Dropping or toppling the unit may cause injury.
- If you install the unit in an orientation other than specified, the unit cannot be protected from a battery fluid leakage.

Do not use the unit where the maximum temperature exceeds 40°C.



- The battery becomes weak rapidly, which may cause a fire.
- Doing so may cause a failure or malfunction of the unit.

Do not exceed the ranges specified for environmental conditions during use/storage.



Do not install or store the unit in the places listed below.

- Do not store in places where the humidity is lower than 10% or higher than 90%.
- Do not use the unit in places where the ambient temperature is lower than 0°C or higher than 40°C. (With no condensation)
- Do not use in places where the humidity is lower than 10% or higher than 90%.
- Do not install/store the unit in closed places such as cabinets with no clearance, places where there is flammable or corrosive gas, places with large amounts of dust, places exposed to direct sunlight, places exposed to shock or vibration, salty or wet places, or outdoors.
- Installation or storing the unit in such a place may cause a fire.

Do not connect equipment that exceeds the output capacity of the unit.



You can use a plug strip to connect additional devices, but do not connect devices that exceed the current capacity of the plug strip.

- The current protection of the unit may operate, which may stop the output.
- The wiring of the plug strip heats up, which may cause a fire.

Do not pinch or sharply bend the cable.



Do not fold or knot the cable.

Doing so may cause the cable to be damaged or heated, which may cause an electric shock or a fire.

- If the cable is damaged, stop using the unit and have the cable repaired.
For repair, contact Omron representatives.

The accessories are designed exclusively for use with this unit.



Do not use any of the included accessories with other devices.

- Doing so may compromise the safety of devices.

Do not block the air vents (front and rear).



- Doing so will cause the internal temperature to rise, which may cause the unit to fail and the battery to deteriorate.
- Leave at least 5 cm of space between the front vent and the wall, and at least 10 cm of space between the rear vent and the wall.

2. Installation and connection



Caution (for installation and connection)

Do not connect devices that cannot be used with commercial power supply.



- When the unit's power switch is turned ON and an error occurs with the connected device, bypass operation is performed and commercial power supply is supplied as is to the connected devices.

When installing the unit on a rack, place it on the lower shelf.



- Injury may result if the unit falls.

Make sure to use the mounting screws included with the brackets.



- Mounting screws other than those included may not be strong enough to support the unit, causing it to fall.
- If you attach the case using long screws other than those included with the product, you may damage the internal parts of the unit.

When using the unit in the 100V output mode, check that the output voltage is set to 100V, and then turn ON the power switch.



- Connecting a 100V device to the unit while outputting in the 200V mode may cause a failure of the device or a fire.
- The output voltage can be set with "Settings" - "In/Out Settings" - "Output Voltage" in the menu on the LCD.

Notes

When moving the unit from a cold place to a warm place, leave it for several hours before using it.

- If the unit is promptly turned ON after being moved to a warmer place, condensation may form inside the unit and cause it to fail.

Charge the battery soon after purchasing the unit.

- The battery self-discharges even when it not being used, and it goes into over-discharge state if it is left for a long period of time.
- The battery can be charged once the AC input plug is connected to a commercial power source.

When storing the unit, charge the battery for at least 8 hours and turn OFF the power switch.

- Even if the unit is not used, the battery gradually discharges, and if it is left for a long time, it goes into an over discharge state.
The backup time may become shorter or the battery may become unusable.
- Connect the unit to a commercial power source for at least 12 hours every 6 months when the storage temperature is 25°C or less, or every 2 months when the storage temperature is 40°C or less.
- Turn off the power switch of the unit during storage.

Do not short the output lines of the unit to each other, and do not short the output lines to the ground.

- The unit may fail.

Do not connect the AC input plug of the unit to its Power Supply Output Receptacle during the Battery Mode.

- The unit may fail.

Do not connect a page printer (such as a laser printer) to the unit.

- The unit repeatedly and frequently switches between Commercial Power Mode and Battery Mode, which may shorten the life of the battery.
- The page printer has a large peak current, so an excess of the connection capacity or a power failure due to instantaneous voltage drop may be detected.

Do not install or store the unit in a place exposed to direct sunlight.

- The rise of temperature may cause the built-in battery to deteriorate rapidly and become unusable.

Do not perform withstand voltage tests.

- Performing withstand voltage tests may damage the surge absorption element built into the power supply input circuit.
- When performing an insulation resistance test, use the 400 VDC range.

Before stopping the commercial power to the unit, turn OFF the power switch of the unit.

- The unit enters Battery Mode when commercial power is stopped. If you frequently use the unit in Battery Mode, the battery life may be significantly shortened.

If this unit is used for an inductive device such as a coil or motor, check the operation beforehand.

- With some types of devices, the effect of inrush current may cause this unit to stop operating properly.

The battery contains dilute sulfuric acid which is a toxic substance. If fluid leaks from the battery, do not let it contact your skin or clothes. If contacted, wash it out with clean water. In particular, if the fluid gets in your eyes, immediately wash them with clean water and seek medical treatment.

Check system operation beforehand if the unit is used in combination with a device whose power supply voltage and frequency fluctuate widely, such as a generator.

- If the generator's output voltage/frequency falls out of the input voltage/frequency range, the unit will enter Battery Mode.
- Even if the input frequency is within the range, the unit will enter Battery Mode when a rapid change (5 Hz/sec or greater) occurs.

2. Installation and connection

2-2 Installation

The UPS permits the following installing methods. Choose the one best suited for the environment.

2-2-1. Rackmount installation

2-2-2. Stationary installation

- Horizontal
- Upright installation

Do not use this unit in any position other than the “correct positions” indicated in the illustration below.

Note

Before installing this device, make a record of the serial number of this device. The product serial number is required when contacting us about the device. The serial number (S/N) is inscribed on the bottom left side of the rear panel. The product serial number is inscribed on the bottom left side of the rear panel. The product serial number label is also included.

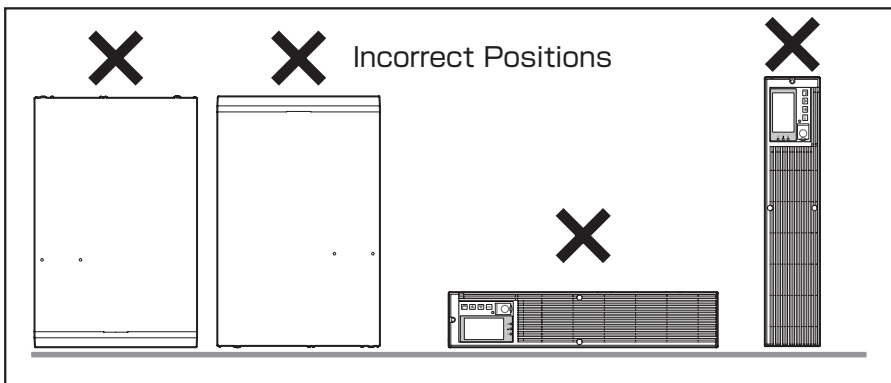
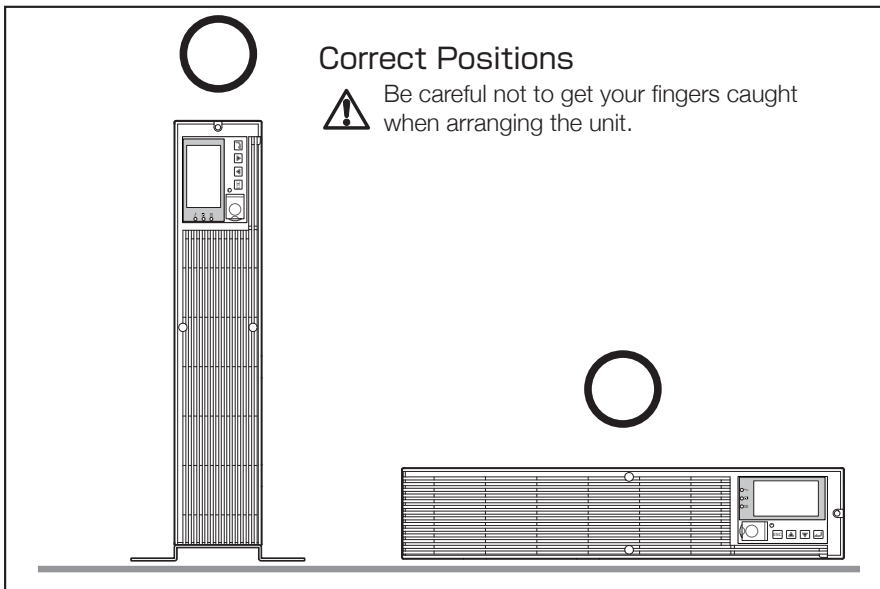

2-2-1. Rackmount installation (EIA /JIS 19-inch rack/server rack)

 **Caution**

When performing rack installation, ensure that the UPS is supported and stabilized by using both the support angles and the table clamps that were included. 

- When installing on a rack, make sure that the UPS is supported by the each unit individually.
- When installing on a rack, make sure to use the support angles and table clamps included with the product. Without the support angles, the front clamp alone cannot support the weight of the UPS.
- The mass of each unit: BU2002RWLG: Approx. 28kg BU3002RWLG: Approx. 33kg
 BU5002RWLG: Approx. 61kg



In a case where the UPS is to be mounted on a rack, place it on the lower part of the rack. 

- Dropping it may result in injury.

Be sure to use the supplied mounting screws. 

- Use of long screws other than those supplied for case mounting may damage inside the unit.
- Screws other than those supplied may not be strong enough to support the UPS, causing it to fall.

● Items included in the 19-inch rack support angle mounting bracket set

Rack rail (front) L/R	1 each	
Rack rail (rear) L/R	1 each	
Unit guide rail L/R	1 each	
Ear bracket L/R	1 each	
Spacers	2	
Bracket mounting screws (M4)	10	
EIA/JIS rack fixing screws (M5)	10	
EIA rack fixing nuts (M5)	10	

● Rack mounting procedure

- (1) Insert the 2 included bracket mounting screws (M4) and half-tighten them to hold the front and rear rack rails in place. ①

There are two types of front and rear rack rails: left (L) and right (R).

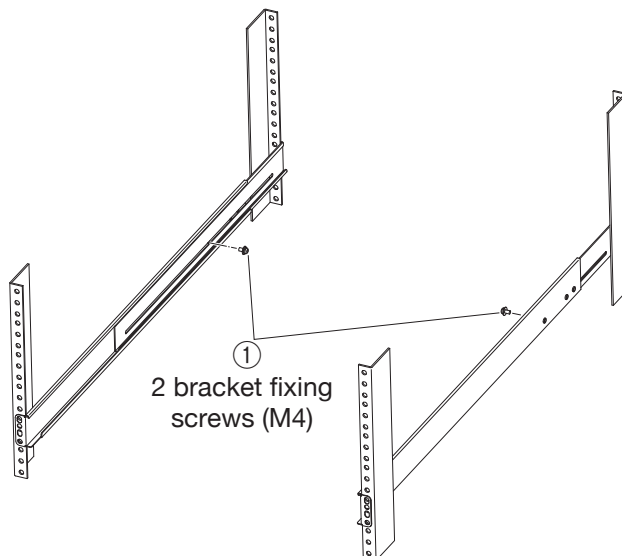

2. Installation and connection

- (2) Adjust the length of support angles to suit the server rack, and then securely tighten the screws that were half-tightened in step 1. ②
- (3) For EIA standard-compliant installation, use the included EIA rack fixing nuts (M5) and EIA/JIS rack fixing screws (M5) to securely fasten the front and the back of the rack rails to the server rack. ③ The screw hole positions are as follows.
 - EIA rack: Topmost one for the front, topmost and bottommost ones for the rear
 - JIS rack: One at the second from the bottom for both front and rear

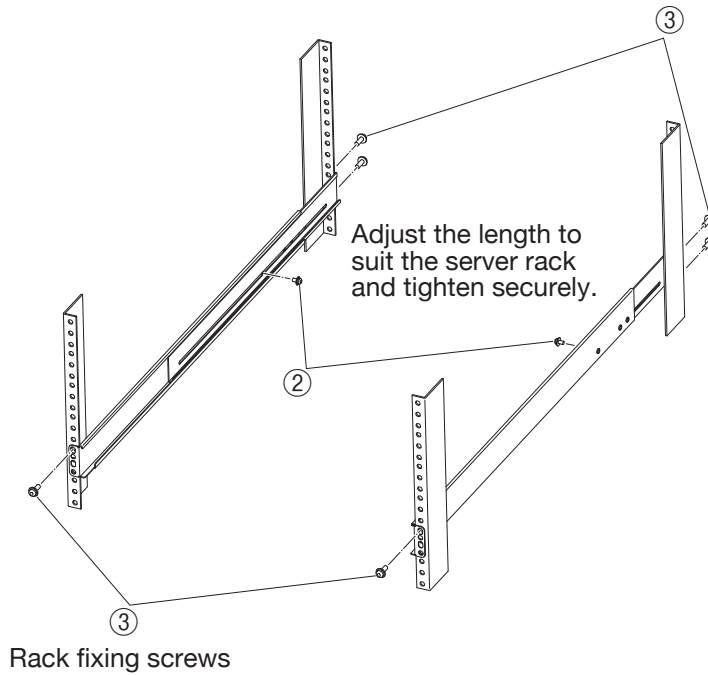

- (4) Use the 8 included bracket fixing screws (M4) (2 sets of 4 screws) to securely fasten the ear brackets and unit guide rails to the left and right sides of the UPS. ④ (Installation is possible without removing the handles on the sides of BU5002RWLG; do not remove them.)

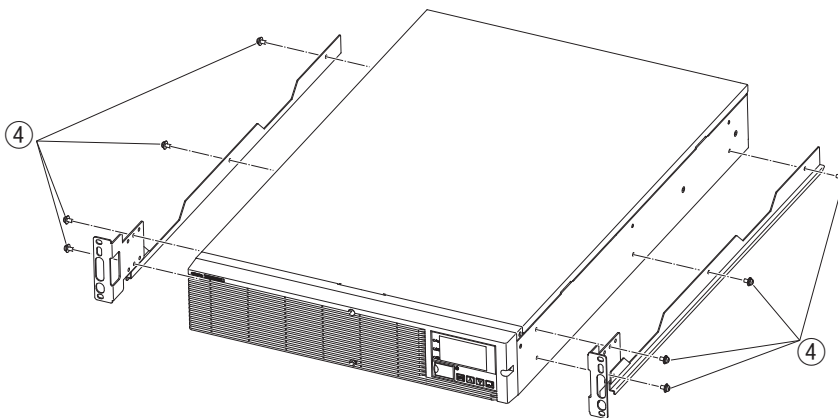

The support angles cannot be attached to special EIA/JIS racks.

- (5) Place the UPS on the support angles and push it completely into the rack (5), and use the included EIA/JIS rack fixing screws (M5) and spacers to securely fasten the ear brackets to the server rack. (6) The screw hole positions are as follows.
- EIA rack: Topmost and bottommost ones on the front
 - JIS rack: One at the second from the top on the front

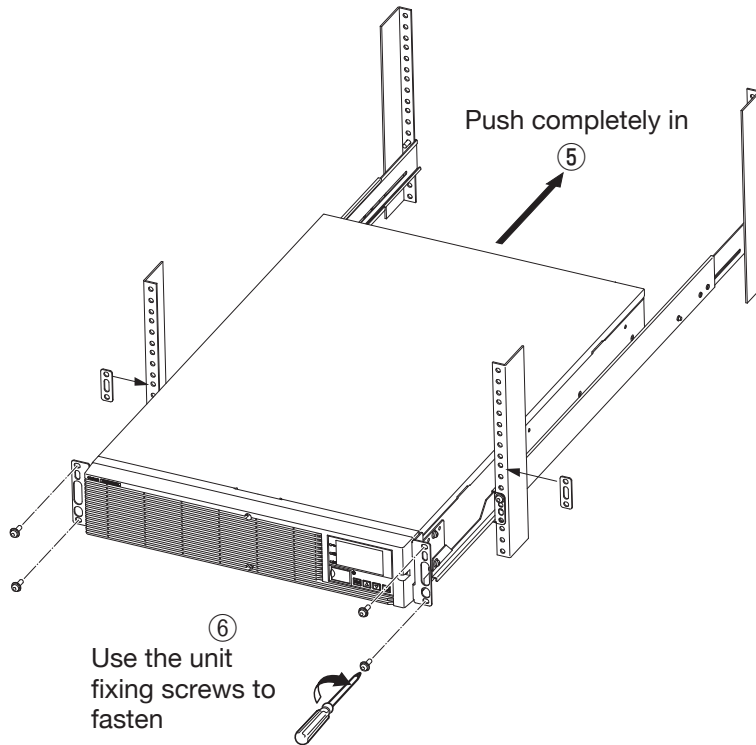

⚠ Always use the support angles.

Note

The batteries for BU5002RWLG are in a separate package. Attach the batteries to the unit before installation. For the attachment procedure, refer to "6-2 Replacing the battery".

2. Installation and connection

2-2-2. Stationary installation

Perform installation only as shown in the diagrams below.

● Horizontal installation

Attach the included rubber feet for horizontal installation with the included M3 screws and position the unit horizontally.

For stationary horizontal installation, make sure that this product does not slide or fall. (Installation is possible without removing the handles on the sides of BU5002RWLG; do not remove them.)

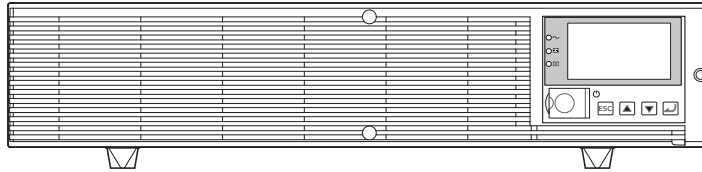

● Upright installation

(1) Upright installation

Use the upright stands included with the product.

Attach the two upright stands (front and back) for BU2002RWLG and BU3002RWLG, and three (front, center, and back) for BU5002RWLG with the included screws.

Keep a space of 250 mm or more above the UPS.

(Installation is possible without removing the handles on the sides of BU5002RWLG; do not remove them.)

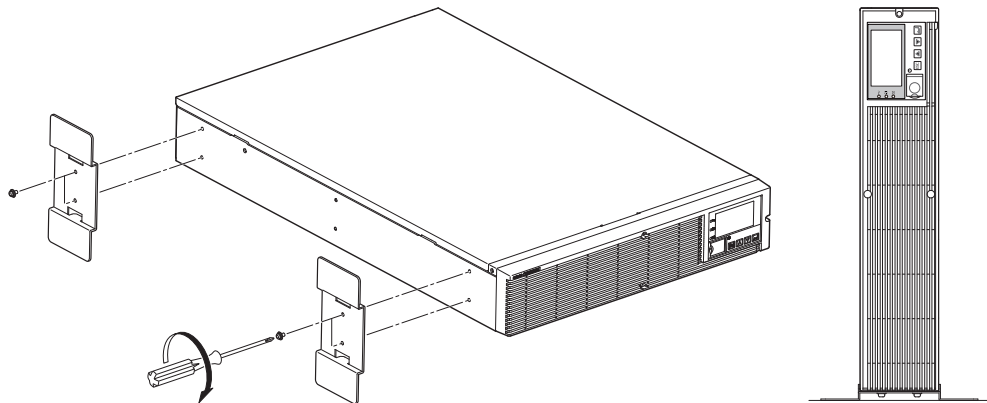

Note

The batteries for BU5002 G are in a separate package. Attach the batteries to the unit before installation. For the attachment procedure, refer to "6-2 Replacing the battery".

2-3 Connecting the equipment

Caution

Do not connect devices with rated voltage of 200 to 240/100VAC or higher. 

- The rated output voltage of this device is 200 to 240/100VAC.
- Overcurrent may damage the connected devices.

2-3-1. Connecting a device to the power supply output (AC receptacle) (BU5002RWLG only)

- (1) BU5002RWLG comes equipped with two "NEMA L6-30R" AC receptacles. Only devices with rated voltage of 200 to 240 VAC can be connected to these AC receptacles. Connect devices with rated voltage of 100 VAC to the AC output terminal block.
- (2) Connect devices you want to back up to the Power Supply Output Receptacles of the UPS.
 - If you need more output receptacles than those of the UPS, supply additional output receptacles.

< Example of connection for BU5002RWLG >

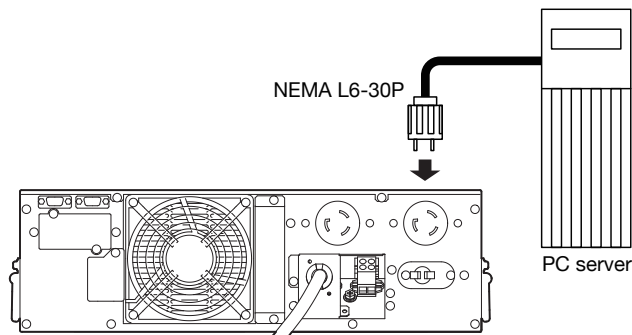

2. Installation and connection

2-3-2. Connecting a device to the power supply output (AC output terminal block)

⚠ Caution

When in use, make sure the output terminal block cover is attached. Do not turn ON the power switch when it is detached. 

- Voltage is applied to the output terminal block when the power switch is ON, which can result in electric shock.

When connecting a device to the output terminal block, make sure to include an emergency stop switch (ESD) between the unit and the load.

- In the event of an accident, the power supply to the device can be stopped by pressing the emergency stop switch.
- To reduce the risk of fire, connect only to an emergency stop switch (ESD) with a minimum rating of 250V/15A (BU2002RWLG), 250V/20A (BU3002RWLG), or 250V/30A (BU5002RWLG). When the unit is used in compliance with UL standards or CE marking, follow the National Electrical Code (ANSI/NFPA 70).
- Install the emergency stop switch where it is easy to operate.

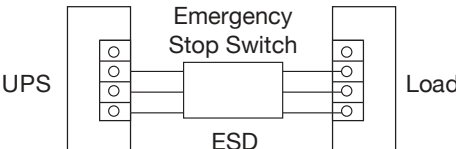

The diagram illustrates the electrical connection between a UPS (Uninterruptible Power Supply) and a Load. On the left, the UPS is represented by a vertical terminal block with four terminals. On the right, the Load is represented by a similar vertical terminal block with four terminals. In the center, an Emergency Stop Switch (ESD) is shown as a rectangular box. Wires connect the UPS terminals to the ESD, and the ESD terminals to the Load terminals. The ESD is labeled 'Emergency Stop Switch' and 'ESD'.

- (1) Connect the devices that require backup to the power supply output terminal block of the unit. Check that one terminal block cover and three M3 screws are included in the accessories. BU2002RWLG and BU3002RWLG require two M3 screws, and BU5002RWLG requires one M3 screw. (The remaining M3 screws are spares.)
Run the wires to be connected through the hole in the terminal block cover (with cable clamp). (See Figure 1.)
If you have trouble running the wire through the hole, loosen the cable clamp dial by turning it counter-clockwise.
Crimp the specified round terminal to the ground wire, and tighten the ground terminal screw. (See Figure 2.)
Use a flat head screwdriver to loosen the terminal block screws, insert the wire stripped to the specified length into the terminal block from the bottom at an angle as far as it will go, and then retighten the terminal block screws. (See Figure 3.)
The wire connected to the G terminal should be longer than the wires connected to L1 and L2. Refer to Table 1 for wire sizes.

G terminal : Connect the ground wire

L1 terminal : Connect the line

L2 terminal : Connect the neutral line

Figure 1

BU2002RWLG/BU3002RWLG

BU5002RWLG

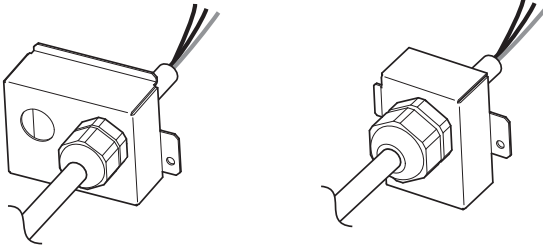
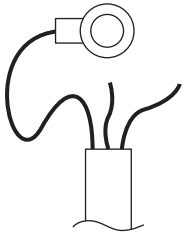

Figure 2



Crimp the round terminal to the ground wire.
 BU2002RWLG/BU3002RWLG : For M4 screw
 BU5002RWLG : For M5 screw

2

Figure 3

BU2002RWLG/BU3002RWLG

BU5002RWLG

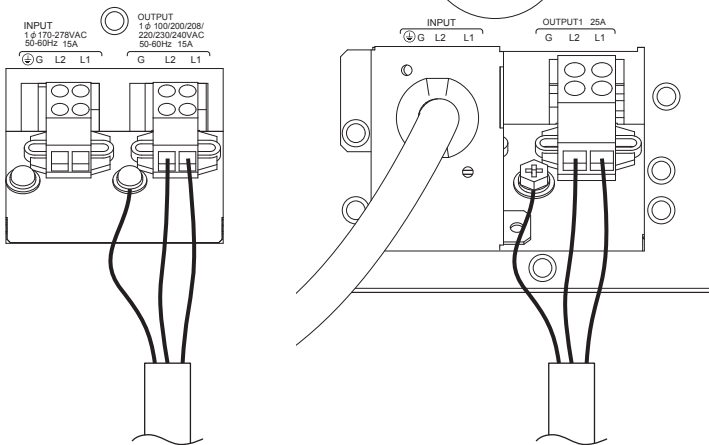

Table 1

	BU2002RWLG BU3002RWLG	BU5002RWLG
Connectable wire size	0.5 to 4mm ²	1.5 to 6mm ²
Amount of stripped wire	6 to 8mm	9 to 11mm
Tightening torque	0.49N•m	1.18N•m
Recommended cable size	2mm ² (AWG14)	3.5mm ² (AWG12)

2. Installation and connection

- (2) Attach the terminal block cover (with cable clamp) to the unit. For BU2002RWLG and BU3002RWLG, attach the cover after connecting the input cable.

BU2002RWLG/BU3002RWLG

Insert the upper part of the terminal block cover into the slit of the unit, and tighten it with two of the included M3 screws.

Tighten the cable clamp dial to stabilize the wire.

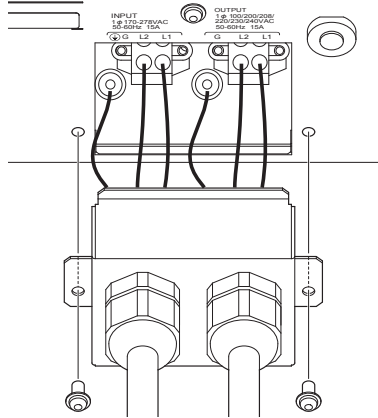

BU5002RWLG

Insert the tab on the left side of the terminal block cover into the slit of the input terminal block cover, and then run one of the included M3 screws through the hole on the right side of the terminal block cover and tighten it.

Tighten the cable clamp dial to stabilize the wire.

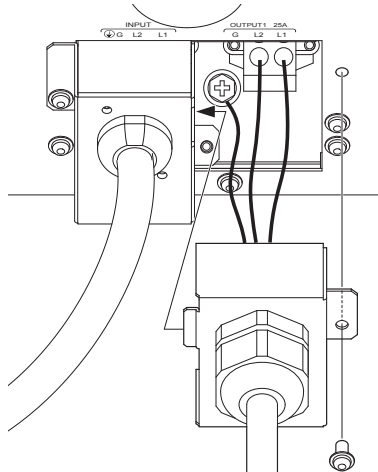

2-3-3. Connecting to a computer

When using the included UPS monitoring software or the contact signal, use the connection cable to connect the unit to the PC.

See also "7. Using the UPS monitoring software and Contact Signal" on page 38.

* If you do not use the UPS monitoring software and Contact Signal, this step is not required.

2-4 Connecting the AC input

When installation and connection are complete, connect the unit's AC input to a commercial power source.

Caution

Make sure to connect the AC input plug of the unit into a wall outlet (commercial power) with rated input voltage (200/208/220/230/240VAC). 

- Connecting to a wall outlet (commercial power) of a different rated voltage may result in fire.
- The unit may fail.

2-4-1. Connecting the AC input plug (BU5002RWLG)

- Use the 15A plug included with the product at shipment.
Provide a wall outlet (commercial power) suitable for the shape of the 15A plug (NEMA 5-15R).

Caution (for installation and connection)

When the AC input power supply is grounded to the negative terminal, make sure to use this unit's N terminal (phase) side as the ground (L2). 

- A misconnection may result in malfunction.
- BU5002RWLG Input plug (NEMA L6-30P)
(Front view)



Make sure to connect the input plug to a wall outlet equipped with a grounding terminal.

- Doing so may result in electric shock.

- Provide a wall outlet (commercial power) compatible with the shape of the 30A plug (NEMA L6-30R).



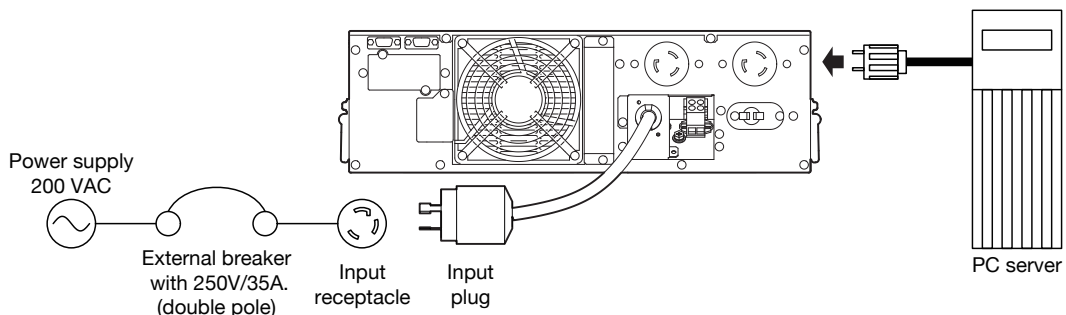

< Example of connection for BU5002RWLG >



- The unit was charged before shipment, but it may have self-discharged during shipment, resulting in a reduced backup time.
We recommend charging the unit before use.
- You can perform "2-5 Checking the operation" on page 21 also before charging the battery.

2. Installation and connection

2-4-2. Connecting to the input terminal block (BU2002RWLG/BU3002RWLG/BU5002RWLG)

 Caution (for installation and connection)	
<p>When connecting the AC input directly from a power switchboard, make sure that the wiring work is performed by a qualified electrical engineer (with Type II certification or higher).</p> <ul style="list-style-type: none"> ● To use the BU2002RWLG with up to 2000VA/1400W, a wiring capacity of 11A or required. ● To use the BU3002RWLG with up to 3000VA/2100W, a wiring capacity of 16A or required. ● To use the BU5002RWLG with up to 5000VA/3500W, a wiring capacity of 27A or required. 	
<p>Make sure to properly match the AC input terminal with the appropriate wire color. Turn off the external breaker when performing work on the unit's AC input terminals. Be sure to attach the AC input terminal block cover.</p> <ul style="list-style-type: none"> ● Failure to do so may result in electric shock or ground fault. 	
<p>Include a breaker (double pole) between the unit and the commercial power, and install the breaker where it is easy to operate.</p>	

Connection procedure

- (1) Remove the terminal-cover of the AC input terminal block.
- (2) Run the wires through the terminal block cover (with cable clamp).
- (3) Connect the ground wire to the G terminal. Use a flat head screwdriver to loosen the terminal block screw, insert the wire, and then retighten the screw.
- (4) Connect the neutral line to L2, and connect the line to L1.
Connections to the terminal block shall comply with the standards in Table 1.
- (5) Fix the terminal block cover with the screws, and then turn the clamp to stabilize the wires.

Table 1

	BU2002RWLG BU3002RWLG	BU5002RWLG
Connectable wire size	0.5 to 4mm ²	1.5 to 6mm ²
Amount of stripped wire	6 to 8mm	9 to 11mm
Tightening torque	0.49N•m	1.18N•m
Recommended cable size	2mm ² (AWG14)	3.5mm ² (AWG12)

(Example of connection)

<BU2002RWLG/BU3002RWLG>

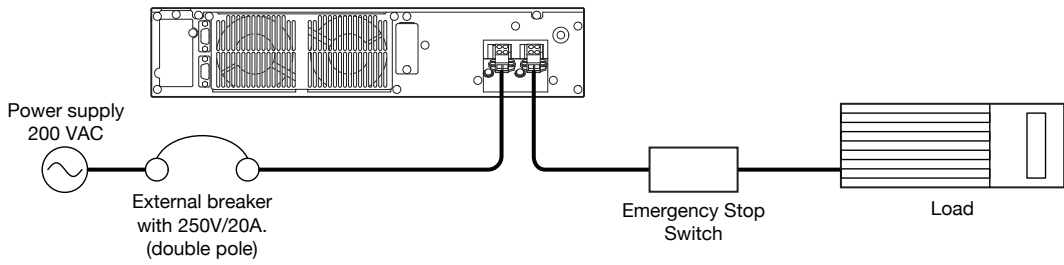

<BU5002RWLG>

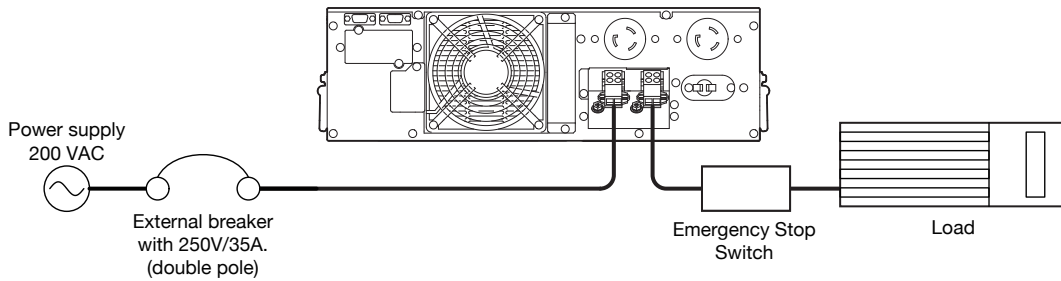

- The unit was charged before shipment, but it may have self-discharged during shipment, resulting in a reduced backup time. We recommend charging the unit before use.
- You can perform "2-5 Checking the operation" on page 21 also before charging the battery.

2-5 Checking the operation

When you finish connecting the unit, confirm that the backup operation works properly.

Check that the Battery Mode is performed normally according to the following procedure.

(In this operation check, the effects of a power failure are reproduced by disconnecting the AC input plug from the wall outlet (commercial power).)

(1) Press and hold the unit's power switch for 3 seconds or longer to turn ON the power.

The beeper sounds and the current settings are displayed on the LED.
Self-diagnosis starts automatically.

When the self-diagnosis test finishes normally, the unit's operation switches to commercial power and the status indication below is displayed.

Status indicator	Description
	Power switch "ON" Operating normally

○ ON ● OFF ⊗ ON, OFF, or blinking depending on status

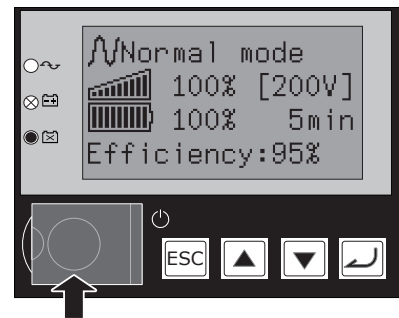

(2) Bring all the connected devices into operation.

(Including devices connected to the AC outlet of your PC.)

The unit was charged before shipment, but it may have self-discharged during shipment, resulting in a reduced backup time. We recommend charging the unit before use.

(3) Under this condition, check the the unit's LCD and beep sound.

Are they in the same status as shown below?

Status indicator	
Beep	None
Power supply output receptacles	Outputs power (connected devices are powered)

If the same as the one shown above: → The operation is normal. Proceed to (4).

If not the same as the one shown above: → The operation is abnormal. One of the cases described in "4. Display and beeps when there is an equipment failure" of "3-3 Interpreting beeps and displays" on page 29 must apply.



Take necessary measures and then proceed to (4).

(4) Disconnect the unit's AC input plug from the wall outlet (commercial power). When the AC input cable is connected to the terminal block, turn off the external breaker.

The unit enters Battery Mode.

(5) In Battery Mode, check the unit's LED display and beep sound.

Does the status indicator appear as one of those shown below?

Status indicator	Beep	Output	Description
	Intermittent 4-second intervals	ON	Backup is operating due to power failure or AC input error. Output will stop if Battery Mode continues.
	Intermittent 1-second intervals	ON	(Same as above.) Battery level is low, so output will stop soon.
	None	OFF	Battery is dead, so output stopped.

If not the same as one of those shown above: → Operation is abnormal. Check the status of lamps and beep, and then press and hold the power switch for 3 seconds or longer to turn OFF the power.

- If the display is one of those shown in "4. Displays and beeps when there is an equipment failure" in "3-3 Interpreting beeps and displays" on page 29, take the necessary measures and then go back to (1) on page 21.
- If no Battery Mode is performed and the UPS and the devices connected to the UPS stop, this may be attributed to an insufficient battery charge.
After connecting the AC input plug to a wall outlet (commercial power) and charging the battery, go back to step (4) on page 21.
- If the problem persists after checking the 2 points above, contact Omron representatives.

 Beeper ON/OFF can be set with "Settings" - "Local Setting" - "Audible alarm" in the menu on the LCD.

(6) Reconnect the AC input plug to the commercial power source. When the AC input cable is connected to the terminal block, turn on the external breaker.

The status indicator returns to its normal state and the beeping sound stops.
(The status is as shown below.)

Status indicator	Description
	Power switch "ON" Operating normally

Checking the operation is now complete.

Installation and connection is now complete.

2-6 Charging the battery

The battery automatically starts charging when the unit is connected to a commercial power source.

(This occurs regardless of whether the power switch is ON or OFF.)

The charging takes 8 hours to complete.

- The unit was charged before shipment, but it may have self-discharged during shipment, resulting in a reduced backup time. We recommend charging the unit before use.
- If you do not perform the initial backup time measurement described below in "2-7 Measuring the initial value of backup time", proceed to "3. Operation. → Page 24"

2-7 Measuring the initial value of backup time

- When you measure the backup time initial value of the unit in your environment, this value can be used as a guide when checking the battery and deciding the UPS monitoring software setting values.

 "5. Measuring the backup time" → Page 34

2-8 Recharging the battery

The battery is discharged completely when the backup time is measured, so you need to recharge it before using the UPS.

- You can use connected devices while recharging the battery, but the backup time when a power failure occurs is shorter until the battery is fully charged.

(If a power failure occurs immediately after the start of charging, backup stops immediately.)

 Charge the battery as described in "2-6 Charging the battery."

Preparation for starting operation is now complete.

3

Operation

3-1 Precautions and notes for operation

Take notice of following items during operation.

Caution (for use)

Do not allow the unit to come in contact with water. Do not drop the unit. 

- Doing so may cause an electric shock or a fire.
- If the unit becomes wet, immediately stop using it, disconnect the AC input cable from commercial power and have the unit inspected and repaired.
For repair, contact Omron representatives.

When the battery is dead, replace it immediately or stop using the unit. 

- Continuing the use of it may cause fire or electric shock due to liquid leaks..

Ambient temperature	Expected life
25°C	5 years
35°C	2.5 years

* The values in the table are the expected life under standard use conditions and are not guaranteed.

Using a dry cloth, periodically wipe the dust from the AC input plug and power supply output receptacles. 

- Accumulated dust may cause a fire.

Do not use the unit in a closed place and do not cover the unit. 

- Doing so may cause abnormal heating or a fire.

If you notice an abnormal sound or smell, smoke, or leaking fluid, immediately turn OFF the unit's power switch and stop the supply of commercial power. 

- Using the unit under such conditions may cause a fire.
- If you notice such a condition, stop using the unit and contact Omron representatives for inspection and repairs.
- Position the unit in such a way that you can immediately disconnect the AC input plug from the wall outlet (commercial power) in the event a problem occurs.

If fluid leaks from the unit, do not touch the fluid. 

- Doing so may cause blindness or burns.
- If the fluid contacts your eyes or skin, wash it out with lots of clean water and consult your doctor.

Do not place objects heavier than 25kg on the unit, and do not drop heavy objects onto the unit. 

- Doing so may cause distortion/damage to the case or a failure of the internal circuit, which may cause a fire.

The unit is equipped with a bypass circuit which is able to supply electric power to connected devices even when the inner control circuit is broken down by defects or malfunctions 

- Output is continuing even when all indicators of the front panel are off.
- If you want to stop the output, either stop the source of commercial power, or disconnect the AC input plug from the wall outlet (commercial power).

Do not sit or stand on top of the product, use it as a step ladder, or lean against it. 

- Doing so may cause the unit to fail or to fall over and result in injury.

3.Operation

Notes

Before stopping the commercial power to the unit, turn OFF the power switch of the unit.

- The unit enters Battery Mode when commercial power is stopped. If you frequently use the unit in Battery Mode, the battery life may be significantly shortened.

Take measures for handling unforeseen accidents, such as data backup and system redundancy.

- The output may stop when there is a circuit failure in the UPS.

Explanation

Usual operation

- You may either leave the power switch of the unit ON (operation status) or turn it OFF each time when stopping the connected system. Choose whichever operation method is more convenient. We recommend turning OFF the power switch when you do not use connected devices for a long time.
- The battery can be recharged once the AC input plug is connected to commercial power.

Quitting Battery Mode

- If a power failure lasts for an extended period of time, the battery discharges and power output from the unit stops. Shut down your computer after performing appropriate procedures (for example, saving data) while the unit is still supplying power.

Rebooting

- If the battery discharges completely during a power failure, the unit stops. After recovery from the power failure, the unit automatically restarts and supplies power. If you do not want to restart the connected devices, disable the "Settings" - "Boot Settings" - "Auto reboot" setting in the menu on the unit's LCD, or turn OFF the power switch of the connected devices.

Scheduled operation using the UPS monitoring software

- When performing scheduled operation in which the UPS is stopped and a device such as a breaker is used to stop the UPS at the same time that commercial power stops, specify a period of no more than 3 months for the start of the next operation. If you specify a period longer than 3 months, the internal timer is reset and the scheduled operation does not start.

Note that this period reduces to less than half when the battery needs to be replaced.

If a period of 3 months is exceeded, you start operation by supplying commercial power and pressing the Start Switch. However, if the battery needs to be replaced, you may not be able to start operation. In this case, replace the battery.

3-2 Start and stop procedures and basic operation

The UPS status indicators and UPS setting change menu are displayed on the control display panel on the front of the unit.

● UPS status indicators (status screen)

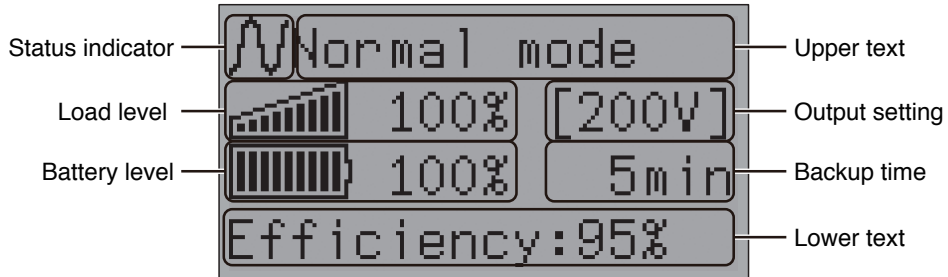

● UPS setting change menu screen

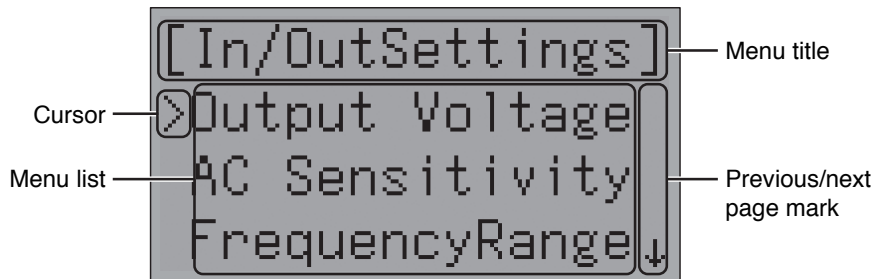

Basic operations on the menu screen

Switch	Description
[▲][▼]	Move cursor up/down or increase/decrease values
[↵]	Selection of menu or determine the value
[ESC]	Return to menu or cancel

3.Operation

- **When the unit is connected to a commercial power source with the power switch OFF and commercial power is supplied to it**

- The status indicator displays " ".
- Power output is stopped.
- The battery automatically starts recharging.
- The standby screen appears on the LCD.

- **Start procedure**

Operation Press and hold the power switch of the UPS for 3 seconds or longer.

- After a few seconds, output begins in inverter operation.
- The status indicator displays " ", and the self-diagnostic test is performed.
- When the self-diagnosis test finishes normally, the unit enters the normal operating state through inverter operation.
- When the self-diagnostic test is not performed, AC output begins immediately inverter operation.



Status indicator	Beep	Output	Description	Solution
	None	ON	Commercial Power Mode	-

- During operation, the battery is charged automatically.

● **Operation after a power failure**

- If a power failure or abnormal input power supply occurs, the UPS automatically switches to Battery Mode, continuing power output from the Power Supply Output terminal block supplied from the battery.
- The LCD and the beeper's intermittent sounds alert the user.

 "Local Settings" in the menu on the LCD can be used to set the beeper ON/OFF.

Status indicator	Beep	Output	Description	Solution
	Intermittent 4-second intervals	ON	Backup is operating due to power failure or AC input error.	Shut down the connected devices to stop them.
	Intermittent 1-second intervals	ON	Battery level is low, so output will stop soon.	
	Intermittent 2-second intervals	OFF	Battery is dead, so output stopped.	Charge the battery.

● **Operation during recovery from a power failure**

- The unit automatically resumes output via commercial power if it recovers from a power failure/input power supply error while it is providing power supply output. The spent battery starts charging.
- If a power failure or abnormal power input is resolved after the battery is discharged completely and power output is stopped, the UPS restarts automatically and resumes power output. The expended battery begins to charge.

 "Boot Settings" in the menu on the LCD can be used to enable or disable auto restart.

● **Stop procedure**











 **Press and hold the power switch of the UPS for 3 seconds or longer.**

- The power output from the UPS stops.

Status indicator	Beep	Output	Charging	Description
	None	OFF	ON	Power switch OFF

- Even if you turn off the power switch, if AC is supplied from commercial power, the battery is automatically charged.

3-3 Interpreting beeps and displays

No.	Status indicator	Mode	Beep	Description	Solution
1		Standby Mode	None	Power switch OFF Operation stopped	-
2		Commercial Power Mode	None	Power switch ON Operating normally	-
3		Bypass Mode	None	AC input is bypassed to the output due to an internal failure of the UPS or other reason	Refer to the message displayed on the LCD.
4		Test Mode	None	Self-diagnostic test in progress	Commercial Power Mode is recovered after a certain period of time.
5		UPS Event	None	Waiting; startup conditions are not fulfilled	Refer to the displayed message.
6		Battery Mode	Intermittent 4-second	Backup is operating due to power failure or AC input error	Shut down the connected devices to stop them.
7		Battery Low	Intermittent 1-second	Battery level is low, so output will stop soon	Shut down the connected devices to stop them.
		Battery Empty	Intermittent 2-second	Battery is dead, so output stopped	Charge the battery.
8		Battery Deterioration	Intermittent 2-second	Battery has deteriorated	Replace the battery.
9		Overload	Intermittent 0.5-second	High connection load	Reduce the connection load.
10		UPS Failure	Continuous	Failure or warning has occurred	Refer to the message displayed on the LCD.

● **Load/battery level meter**

The load level meter displays the power consumption of the connected devices as a percentage.
 BU2002RWLG: Displayed in 10 levels, with 100% indicating 2000 VA/1400 W.
 BU3002RWLG: Displayed in 10 levels, with 100% indicating 3000 VA/2100 W.
 BU5002RWLG: Displayed in 10 levels, with 100% indicating 5000 VA/3500 W.



The battery level meter displays the remaining battery level as a percentage.



4

UPS functions

4-1 Suspending a beep

When the beep is sounding, you can suspend it by pressing and holding the beep ESC switch for 0.5 seconds or longer.

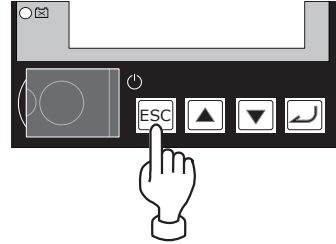

4-2 Self-diagnosis test

This test performs a failure diagnosis on the unit and performs a test to check for battery deterioration. Use the procedure below to check whether a circuit failure has occurred inside the unit and whether battery replacement is required.

This test is performed if the “Power” switch is ON or performed automatically (You do not have to perform any special operations). Automatic test is performed once every 4 weeks after the unit is connected to a commercial power source and power distribution begins.

If the battery is not charged for at least 24 hours, the self-diagnostic test is not executed immediately. After charging is complete, it is automatically executed.

- (1) When the self-diagnostic test is executed, the Battery Mode starts automatically (No beep sounds). After the test is complete, the normal operation automatically starts.
- (2) If an error message appears on the LCD:
Follow the directions for the solutions described earlier in this document.

* This test can also be run from the included UPS monitoring software.
For more details, refer to the online help for the UPS monitoring software.

4. UPS functions

4-3 Battery life counter function

This function notifies you with LCD and beep sound when the battery needs to be replaced. The battery life counter operates while commercial power is supplied after shipment. (When the ambient temperature of the battery is higher than 25°C, the value of the counter will be incremented at a faster pace.)

When the battery needs to be replaced, the battery replacement lamp will light up and beep will sound.

* Be sure to reset the battery life counter after replacing the battery.

4-4 Operation panel setting

A list of menu items on the LCD is shown in the table below. Menu items displayed vary depending on the menu type setting.

The menu type can be set with “Settings” - “Local Settings” - “Menu Type”. There are two types of menu: “Standard Mode” (for general users) and “Advanced Mode” (for administrators).

<Meaning of the Note column>

*1: Displayed only when the menu type is “Advanced Mode”. (Not displayed in “Standard Mode”.)

*2: The setting can be changed only when the UPS is stopped. During operation, the setting can be checked but not changed.

	Menu	Description	Note
Measurements	Load Meter	Display the applied load in VA and W.	
	Input/Output	Display the input/output voltage and frequency.	
	Battery Meter	Display the status of the built-in battery.	
	Longevity	Display the estimated lifespan of the UPS in 5 levels.	
	Efficiency	Display the efficiency of the UPS as a percentage.	*1
	Cumulat. Power	Display the amount of power used so far and the number of days elapsed.	*1
	Average Power	Display the average amount of power used so far.	*1
Control	Function Test	Perform a self-diagnosis and a test to check for battery deterioration, and then display the results.	
	ResetB.L.cnt	Reset the battery life counter.	
	Reset Failure	Reset a failure.	
	ResetPow.Usage	Reset the values of cumulative power usage and average power usage.	*1
	DryContactTest	Perform a contact signal test.	*1 *2
	Maintenance	Move to Bypass Mode forcibly.	*1
	Initialization	Return each of the UPS settings to the factory settings.	*1 *2

Menu		Description	Note	
Settings	Local Settings	Language	Set the language to be displayed on the LCD.	
		LCD Setting	Change the contrast of the LCD.	
		LCD Auto off	Set the amount of time after which the LCD turns off automatically.	
		LCD Test	Check that the LCD and LEDs light up.	
		Audible alarm	Set the beeper status.	
		Calendar	Set the calendar information for the UPS.	
		UPS Inst. Date	Set the date you started using the UPS.	
		UPS life count	Set the UPS life counter status.	
		Menu Type	Select the menu to be displayed. "Standard" displays frequently used items only.	
	In/Out Settings	Output Voltage	Set the output voltage. * When this product is used in compliance with UL standards, do not set 100V output mode.	*2
		Frequency Range	Switch the frequency range mode.	*1
	Boot Settings	Auto reboot	Set auto restart from power failure.	
		Delay time	Set the delay time for recovery from power failure.	*1
		Battery level	Set the battery voltage for restarting the UPS.	*1
		Reboot Mode	Set the mode for rebooting.	*1
		Power SW off	Switch the operating mode of the power switch.	*1
	Batt. Settings	Function Test	Set the timing at which to execute the self-diagnostic test.	
		Bat.L.Counter	Set whether to be notified of the battery life.	
		Bat.Inst.Date	Set the date you replaced the battery.	
		Max.BackUpTime	Set the output of the UPS to stop after a specified amount of time.	*1
Low Battery		Set the level at which to detect low battery.	*1	
Settings	Dry Contact	BS Valid Range	Set the status for receiving the BS signal.	*1
		BS Delay Time	Set the delay time for the BS signal.	*1 *2
		BU Delay Time	Set the delay time for the BU signal.	*1
		DryCont. Logic	Set the logic of each contact signal.	*1
		Remote Logic	Set the logic of the remote signal.	*1



4. UPS functions

	Menu	Description	Note
Identification	Type	Display the names of the UPS and battery pack.	
	Serial Number	Display the serial number of the UPS.	
	Firmware Ver.	Display the firmware version of the UPS.	*1
	Memorandum	You can record information of 20 alphanumeric characters.	*1
Log	Fault Log	Display up to 10 fault log records (time of occurrence and details of each failure).	*1
	Shutdown log	Display up to 10 reasons for shutdown of the UPS.	*1
	Event Log	Display up to 10 event log records.	*1
	Reset all log	Clear each log.	*1

5

Measuring the backup time

5-1 How to measure backup time

The backup time you measure for the first time after purchase is the “initial value of the backup time.” You can precisely judge the deterioration condition of the battery if you measure the “initial value of the backup time” in advance at the time of a battery check.

- (1) Connect to commercial power and charge the battery for 8 hours (Charging time is extended 24 hours per unit, if additional battery unit is connected).
- (2) Turn ON all devices connected to the unit.
- (3) Turn off the commercial power and measure the backup time.
In Battery Mode, measure the time until the unit automatically stops and all displays disappear.

The power supply output of the unit will stop when the battery discharges. Conduct measurement under a condition in which no problem occurs even if the power supply of the connected device stops during the process. Do not conduct measurement if there is a possibility of a failure when the power supply stops.

5-2 Estimated backup time

- (1) Convert the total capacity (power consumption) of the connected devices to watts (W).
For the indication of connected devices, check your computer and the rear of the display.
The indicator can show values in three different ways: volt-amperes (VA), amperes (A), and watts (W).

Example 1) 200 VAC, 50/60Hz, 145 W

Example 2) 200 VAC, 50/60Hz, 1.8 A

Example 3) 200 VAC, 50/60Hz, 150 VA

Indication	Value
VA	× power factor = W
A	× power factor × power supply voltage = W

For devices that use the VA or A indication, convert the capacity into W. Multiply the value indicated on devices by the value in the right table for conversion.

(When the power factor is unknown, enter “1”. The power factor usually ranges between 0.6 and 1.)

- (2) Add the values converted into W to obtain the total capacity of the connected devices.
- (3) Calculate the initial value of the backup time for the total capacity of the connected devices from the graph below.
 - Graph of backup time (graph of initial values for products that have not been used at 25°C)
The backup time becomes shorter than the graph (table) below when temperature is lower.
 - The smaller the capacity of connected devices becomes, the longer the backup time becomes.

5. Measuring the backup time

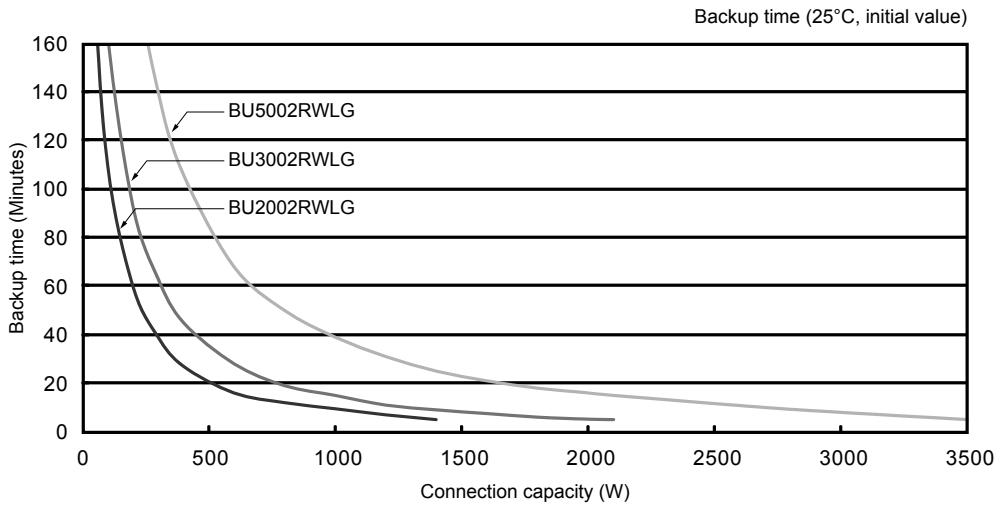

Backup time table

Time unit: (Minutes)

BU2002RWLG

Connection capacity (W)	20	50	100	200	300	400	600	800	1000	1200	1400
Backup time (Minutes)	360	190	110	60	39	27	16	12	9.5	7	5

BU3002RWLG

Connection capacity (W)	20	50	100	200	300	400	600	800	1000	1200	1400	1600	1800	2000	2100
Backup time (Minutes)	450	260	165	93	63	45	28	19	15	11	9	7.5	6	5.2	5

BU5002RWLG

Connection capacity (W)	20	50	100	200	300	400	600	800	1000	1200	1400	1600	1800	2000	2100	2700	3000	3500
Backup time (Minutes)	660	480	320	200	140	106	68	50	39	31	25	21	18	16	15	10	8	5

* These backup times are for reference only. Times may vary according to battery life and external environmental conditions (temperature, etc.).



Caution (for maintenance)

When maintaining the connected equipment, turn OFF the unit's power switch to stop the output, and stop the supply of commercial power.



- Even if commercial power to the UPS is stopped while it is in operation, the power output of this unit does not stop and power is supplied from the receptacle.

Do not disassemble, repair, or modify the unit.



- Doing so may cause an electric shock or a fire.

If fluid leaks from the unit, do not touch the fluid.



- Doing so may cause blindness or burns.

- If the fluid contacts your eyes or skin, wash it out with lots of clean water and consult your doctor.

Do not throw the unit into fire.



- The lead battery in the unit may explode, or leak dilute sulfuric acid.

Do not insert metal objects into the power supply output receptacles of the UPS.



- Doing so may result in electric shock.

Do not insert metal objects into the battery connectors.



Do not create a short between the connector terminals.

- Doing so may cause an electric shock.

6-1

Checking the battery

The lead battery used in the unit has a limited lifespan.

(The life varies depending on your storage/use environment and backup frequency.)

The nearer the end of the life is, the more rapidly deterioration proceeds.

1. Battery life expectancy (* Not a guaranteed performance)

Ambient temperature	Battery life expectancy
25°C	5 years
35°C	2.5 years

2. Methods for checking the battery

There are two methods for checking the battery.

- Perform a self-diagnostic test. (See page 30.)
- Measure the backup time. (See page 34.)

By measuring the backup time, the battery life can be determined more accurately.

- When you compare the "initial value of the backup time" you measured and the current backup time, make the capacity of devices connected to the UPS same as when you measured the initial value to make judgment accurately.

6. Maintenance and Inspection

3. Guidelines for how often to check the battery (measure the backup time)

Average ambient temperature	6-month check	Monthly check
25°C	For the first 4 years after starting use	When 4 years or more have passed after starting use
35°C	For the first 2 years after starting use	When 2 years or more have passed after starting use

* The battery deteriorates even if it is stored. The higher the temperature is, the shorter the life becomes.

6-2

Cleaning

1. Cleaning the UPS

Moisten a soft cloth with water or detergent, squeeze it tightly, and wipe the product lightly.

Do not use chemicals such as thinner and benzene. (They cause deformation or discoloration.)

2. Removing dust from the AC input plug, power supply output receptacles, input terminal block, and output terminal block of the UPS

Stop all the connected devices and the UPS and disconnect the AC input plug from a wall outlet (commercial power).

Then, remove dust with a dry cloth and make the connection again.

(For information on the connection procedure:)

 "2-3 Connecting the equipment" → Page 14

Using the UPS monitoring software and contact signal

*** If you do not use the UPS monitoring software and contact signal, this step is not required.**

■ UPS monitoring software

"PowerAct Pro" and "Simple Shutdown Software" is included with this product. Refer to the table below for details about compatibility. Choose which one to use based on the application. Refer to the table below for details about compatibility. For further details about the software functions, refer to the separate "UPS Monitoring Software Quick Installation Guide."

• UPS monitoring software selection table

OS	Communication method	UPS monitoring software	Required options (sold separately)	Reference
Windows 8 Windows 7	Serial (RS232C)	PowerAct Pro 5/4 (Note 1) Simple Shutdown Software (Note 1)	-	→ See 7-1
Windows Vista Windows Server2012 Windows Server2008 (including R2) Windows Storage Server2012 Windows Storage Server2008 (including R2)	LAN	PowerAct Pro 5/4 (Slave Agent) (Note1)	-	→ See 7-1
Windows server2003 x64 Edition	Serial (RS232C)	PowerAct Pro 5/4 (Note 1) Simple Shutdown Software (Note 1)	-	→ See 7-1
Windows XP x64 Edition	LAN	PowerAct Pro 5/4 (Slave Agent) (Note1)	-	→ See 7-1
Windows server2003 Windows XP	Serial (RS232C)	PowerAct Pro 5/4 (Note 1) Simple Shutdown Software (Note 1)	-	→ See 7-1
	LAN	PowerAct Pro 5/4 (Slave Agent) (Note1)	-	→ See 7-1
Linux (Note 2) Unix	Serial (RS232C)	PowerAct Pro (Note 1) Simple Shutdown Software (Note 1)	-	→ See 7-1
	LAN	PowerAct Pro 5/4 (Slave Agent) (Note1) Shutdown Agent	-	→ See 7-1
Mac OS X v10.8/v10.7/ v10.6/v10.5 Mac OS X Server v10.8/ v10.7/v10.6/v10.5	LAN	PowerAct Pro 5/4 (Slave Agent) (Note1)	-	→ See 7-1
VMware	LAN	PowerAct Pro 5/4 (Slave Agent) (Note1)	-	→ See 7-1

Note 1: The most recent version can be downloaded from our homepage (industrial.omron.eu).

Note 2: Files cannot be automatically saved.

Note 3: The UPS automatically stops once the battery is depleted.



Caution

When this product is used in compliance with CE marking, please use under 3m connection cable.

7. Using the UPS monitoring software and contact signal

• UPS monitoring software function list

●Supported ▲Limited —Unsupported

Function		Software title	General applications (Simple functions, standalone)	Network management applications (Advanced functions, network support)
			Simple Shutdown Software	PowerAct Pro 5/4
Required options			—	—
Software function	Auto shutdown (*1)		●	●
	UPS monitoring (operating status)		—	●
	UPS monitoring (data)		—	●
	Pop-up notification		—	●
	End when OS is inactive (*3)		—	●
	Schedule operation		—	●
	UPS setting change		—	●
	External command execution		●	●
	Event log save		—	●
	Data log save		—	●
	Coordinated shutdown (shutdown of multiple units)		—	●
	Output receptacle control		—	●
	Redundant power supply support		—	●
	Remote UPS management		—	●
	Mail send		—	●
Telnet connection		—	—	
SYSLOG support		—	●	

*1) The UPS automatically stops only when the battery is depleted. (Battery Mode continues until the battery is depleted.)

*2) Only the battery capacity can be monitored.

*3) This function is available only for Windows, not for Linux.

[Explanation of software functions]

1	Auto shutdown	The computer can be shut down automatically when a problem occurs with the power supply.
2	UPS monitoring (operating status)	The operating status of the UPS can be monitored (in Commercial Power Mode/Battery Mode).
3	UPS monitoring (data)	Monitoring can be performed for input voltage value, connection capacity, battery capacity, etc.
4	Pop-up notification	When a problem such as a power failure occurs, a pop-up window that shows the details of the problem can be displayed.
5	Shutdown when OS is inactive	Shutdown can be performed when the computer is in an inactive state. The operating status is retained at shutdown in inactive state, so operation details are not lost.
6	Schedule operation	Schedule settings can be made for UPS stop/start.
7	UPS setting change	UPS settings (beep ON/OFF, etc.) can be changed. (Items that can be set vary according to the UPS.)
8	External command execution	By executing commands at shutdown, items such as application programs can be launched.
9	Event log save	Information of events that occur on the UPS (power supply problems, setting changes, occurrences of failure, etc.) are saved as a log.
10	Data log save	Data of input/output voltage value, connection capacity, etc. is periodically saved as a log (the save frequency can be set).
11	Coordinated shutdown	When a problem occurs with the power supply, multiple computers connected to the UPS can coordinate to perform auto shutdown.
12	Output receptacle control	The UPS output receptacles can be individually set to ON/OFF.
13	Redundant power supply support	Two or more UPS can be connected to computers equipped with redundant power supply. Shutdown is not performed when a power supply problem affects only one of the units. Shutdown is performed only when a power supply problem occurs with both UPS, so the system's operating rate is improved.
14	Remote UPS management	The UPS can be managed remotely from a computer on the network.
15	Mail send	When a problem such as a power failure occurs, a notification email describing the problem can be sent to the system administrator.
16	Telnet connection	Settings such as shutdown parameters can be made via the Telnet connection.
17	SYSLOG support	UPS management information can be recorded in SYSLOG.

7-1

When using the included UPS monitoring software to perform auto shutdown

• When using PowerAct Pro

"PowerAct Pro" UPS monitoring software

The included "PowerAct Pro" UPS monitoring software allows you to perform shutdown processing of your PC when a power failure occurs.(It is possible to shut down multiple computers on the network.)

Also, you can perform desired operation by setting the automatic start/stop of the UPS based on the schedule setting.

* The time between the occurrence of a power failure and the shutdown of your PC must be within the backup time measured in "5-1 How to measure backup time" on page 34.

For more information, refer to the Instruction Manual and online help of the UPS monitoring software.

• When using Simple Shutdown Software

The included "Simple Shutdown Software" allows you to automatically shut down the PC when a power failure occurs. For more information, refer to the manual in the CD-ROM.

1. Connect the UPS to a computer.

Cable: Included connection cable (RS-232C)

<RS-232C>

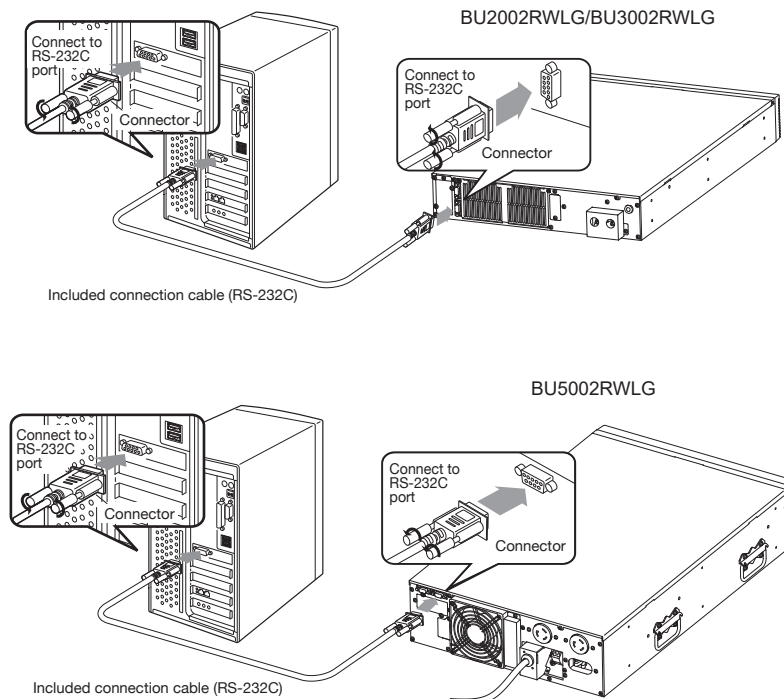

7. Using the UPS monitoring software and contact signal

* When connecting 2 or more computers to the UPS (Only when using PowerAct Pro)

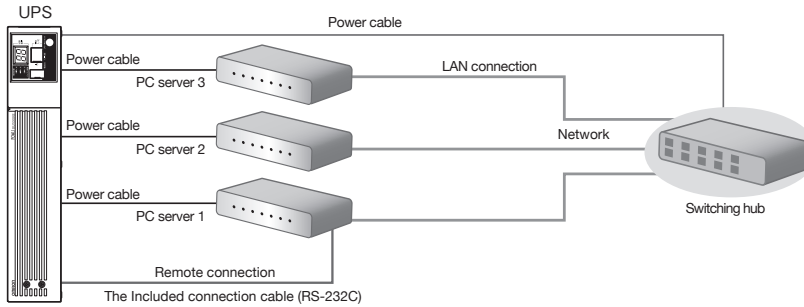

2. Install the included “PowerAct Pro 5/4” or “Simple Shutdown Software” to the PC you want to shutdown.

Installation method:

For “PowerAct Pro 5/4”, refer to the installation guide (for Windows) in the CD-ROM, or the separate “Quick Installation Guide for UPS Monitoring Software”.

Refer to the manual in the CD-ROM for “Simple Shutdown Software.”

Explanation

Scheduled operation using the UPS monitoring software

● When performing scheduled operation in which the UPS is stopped and a device such as a breaker is used to stop the UPS at the same time that commercial power stops, specify a period of no more than 3 months for the start of the next operation.

If you specify a period longer than 3 months, the internal timer is reset and the scheduled operation does not start.

Note that this period reduces to approximately half when the battery needs to be replaced.

If a period of 3 months is exceeded, you start operation by supplying commercial power and pressing the Start Switch. However, if the battery needs to be replaced, you may not be able to start operation.

In this case, replace the battery.

Start of operation in scheduled operation using the UPS monitoring software

● To manually start up this unit after it has been stopped by a scheduled operation, turn OFF the power switch and turn it back ON again.

To stop the unit when it is in operation, turn OFF the power switch.

Auto restart after OS closing processing using the UPS monitoring software

● When a power failure occurs, certain PCs (*1) automatically restart immediately after the OS is shut down by auto shutdown.

In this case, the UPS stops during or after the restart of the PC, which may damage files and the hard disk. You can avoid this phenomenon by disabling POWER MANAGEMENT in the BIOS settings of the PC.

*1) Certain PC: It is known that this phenomenon occurs for MICRON's Millennia Mme.

Precautions when “setting the UPS to stop automatically” after OS shutdown

● If, after a power failure occurs, the power is restored while auto shutdown processing is being performed, UPS output stops once after the set time elapses. After shutdown processing is complete, do not turn ON the computer until the UPS has finished restarting.

7-2

Contact signal (NPN OUTPUT)

Contact signals are included as standard for the unit.

Contact Signal

You can develop your unique system based on the following specifications to automate the process at a power failure. You can perform power-failure processing by allowing the system to detect the backup signal and also perform system shutdown processing by allowing the system to detect the Low battery level signal. Also, by inputting the backup stop signal from the system, you can stop the UPS with a sufficient battery level to prepare for the next occurrence of a power failure.

*The standard UPS connection signal is NPN.
To use a PNP connection, please adopt SC08G(option).
For details, refer to the instruction manual that comes with the SC08G.

7

7-2-1. Signal output

The UPS has 4 kinds of output signals. The output circuit consists of an open collector circuit using a photo coupler (a kind of electronic switch).

● **Backup Signal output: BU**

Stays ON during backup operation at a power failure.

BU-COM	ON when a power failure occurs
--------	--------------------------------

● **Low battery level signal output: BL**

Goes ON when the battery becomes weak during backup operation at a power failure.

BL-COM	ON when the battery is low
--------	----------------------------

● **Trouble Signal output: TR**

Goes ON when a failure of the UPS occurs or when the battery life counter expires.

TR-COM	ON when a power failure occurs
--------	--------------------------------

● **Battery Replacement Signal output (WB)**

Goes ON when the test determines that battery replacement is necessary due to deterioration or when the battery life counter goes off-scale.

WB-COM	ON when replacing the battery
--------	-------------------------------

7-2-2. Signal input

● **Input of the UPS Stop Signal (BS)**

BS-COM	UPS stops
--------	-----------

When the BS signal is ON (High), the output of the UPS is stopped after the time period specified in advance has elapsed. The following settings are available on the LCD.

(1) BS Valid Range: "Settings" - "Dry Contact" - "BS Valid Range"

- Always enabled : The BS signal is received either in Commercial Power Mode or Battery Mode.
- Enabled during Battery Mode: The BS signal is received only in Battery Mode.

(2) BS Delay Time: "Settings" - "Dry Contact" - "BS Delay Time"

You can set the amount of time between when the BS signal is received and when the output of the UPS is stopped.

7. Using the UPS monitoring software and contact signal

● Remote ON/OFF Signal

Remote ON/OFF signals can be used to start and stop the UPS, by using either an externally connected contact or the ON/OFF status of the open collector circuit.

Connection terminals are at contact signal connector pins 6, 7.

External contact	Operate
Open	Start
Close	Stop

7-2-3. Contact signal I/O connector (female DSUB9P)

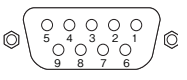
Pin assignment	Pin number	Item
 <p>Front view Screw size: inch screw #4-40 UNC</p>	1	Battery LOW signal output (BL)
	2	Trouble signal output (TR)
	3	Backup stop signal input (BS)
	4	NC
	5	COMMON (COM)
	6	Remote ON/OFF input (-)
	7	Remote ON/OFF input (+)
	8	Backup signal output (BU)
	9	Deteriorated battery signal output (WB)

Note: The COMMON (COM) terminal (pin 5) is connected to the frame ground.

7-2-4. Contact Signal ratings

● Signal output (BL, TR, BU, WB)

Photo coupler ratings Input voltage:
Applicable voltage: 35VDC or less
Maximum current: 50 mA

● UPS Stop Signal input (BS)

HIGH(ON) 5 to 24 VDC
LOW(OFF) 0.7 VDC or less

● Remote ON/OFF

Voltage between terminals: 5 VDC
Current when closed: 10 mA max.

7-2-5. Contact Signal circuit inside the UPS

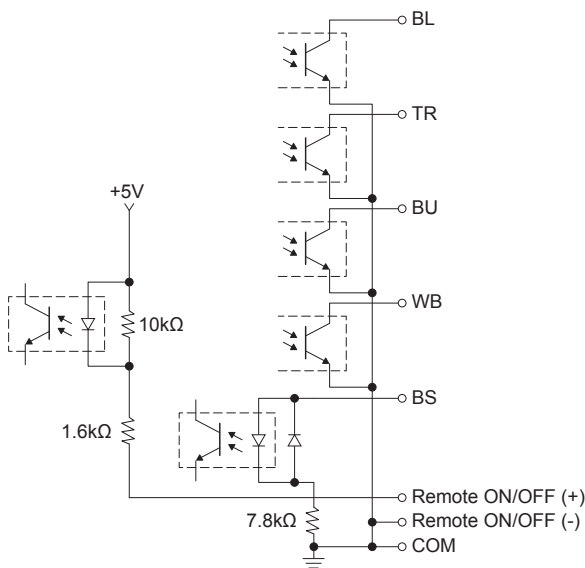

7-2-6. Example of the use of the Contact Signal circuit

● Example of BU signal output circuit and the connected circuit

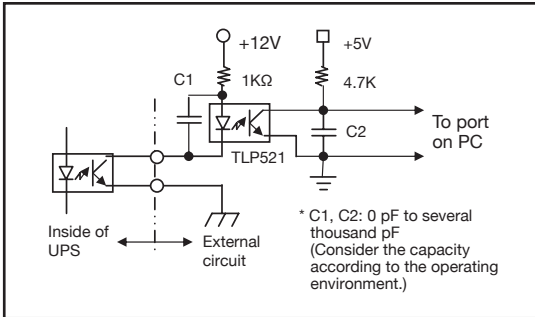

● Example of BS signal input circuit and the connected circuit

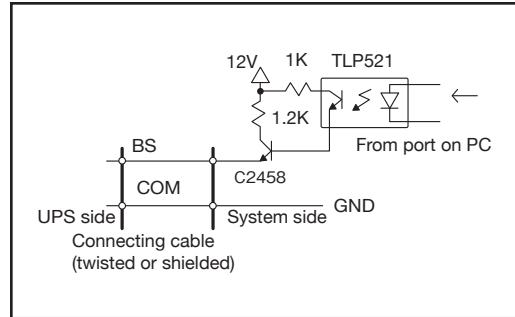

● Remote ON/OFF circuit

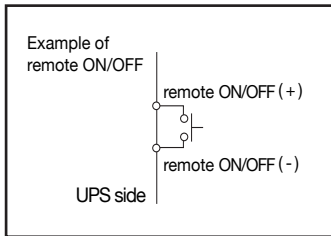

7-2-7. Precautions and notes for the use of the Contact Signal

Notes

- When connecting a device such as a relay that generates counter electromotive force to the signal output circuit, connect diodes that prevent counter electromotive force to both ends of the relay.

Explanation

- When power is restored after the unit stopped automatically during a power failure, the unit automatically restarts and supplies power. If you do not want to start the connected devices, turn OFF their switches or set the auto startup setting after recovery from power failure ("Settings" - "Boot Settings" - "Auto reboot" on the LCD) to "disable". (See page 32.)

8

Troubleshooting

Perform the checks shown below if the unit is operating abnormally.

If the unit continues to operate abnormally, please contact Omron representatives.

Problem	Check and remedy
The LCD does not appear when the UPS is connected to commercial power and the power switch is turned ON.	<ol style="list-style-type: none"> 1. Make sure the AC input is securely connected to commercial power. 2. AC input overcurrent protection is activated and power is cut. (For BU2002RWLG and BU3002RWLG, the black button has popped up. For BU5002RWLG, it is tilted towards OFF.) <ul style="list-style-type: none"> • If the black INPUT PROTECTION button pops up, there are too many connected devices or there was a short-circuit with the connected devices. Disconnect all the connected devices, press the black INPUT PROTECTION switch (overcurrent protection switch), and turn on the power switch. • If the status indicator does not display properly after you perform the above operation, there is a problem with the unit. (See “3-3 Interpreting beeps and displays” on page 29.)
Backup is not possible. The computer stops when a power failure occurs.	The battery may not be fully charged. Perform the test after charging the battery for at least 8 hours. The battery can be charged just by connecting to a wall outlet. The “Power” switch can be either ON or OFF.
Backup is performed too frequently. Frequent switching is performed although a power failure does not occur. You hear the sound of switching.	<p>Variations (decrease) in the input power occur frequently. Or, noise may be included that significantly distorts the voltage waveform of the input power.</p> <ul style="list-style-type: none"> • Try and check what happens when connecting the unit to a different wall outlet (commercial power) located some distance away from the device consuming a large amount of power. • This problem may occur also when you connect many devices to a plug strip or extension cord connected to the UPS if it is a long or thin cable.
Does not turn ON when power switch is pressed.	The unit does not start up when the input power supply voltage/frequency is abnormal. (“AC I/P abnormal” is displayed on the LCD.) Check the voltage and frequency of the input power supply. See also A. Specifications Input voltage range, Input frequency see Page 48.
<p>The display is abnormal.</p> <ul style="list-style-type: none"> • The display is unstable. • White lines occur. • Noise increases. 	<p>The probable cause is noise that occurs inside the UPS.</p> <ul style="list-style-type: none"> • Ground all devices connected to the UPS. Connect them to a wall outlet (commercial power) for 3-pin plugs or connect their Grounding Terminal to the Grounding Terminal of a wall outlet. • This problem may occur when power cords are long or placed closely or when the UPS and devices to be backed up are placed closely. Rearrange them. • If the UPS or devices connected to the UPS are contained in a metal rack, attempt to ground the rack itself.
The battery replacement lamp lights up or blinks, and the beeper sounds at 2-second intervals.	<ul style="list-style-type: none"> • When the battery replacement lamp blinks: Judged as battery deterioration by self-diagnosis test. Replace the battery as only the short backup operation time is available. See also 4-2 Self-diagnosis test → page 30 • When the battery replacement lamp is ON: Battery life counter went off-scale. The life of the battery has expired. Replace the battery. See also 4-3 Battery life counter function → page 31
“Overload” is displayed.	There are too many connected devices. Reduce the number of connected devices until the error is resolved.
“Over load time out” is displayed.	Output stopped due to exceeded connection capacity. Turn OFF all power to the unit and connected devices, and reduce the number of connected devices. Then, turn the power to the unit and connected devices back ON and check whether the error is resolved.

References

A. Specifications

	BU2002RWLG	BU3002RWLG	BU5002RWLG
Operation method	Full-time inverter supply method (high efficiency)		
AC input	Rated input voltage AC200/208/220/230/240V		
	Startup voltage range 200V mode: 160±2 to 288±2 VAC, 208V mode: 167±2 to 278±2 VAC 220V mode: 176±2 to 278±2 VAC, 230V mode: 184±2 to 278±2 VAC 240V mode: 192±2 to 278±2 VAC, 100V mode: 160±2 to 288±2 VAC		
	Input voltage range 200V mode: 170±2 to 278±2 VAC, 208V mode: 177±2 to 278±2 VAC 220V mode: 186±2 to 278±2 VAC, 230V mode: 194±2 to 278±2 VAC 240V mode: 202±2 to 278±2 VAC, 100V mode: 170±2 to 278±2 VAC		
	Input frequency 50/60 Hz±1, 3, 5, or 14% (5% in the factory settings)		
	9A/11A	14A/16A	23A/27A
	Phase Single-phase, two-wire (grounded)		
	Input plug Terminal block		NEMA L6-30P / Terminal block
	Input protection NFB		
	Input protection capacity 16A		30A
AC output	Output capacity (upper limit) 2000VA/1400W (1000 VA/700 W in 100V mode)		
	10A	15A	25A
	Rated current (output rating voltage) Uninterrupted		
	Switching time Uninterrupted		
	Commercial direct shipment (switching time) Uninterrupted		
	Output voltage (commercial operation) 200Vmode: AC200V±2%, 208Vmode: AC208±2% 220Vmode: AC220V±2%, 230Vmode: AC230±2% 240Vmode: AC240V±2%, 100Vmode: AC100V±5%		
	Output voltage (backup operation) 200Vmode: AC200V±2%, 208Vmode: AC208±2% 220Vmode: AC220V±2%, 230Vmode: AC230±2% 240Vmode: AC240V±2%, 100Vmode: AC100V±5%		
	Output frequency (commercial operation) Synchronized with input frequency		
	Output frequency (backup operation) 50/60Hz±0.5Hz		
	Output waveform (In Commercial Power Mode/Battery Mode) Sine wave / Sine wave		
	Waveform distortion rate 7% max. (Rectified load, at rated output) 3% max. (Resistance load, at rated output)		
	Phase Single-phase, two-wire		
	Output receptacles Terminal block		NEMA L6-30R x 2, terminal block
Battery	Sealed lead battery life expectancy 5 years (ultralong operating life) (ambient temperature 25°C)		
	12 VDC/ 9 Ah (x 4)	12 VDC/ 9 Ah (x 6)	12 VDC/ 9 Ah (x 12)
	Charging time 8 hours		
	5 min. (1400 W)	5 min. (2100 W)	5 min. (3500 W)
	Backup time (25°C, initial characteristics)		
	Dimensions (W x D x H mm) 430 x 660 x 88 (2U)		
	430 x 700 x 132 (3U)		
	Weight of unit Approx. 28kg		
	Approx. 33kg		Approx. 61kg
	Operating environment temperature/humidity 0°C to 40°C, 25 to 85%RH with no condensation		
	Storage environment temperature/humidity -15°C to 50°C, 10 to 90%RH (with battery fully charged, stored with no condensation)		
	Noise regulation VCCI Class A compliant		
	Safety standard compliance UL1778/CE/RoHS compliance		
	70W (*1)/145W (*2)	148W (*1)/265W (*2)	249W (*1)/480W (*2)
	Internal power consumption (normal/maximum)		
	Noise 45 dB max.		
	50 dB max.		
	Cooling method Forced air cooling		
	Serial communication (RS-232C) (interface) ●(D-sub 9pin)		
	Contact signal (interface) ●(D-sub 9pin)		

*1: Rated load/ Rated input voltage/ When fully charged

*2: Rated load/ Rated input voltage/ When battery charge current is at maximum

B. Dimensions

- BU2002RWLG/BU3002RWLG <Unit: mm/ Tolerance: ± 2 mm for total length, ± 1 mm for other measurements>

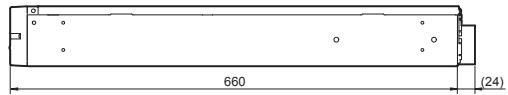
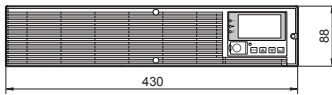
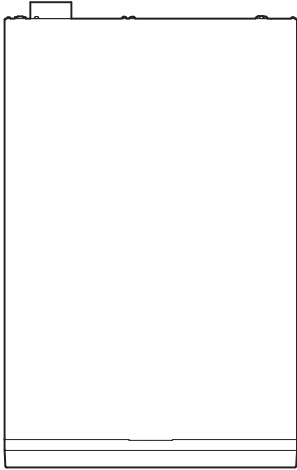

- BU5002RWLG <Unit: mm/ Tolerance: ± 2 mm for total length, ± 1 mm for other measurements>

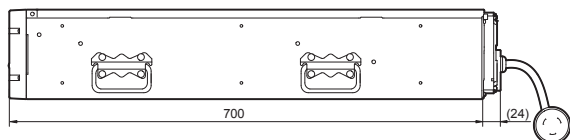
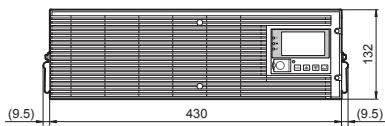
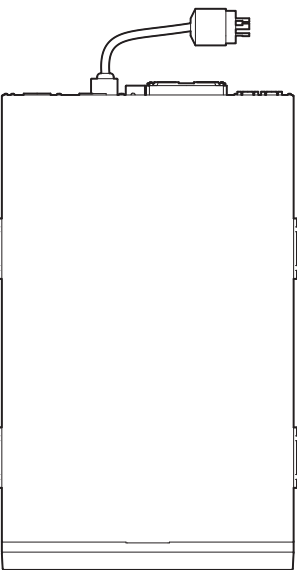

• Upright stand

<Unit: mm/ Tolerance: ± 2 mm for total length, ± 1 mm for other measurements>

<BU2002RWLG/BU3002RWLG>

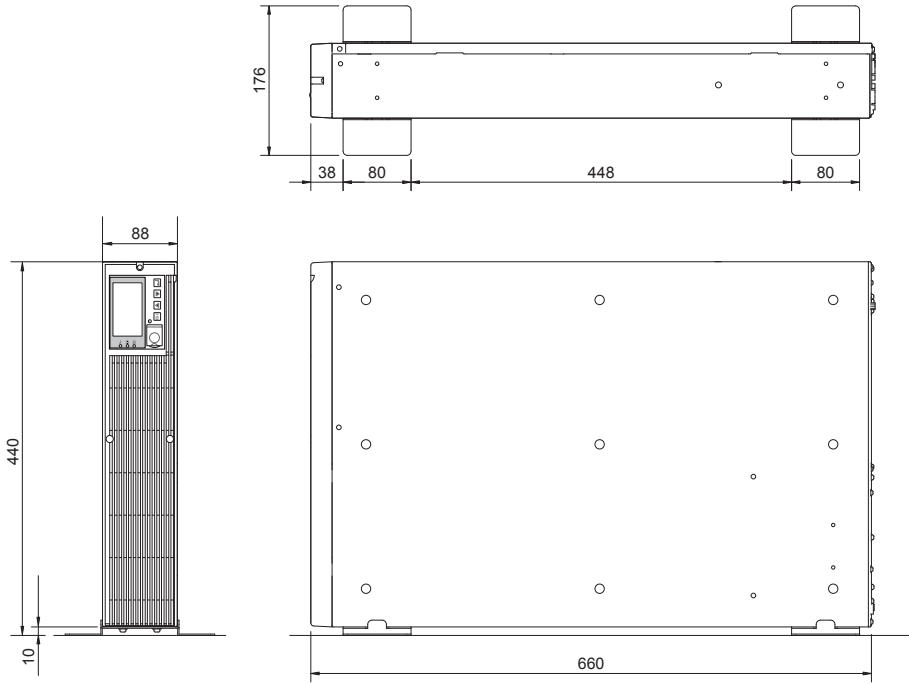

<BU5002RWLG>

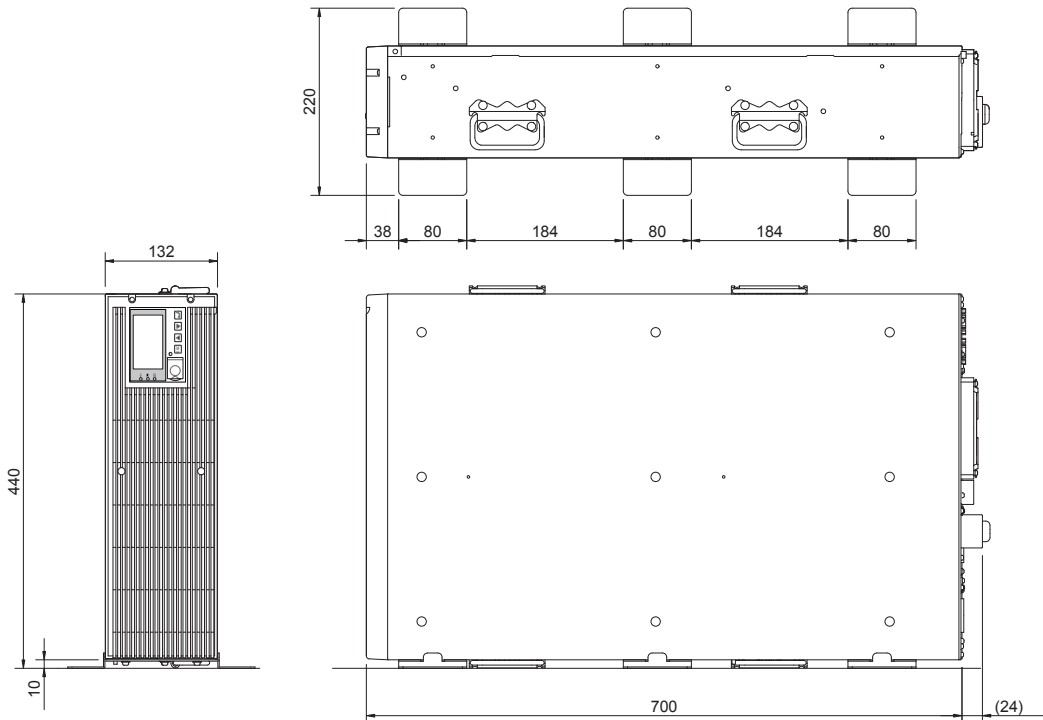

References

- Rubber feet <Unit: mm/ Tolerance: ± 2 mm for total length, ± 1 mm for other measurements>

<BU2002RWLG/BU3002RWLG>

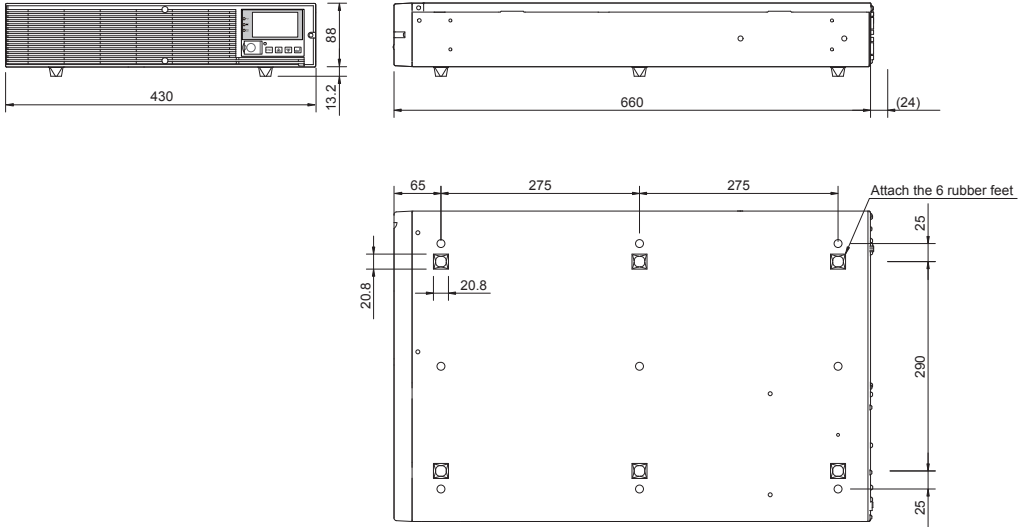

<BU5002RWLG>

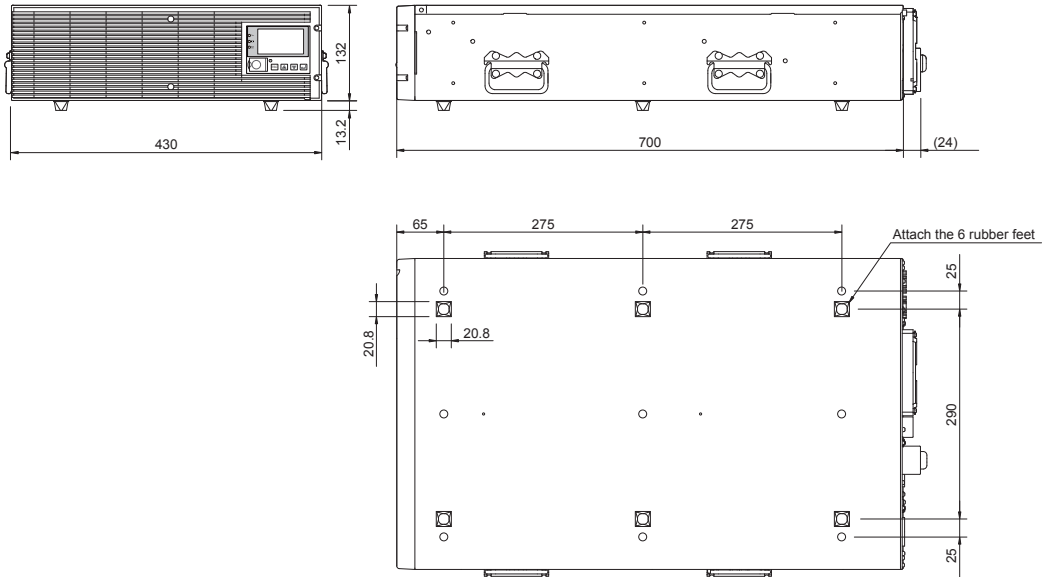

• Support angles <Unit: mm/ Tolerance: ±2mm for total length, ±1mm for other measurements>

Rack rail

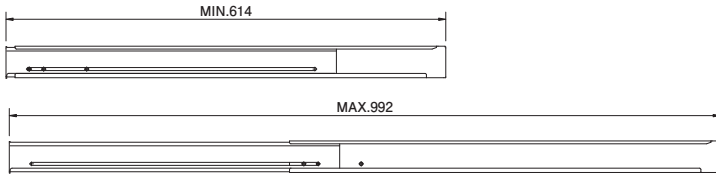

After rackmount installation

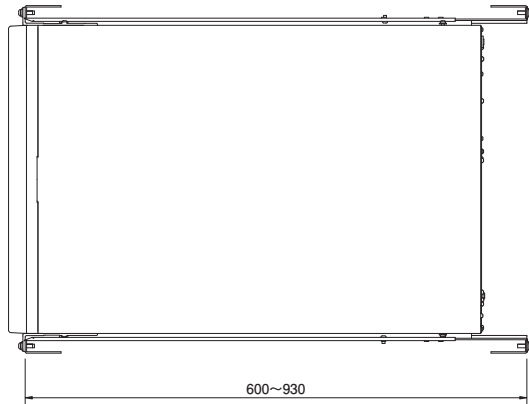

<BU2002RWL/BU3002RWLG>

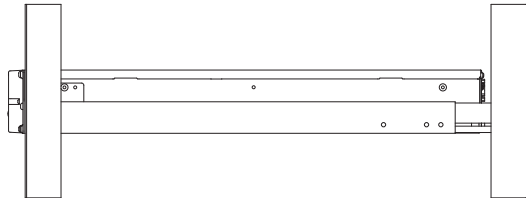
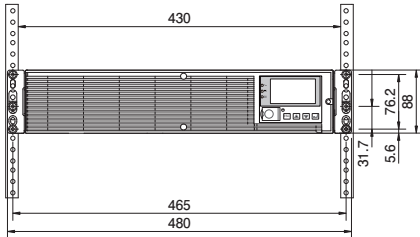

<BU5002RWLG>

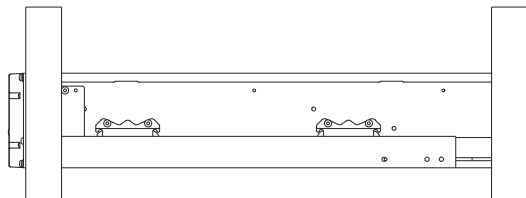
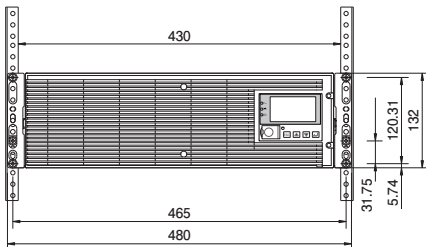

C. Circuit block diagram

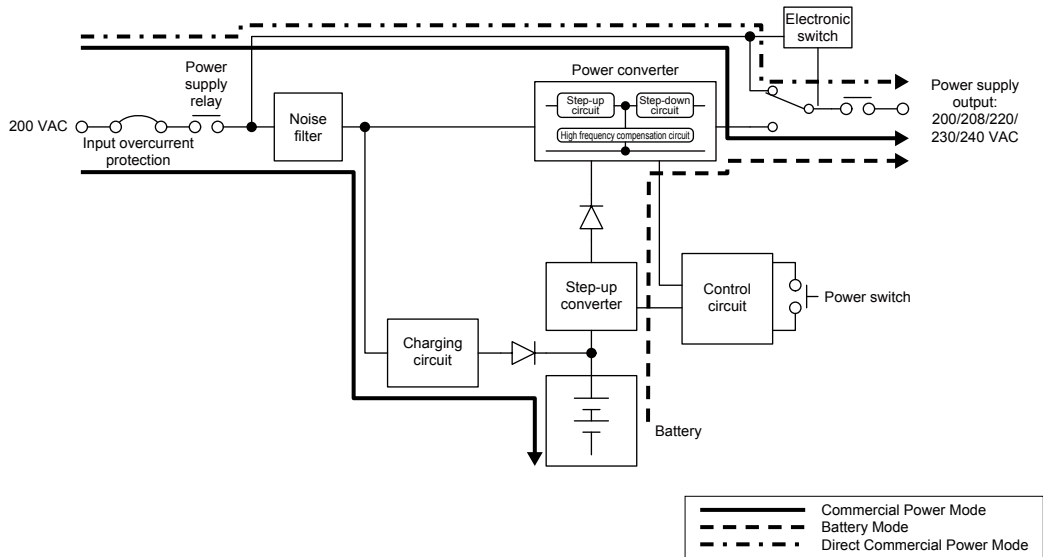

D. Related products

Description	BU2002RWLG	BU3002RWLG	BU5002RWLG
Replacement battery pack	BUB2002RW	BUB3002RW	BUB3002RW (2PCS)
SNMP/Web card	SC20G2		
Contact signal card	SC08G		

*The standard UPS connection signal is NPN.
 To use a PNP connection, please adopt SC08G(option).
 For details, refer to the instruction manual that comes with the SC08G.

Omron representatives

OMRONT EUROPE B.V.

+31 (0) 23 568 13 00
industrial.omron.eu

Austria

Tel: +43 (0) 2236 377 800
industrial.omron.at

Belgium

Tel: +32 (0) 2 466 24 80
industrial.omron.be

Czech Republic

Tel: +420 234 602 602
industrial.omron.cz

Denmark

Tel: +45 43 44 00 11
industrial.omron.dk

Finland

Tel: +358 (0) 207 464 200
industrial.omron.fi

France

Tel: +33 (0) 1 56 63 70 00
industrial.omron.fr

Germany

Tel: +49 (0) 2173 680 00
industrial.omron.de

Hungary

Tel: +36 1 399 30 50
industrial.omron.hu

Italy

Tel: +39 02 326 81
industrial.omron.it

Netherlands

Tel: +31 (0) 23 568 11 00
industrial.omron.nl

Norway

Tel: +47 (0) 22 65 75 00
industrial.omron.no

Poland

Tel: +48 22 458 66 66
industrial.omron.pl

Portugal

Tel: +351 21 942 94 00
industrial.omron.pt

Russia

Tel: +7 495 648 94 50
industrial.omron.ru

South Africa

Tel: +27 (0)11 579 2600
industrial.omron.co.za

Spain

Tel: +34 902 100 221
industrial.omron.es

Sweden

Tel: +46 (0) 8 632 35 00
industrial.omron.se

Switzerland

Tel: +41 (0) 41 748 13 13
industrial.omron.ch

Turkey

Tel: +90 212 467 30 00
industrial.omron.com.tr

United Kingdom

Tel: +44 (0) 1908 258 258
industrial.omron.co.uk

More Omron representatives
industrial.omron.eu



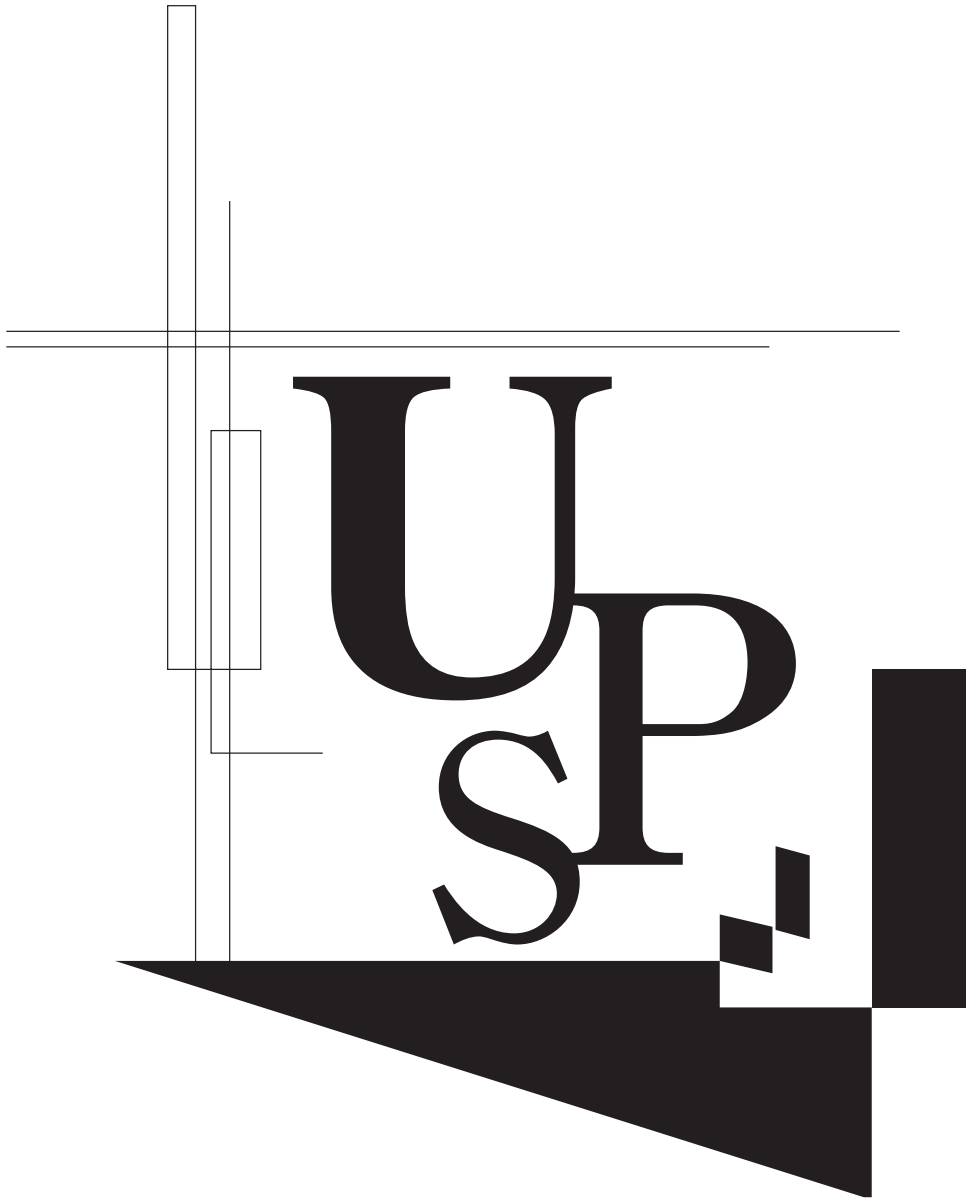

No part or whole of this manual may be reproduced without permission.
The contents of this manual are subject to change without notice.