

OMRON

Smart Camera FQ2-S/CH Series

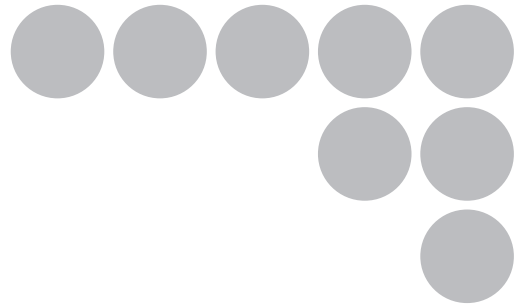

User's Manual



Cat. No. Z337-E1-07

Introduction

Thank you for purchasing the FQ2-S/CH.

This manual provides information regarding functions, performance and operating methods that are required for using the FQ2-S/CH.

When using the FQ2-S/CH, be sure to observe the following:

- The FQ2-S/CH must be operated by personnel knowledgeable in electrical engineering.
- To ensure correct use, please read this manual thoroughly to deepen your understanding of the product.
- Please keep this manual in a safe place so that it can be referred to whenever necessary.

NOTE

- All rights reserved. No part of this publication may be reproduced, stored in a retrieval system, or transmitted, in any form, or by any means, mechanical, electronic, photocopying, recording, or otherwise, without the prior written permission of OMRON.
- No patent liability is assumed with respect to the use of the information contained herein. Moreover, because OMRON is constantly striving to improve its high-quality products, the information contained in this manual is subject to change without notice. Every precaution has been taken in the preparation of this manual. Nevertheless, OMRON assumes no responsibility for errors or omissions. Neither is any liability assumed for damages resulting from the use of the information contained in this publication.

Trademarks

Sysmac and SYSMAC are trademarks or registered trademarks of OMRON Corporation in Japan and other countries for OMRON factory automation products.

- Microsoft, Windows, Windows Vista, Excel, and Visual Basic are either registered trademarks or trademarks of Microsoft Corporation in the United States and other countries.
- Intel, Core and Pentium are trademarks of Intel Corporation in the U.S. and/or other countries.
- ODVA, CIP, CompoNet, DeviceNet, and EtherNet/IP are trademarks of ODVA.
- QR Code is a registered trademark of DENSO WAVE INCORPORATED.
- MELSEC is trademark of Mitsubishi Electric Corporation.

Other company names and product names in this document are the trademarks or registered trademarks of their respective companies.

Copyrights

Microsoft product screen shots reprinted with permission from Microsoft Corporation.

User's Manual

Terms and Conditions Agreement
(Please Read)

Introduction

1

Installation and Connections

2

Taking Images

3

Setting Up Inspections

4

Testing and Saving Settings

5

Operation

6

Convenient Functions

7

Troubleshooting

8

Appendices

9

Terms and Conditions Agreement

Warranty, Limitations of Liability

● Warranties

Exclusive Warranty

Omron's exclusive warranty is that the Products will be free from defects in materials and workmanship for a period of twelve months from the date of sale by Omron (or such other period expressed in writing by Omron). Omron disclaims all other warranties, express or implied.

Limitations

OMRON MAKES NO WARRANTY OR REPRESENTATION, EXPRESS OR IMPLIED, ABOUT NON-INFRINGEMENT, MERCHANTABILITY OR FITNESS FOR A PARTICULAR PURPOSE OF THE PRODUCTS. BUYER ACKNOWLEDGES THAT IT ALONE HAS DETERMINED THAT THE PRODUCTS WILL SUITABLY MEET THE REQUIREMENTS OF THEIR INTENDED USE.

Omron further disclaims all warranties and responsibility of any type for claims or expenses based on infringement by the Products or otherwise of any intellectual property right.

Buyer Remedy

Omron's sole obligation hereunder shall be, at Omron's election, to (i) replace (in the form originally shipped with Buyer responsible for labor charges for removal or replacement thereof) the non-complying Product, (ii) repair the non-complying Product, or (iii) repay or credit Buyer an amount equal to the purchase price of the non-complying Product; provided that in no event shall Omron be responsible for warranty, repair, indemnity or any other claims or expenses regarding the Products unless Omron's analysis confirms that the Products were properly handled, stored, installed and maintained and not subject to contamination, abuse, misuse or inappropriate modification. Return of any Products by Buyer must be approved in writing by Omron before shipment. Omron Companies shall not be liable for the suitability or unsuitability or the results from the use of Products in combination with any electrical or electronic components, circuits, system assemblies or any other materials or substances or environments. Any advice, recommendations or information given orally or in writing, are not to be construed as an amendment or addition to the above warranty.

See <http://www.omron.com/global/> or contact your Omron representative for published information.

● Limitation on Liability; Etc

OMRON COMPANIES SHALL NOT BE LIABLE FOR SPECIAL, INDIRECT, INCIDENTAL, OR CONSEQUENTIAL DAMAGES, LOSS OF PROFITS OR PRODUCTION OR COMMERCIAL LOSS IN ANY WAY CONNECTED WITH THE PRODUCTS, WHETHER SUCH CLAIM IS BASED IN CONTRACT, WARRANTY, NEGLIGENCE OR STRICT LIABILITY.

Further, in no event shall liability of Omron Companies exceed the individual price of the Product on which liability is asserted.

Application Considerations Warranties

Suitability of Use

Omron Companies shall not be responsible for conformity with any standards, codes or regulations which apply to the combination of the Product in the Buyer's application or use of the Product. At Buyer's request, Omron will provide applicable third party certification documents identifying ratings and limitations of use which apply to the Product. This information by itself is not sufficient for a complete determination of the suitability of the Product in combination with the end product, machine, system, or other application or use. Buyer shall be solely responsible for determining appropriateness of the particular Product with respect to Buyer's application, product or system. Buyer shall take application responsibility in all cases.

NEVER USE THE PRODUCT FOR AN APPLICATION INVOLVING SERIOUS RISK TO LIFE OR PROPERTY WITHOUT ENSURING THAT THE SYSTEM AS A WHOLE HAS BEEN DESIGNED TO ADDRESS THE RISKS, AND THAT THE OMRON PRODUCT(S) IS PROPERLY RATED AND INSTALLED FOR THE INTENDED USE WITHIN THE OVERALL EQUIPMENT OR SYSTEM.

Programmable Products

Omron Companies shall not be responsible for the user's programming of a programmable Product, or any consequence thereof.

Disclaimers

Performance Data

Data presented in Omron Company websites, catalogs and other materials is provided as a guide for the user in determining suitability and does not constitute a warranty. It may represent the result of Omron's test conditions, and the user must correlate it to actual application requirements. Actual performance is subject to the Omron's Warranty and Limitations of Liability.

Change in Specifications

Product specifications and accessories may be changed at any time based on improvements and other reasons. It is our practice to change part numbers when published ratings or features are changed, or when significant construction changes are made. However, some specifications of the Product may be changed without any notice. When in doubt, special part numbers may be assigned to fix or establish key specifications for your application. Please consult with your Omron's representative at any time to confirm actual specifications of purchased Product.

Errors and Omissions

Information presented by Omron Companies has been checked and is believed to be accurate; however, no responsibility is assumed for clerical, typographical or proofreading errors or omissions.

Meanings of Signal Words

The following signal words are used in this manual.



Indicates a potentially hazardous situation which, if not avoided, will result in minor or moderate injury, or may result in serious injury or death. Additionally there may be significant property damage.

Meanings of Alert Symbols

The following alert symbols are used in this manual

	Indicates general prohibitions for which there is no specific symbol.
	Indicates the possibility of laser radiation.
	Indicates the possibility of explosion under specific conditions.
	Indicates prohibition when there is a risk of minor injury from electrical shock or other source if the product is disassembled.



This product is not designed or rated for ensuring safety of persons.
Do not use it for such purposes.



The Sensor emits visible light, which may adversely affect the eyes in rare instances.
Do not look directly into the light emitted from the Sensor. When the subject is a specular reflective object, protect your eyes from reflected light.



A lithium ion battery is built into the Touch Finder and may occasionally combust, explode, or burn if not treated properly.
Dispose of the Touch Finder as industrial waste, and never disassemble, apply pressure that would deform, heat to 100 °C or higher, or incinerate the Touch Finder.



High-voltage parts inside; danger of electrical shock. Do not open the product cover.



Precautions for Safe Use

The following points are important to ensure safety, so make sure that they are strictly observed.

1. Installation Environment

- Do not use the product in environments where it can be exposed to inflammable/explosive gas.
- To secure the safety of operation and maintenance, do not install the product close to high-voltage devices and power devices.
- Install the product in such a way that its ventilation holes are not blocked.
- Tighten mounting screws at the torque specified in this manual.

2. Power Supply and Wiring

- The power supply voltage must be within the rated range (24 VDC \pm 10%), and an AC voltage must not be used.
- Reverse connection of the power supply is not allowed. Do not short the load of the open collector output.
- The load must be within the rated range.
- High-voltage lines and power lines must be wired separately from this product. Wiring them together or placing them in the same duct may cause induction, resulting in malfunction or damage.
- Use the products within the power supply voltages specified in this manual.
- Use the specified size of crimp terminals to wire connections. Do not connect wires that have been simply twisted together directly to the power supply or terminal block.
- Use a DC power supply with safety measures against high voltages (safety extra low-voltage circuit).
- Use independent power sources for the products. Do not use a shared power source.
- Tighten mounting screws at the torque specified in this manual.
- Always turn OFF the power supply before connecting or disconnecting cables or the power supply wiring.

3. Battery

- Do not short the positive and negative terminals of the Battery.
- Do not use the Touch Finder in an environment that exceeds the operating temperature range of the Battery. If the Touch Finder is used at temperatures that exceed the operating temperature range, the protective device may activate and prevent charging.
- Do not connect the Battery directly to a power supply or car cigarette lighter socket.
- Do not use the Touch Finder with any other type of battery.
- Turn OFF the power supply immediately if the Battery leaks or produces an odor. Electrolyte leaked from the Battery may ignite, possibly causing smoke, rupture, or fire.
- If during usage, charging, or storage, the Battery produces an odor, heats, becomes discolored, becomes misshapen, or exhibits any other unusual conditions, remove it and do not use it. Continuing to use such a Battery may result in the Battery heating, smoking, rupturing, or igniting.
- If the Touch Finder (FQ2-D31) will be installed permanently or semi-permanently, remove power supplies other than the Battery (FQ-BAT1). If the rated temperature is exceeded with the Battery inserted, the protective circuit may activate and stop the Touch Finder.

4. AC Adapter

- Use an AC cable that is suitable for the power supply and power voltage you are using.
- Do not touch the power plug with a wet hand. Doing so may result in electrical shock.
- If you notice an abnormal condition, such as smoke, abnormal heating of the outer surface, or a strange odor, immediately stop using the AC Adapter, turn OFF the power, and remove the power plug from the outlet.
Consult your dealer, as it is dangerous to attempt to repair the AC Adapter yourself.
- If the AC Adapter is dropped or damaged, turn OFF the power, remove the power plug from the outlet, and contact your dealer. There is a risk of fire if you continue using the AC Adapter.

5. Handling

- Connector Cover

Always attach the connector cover when you disconnect the cable. If you do not attach the connector cover, foreign matter may enter the connection, causing malfunctions or damage.

- Lens Cap

Always attach a C-mount lens cap to the lens mount when you remove the lens. If dust or dirt adhere to the imaging elements, false detection or failure may occur.

- Sensor Waterproof Sheets

Do not remove or damage the waterproof sheets on the sides of the Sensor. Doing so may allow dust, dirt, or water drops to enter the Sensor and damage it.

6. EMC Standard

- EU Directive 2014/30/EU

- EN61326-1

- Electromagnetic environment : Industrial electromagnetic environment(EN/IEC 61326-1 Table 2)

- The following condition is applied to the immunity test of this product: If the level of disturbance of the video is such that characters on the monitor are readable, the test is a pass.

7. Other

- Do not use this product in safety circuits associated with nuclear power and human life.

- Do not disassemble, repair, modify, deform by pressure, or incinerate this product.

- Dispose of this product as industrial waste.

- If you notice an abnormal condition, such as a strange odor, extreme heating of any product, or smoke, immediately stop using the product, turn OFF the power, and consult your dealer.

- The Sensor surfaces become hot during use. Do not touch them.

- Do not drop or subject the products to shock.

- Use the special Sensor (FQ2-S/CH), Touch Finder (FQ2-D), Sensor Data Unit (FQ-SDU), Cables (FQ-WN, FQ-WD, FQ-WU, and FQ-VP), Battery (FQ-BAT1), and AC Adapter (FQ-AC). Using other than the specified products may cause fire, burning, malfunction or failure.

- If the product has a lock mechanism, always make sure it is locked before using the product.

Precautions for Correct Use

Observe the following precautions to prevent failure to operate, malfunctions, or undesirable effects on product performance.

1. Installation Site

Do not install this product in locations subjected to the following conditions:

- Ambient temperature outside the rating
- Rapid temperature fluctuations (causing condensation)
- Relative humidity outside the range of 35 to 85%
- Direct vibration or shock
- Strong ambient light (such as other laser beams, light from arc-welding machines, or ultraviolet light)
- Direct sunlight or near heaters
- Strong magnetic or electric field

Also, do not install this product in locations subjected to the following conditions to ensure its protective performance as described in the specifications:

- Presence of corrosive or flammable gases
- Presence of dust, salt, or iron particles
- Water, oil, or chemical fumes or spray, or mist atmospheres

Installing and Using a Sensor with Built-in Lighting

- The front-panel plate may occasionally become fogged from the inside if the Sensor is used in location with high humidity and the temperature changes drastically.
- Do not install any objects except for the special mounting brackets within the dotted lines in the following figure. The front-panel plate may become fogged from the inside.

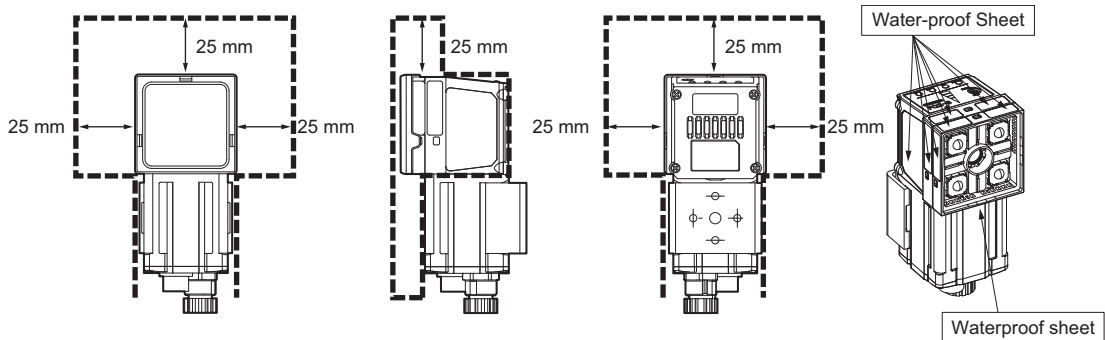

2. Power Supply, Connection, and Wiring

- When using a commercially available switching regulator, make sure that the FG terminal is grounded.
- If surge currents are present in the power lines, connect surge absorbers that suit the operating environment.
- Before turning ON the power after the product is connected, make sure that the power supply voltage is correct, there are no incorrect connections (e.g. load short-circuit) and the load current is appropriate. Incorrect wiring may result in breakdown of the product.
- For cables, use only the special products specified in this manual.
- Do not subject the Cables to twisting stress. Doing so may damage the Cables.
- Always turn OFF the power supply before connecting or disconnecting Cables. The Sensor may fail if a Cable is connected or disconnected while power is being supplied.

 p.569, p.570, p.572

- Use only combinations of the Sensor and Touch Finder specified in this manual. Using other combinations may cause malfunction or damage.
- Do not turn the power OFF in the following instances. Doing so will damage data that is in the process of being saved.

- While data is being saved in internal memory
- While data is being saved on the SD card
- The LCD panel has been made using precision technology, and sometimes a few pixels are missing in the panel. This is due to the structure of the LCD panel, and is not a malfunction.
- Influence of Temperature Changes on Optical Axis
Due to the characteristics of the materials that are used in the Sensor, changes in the ambient temperature may cause the center of the optical axis to change by several pixels.
- Imaging Elements
Due to the specifications of the CMOS image sensors that are used in then Sensor, lines may appear in images for some measurement conditions or gain settings. These do not indicate defects or faults in the Sensor. Also, there may be some pixel defects, but these do not indicate defects or faults in the Sensor.

3. Battery

- Do not use or charge the Battery with other than the specified products.
- Do not charge the Battery with other than the specified AC adapter.
- When using the Touch Finder, the battery cover screw must be tightened.

4. AC Adapter

- During maintenance and when not using the Touch Finder for an extended time, remove the power plug from the outlet.
- Do not bend the power cable past its natural bending radius.
- Do not use the AC Adapter with other than the specified products.
- If a voltage higher than 380 V is applied, there is a risk that the capacitor will be damaged, the pressure valve will open, and vaporized gas will be emitted. If there is a possibility that a voltage higher than 380 V will be applied, use a protective device.

5. Maintenance and Inspection

Do not use thinner, alcohol, benzene, acetone or kerosene to clean the Sensor and Touch Finder. If large dust particles adhere to the Camera, use a blower brush (used to clean camera lenses) to blow them off. Do not use breath from your mouth to blow the dust off. To remove dust particles from the Camera, wipe gently with a soft cloth (for cleaning lenses). Do not use excessive force to wipe off dust particles. Scratches to the Camera might cause error.

Product manuals

The information required to use the FQ2-S/CH Series is divided into two manuals by objective: “FQ2-S/CH Series User’s Manual” and “FQ2-S/CH Series User’s Manual for Communications Settings”. Read each manual as appropriate for your objective.

Manual	Description	Contents
(This manual) FQ2-S/CH Series User's Manual (Cat. No. Z337)	Describes the product specifications, basic settings, and other information required to use the FQ2-S/CH Series.	Product specifications Connections, wiring Camera, image adjustment Inspection item settings Test measurement, operation Troubleshooting
FQ2-S/CH Series User's Manual for Communications Settings (Cat. No. Z338)	Provides information required to operate the sensor by remote control.	System configuration Sensor control method Data input/output specifications Connectable network types Communication settings Output data settings

Editor's Note

■ Meaning of Symbols

Menu items that are displayed on the Touch Finder LCD screen, and windows, dialog boxes and other GUI elements displayed on the PC are indicated enclosed by brackets "[]".

■ Visual Aids

Important

Indicates points that are important to achieve the full product performance, such as operational precautions.

Note

Indicates application procedures.



Indicates pages where related information can be found.

2-2 Par

FQ2-S1 FQ2-S2 FQ2-S3

Shows the models that support the function being described.

FQ2-CH1

FQ2-S1

..... Shows that the FQ2-S1 supports the function.

FQ2-S2

..... Shows that the FQ2-S2 supports the function.

FQ2-S3

..... Shows that the FQ2-S3 supports the function.

FQ2-S4

..... Shows that the FQ2-S4 supports the function.

FQ2-CH

..... Shows that the FQ2-CH supports the function.

MEMO

Contents

Terms and Conditions Agreement	2
Editor's Note	9

1. Introduction

1-1 FQ2-S/CH-series Sensors	22
1-2 Measurement Process	26
1-3 Basic Operational Flow	27
1-4 Startup Display and Display Elements	29
Startup Display	29
Display Elements	30

2. Installation and Connections

2-1 System Configuration	32
2-2 Part Names and Functions	35
2-3 Installation	39
FQ2-S*****/FQ2-CH1*****-M (Sensors with Built-in Lighting)	39
FQ2-S*-*** (Sensors with C-mounts)	41
Installation Precautions	46
Mounting to DIN Track	47
Mounting to a Control Panel	48
Using the Touch Finder as a Portable Device (with Battery)	50
Mounting to DIN Track	51
2-4 Launching the Program for First Time	52
Language settings	52
Time settings	53
2-5 Wiring	54
I/O Signal Circuit Diagrams	55
Power Supply Specifications When a Switching Regulator Is Connected	55
FQ-SDU20/SDU25 RS-232C Pin Signal Names	61
2-6 Setting Up Ethernet	67
Connecting to Sensors from the Touch Finder	67
Connecting to Sensors from External Devices Such as PLCs	68
Connecting to Sensors from a Computer Using the PC Tool	69

3. Taking Images

3-1	Selecting a Sensor for Configuration	74
3-2	Setting Conditions for Taking Images	75
3-3	Adjusting Image Quality	76
	Adjusting the Focus	76
	Adjusting Image Brightness with External Lighting	77
	Adjusting the Brightness	77
	Taking Clear Images of Moving Objects	82
	Improving the Image Quality of Metallic and other Shiny Surfaces	83
	Adjusting the Colors of the Image (White Balance) (Only for Sensors with Color Cameras)	85
	Rotating the Touch Finder Image by 180°	86
3-4	Adjusting the Timing of Taking Images	87
	Delaying the Image Capture Timing from the Trigger Input	87
	Adjusting External Lighting Timing	89
	Preventing Mutual Interference of Multiple Sensors	89
3-5	Adjusting the Images That Were Taken	91
	Image Adjustment	91
	Filtering the Images (Filter Items)	93
	Compensating for Position Offset (Position Compensation Items)	102

4. Setting Up Inspections

4-1	Inspection Item Selection Guide	134
4-2	Setup Procedure for Inspection Items	137
4-3	Configuring Inspection Items	138
	Adding New Inspection Items	138
	Modifying Existing Inspection Items	139
	Deleting Inspection Items	139
4-4	Reading with OCR	140
	Character String Recognition	140
	Characters That Can Be Recognized	140
	Setup Procedure for Character Recognition	141
	Setup Procedure for Character Recognition	141
	Setting the Measurement Parameters	156
	Limiting Readable Characters	158
	Changing the Output Code for Errors (Default: NG)	158
	Troubleshooting Unstable Read Results	158
	When reading a variable length string	158
	Setting Date Parameter	159
	Confirm the Code Data Name	166
	Set or Acquire the Date and Time	167
	Confirm the Date and Time information	168

Perform OCR with creating dictionary (Model dictionary)	168
Creating Model Dictionaries to Recognize Custom Characters	169
Setup Procedure for Model Dictionary	170
Outputting Read Characters to an External Device	176
Measurement Data That Can Be Used for External Outputs and Calculations . . .	177
Measurement Data That Can Be Logged for OCR	178
4-5 Reading Barcodes	179
Bar Codes	179
Setup Procedure for Bar Code	180
Reflect in Total Judgment	185
Detail Settings	186
Changing the Character String That Is Output for Read Errors	187
Changing the Items That Are Displayed on the Test Measurement and Run Display	187
Unstable Reading Results	187
Outputting Read Characters to an External Device	188
Measurement Data That Can Be Used for External Outputs and Calculations . . .	188
Measurement Data That Can Be Logged (Bar Code)	189
Errors	189
4-6 Reading 2D-codes	190
2D-codes	190
Setup Procedure for 2D-code	191
Reflect in Total Judgment	196
Detail Settings	196
Outputting Read Characters to an External Device	197
Changing the Character String That Is Output for Read Errors	198
Unstable Reading Results	199
Measurement Data That Can Be Used for External Outputs and Calculations . . .	199
Measurement Data That Can Be Logged (2D Code)	200
Errors	200
4-7 Reading 2D Codes (DPM)	201
2D Codes (DPM)	201
Setup Procedure for 2D-code (DPM)	202
Detailed Parameters	210
Outputting Read Characters to an External Device	212
Changing the Character String That Is Output for Read Errors	212
Measurement Data That Can Be Used for External Outputs and Calculations . . .	213
Inspection Data that Can be Logged	214
If an Error Occurs	214

4-8 Inspecting with the Search Inspection Item	215
Search Inspection Item	215
Setup Procedure for the Search Inspection Item	216
Increasing Measurement Position Accuracy	219
Obtaining Multiple Results Simultaneously	220
Select the Results to Output	221
Reflect in Total Judgment	222
Unstable Search Results	222
Increasing Processing Speed	224
Editing the Model and Measurement Regions	224
Errors	229
4-9 Inspecting with the Shape Search III Inspection Item	230
Shape Search II Inspection Item	230
Setup Procedure for the Shape Search III Inspection Item	231
Obtaining Multiple Results Simultaneously	235
Select the Results to Output	237
Reflect in Total Judgment	238
Unstable Shape Search III Results	238
Increasing Processing Speed	243
Judgment is NG (Insufficient memory)	243
Editing the Model Regions and Measurement Region	244
Measurement Data That Can Be Used for External Outputs and Calculations	245
Measurement Data That Can Be Logged	246
Errors	246
4-10 Inspecting with the Shape Search II Inspection Item	247
Shape Search II Inspection Item	247
Setup Procedure for the Shape Search II Inspection Item	248
Obtaining Multiple Results Simultaneously	251
Select the Results to Output	252
Reflect in Total Judgment	253
Unstable Shape Search II Results	253
Increasing Processing Speed	255
Editing the Model Regions and Measurement Region	256
Errors	258
4-11 Inspecting with the Sensitive Search Inspection Item	259
Sensitive Search Inspection Item	259
Setup Procedure for the Sensitive Search Inspection Item	260
Reflect in Total Judgment	263
Increasing Measurement Position Accuracy	264
Select the Results to Output	264
Changing the Number Region Divisions	265
Inspecting Plain Regions	265
Unstable Search Results	266
Increasing Processing Speed	267
Editing the Model Regions and Measurement Region	268
Errors	270

4-12 Inspecting with the Edge Position Inspection Item	271
Edge Position	271
Setup Procedure for Edge Position	272
Reflect in Total Judgment	275
Changing Edge Detection Conditions (Sensors with Monochrome Cameras Only)	275
Unstable Edge Position Results	276
Increasing Processing Speed for Edge Position	279
Measurement Data That Can Be Used for External Outputs and Calculations ..	280
Measurement Data That Can Be Logged for Edge Position	281
Errors	281
4-13 Inspecting with the Edge Width Inspection Item	282
Edge Width Inspection Item	282
Setup Procedure for Edge Width Inspection Item	282
Changing Edge Detection Conditions (Sensors with Monochrome Cameras Only)	285
Reflect in Total Judgment	285
Unstable Edge Width Results (Sensors with Color Cameras)	285
Increasing Edge Width Processing Speed	285
Measurement Data That Can Be Used for External Outputs and Calculations ..	286
Measurement Data That Can Be Logged for Edge Width	286
Errors	287
4-14 Inspecting with the Edge Pitch Inspection Item	288
Edge Pitch Inspection Item	288
Setup Procedure for Edge Width Inspection Item	288
Changing Edge Detection Conditions (Sensors with Monochrome Cameras Only)	290
Reflect in Total Judgment	290
Unstable Edge Pitch Results (Sensors with Color Cameras Only)	291
Increasing Edge Pitch Processing Speed	291
Measurement Data That Can Be Used for External Outputs and Calculations ..	291
Measurement Data That Can Be Logged for Edge Pitch	292
Errors	292
4-15 Inspecting with Color Data Inspection Item	293
Color Data Inspection Item	293
Setup Procedure for Color Data Inspection Item	294
Reflect in Total Judgment	297
Measurement Data That Can Be Used for External Outputs and Calculations ..	298
Measurement Data That Can Be Logged (Color Data)	299
Increasing Processing Speed for Color Data	299

4-16 Inspecting with the Area Inspection Item	300
Area Inspection Item	300
Setup Procedure for Area	301
Reflect in Total Judgment	304
Unstable Area Results	304
Increasing Processing Speed for Area	308
Measurement Data That Can Be Used for External Outputs and Calculations ...	309
Measurement Data That Can Be Logged for Area	309
4-17 Inspecting with the Labeling Inspection Item	310
Labeling	310
Setup Procedure for Labeling Inspection Item	311
Unstable Labeling Results	314
Changing the Label Detection Conditions	317
Changing the Label Extraction Conditions	318
Sorting Extracted Labels	319
Reflect in Total Judgement	319
Editing the Measurement Region	320
Increasing the Processing Speed	320
Measurement Data That Can Be Used for External Outputs and Calculations ...	321
Measurement Data That Can Be Logged for Labeling	322
4-18 Calculations and Judgments Using Inspection Item Data	323
Calculation	323
Examples for Calculation	325
Procedure (Calculation)	326
Function List	329

5. Testing and Saving Settings

5-1 Performing Test Measurements	340
Performing Test Measurements with Samples	340
Performing Test Measurements with Saved Images (Re-measuring)	341
5-2 Shortening the Measurement Takt Time	342
Checking the Measurement Takt Time	342
Increasing Image Input Speed	343
Changing the Image Input Mode	345
5-3 Adjusting the Judgment Parameters	346
Adjusting Judgment Parameters While Looking at Measurement Results ...	346
Setting Up the Best Judgement Parameters Automatically	347
5-4 Checking a List of All Inspection Item Results	349
5-5 Saving Data to the Sensor	350

6. Operation

6-1 Starting Operation	352
Run Mode Display	352
Moving to Run Mode	353
6-2 Configuring the Run Mode Display	354
6-3 Checking the Trend of Measurement Results with Graphs	358
Trend Monitor	358
Histograms	360
6-4 Adjusting Judgement Parameters during Operation	362
Preparations	362
Changing the Judgment Parameters in Run Mode	362
6-5 Editing the Model Region / Measurement Region from Run Mode ...	363
Preparations	363
Editing the Model Region from Run Mode	363

7. Convenient Functions

7-1 Changing the Scene to Change the Line Process	366
What Are Scenes?	366
Creating New Scenes	367
Changing Scene Names, Copying Scenes, and Deleting Scenes	367
Switching Scenes from an External Device	368
Setting the Startup Scene	368
7-2 Calibration	369
Calibration	369
Setting the Calibration Pattern	371
Selecting the Calibration Pattern to Use	379
7-3 Display Functions	380
Image Zoom	380
Displaying a Live Image	380
Displaying a Frozen Image	381
Displaying a Saved Image	382
Updating the Display and Measurement Results Only for NG Measurement Results	383
Automatically Changing to the Display for Any Sensor with an NG Result ...	384
Hiding the Menu	384
Turning ON/OFF the Touch Finder Backlight	384
Changing the Brightness of the Touch Finder	384
7-4 Monitoring the Signal I/O Status	385
7-5 Connecting to More Than One Sensor	386
Setting the Sensors to Connect	386
Selecting the Display When More Than One Sensor Is Connected	389

7-6 Logging Measurement Data and Image Data	392
Logging Procedure	393
Logging All Data (File Logging)	394
Checking Recent Measurement Trends (Recent Results Logging)	401
7-7 Saving Sensor Settings	406
Backing Up Settings in External Memory	406
Restoring Data to the Sensor from External Memory	408
7-8 SD Card Operations	409
Inserting and Removing SD Cards	410
Checking the Available Space on the SD Card	411
Formatting an SD Card	412
7-9 Convenient Functions for Operation	413
Setting a Password to Prevent Unwanted Changes	413
Capturing the Displayed Image	415
Saving the Currently Displayed Camera Image	416
Setting the Startup Run Display Pattern	416
Specifying the Sensors to Connect Continuously	417
Monitoring and Setting Up a Sensor from Two Touch Finders	417
Checking the cause of a sensor NG from the multisensor display	419
7-10 Convenient Functions for Setup	420
Making Settings with Stored Images	420
7-11 Setting the Retry Function	422
Retry Function	422
7-12 Functions Related to the System	427
Turning OFF the Integrated Sensor Lighting (Only Sensors with Built-in Lighting)	427
Switching the Display Language	427
Setting the Time on the TouchFinder	427
Setting the Day and Time Information	427
Initializing the Sensor and Touch Finder	428
Restarting the Sensor and Touch Finder	428
Checking Versions	428
Checking the Touch Finder Battery Level	428
Changing the Sensor Name	429
Checking Available Memory in the Sensor	429
Correcting the Touch Screen Positions of the Touch Finder	429
Setting the Resolution of Measurement Objects Displayed on the PC Tool	429
Changing the Sensor's BUSY Indicator	429
Setting the Inspection Timeout Time (FQ2-S4 series or FQ2-CH series only)	429

8. Troubleshooting

8-1 Error Histories	432
8-2 Error Messages	434
8-3 Basic Troubleshooting	435
Restoring a Sensor Connection	436

9. Appendices

9-1 Menu Tables	438
Image Tab Page	438
Inspect Tab Page	443
In/Out Tab Page	461
Test Tab Page	465
Run Tab Page (from Setup Display)	466
Tool	466
Common Menu Commands	476
9-2 External Reference Parameters	477
Color Gray Filter (Color type only)	477
Weak Smoothing	478
Strong Smoothing	478
Dilate	478
Erosion, Median, Extract Edges, Extract Horizontal Edges, Extract Vertical Edges, Enhance edges	479
Background Suppression	479
Shape Search II (FQ2-S1/S2/S3 series or FQ2-S4 series only)	480
Shape Search III Position Compensation (FQ2-S1/S2/S3 series or FQ2-S4 series only)	483
Shape Search Position Compensation	486
Search Position Compensation	489
Edge Position Compensation	490
Two-edge Position Compensation	492
Two-edge Midpoint Compensation	495
Edge Rotation Position Compensation	498
Position Compensation (Image Rotation, Parameter)	501
Linear Correction	502
OCR (FQ2-S4 or FQ2-CH series only)	502
Bar code (FQ2-S4 series only)	513
2D-code (FQ2-S4 series only)	515
2D Codes (DPM) (FQ2-S4 series only)	519
Search (FQ2-S1/S2/S3 series or FQ2-S4 series only)	524
Sensitive Search (FQ2-S1/S2/S3 series or FQ2-S4 series only)	526
Shape Search II (FQ2-S1/S2/S3 series or FQ2-S4 series only)	529
Shape Search III (FQ2-S1/S2/S3 series or FQ2-S4 series only)	531
Edge Position (FQ2-S1/S2/S3 series or FQ2-S4 series only)	534
Edge Width (FQ2-S1/S2/S3 series or FQ2-S4 series only)	536
Edge Pitch (FQ2-S1/S2/S3 series or FQ2-S4 series only)	537
Area (FQ2-S1/S2/S3 series or FQ2-S4 series only)	539
Color Data (FQ2-S1/S2/S3 series or FQ2-S4 series only)	541
Labeling (FQ2-S1/S2/S3 series or FQ2-S4 series only)	543

9-3 Specifications and Dimensions	546
Sensor	546
Touch Finder	560
Sensor Data Units	564
System Requirements for PC Tool for FQ	567
Options	567
9-4 Updating the Software	573
Step 1 Update the software for the PC Tool or Touch Finder.	573
Step 2 Update the software for the Sensor.	573
9-5 Connecting a Previous Touch Finder (FQ-D30/D31) to the FQ2-S Sensor	574
Index	580
Revision History	586

Introduction

1-1 FQ2-S/CH-series Sensors	22
1-2 Measurement Process	26
1-3 Basic Operational Flow	27
1-4 Startup Display and Display Elements	29

1-1 FQ2-S/CH-series Sensors

FQ2-S1

FQ2-S2

FQ2-S3

FQ2-S4

FQ2-CH

Overview of FQ2-S/CH Series

The FQ2-S/CH Series features Sensors with integrated cameras and controllers. They can be used to easily achieve simple inspections^{*1} and measurements^{*1} and to easily read and verify IDs^{*2}.

You can use parallel controls, no-protocol communications on Ethernet, PLC Link communications on Ethernet, and EtherNet/IP communications on Ethernet as standard features. You can also use a Sensor Data Unit to enable control with full-scale parallel communications or RS-232C communications.

To set up and monitor the Sensor, you can use either the Touch Finder or the dedicated setting tool, TouchFinder for PC (hereinafter also referred to as PC Tool). For actual operation, you can use the Sensor on a stand-alone basis.

*1: FQ2-S1/S2/S3/S4 series only

*2: FQ2-S4/CH series only

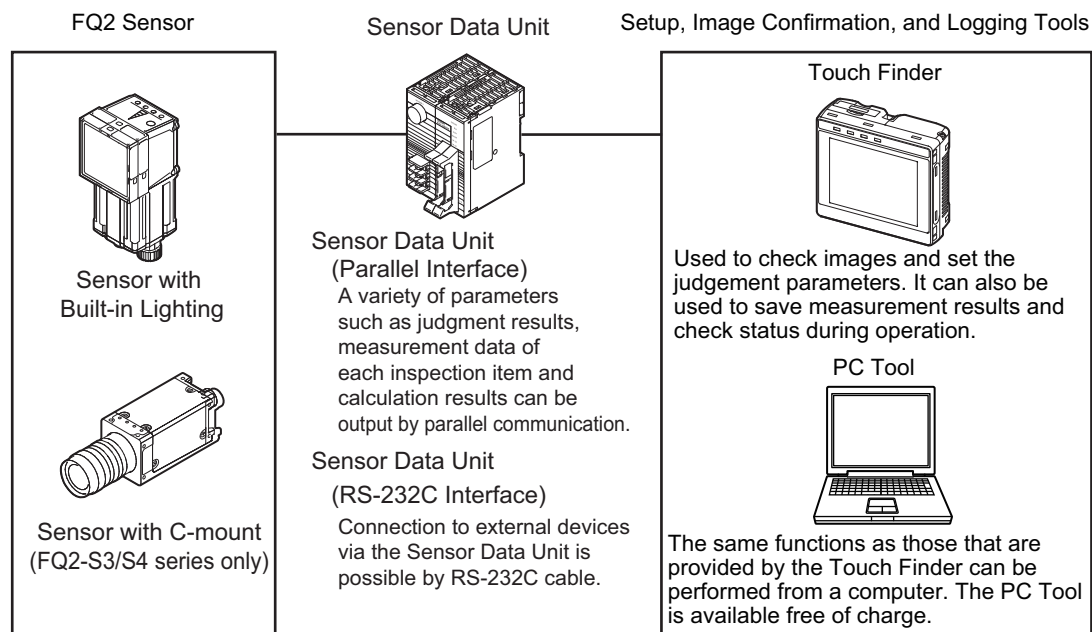

After the Sensor has been set up, it can be operated alone to perform measurements without the Touch Finder or PC Tool.

Note

Sensor Simulation function in TouchFinder for PC version.2.00 or later.

FQ2-S/CH Series types

The FQ2-S Series sensor comes in a C-mount type that allows you to change the lens, and an integrated lighting type with built-in lighting. The FQ2-S/CH Series consists of the following lineup.

• FQ2-S1/S2/S3 Series

A standard full-function type to an easy-to-use single-functional type are available.

Models	Single-function	Standard	High-resolution	
Type	Sensors with Built-in Lighting			Sensors with C-mounts
Model number	FQ2-S1□□□□□□	FQ2-S2□□□□□□-M	FQ2-S3□□□□□□-08	FQ2-S3□-13□
Number of simultaneous measurements	1	32		
Number of registered scenes	8	32		
Partial input	Horizontally only		Horizontally and vertically	
Lens mount	---			C-mount
Image processing method	Real color		Real color or monochrome (Model numbers for Monochrome Sensors end in "M.")	
Connection to Sensor Data Unit	Not possible.		Possible.	
Processing resolution	752 × 480		928 × 828	1,280 × 1,024

• **FQ2-S4 Series**

A standard type (350,000 pixels) to high-resolution types with substantially increased resolution (760,000 pixel type and 1.3 million pixel type) are available.

Pixels	350,000		760,000		1,300,000	
Type	Sensors with Built-in Lighting				Sensors with C-mounts	
Model	FQ2-S4□□□□□	FQ2-S4□□□□□-M	FQ2-S4□□□□□-08	FQ2-S4□□□□□-08	FQ2-S4□-13	FQ2-S4□-13M
Number of simultaneous measurements	32					
Number of registered scenes	32					
Partial input	Horizontally only		Horizontally and vertically			
Lens mount	---				C-mount	
Image processing method	Real color	Monochrome	Real color	Monochrome	Real color	Monochrome
Connection to Sensor Data Unit	Possible.					
Processing resolution	752 × 480		928 × 828		1,280 × 1,024	

• **FQ2-CH Series**

This model is specialized for ID verification and reading.

Models	Single-function
Type	Sensors with Built-in Lighting
Model	FQ2-CH10□□□□-M, FQ2-CH15□□□□-M
Number of simultaneous measurements	32
Number of registered scenes	32
Partial input	Horizontally only
Lens mount	---
Image processing method	Monochrome
Connection to Sensor Data Unit	Possible.
Processing resolution	752 × 480

• Comparison of functions by FQ2 Series model

○: Yes, ×: No

Function		Model			
		FQ2-S1/S2	FQ2-S3	FQ2-S4	FQ2-CH
Inspection item	OCR	×	×	○	○
	Bar code	×	×	○	×
	2D-code	×	×	○	×
	2D-code (DPM)	×	×	○	×
	Search	○	○	○	×
	Sensitive Search	○	○	○	×
	Shape Search II	○	○	○	×
	Shape Search III	○	○	○	×
	Edge Position	○	○	○	×
	Edge Width	○	○	○	×
	Edge Pitch	○	○	○	×
	Area	○	○	○	×
	Color Data	○	○	○	×
	Labeling	○	○	○	×
Main functions	Partial input function	Horizontal only	Both horizontal and vertical	Both horizontal and vertical	Horizontal only
	Retry Function	×	×	○	○
	I/O expansion	×	○	○	○
	RS-232C	×	○	○	○

1-2 Measurement Process

FQ2-S1

FQ2-S2

FQ2-S3

FQ2-S4

FQ2-CH

This section describes the basic flow of the measurement process.

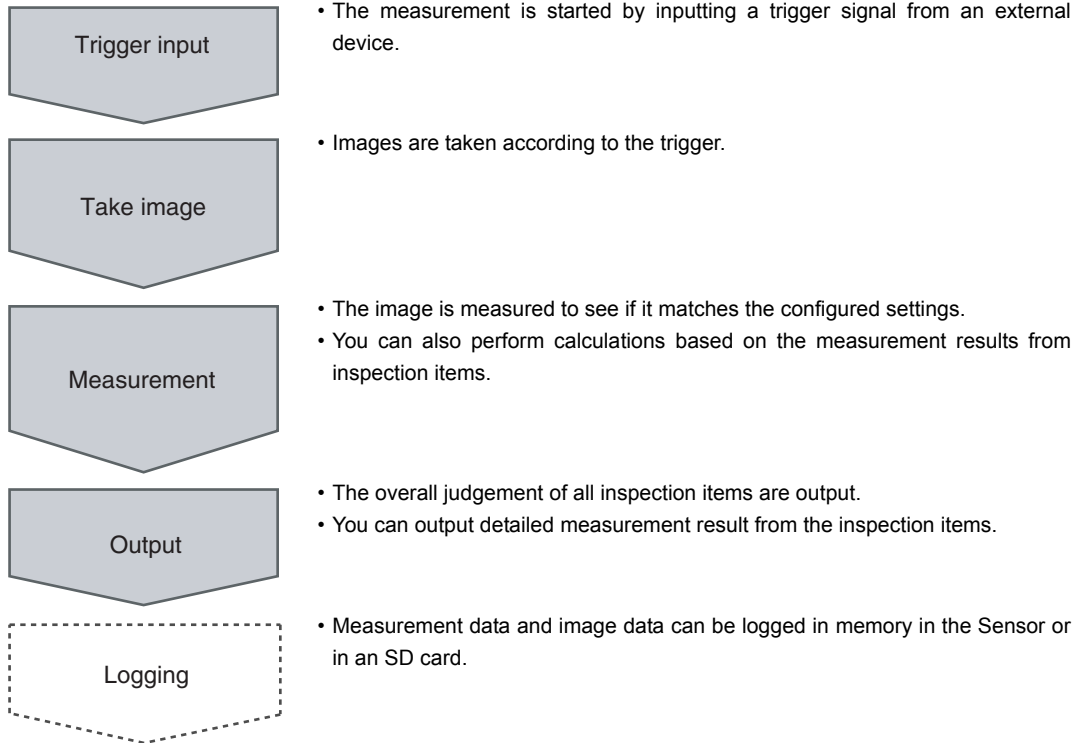

1-3 Basic Operational Flow

FQ2-S1

FQ2-S2

FQ2-S3

FQ2-S4

FQ2-CH

The following flow shows the basic operation of FQ2-S/CH-series Sensors.

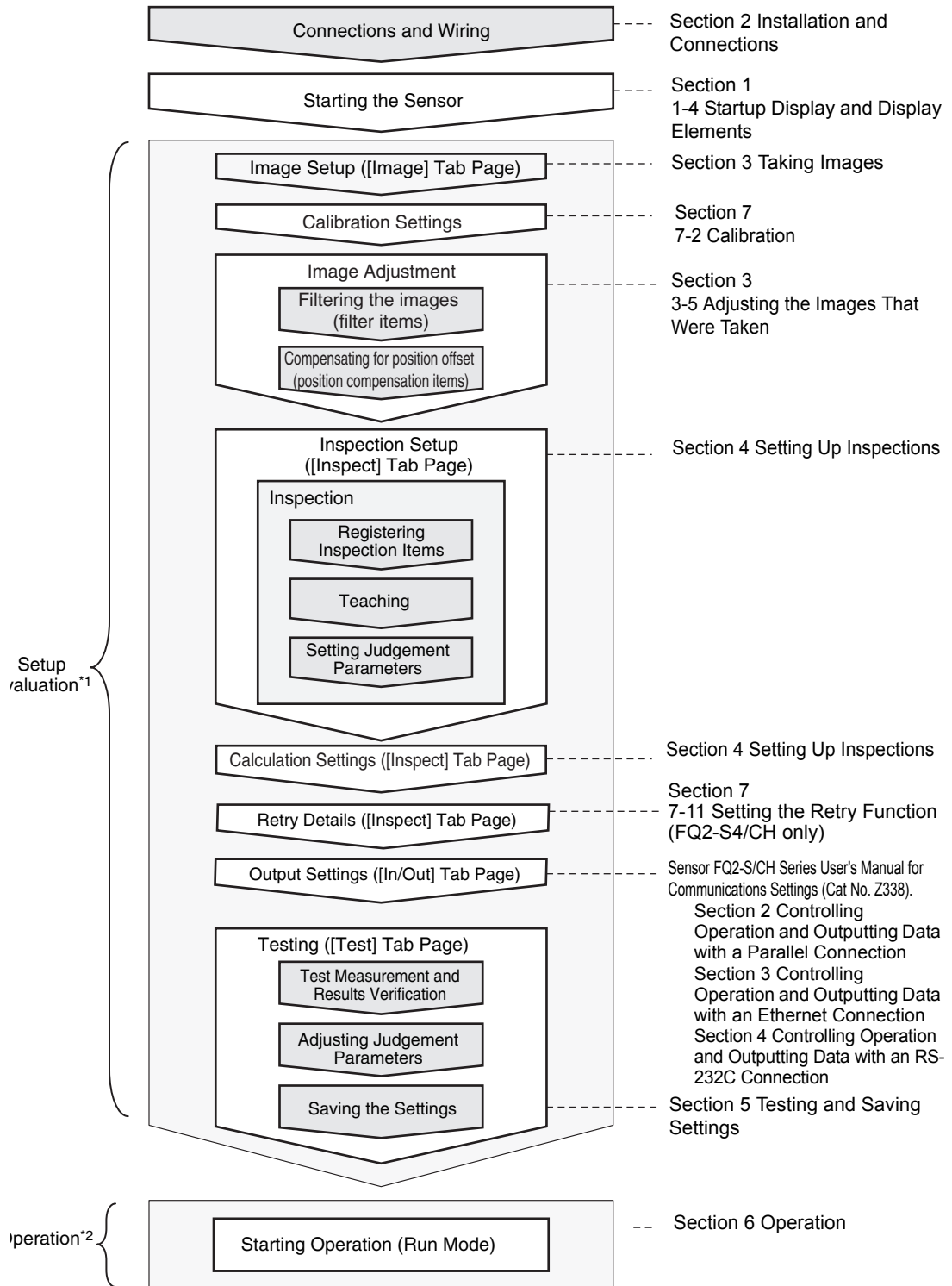

*1: In Setup Mode, the Sensor can be set up and adjusted, but it does not output signals on the I/O lines.
 *2: In Run Mode, the Sensor performs measurements and outputs signals on the I/O lines.

Note

Even when a Touch Finder is not connected, you can monitor parallel I/O signals and control output states using only communication commands.

The following commands are used for this purpose:

- Run Mode settings
- Terminal information get/set commands

For details on each command, refer to the following.

 *FQ2-S/CH Series User's Manual for Communications Settings (Cat. No. Z338)*
5-1 Command Control

1-4 Startup Display and Display Elements

FQ2-S1

FQ2-S2

FQ2-S3

FQ2-S4

FQ2-CH

Startup Display

- 1** When the Sensor and Touch Finder are powered on, the language selection display appears and then the Sensor List.

Select the Sensor you want to connect, and press [OK].

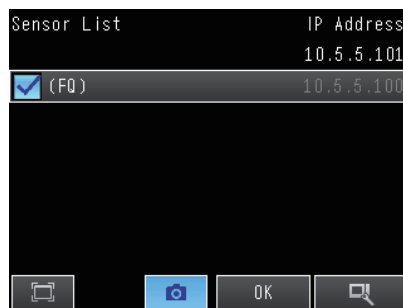

- 2** Sensor connection processing takes place.

- 3** If the Sensor is not detected, press the [Sensor List] button to move to the Sensor List, and check the connection settings.

 *Selecting the Sensors to Connect: p.388*

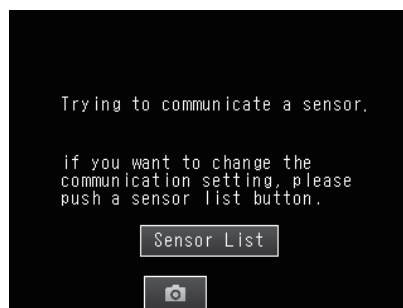

Note

Touch Finder [DHCP] setting is OFF. In the following cases, the Sensor List will not appear. The screen of Step 4 is displayed immediately after you turn on the power.

- The Sensor to be connected is already set
- "Auto sensor detection" is set to ON
- "Specify sensor" is set to ON

4 When the Sensor is detected, the following display will appear.

- The Setup Mode will appear if a Sensor that has not been set up is connected.



- The Run Mode will appear if a Sensor that has been set up is connected.



Note

When the Touch Finder is started, IP addresses are automatically set for each Sensor. To allocate specific IP addresses, set the IP address of each Sensor and the Touch Finder.

 2-6 *Setting Up Ethernet: p.67*

Display Elements

This Sensor has a Setup Mode and a Run Mode.

Refer to  9-1 *Menu Tables: p. 438*

Installation and Connections

2-1 System Configuration	32
2-2 Part Names and Functions	35
2-3 Installation	39
2-4 Launching the Program for First Time	52
2-5 Wiring	54
2-6 Setting Up Ethernet	67

2-1 System Configuration

FQ2-S1

FQ2-S2

FQ2-S3

FQ2-S4

FQ2-CH

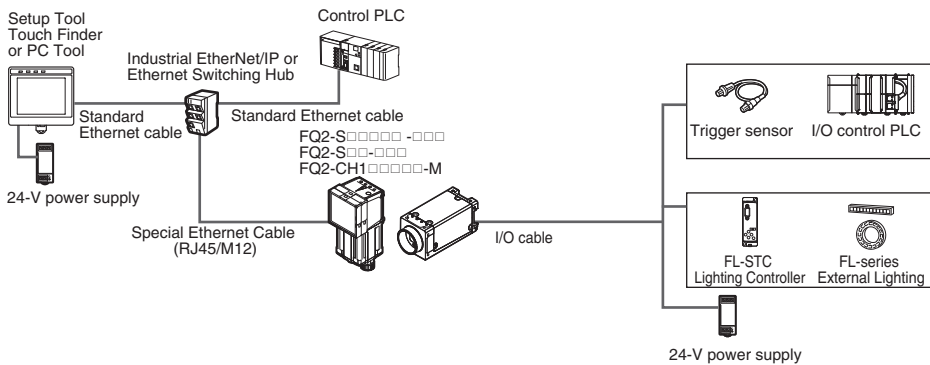

Parallel Interface Connection

Connection through a Parallel Interface Sensor Data Unit

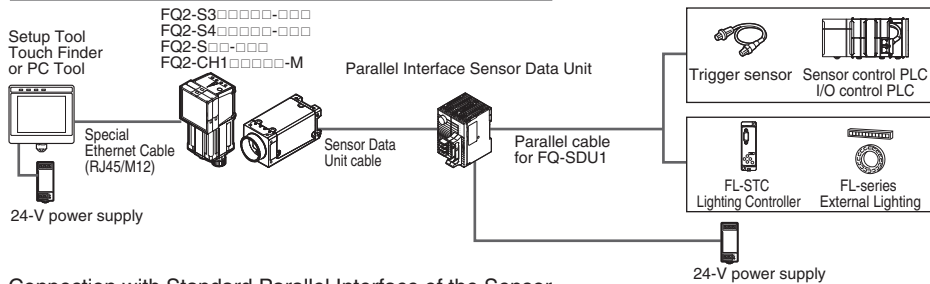

Connection with Standard Parallel Interface of the Sensor

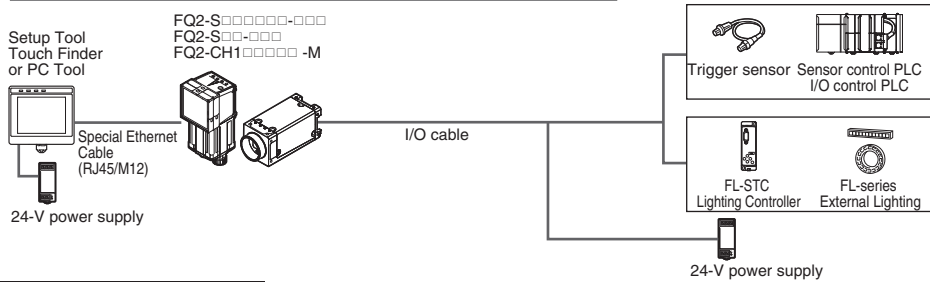

RS-232C Serial Connection

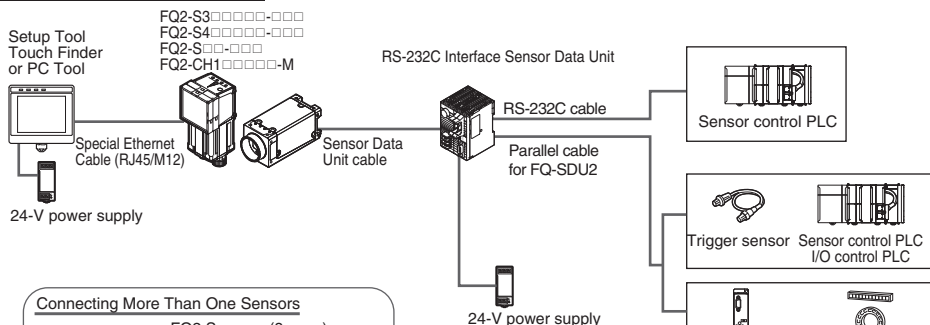

Connecting More Than One Sensors

FQ2 Sensors (8 max.)

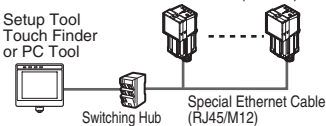

The Setup Tool can detect up to 32 Sensors and it can connect to up to eight Sensors at the same time. A combined total of two Touch Finder / PC Tool units can be connected on the same network.

Product	Model number	Remarks
FQ Sensor	FQ2-S□□□□□□-□□□ FQ2-S□□-□□□ FQ2-CH1□□□□□M	This is the Sensor.
Touch Finder	FQ2-D□□	This is a setup console.
PC Tool	---	The PC Tool can be used instead of the Touch Finder. If you register as a member, you can download the free PC Tool as a special service to purchasers. Refer to the <i>Member Registration Sheet</i> that is enclosed with the Sensor for the member registration procedure and the download procedure for special member software.
Parallel Interface Sensor Data Unit* ¹	FQ-SDU1□	You can connect a Sensor Data Unit to the I/O cable connector on the Sensor and connect the Parallel Interface Sensor Data Unit to an external device. This allows you to output the results of judgment conditions, measurements from inspection items, and the results of expressions with parallel communications.
RS-232C Interface Sensor Data Unit* ¹	FQ-SDU2□	You can connect a Sensor Data Unit to the I/O cable connector on the Sensor and connect the RS-232C Interface Sensor Data Unit to an external device. This allows you to use no-protocol communications to send and receive commands, inspection item parameters, and other data between the Sensor and the external control device that is connected with the RS-232C cable. You can also use the ACK signal (parallel command normal completion signal) for a parallel output from the Sensor Data Unit.
FQ Ethernet Cable	FQ-WN0□□-	Connects the Sensors to external devices such as the Touch Finder, computers, and PLCs.
Standard RJ45 Ethernet Cable* ²	---	Connects the Switching Hub to the Touch Finder, computers, and PLCs. Use a connector that complies with the FCC RJ45 standard. (STP (shielded twisted-pair) cable, category 5e or 6, impedance: 100 Ω)
I/O Cable	FQ-WD0□□-	Connects the Sensor to the power supply and external devices.
Switching Hub	W4S1-0□□-	Used to connect multiple Sensors to one Touch Finder or PC Tool.
Sensor Data Unit cable	FQ-WU0□□-	This cable connects the FQ2-S3/S4/CH Sensor to the Sensor Data Unit.
Parallel cable for FQ-SDU1	FQ-VP1□□□-	This cable connects the Parallel Interface Sensor Data Unit to an external device.
Parallel cable for FQ-SDU2	FQ-VP2□□□-	This cable connects the RS-232C Interface Sensor Data Unit to an external device.
RS-232C cable (to connect to a PLC)	Recommended: XW2Z-200S-V (2 m) or XW2Z-500S-V (5 m)	This cable connects the RS-232C Interface Sensor Data Unit to an external device.

*1: FQ2-S1□□□□□□ and FQ2-S2□□□□□□ are not supported.

*2: The shape and dimensions of the Ethernet connector plug and jack are specified in ISO/IEC8877:1992 (JIS X 5110:1996) and RJ-45 of the FCC regulations. To prevent connector connection failures, the structure of the jack of this product does not allow insertion of plugs that do not comply with the standard. If a commercially available plug cannot be inserted, it is likely that the plug is non-compliant.

Important

Do not connect network devices other than PLCs on the same network as the Touch Finder or computer. If another device is connected, the responsiveness of displays and settings of the Touch Finder or computer may become slow.

Connection Compatibility

Yes: Supported, No: Not supported

Type of connection to FQ2-S/CH		Other connection								
		EtherNet/IP	PLC Link on Ethernet	PROFINET	TCP no-protocol communications on Ethernet	UDP no-protocol communications on Ethernet	FINS/TCP no-protocol communications on Ethernet	RS-232C *1	Parallel communications	
									Sensor's standard parallel communications	Parallel Interface *2
EtherNet/IP		---	No	No	Yes	Yes	Yes	Yes	Yes	Yes
PLC Link on Ethernet		No	---	No	Yes	Yes	Yes	Yes	Yes	Yes
PROFINET		No	No	---	Yes	Yes	Yes	Yes	Yes	Yes
TCP no-protocol communications on Ethernet		Yes	Yes	Yes	---	No	No	No	Yes	Yes
UDP no-protocol communications on Ethernet		Yes	Yes	Yes	No	---	No	No	Yes	Yes
FINS/TCP no-protocol communications on Ethernet		Yes	Yes	Yes	No	No	---	No	Yes	Yes
RS-232C *1		Yes	Yes	Yes	No	No	No	---	Yes	No
Parallel communications	Sensor's standard parallel communications	Yes	Yes	Yes	Yes	Yes	Yes	No	---	No
	Parallel Interface *2	Yes	Yes	Yes	Yes	Yes	Yes	No	No	---

*1: This applies when an RS-232C Interface Sensor Data Unit is connected.

*2: This applies when a Parallel Interface Sensor Data Unit is connected.

Note

Connections Across Network Routers

You can connect to a Sensor on a different network than the Touch Finder or PC Tool through a router.

- If you are connecting to the Sensor from the Touch Finder / PC Tool, directly specify the IP address of the Sensor to connect. Auto Sensor Connection cannot be used to connect to a sensor on a different network over a router because the Sensor cannot be detected.
- Set a fixed IP address for the Sensor.
- When connected over a router, the connection recovery function cannot be used.

2-2 Part Names and Functions

FQ2-S1

FQ2-S2

FQ2-S3

FQ2-S4

FQ2-CH

FQ2-S□□□□□□-□□□ (Sensors with Built-in Lighting)

FQ2-CH1□□□□□-M (Sensors with Built-in Lighting)

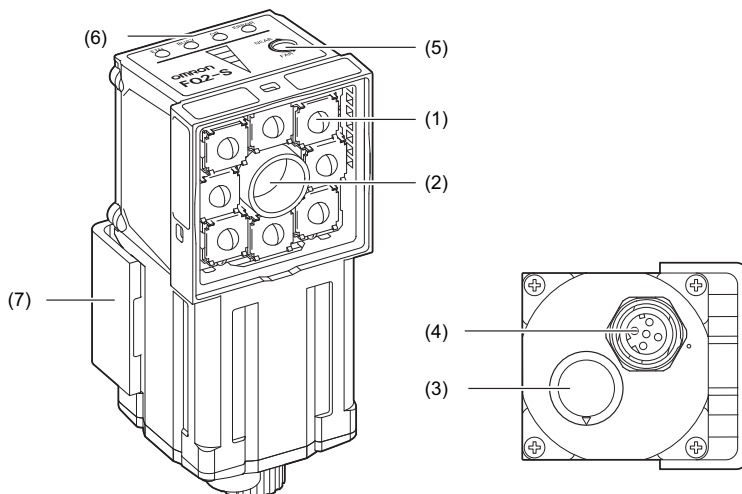

No.	Name	Description	
(1)	Lighting	LEDs for illumination	
(2)	Camera lens	This lens can be focused.	
(3)	I/O Cable connector	An FQ-WD or FQ-WU I/O Cable is used to connect the Sensor to the power supply and external I/O.	
(4)	Ethernet cable connector	An FQ-WN Ethernet Cable is used to connect the Sensor to external devices such as PLCs, the Touch Finder, or computers.	
(5)	Focus adjustment screw	Used to adjust the focus of the image.	
(6)	Operation indicators	OR	Lights orange when the overall judgment output (OR) signal turns ON.
		ETN	Lights orange during Ethernet communications.
		ERROR	Lights red when an error occurs. <input type="checkbox"/> 8-1 Error Histories: p.432
		BUSY	Lights green when the Sensor is executing a process. * You can change the BUSY indicator to a RUN indicator. This indicator is set by Default to a BUSY indicator, but if you change it to a RUN indicator, it will light green during operation. <input type="checkbox"/> Changing the Sensor's BUSY Indicator: p.429
(7)	Mounting Bracket	Used to mount the Sensor. The Mounting Bracket can be attached to the front, left side, right side, or back of the Sensor.	

FQ2-S□□-□□□ (Sensors with C-mounts)

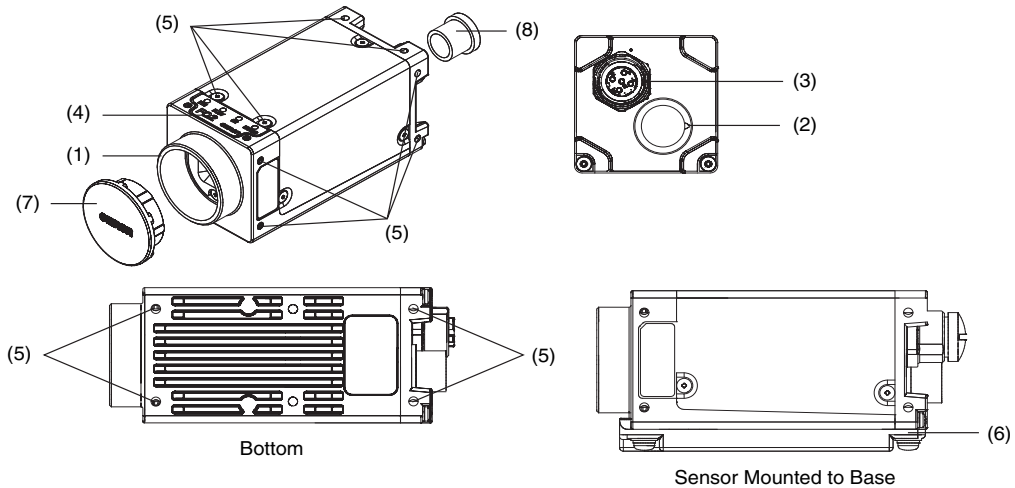

No.	Name	Description	
(1)	C-mount lens mounting surface	The C-mount lens and extension tube are attached here. Determine the appropriate CCTV lens (C-mount lens) to use based on the field of view required for the size of the measurement object. <i>Optical Diagrams: p. 42</i>	
(2)	I/O Cable connector	An FQ-WD or FQ-WU I/O Cable is used to connect the Sensor to the power supply, external I/O, and Sensor Data Unit.	
(3)	Ethernet Cable connector	An FQ-WN Ethernet Cable is used to connect the Sensor to external devices such as the Touch Finder or computers.	
(4)	Operation indicators	OR	Lights orange when the overall judgement output (OR) signal turns ON.
		ETN	Lights orange during Ethernet communications.
		ERROR	Lights red when an error occurs. <i>8-1 Error Histories: p.432</i>
		BUSY	Lights green when the Sensor is executing a process. * You can change the BUSY indicator to a RUN indicator. This indicator is set by Default to a BUSY indicator, but if you change it to a RUN indicator, it will light green during operation. <i>Changing the Sensor's BUSY Indicator: p.429</i>
(5)	Mounting holes	These mounting holes for M3 screws are used to mount the Camera and to mount to the base. There are mounting holes on the top, bottom, left, and right surfaces. <i>Dimensions: p. 559</i>	
(6)	Mounting base (enclosed)	The mounting base has 1/4-20UNC threads and is used to mount the Sensor. The base can be attached to the bottom, top, left, or right side of the Sensor. * We recommend mounting the Sensor with the mounting screw holes. The mounting base does not necessarily need to be used.	
(7)	C-mount cover	This cover is attached to the C-mount lens fitting when a lens is not attached.	
(8)	Connector cover	This cover is attached to the connection when an Ethernet Cable is not connected.	

Touch Finder

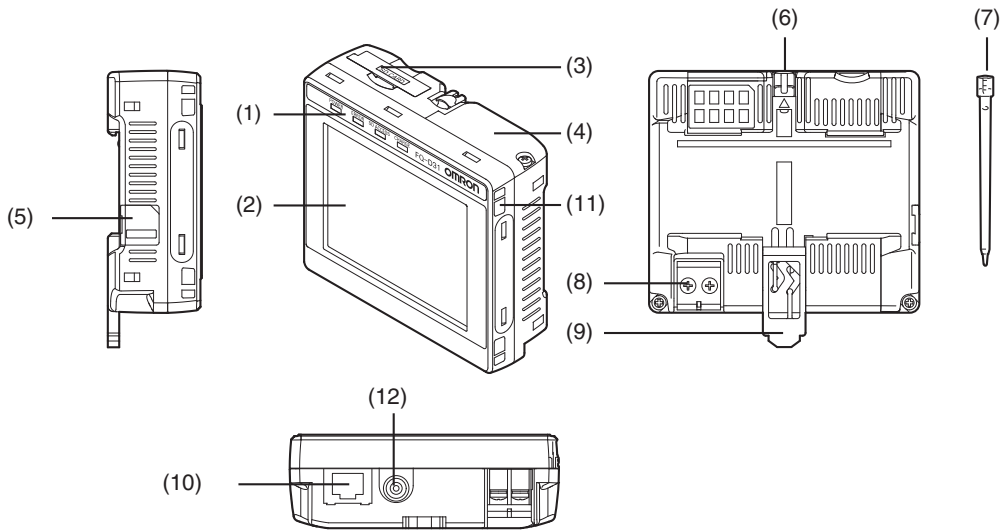

No.	Name	Description
(1)	Operation indicators	POWER Lights green when the Touch Finder is turned ON.
		ERROR Lights red when an error occurs. 8-1 Error Histories: p.432
		SD ACCESS Lights yellow when an SD card is inserted. Flashes yellow when the SD card is being accessed.
		CHARGE* ¹ Lights orange when the Battery is charging.
(2)	LCD/touch panel	Displays the setting menu, measurement results, and images input by the camera.
(3)	SD card slot	An SD card can be inserted.
(4)	Battery cover* ¹	The Battery is inserted behind this cover. Remove the cover when mounting or removing the Battery.
(5)	Power supply switch	Used to turn the Touch Finder ON and OFF.
(6)	Touch pen holder	The touch pen can be stored here when it is not being used.
(7)	Touch pen	Used to operate the touch panel.
(8)	DC power supply connector	Used to connect a DC power supply. Wiring the Touch Finder: p. 63
(9)	Slider	Used to mount the Touch Finder to a DIN Track.
(10)	Ethernet port	Used when connecting the Touch Finder to the Sensor with an Ethernet cable. Insert the connector until it locks in place.
(11)	Strap holder	This is a holder for attaching the strap.
(12)	AC power supply connector* ¹	Used to connect the AC adapter.

*1: Applicable to the FQ2-D31 only.

Sensor Data Units

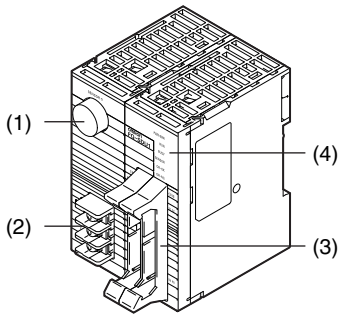

Front Surface of Parallel Interface
Sensor Data Unit

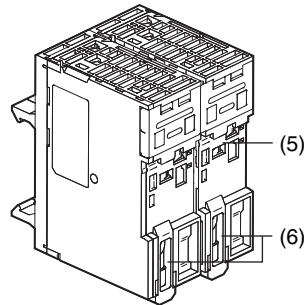

Back Surface of Parallel Interface
Sensor Data Unit

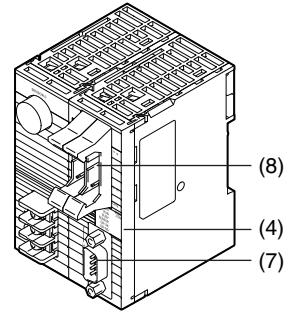

RS-232C Interface
Sensor Data Unit

No.	Name	Description	
(1)	Sensor connector	Connects to the FQ2-S3/S4/CH.	
(2)	Power supply and ground terminal block	Connects to the 24-V power source and the ground line.	
(3)	Parallel I/O connector	Connects to the I/O connector.	
(4)	I/O indicators	POWER/ ERROR	Lights green when power is being supplied. Lights red when an error occurs.
		RUN	Lights green during operation.
		BUSY	Lights yellow when the Sensor is executing a process.
		SENSOR	Lights yellow when the Sensor is connected.
		OR-OK	Lights green when the overall judgment result is OK.
		OR-NG	Lights red when the overall judgment result is OFF or an error occurs.
	232C_COM	Lights yellow during RS-232C communications. (Provided only on the FQ-SDU2□.)	
(5)	DIN Track mounting section	Mounts the Sensor Data Unit to a DIN Track.	
(6)	Slider	Used to secure the Sensor Data Unit to a DIN Track.	
(7)	RS-232C connector	Connects to the RS-232C connector.	
(8)	Parallel I/O connector	Connects to the I/O connector.	

2-3 Installation

FQ2-S1 FQ2-S2 FQ2-S3 FQ2-S4 FQ2-CH

Installing the Sensor

FQ2-S□□□□□□/ FQ2-CH1□□□□□-M (Sensors with Built-in Lighting)

Installation Procedure

- 1** Align the tabs on one side of the Mounting Bracket with the slot on the Sensor.

The FQ-XL Mounting Bracket can be attached to the back, side, or front of the Sensor.

- 2** Press the Mounting Bracket onto the Sensor until the other tabs click into place.

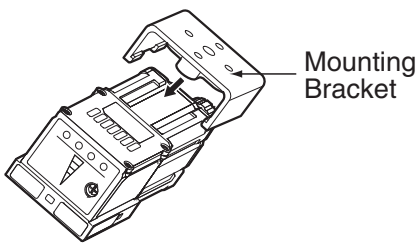

- 3** Use the following optical charts to check the field of view and installation distance of the Sensor so that it is mounted at the correct position.

Tightening torque (M4): 1.2 N·m

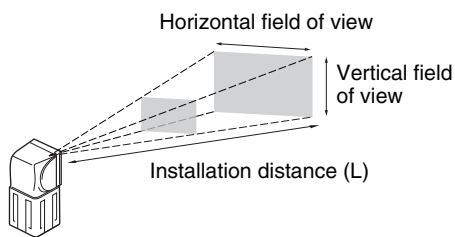

The optical chart indicates the horizontal field of view. The vertical field of view depends on the model as follows:

FQ2-S□□□□□□/FQ2-CH1□□□□□-M:
Approx. 60% of the horizontal field of view

FQ2-S□□□□□□-08□:
Approx. 90% of the horizontal field of view

Note: The tolerance is $\pm 10\%$.

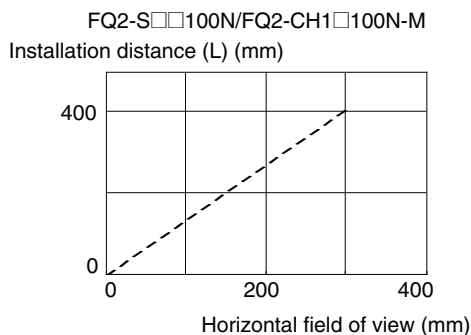
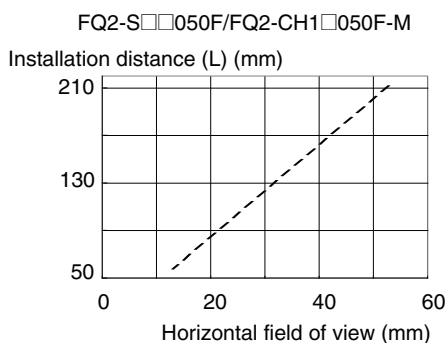
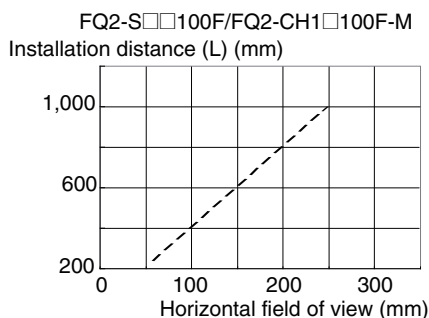
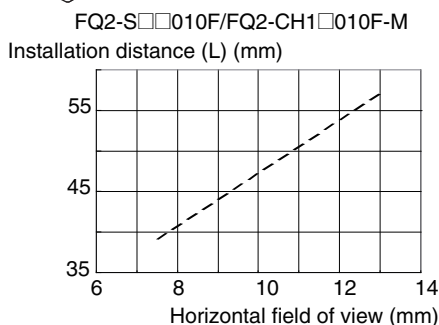

Important

- There is a certain amount of deviation among Sensors in the center of the optical axis. For this reason, when installing the Sensor, check the center of the image and the field of view on the LCD monitor of the Touch Finder and in the PC Tool.

Removal Procedure

- 1 Insert a flat-blade screwdriver between the Mounting Bracket and the Sensor case on either side and remove the Mounting Bracket.

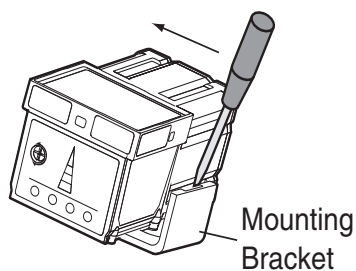

FQ2-S□-□□□ (Sensors with C-mounts)

Installation Procedure

Directly Mounting the Sensor

1 Mount the Sensor with M3 screws.

Tightening torque: 0.54 N·m

Effective depth of mounting holes: 4 mm

Important

Refer to the dimension drawings in the appendix for the positions of the screw holes.

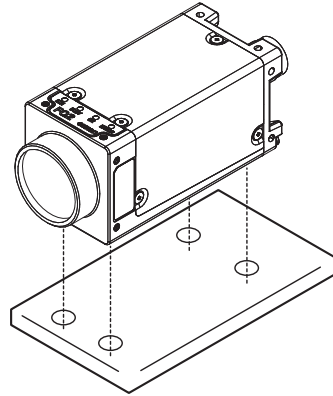

Mounting the Sensor to the Base

1 You can attach the mounting base to the bottom, top, left, or right surface.
(Recommended mounting screw tightening torque: 0.54 N·m)

Tightening torque: 0.54 N·m

Effective depth of mounting holes: 4 mm

2 Mount the Sensor with M3 screws.

Tightening torque: 0.54 N·m

Effective depth of mounting holes: 4 mm

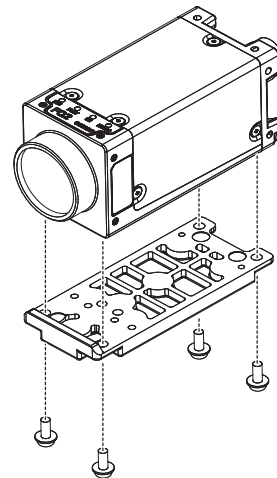

Lens Selection

Use the following optical diagrams to determine the Lens, camera installation distance, and detection range.

Optical Diagrams

The following values are estimates only. Adjustment is required after installing the camera.

3Z4S-LE SV-□□□□H High-resolution, Low-distortion Lenses

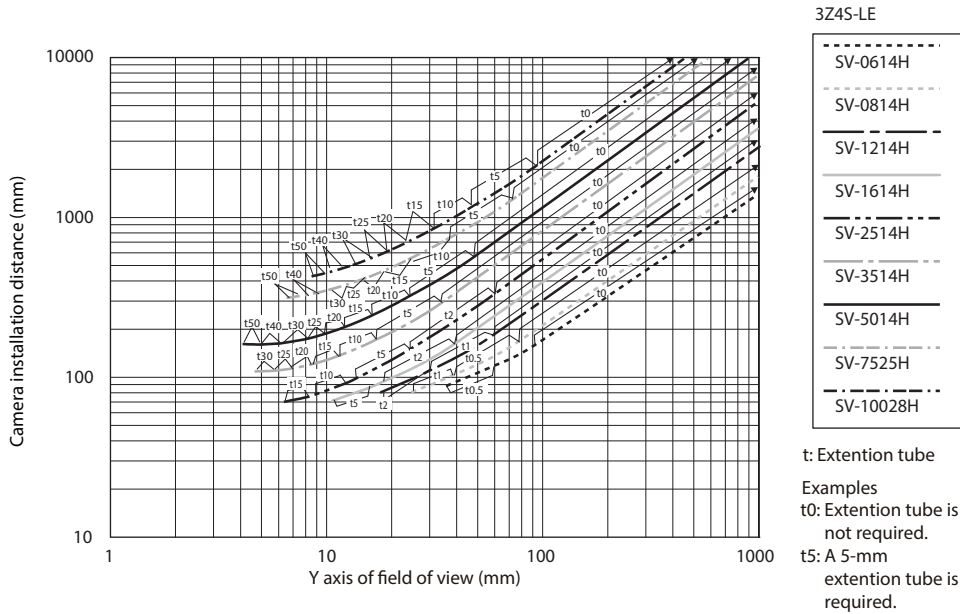

3Z4S-LE SV-□□□□V-series Lenses

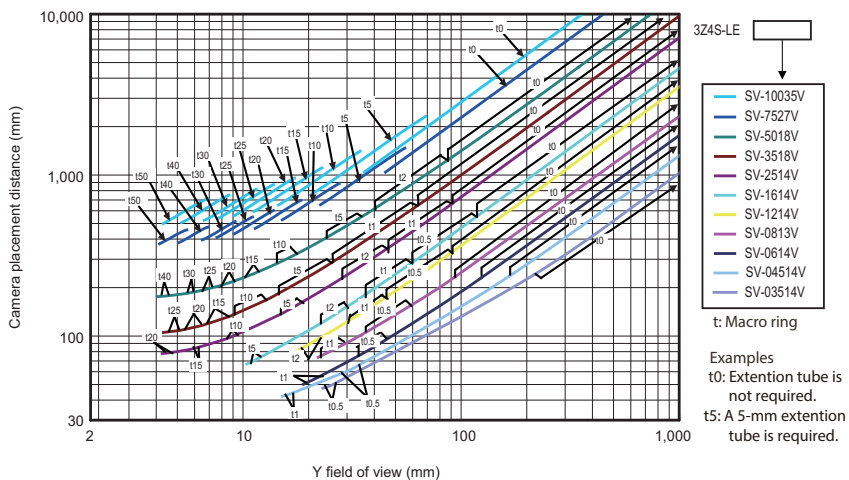

The X axis in the above optical diagrams represent field of view (mm)^{*1}.

The Y axis represents the camera installation distance (mm) or WD (mm). These optical diagrams show the relationship between the detection range and installation distance for different CCTV Lenses.

The values vary for each Lens.

Pay close attention to the Lens that you are using when you refer to these optical diagrams.

The macro ring thickness to be used is given as, for example "t5.0," on the graphs. "t0" means that a macro ring is not required. "t5.0" means that you must use a 5-mm macro ring.

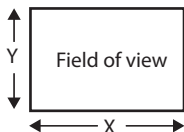

*1: The Y axis in the optical charts represents the height of the field of view.

Example: If you use an 3Z4S-LE SV-2514H Lens for a measurement object that requires field of view of 35 mm, the camera installation distance must be 200 mm and a 2-mm macro ring is required.

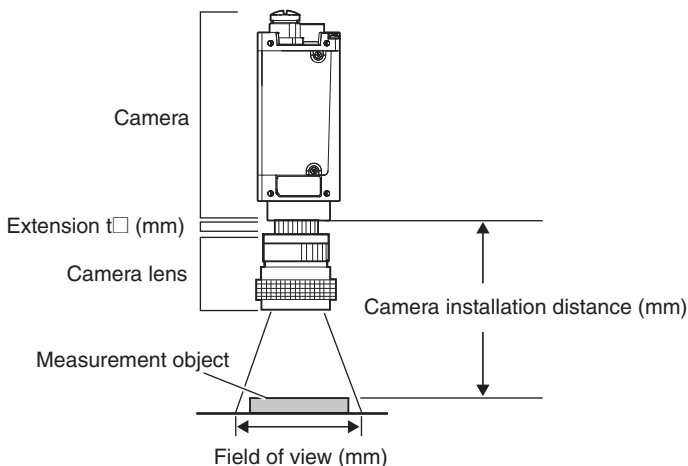

Lens Models and Dimensions

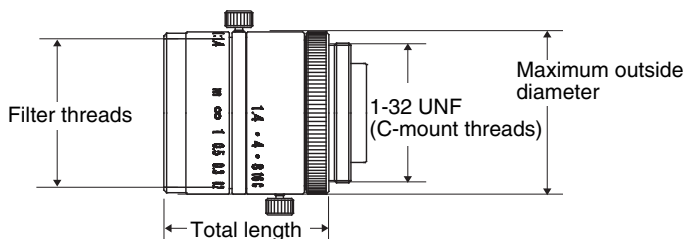

3Z4S-LE SV-□□□□H High-resolution, Low-distortion Lenses

Lens model	Focal length	Brightness	Maximum outside diameter	Total length	Filter size
3Z4S-LE SV-0614H	6.1 mm	F1.4	42 mm	57.5 mm	M40.5 P0.5
3Z4S-LE SV-0814H	8.0 mm	F1.4	39 mm	52.5 mm	M35.5 P0.5
3Z4S-LE SV-1214H	12.3 mm	F1.4	30 mm	51.0 mm	M27 P0.5
3Z4S-LE SV-1614H	16.2 mm	F1.4	30 mm	47.5 mm	M27 P0.5
3Z4S-LE SV-2514H	25.0 mm	F1.4	30 mm	36.0 mm	M27 P0.5
3Z4S-LE SV-3514H	35.01 mm	F1.4	44 mm	45.5 mm	M35.5 P0.5
3Z4S-LE SV-5014H	50.0 mm	F1.4	44 mm	57.5 mm	M40.5 P0.5
3Z4S-LE SV-7525H	75 mm	F2.5	36 mm	49.5 mm	M34.0 P0.5
3Z4S-LE SV-10028H	100 mm	F2.8	39 mm	66.5 mm	M37.5 P0.5

3Z4S-LE SV-□□□□V-series Lenses

Lens model	Focal length	Brightness	Maximum outside diameter	Total length	Filter size
3Z4S-LE SV-03514V	3.5 mm	F1.4	29.5 mm	30.4 mm	—
3Z4S-LE SV-04514V	4.5 mm	F1.4	29.5 mm	29.5 mm	—
3Z4S-LE SV-0614V	6.20 mm	F1.4	29 mm	30.0 mm	M27 P0.5
3Z4S-LE SV-0813V	8.05 mm	F1.3	28 mm	34.0 mm	M25.5 P0.5
3Z4S-LE SV-1214V	12.43 mm	F1.4	29 mm	29.5 mm	M27 P0.5
3Z4S-LE SV-1614V	16.34 mm	F1.4	29 mm	24.0 mm	M27 P0.5
3Z4S-LE SV-2514V	25.17 mm	F1.4	29 mm	24.5 mm	M27 P0.5
3Z4S-LE SV-3518V	34.75 mm	F1.8	29 mm	33.5 mm	M27 P0.5
3Z4S-LE SV-5018V	47.97 mm	F1.8	32 mm	37.0 mm	M30.5 P0.5
3Z4S-LE SV-7527V	76.71 mm	F2.7	32 mm	42.0 mm	M30.5 P0.5
3Z4S-LE SV-10035V	95.4 mm	F3.5	32 mm	43.9 mm	M30.5 P0.5

Macro Rings

Macro rings are inserted between the Lens and the camera to adjust the focus. You can use up to seven macro rings to achieve the required thickness.

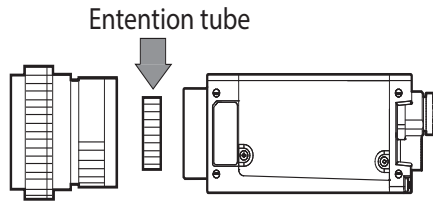

Model	Maximum outside diameter	Thickness
3Z4S-LE SV-EXR	31 mm	7-piece set Thickness: 0.5 mm 1 mm 2 mm 5 mm 10 mm 20 mm 40 mm

Important

- Do not stack 0.5 mm, 1.0 mm, and 2.0 mm macro rings. These sizes fit between the Lens and the threaded portion of other macro rings. If two or more are stacked together, the screw cannot be tightened securely.
- The macro rings may need to be reinforced depending on the vibration conditions if over 30 mm is used.

Installing the Touch Finder

Installation Precautions

Install the Touch Finder in the following orientation to allow sufficient heat dissipation.

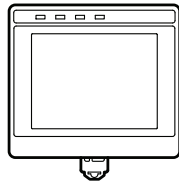

Do not mount it in the following orientations.

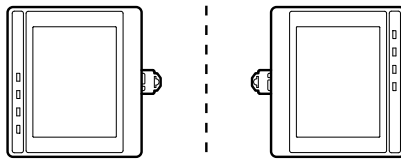

Important

- To improve ventilation, leave space on both sides of the Touch Finder. The distance between the Touch Finder and other devices should be at least that shown in the following diagram.

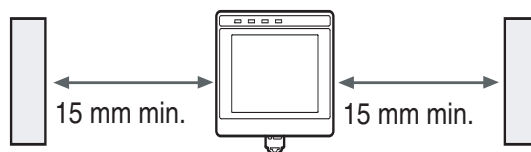

- Make sure that the ambient temperature is 50°C or lower. If it exceeds 50°C, install a cooling fan or an air conditioner and maintain the temperature at 50°C or lower.
- To prevent interference by noise, do not mount the Sensor on panels which contain high-voltage devices.
- To keep the level of noise from the surrounding environment to a minimum, install the Sensor and Touch Finder at least 10 m away from power lines.

Mounting to DIN Track

Installation Procedure

- 1** Press the slider on the Touch Finder to the top.
- 2** Hook the clip at the top of the Touch Finder on to the DIN Track.
- 3** Press the Touch Finder onto the DIN Track until the bottom clip clicks into place.

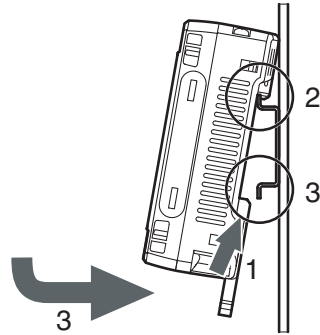

Important

- Attach End Plates (sold separately) on the sides of the Touch Finder on the DIN Track.
- If other devices will be installed next to the Touch Finder on the same DIN Track, make sure that sufficient space is kept between the devices as indicated on previous page.
- Always hook the clip at the top of the Touch Finder on the DIN Track first. If the lower clip is hooked on first, the Touch Finder will not be mounted very securely.

Removal Procedure

- 1** Pull down on the slider on the Touch Finder.
- 2** Lift the Touch Finder at the bottom and remove it from the DIN Track.

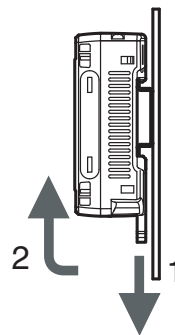

Mounting to a Control Panel

The Touch Finder can be mounted on a panel using the FQ-XPM Panel Mounting Adapter.

Important

- Always turn OFF the Touch Finder power before attaching or detaching the Panel Mount Adapter. Attaching or detaching with the power turned ON may cause a failure.

Installation Procedure

- 1** Set the Touch Finder in the Panel Mount Adapter.

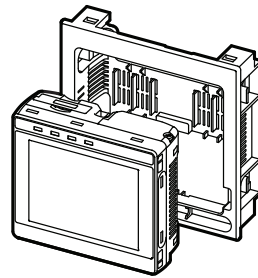

- 2** Press the slider up on the Touch Finder.

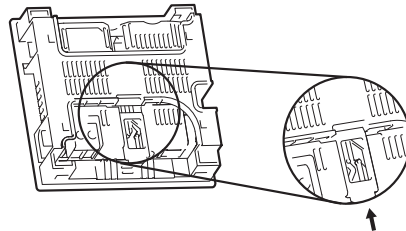

- 3** Create holes in the panel for mounting.
Refer to the following page for hole dimensions.

 *Dimensions: p.562*

- 4** Connect the cable to the Touch Finder.

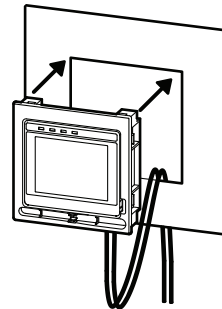

- 5** Mount the Touch Finder with the Panel Mount Adapter from the front of the panel.

- 6** Hook the hooks on the Mounting Bracket in the four holes of the Panel Mount Adapter and secure them with screws.
(Tightening torque: 1.2 N·m)

- 7** Check that the Touch Finder is attached properly to the Panel.

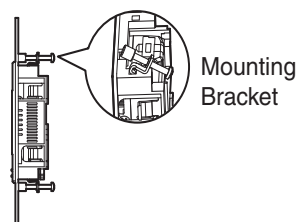

Removal Procedure

- 1** Take off the 4 Panel Mount Adapter's crews, then remove these Mounting Bracket.

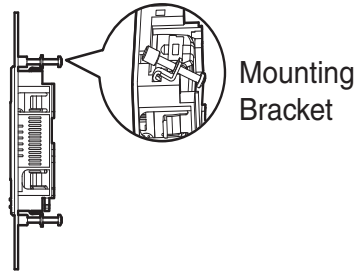

- 2** Remove the Touch Finder with the Panel Mount Adapter from the panel.

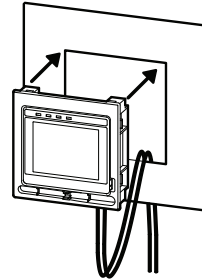

- 3** Take off a cable from the Touch Finder.

- 4** Press down the lock, then you are able to unlock.

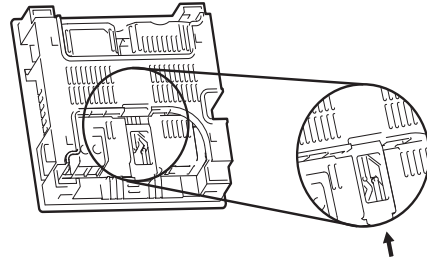

- 5** There are four Snap-fit parts on the back of the Touch Finder. For remove the Snap-fit part's hooks, put in a slotted screwdriver to these parts with pushing the Touch Finder.

- 6** Remove the Panel Adapter from the Touch Finder.

Using the Touch Finder as a Portable Device (with Battery)

The Touch Finder with a Battery can be used as a portable device. Use the strap when carrying it to prevent dropping it.

There are two types of straps (FQ-XH, sold separately), a Neck Strap and a Hand Strap.

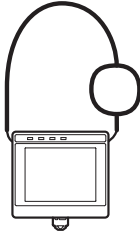

Neck Strap

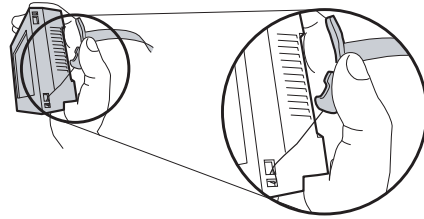

Hand Strap

1 Attach the Mini-strap to the Touch Finder.

There are a total of four holes for attaching the Mini-strap on the left and on the right of the Touch Finder.

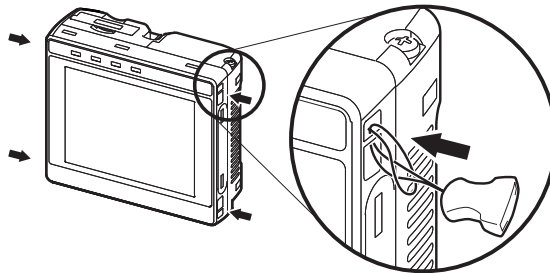

2 Connect the Neck Strap or Hand Strap to the Mini-strap.

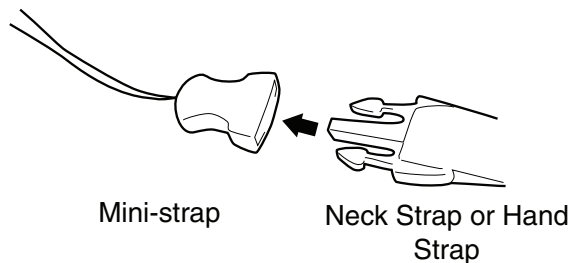

Mini-strap

Neck Strap or Hand Strap

Mounting Sensor Data Units

Mounting to DIN Track

Installation Procedure

- 1** Lock the sliders at the top and bottom of the Sensor Data Unit.
- 2** Press the slider on the Sensor Data Unit to the top.
- 3** Hook the clip at the top of the Sensor Data Unit on to the DIN Track.
- 4** Press the Sensor Data Unit onto the DIN Track until the bottom clip clicks into place.

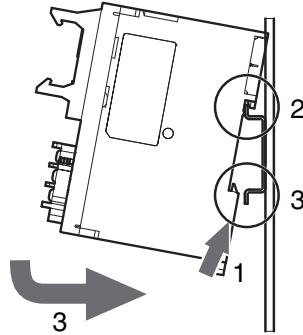

Important

- Attach End Plates (sold separately) on the sides of the Sensor Data Unit on the DIN Track.
- Always hook the clip at the top of the Sensor Data Unit on the DIN Track first. If the lower clip is hooked on first, the Touch Finder will not be mounted very securely.

Removal Procedure

- 1** Pull down on the slider on the Sensor Data Unit.
- 2** Lift the Sensor Data Unit at the bottom and remove it from the DIN Track.

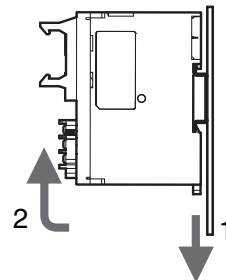

2-4 Launching the Program for First Time

FQ2-S1

FQ2-S2

FQ2-S3

FQ2-S4

FQ2-CH

Set the Language settings at the first launch of TouchFinder or TouchFinder for PC.

If you use Logging function or Calendar validation of OCR, Time settings is also required.

Language settings

The Language setting window appears at the first launch.

1 Select the language.



2 A dialog for selecting language appears.

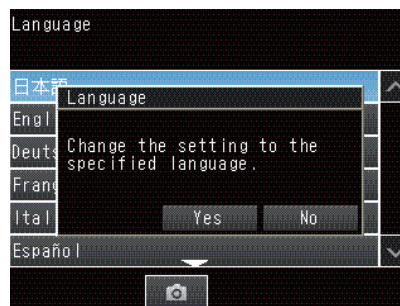

3 The screen changes to the selected language.

Time settings

- **When using the TouchFinder**

TouchFinder uses Day and Time information of your PC.

▶  (Run Mode) – [TF settings]

1 Touch the Time settings of TouchFinder.



2 Set day and time of TouchFinder.

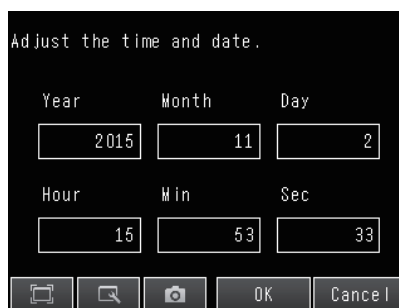

3 Touch the OK button.

- **When you use the PC Tool**

If you want to change these, perform the following procedure:

1 Click the Day and Time in Control Panel of Windows.

2 Set the Day and Time.

2-5 Wiring

FQ2-S1

FQ2-S2

FQ2-S3

FQ2-S4

FQ2-CH

Wiring the Sensor

Connect the I/O Cable to the I/O Cable connector located at the bottom of the Sensor.

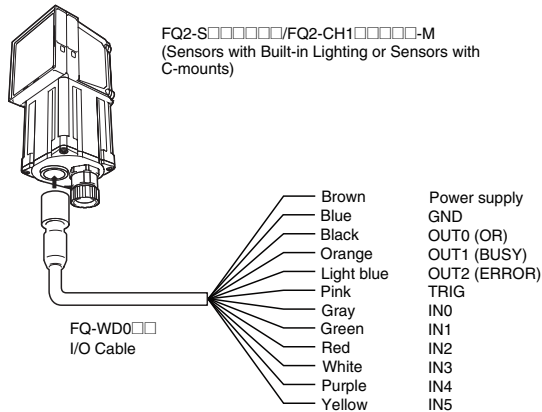

Important

- Cut off lines that are not required so that they do not come into contact the other signal lines.
- Do not allow the load current to exceed 50 mA.
The output circuit may be damaged if the load current exceeds 50 mA.

Classification	Signal	Application
Power supply	Power supply (24 V)	These terminals are for the external power supply (24 V).
	GND	Important Wire the power supply separately from other devices. If the wiring for other devices is placed together or in the same duct as the wiring for the Sensor, the influences of electromagnetic induction may cause the Sensor to malfunction or may damage it.
Inputs	TRIG	This terminal is the trigger signal input.
	IN0 to IN5	These are the command input terminals.
Outputs	OUT0 (OR)	By Default, this is the OR output signal (overall judgment). The assignment can be changed to RUN, READY, an individual judgment signal from OR0 to OR31, the STGOUT (strobe trigger output), or an expression judgment from 0 to 31.
	OUT1 (BUSY)	By Default, this is the BUSY output signal. The assignment can be changed to RUN, READY, an individual judgment signal from OR0 to OR31, the STGOUT (strobe trigger output), or an expression judgment from 0 to 31.
	OUT2 (ERROR)	By Default, this is the ERROR output signal. The assignment can be changed to RUN, READY, an individual judgment signal from OR0 to OR31, the STGOUT (strobe trigger output), or an expression judgment from 0 to 31.

Note

For the IN/OUT type of the Sensor and Sensor Data Unit, use the same IN/OUT type (NPN/PNP).

I/O Signal Circuit Diagrams

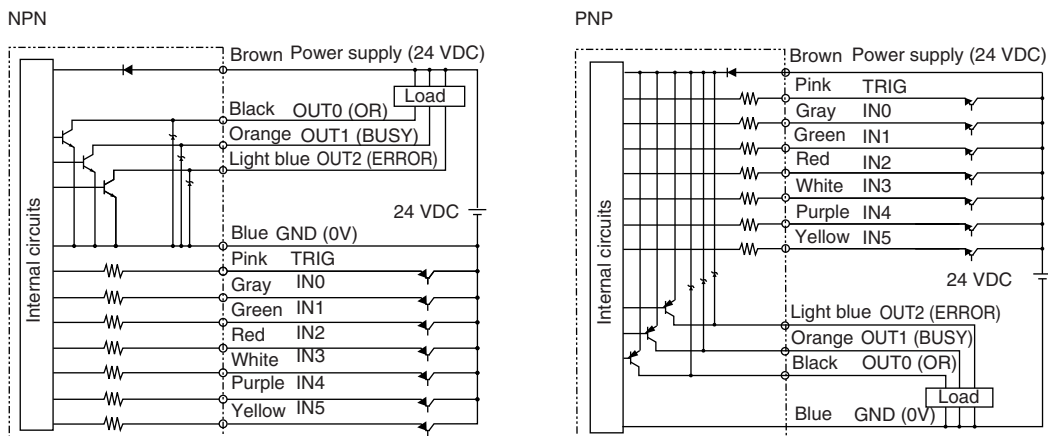

Important

Preventing Chattering

- The Sensor is equipped with an anti-chattering function, but if the chattering is 100 μ s or longer, a faulty input may occur. (Input signals of 99 μ s or shorter are ignored. Signals of 100 μ s or longer are treated as input signals.)
- Use no-contact output devices (e.g., SSR or PLC transistor output) for the input signals. If contacts (e.g., relay) are used, chattering may cause the trigger to be input again during execution of a measurement.

Power Supply Specifications When a Switching Regulator Is Connected

Use a power supply that meets the following specifications. (The power supply is sold separately.)

Item	Description	
	When connected to FQ2-S□□□□□□-□□□□ or FQ2-CH1□□□□□-M	When connected to FQ2-S□□-□□□
Power supply voltage	24 VDC (21.6 to 26.4 V)	
Recommended Power Supply	S8VS-06024□ (24 VDC, 2.5 A)	S8VS-01524□ (24 VDC, 0.65 A)
External power supply terminal screws	M4 (tightening torque: 1.2 N·m)	

Important

Supply power from a DC power supply for which measures have been applied to prevent high voltages (e.g., a safety extra low voltage circuit).

If UL certification is required for the overall system, use a UL Class II DC power supply.

Wiring Sensor Data Units

Parallel Interface Sensor Data Unit (FQ-SDU1□)

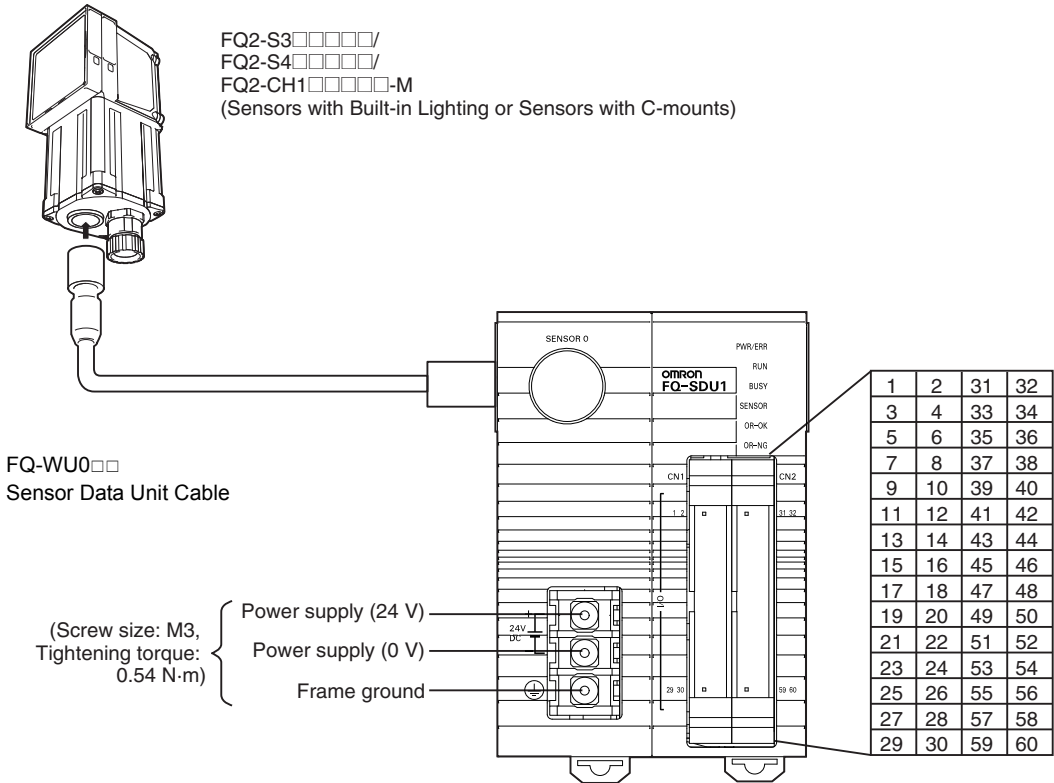

For the I/O connector harness, use an FQ-VP1□□□ Parallel Cable for the FQ-SDU1 or a MIL-standard harness, such as the OMRON XZ2F. (The Cables are sold separately.)

Pins 1 to 30 and pins 31 to 60 are for separate connectors. One FQ-VP1□□□ is required for each connector.

Signal	Application
Power supply (24 V)	These terminals are for the external power supply (24 V).
Power supply (0 V)	<p>Important</p> <ul style="list-style-type: none"> • Wire the power supply separately from other devices. If the wiring for other devices is placed together or in the same duct as the wiring for the Sensor, the influence of electromagnetic induction may cause the Sensor to malfunction or may damage it. • Do not allow the load current to exceed 50 mA. The output circuit may be damaged if the load current exceeds 50 mA.
Frame ground	This is the frame ground terminal. Connect the ground wire by a D-type ground (ground resistance of 100Ω or less).

Note

For the IN/OUT type of the Sensor and Sensor Data Unit, use the same IN/OUT type (NPN/PNP).

FQ-SDU10/SDU15 Terminal Signal Names

Pin	Signal	FQ-VP1 Wire color	IN/ OUT	Function
1	COMOUT1	Brown	-	Output signal common (DO0 to DO15)
2	NC ^{*1}	Red	-	
3	D0	Orange	OUT	Data output
4	D1	Yellow	OUT	Data output
5	D2	Green	OUT	Data output
6	D3	Blue	OUT	Data output
7	D4	Purple	OUT	Data output
8	D5	Gray	OUT	Data output
9	D6	White	OUT	Data output
10	D7	Black	OUT	Data output
11	D8	Brown	OUT	Data output
12	D9	Red	OUT	Data output
13	D10	Orange	OUT	Data output
14	D11	Yellow	OUT	Data output
15	D12	Green	OUT	Data output
16	D13	Blue	OUT	Data output
17	D14	Purple	OUT	Data output
18	D15	Gray	OUT	Data output
19	NC ^{*1}	White	-	
20	NC ^{*1}	Black	-	
21	NC ^{*1}	Brown	-	
22	NC ^{*1}	Red	-	
23	NC ^{*1}	Orange	-	
24	NC ^{*1}	Yellow	-	
25	NC ^{*1}	Green	-	
26	NC ^{*1}	Blue	-	
27	NC ^{*1}	Purple	-	
28	NC ^{*1}	Gray	-	
29	NC ^{*1}	White	-	
30	NC ^{*1}	Black	-	

Pin	Signal	FQ-VP1 Wire color	IN/ OUT	Function
31	COMIN0	Brown	-	Input signal common (all inputs except TRIG)
32	COMIN1	Red	-	Input signal common (TRIG)
33	TRIG	Orange	IN	Measurement trigger input
34	NC ^{*1}	Yellow	-	
35	NC ^{*1}	Green	-	
36	RESET	Blue	IN	Reset input
37	IN0	Purple	IN	Command input
38	IN1	Gray	IN	Command input
39	IN2	White	IN	Command input
40	IN3	Black	IN	Command input
41	IN4	Brown	IN	Command input
42	IN5	Red	IN	Command input
43	IN6	Orange	IN	Command input
44	IN7	Yellow	IN	Command input
45	NC ^{*1}	Green	-	
46	NC ^{*1}	Blue	-	
47	DSA	Purple	IN	Data send request signal
48	NC ^{*1}	Gray	-	
49	NC ^{*1}	White	-	
50	NC ^{*1}	Black	-	
51	NC ^{*1}	Brown	-	
52	ACK	Red	OUT	Command execution completed flag
53	RUN	Orange	OUT	ON during measurement mode
54	BUSY	Yellow	OUT	ON during process execution
55	OR	Green	OUT	Overall judgement result
56	ERROR	Blue	OUT	ON during error
57	STGOUT	Purple	OUT	Strobe trigger output ^{*2, *3}
58	SHTOUT	Gray	OUT	Shutter trigger output ^{*4}
59	GATE	White	OUT	ON during the set output time.
60	COMOUT0	Black	-	Output signal common (ACK, RUN, BUSY, OR, ERROR, STGOUT, SHTOUT, and GATE)

- *1: Leave all signal terminals that are labeled "NC" open.
- *2: You can select whether to turn the external lighting ON (Positive) or OFF (Negative) when the signal turns ON. (The setting is called the strobe output polarity.)
 -  *FQ2-S/CH Series User's Manual for Communications Settings (Cat. No. Z338)*
Section 2 Controlling Operation and Outputting Data with a Parallel Connection
- *3: This control signal is used to turn ON external lighting when an image is taken. Connect this signal to external lighting.
- *4: This signal is output to an external device when exposure of the imaging elements is completed. If you want to move the Sensor to the next measurement location after a measurement is completed, move the Sensor only after this signal turns ON.
Shutter Output Signal (SHTOUT)

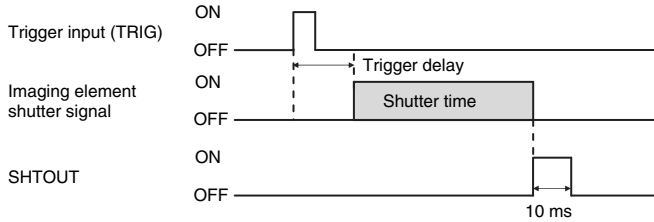

The SHTOUT signal turns ON for approximately 10 ms (fixed) when the shutter time (exposure period) elapses after the trigger is input from an external device.

RS-232C Interface Sensor Data Unit (FQ-SDU2□)

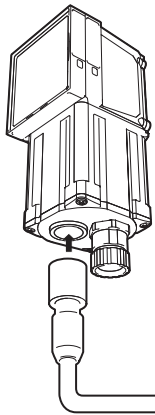

FQ2-S3□□□□□-□□□
 FQ2-S4□□□□□-□□□
 FQ2-CH1□□□□□-M
 (Sensors with Built-in Lighting or Sensors with C-mounts)

FQ-WU0□□
 Sensor Data Unit Cable

(Screw size: M3,
 Tightening torque:
 0.54 N·m)

Power supply (24 V)
 Power supply (0 V)
 Frame ground

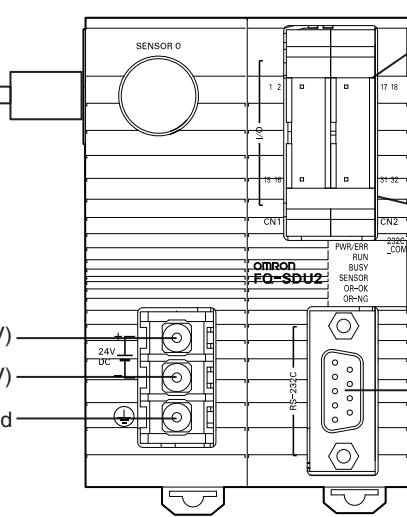

1	2	17	18
3	4	19	20
5	6	21	22
7	8	23	24
9	10	25	26
11	12	27	28
13	14	29	30
15	16	31	32

RS-232C connector

For the I/O connector harness, use an FQ-VP2□□□ Parallel Cable for the FQ-SDU2 or a MIL-standard harness, such as the OMRON XZ2F. (The Cables are sold separately.)

Pins 1 to 16 and pins 17 to 32 are for separate connectors. One FQ-VP2□□□ is required for each connector.

Signal	Application
Power supply (24 V)	These terminals are for the external power supply (24 V).
Power supply (0 V)	<p>Important</p> <ul style="list-style-type: none"> • Wire the power supply separately from other devices. If the wiring for other devices is placed together or in the same duct as the wiring for the Sensor, the influence of electromagnetic induction may cause the Sensor to malfunction or may damage it. • Do not allow the load current to exceed 50 mA. The output circuit may be damaged if the load current exceeds 50 mA.
Frame ground	<p>This is the frame ground terminal.</p> <p>Connect the ground wire by a D-type ground (ground resistance of 100Ω or less).</p>

FQ-SDU20/SDU25 Parallel Pin Signal Names

Pin	Signal	FQ-VP2 Wire color	IN/OUT	Function
1	IN0	Brown	IN	Command input
2	IN1	Red	IN	Command input
3	IN2	Orange	IN	Command input
4	IN3	Yellow	IN	Command input
5	IN4	Green	IN	Command input
6	IN5	Blue	IN	Command input
7	NC ^{*1}	Purple	-	
8	NC ^{*1}	Gray	-	
9	NC ^{*1}	White	-	
10	NC ^{*1}	Black	-	
11	NC ^{*1}	Brown	-	
12	NC ^{*1}	Red	-	
13	NC ^{*1}	Orange	-	
14	NC ^{*1}	Yellow	-	
15	NC ^{*1}	Green	-	
16	NC ^{*1}	Blue	-	

Pin	Signal	FQ-VP2 Wire color	IN/OUT	Function
17	COMIN0	Brown	-	Input signal common (RESET and IN0 to IN5)
18	COMIN1	Red	-	Input signal common (TRIG)
19	TRIG	Orange	IN	Measurement trigger input
20	NC ^{*1}	Yellow	-	
21	NC ^{*1}	Green	-	
22	RESET	Blue	IN	Reset input
23	NC ^{*1}	Purple	-	
24	ACK	Gray	OUT	Command execution completed flag
25	RUN	White	OUT	ON during measurement mode
26	BUSY	Black	OUT	ON during process execution
27	OR	Brown	OUT	Overall judgment result
28	ERROR	Red	OUT	ON during error
29	STGOUT	Orange	OUT	Strobe trigger output
30	SHTOUT	Yellow	OUT	Shutter trigger output
31	NC ^{*1}	Green	-	
32	COMOUT0	Blue	-	Output signal common (ACK, RUN, BUSY, OR, ERROR, STGOUT, and SHTOUT)

*1: Leave all signal terminals that are labeled "NC" open.

FQ-SDU20/SDU25 RS-232C Pin Signal Names

RS-232C Connector

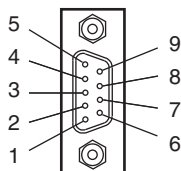

Pin No.	Signal name	Function
1	NC	Not connected
2	RD	For RS-232C
3	SD	For RS-232C
4	NC	Not connected
5	GND	Signal ground
6	NC	Not connected
7	NC	Not connected
8	NC	Not connected
9	NC	Not connected

Pin numbers will depend on the external device being connected. Refer to the manual for the personal computer or PLC being connected.

Use a compatible connector. The followings are recommended items.

	Manufacturer	Model
Socket	OMRON Corporation	XM3D-0921
Hood	OMRON Corporation	XM2S-0911

Wiring

The maximum cable length is 15m.

- RS-232C

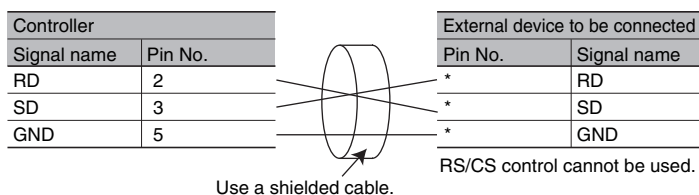

Connection Method

Align the connector with the socket and press it straight into place, then fix it with the screws on both sides of the connector.

Important

Turn OFF the power supply before connecting or disconnecting a Cable. Peripheral devices may be damaged if the cable is connected or disconnected with the power ON.

I/O Signal Circuit Diagrams

NPN

Input Circuit

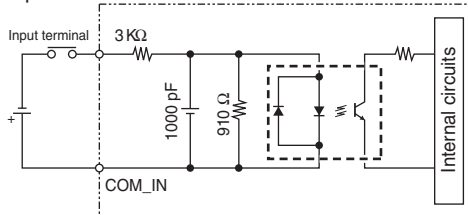

Output Circuit

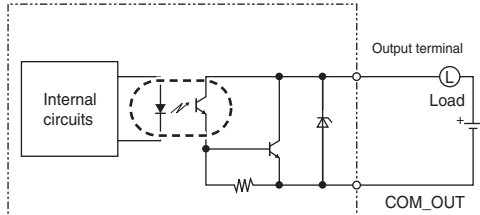

PNP

Input Circuit

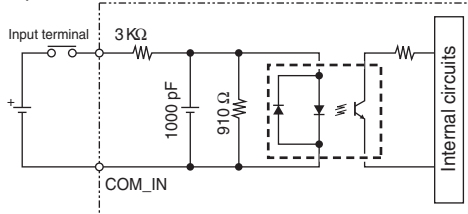

Output Circuit

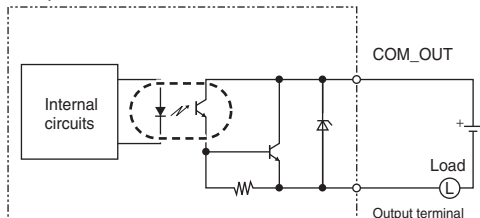

Important

Preventing Chattering

- The Sensor is equipped with an anti-chattering function, but if the chattering is 100 μs or longer, a faulty input may occur. (Input signals of 99 μs or shorter are ignored. Signals of 100 μs or longer are treated as input signals.)
- Use no-contact output devices (e.g., SSR or PLC transistor output) for the input signals. If contacts (e.g., a relay) are used, chattering may cause the trigger to be input again during execution of a measurement.

Power Supply Specifications When a Switching Regulator Is Connected

Use a power supply that meets the following specifications. (They are sold separately.)

Item	Description	
	When connected to FQ2-S□□□□□□□□□□ or FQ2-CH1□□□□□□□□-M	When connected to FQ2-S□□□□□□□□
Power supply voltage	24 VDC (21.6 to 26.4 V)	
Recommended Power Supplies	S8VS-06024□ (24 VDC, 2.5 A)	S8VS-03024 (24 VDC, 1.3 A)
External power supply terminal screws	M4 (tightening torque: 1.2 N·m)	

Important

Supply power from a DC power supply for which measures have been applied to prevent high voltages (e.g., a safety extra-low-voltage circuit).

If UL certification is required for the overall system, use a UL Class II DC power supply.

Wiring the Touch Finder

Power Supply Wiring

Connecting the Power Supply

- 1** Loosen the two terminal screws using a Phillips screwdriver.
- 2** Attach crimp terminals to the power lines. Secure the positive and negative lines as indicated using M3 screws.

Power supply tightening torque: 0.54 N·m

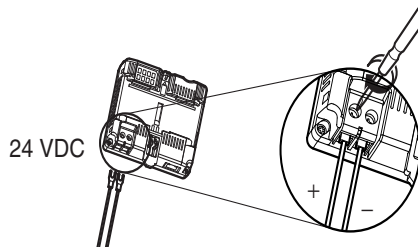

- 3** In environments where there is excessive noise, attach a ferrite core (ZCAT1730-0730 from TDK or the equivalent) to the power supply cable.

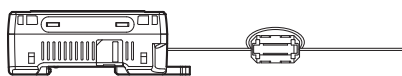

When you attach the ferrite core to the power supply cable, wrap the cable only one time.

Turning ON the Touch Finder

1 Remove the cover from the power switch on the left side of the Touch Finder.

2 Press the switch toward ON.

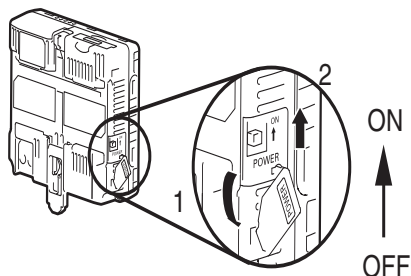

Power Supply Specifications

Use a power supply that meets the following specifications. (The power supply is sold separately.)

Item	Description
Power supply voltage	24 VDC (21.6 to 26.4 V)
Output current	0.65 A min.
Recommended Power Supply	S8VS-01524□ (24 VDC, 0.65 A)
External power supply terminal screws	M3.5 (tightening torque: 1.0 N·m)
Recommended power line wire size	AWG16 to AWG22 (length of 5 m max.)

Important

- Supply power from a DC power supply for which measures have been applied to prevent high voltages (e.g., a safety extra-low-voltage circuit).
If UL certification is required for the overall system, use a UL Class II DC power supply.
- When using the FQ2-D31, do not connect a switching regulator and AC Adapter (FQ-AC□) at the same time.

Charging the Battery

This section describes how to charge and install the FQ2-D31 Battery and provides applicable precautions.

Charge the Battery while it is attached to the Touch Finder.

Use the AC adapter to charge the battery.

Mounting the Battery in the Touch Finder

- 1 Remove the screw from the battery cover on the top of the Touch Finder, slide the cover in the direction of the arrow, and open the battery cover.

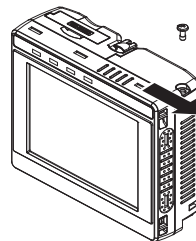

- 2 Face the rounded side of the battery toward the back of the Touch Finder and insert the battery.

Important

Do not insert the battery in the wrong orientation.

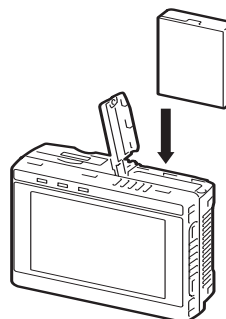

- 3 Close the battery cover, slide the battery cover in the direction of the arrow, and tighten the screw on the battery cover.

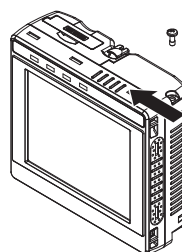

- 4 Attach the AC adapter to the Touch Finder to start charging the battery.

The CHARGE indicator will be lit while the battery is being charged.

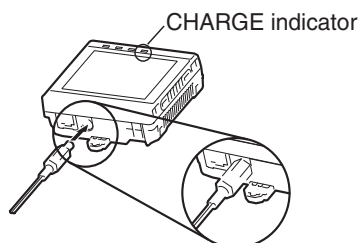

Note

The Touch Finder will operate even if the AC adapter is connected when no battery is mounted in the Touch Finder.

Important

- If the Touch Finder (FQ2-D31) will be installed permanently or semi-permanently, remove the Battery (FQ-BAT1). If the rated temperature is exceeded with the Battery inserted, the protective circuit may activate and stop the Touch Finder.
- The battery complies with the following recycling regulation.



- California regulations concerning perchlorate:

This product is a lithium battery that contains perchlorate, which is regulated by the State of California. Please comply with these regulations. For details see the following URL:

www.dtsc.ca.gov/hazardouswaste/perchlorate/

2-6 Setting Up Ethernet

FQ2-S1

FQ2-S2

FQ2-S3

FQ2-S4

FQ2-CH

Connecting to Sensors from the Touch Finder

Configurations Consisting of Only Sensors and the Touch Finder

When only Sensors and a Touch Finder are used, IP addresses are automatically assigned. No settings are required to use Ethernet.

Connections on Existing Networks

If a Sensor or Touch Finder is connected to a network where a PLC or computer is already connected, the Ethernet settings must be made compatible with the existing network.

Set the IP addresses with one of the following methods.

• Sensor

▶  (Setup Mode) – [Sensor settings] – [Network] – [Ethernet] – [IP address setting]

1 Press [Fixed].

2 Set the IP address and subnet mask according to the network settings.

Note

- If you connect the Touch Finder or PC Tool to a Sensor on a different network through a router, set fixed IP addresses.
- When connecting by EtherNet/IP or PROFINET, set fixed IP addresses for the Sensors.

• TouchFinder

▶  (Setup Mode) – [TF settings] – [Ethernet] – [AUTO]

1 Press [OFF].

2 Set the IP address and subnet mask according to the network settings.

● Using a DHCP Server

- Sensor

▶  (Setup Mode) – [Sensor settings] – [Network] – [Ethernet] – [IP address setting]

1 Press [DHCP].

- TouchFinder

▶  (Setup Mode) – [TF settings] – [Ethernet] – [AUTO]

1 Press [ON].

Connecting to Sensors from External Devices Such as PLCs

Set the IP address of the Sensor according to the network where the external devices, such as PLCs, are connected.

▶  (Setup Mode) – [Sensor settings] – [Network] – [Ethernet] – [IP address setting]

1 Press [Fixed].

2 Set the IP address and subnet mask according to the network where the external devices, such as PLCs, are connected.

Note

If you connect OMRON CS/CJ-series PLCs to the Ethernet, the following Default IP addresses are assigned to the PLCs.

- IP address: 192.168.250.*node_address*

Connecting to Sensors from a Computer Using the PC Tool

Configurations Consisting of Only Sensors and a Computer (PC Tool)

If the configuration consists only of Sensors and a Touch Finder, set the network settings on the computer as described below.

(No IP address settings are required on the Sensors.)

The following procedure is for Windows 7.

- 1** Select [Control Panel] from the Windows Start.
- 2** Click [Network and Internet] on Control Panel.
- 3** Click [Network and Sharing Center].
- 4** Click [Change adapter settings] on the left side of [Network and Sharing Center].
- 5** Click the [Local Area Connection] icon in the Network connection window.
- 6** Select [Internet Protocol Version 4 (TCP/IPv4)] in [Local Area Connection Properties], and click [Properties].

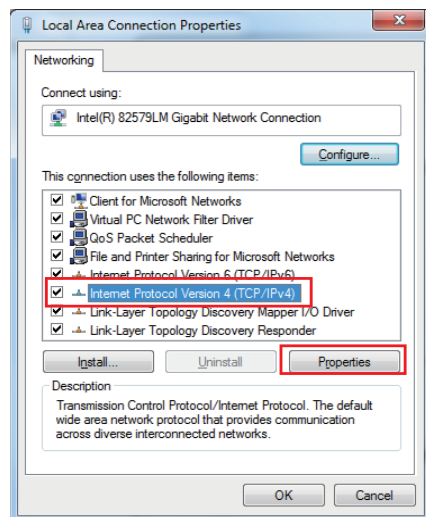

7 Select the *Use the following IP address Option* and enter the following IP address and subnet mask.

- IP address: 10.5.5.101
- Subnet mask: 255.255.255.0

8 Click the [OK] Button. This completes the settings.

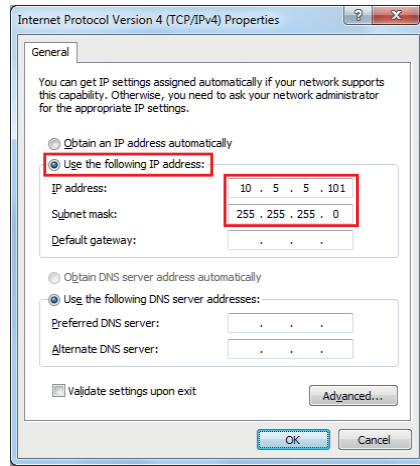

Connections on Existing Networks

Set the Ethernet settings of the Sensors and the computer (PC Tool) to the same settings as the existing network. Refer to *Connecting to Sensors from the Touch Finder* on page 67 for the IP address settings in the Sensors.

Note

- If you connect the PC Tool to a Sensor on a different network through a router, set fixed IP addresses.
- When connecting by EtherNet/IP or PROFINET, set fixed IP addresses for the Sensors.

Select the IP address to be used by PC Tool

The computer IP address, subnet address, and Default gateway that are used by the PC Tool are displayed. If multiple IP addresses (network cards) exist in the computer, the IP address to be used for the PC Tool can be selected.

▶ (Setup Mode or Run Mode) – [TF settings] – [Ethernet] – [IP address]

- 1** A list of the computer IP addresses that can be used by the PC Tool appears. Touch the list to select an IP address.

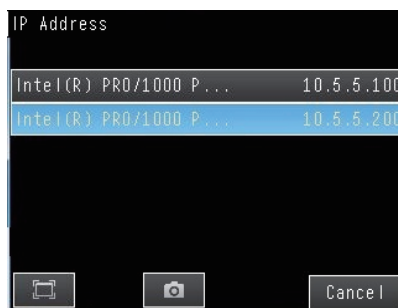

- 2** The Sensor List appears.

The connected sensor is temporarily disconnected.

To refresh the list, touch [Update list] of any sensor.

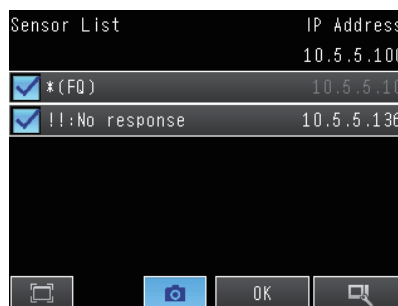

- 3** Select the sensor that you want to connect and touch [OK]. (The sensor is reconnected.)

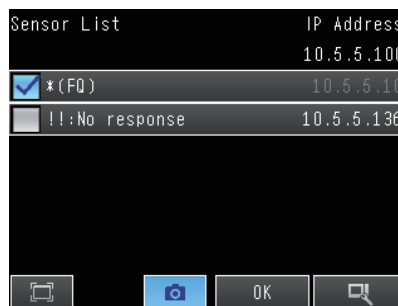

Note

- If you want to change the IP address, change the network settings of the computer and then select the IP address using the above procedure.
- If the list does not appear, check if the LAN is correctly connected.

MEMO

Taking Images

3-1 Selecting a Sensor for Configuration	74
3-2 Setting Conditions for Taking Images.....	75
3-3 Adjusting Image Quality	76
3-4 Adjusting the Timing of Taking Images.....	87
3-5 Adjusting the Images That Were Taken.....	91

3-1 Selecting a Sensor for Configuration

FQ2-S1

FQ2-S2

FQ2-S3

FQ2-S4

FQ2-CH

If multiple Sensors are connected to a single Touch Finder or computer, a list of the Sensors that are connected is displayed by Default. Use the following procedure to change to the Sensor to set up.

1 Press  – [Switch Sensor].

2 Touch the image of the sensor to be set, and touch [OK].

 will be displayed for Sensors that are not yet set.

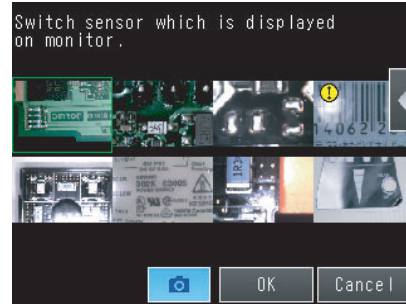

Note

Once the Touch Finder detects and records a Sensor, the display order for showing more than one Sensor is fixed. Even if the system configuration is changed to reduce the number of Sensors, the previous display location will remain for Sensors that were removed.

To update the displays of multiple Sensors to the current connection status, go to Run display - [Sensor monitor] - [Multi sensor], and touch [◀] - [Display position] - [◀] - [Auto position] on the right of the display.

3 Press  – [Sensor settings] to return to Setup Mode.



4 Press [Yes].

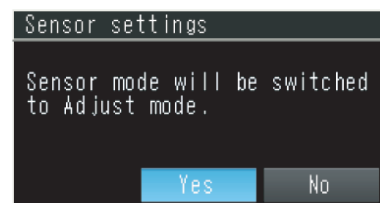

Note

There are different methods that you can use to connect the Sensors. For example, you can automatically connect to the Sensors that are recognized by the Touch Finder, or you can manually register the Sensors to connect.

 7-5 Connecting to More Than One Sensor: p. 386

3-2 Setting Conditions for Taking Images

FQ2-S1

FQ2-S2

FQ2-S3

FQ2-S4

FQ2-CH

You can set the conditions for taking images to use in inspections.

To enable accurate judgments, the following adjustments are made for the conditions for taking images and the images themselves.

Taking Clear Images (Camera Setup)

Adjusting the Focus  p. 76

Adjust the focus of the Lens.

Taking Bright Images of Dark Objects and Taking Clear Images of Moving Objects  p. 77

Adjust the shutter speed and gain.

Improving the Image Quality of Metallic and Other Shiny Surfaces (HDR)  p. 83

Make adjustments for shiny objects or metallic surfaces.

For a Sensor with built-in lighting, attach a polarizing filter to cut specular reflections.

Adjusting the Colors of the Image (White Balance)  p. 85

Adjust the white balance so that the colors match those of the actual measurement object.



Adjusting the Timing of Taking Images (Trigger Setting)

Trigger Delay  p. 87

Adjust the timing of taking an image with the Sensor.



Adjusting the Images That Were Taken (Image Adjustment)

Filtering the Images (Filter Items)  p. 93

Apply filters to adjust the images that were taken.

Compensating for Position Offset (Position Compensation Items)  p. 102

Recognize measurement objects that are not in a consistent location and move them to the center of the image.

3-3 Adjusting Image Quality

FQ2-S1

FQ2-S2

FQ2-S3

FQ2-S4

FQ2-CH

Adjusting the Focus

► [Image] – [Camera setup]

1 Display the Camera Setup Display.

The focus can be seen as a numerical value.
The higher the value, the better the focus.



Focus Level

2 Adjust the focus of the Sensor while checking the image and focus value on the Touch Finder.

For a Sensor with Built-in Lighting, manually adjust the focus using the focus adjustment screw on the Sensor.

In the Default settings, the field of view is set to the narrowest setting.

For a Sensor with a C-mount, use the focus ring on the lens to adjust the focus of the image.

Focus adjustment screw

Turn clockwise to focus on closer objects.
(The field of view will narrow.)



Turn the screw counterclockwise to focus on objects at a distance.
(The field of view will widen.)

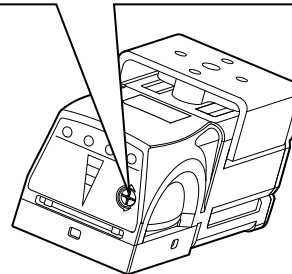

Sensor with Built-in Lighting

3 Press [Back].

Important

- Turn the focus adjustment screw clockwise or counterclockwise a little bit to make sure that it has not already reached the dead stop. Do not force the screw if it does not rotate anymore. This will damage the Sensor.
- Do not turn the focus adjustment screw with a force that is greater than 0.1 N·m. This may damage it.

Adjusting Image Brightness with External Lighting

You can adjust image brightness with external lighting or by setting the Sensor sensitivity.

Using a Strobe Trigger Signal to Control External Lighting

If a Sensor Data Unit is connected, you can change the output time of the strobe trigger signal (STGOUT) to adjust the brightness.

 *FQ2-S/CH Series User's Manual for Communications Settings (Cat. No. Z338)
Section 2 Controlling Operation and Outputting Data with a Parallel Connection*

Adjusting the Brightness

You can adjust the shutter speed/gain or the brightness to make images brighter. The setting method depends on whether HDR Mode is ON or OFF. The setting methods are described below.

 *HDR Function: p. 83*

Important

The exposure time will be longer for higher values of the shutter speed or brightness. This may cause the image to blur if the object is moving fast. If the Sensor is used on a high-speed line, check that the images are not blurred under actual operating conditions.

Brightness Correction Mode (FQ2-S1□□□□/ FQ2-S2□□□□/ FQ2-S4□□□□/ FQ2-S4□□□□-M)

If the brightness changes inconsistently with each image, turn ON the Brightness Correction Mode.

When HDR is ON: ► [Brightness] – ◀ – [Brightness correction]

When HDR is OFF: ► [Gain] – ◀ – [Brightness correction]

When Brightness Correction Mode is ON, the brightness will be consistent but the timing of image capture will be delayed by 25 ms (when the shutter speed is 1/250 or faster, i.e., the exposure time is shorter).

When built-in lighting is OFF and the shutter speed is slower than 1/250, i.e., the exposure time is longer, the image capture timing will be further delayed.

Make sure that appropriate images of the measured objects are captured when Brightness Correction Mode is ON.

Timing Chart When the Brightness Correction Mode Is ON

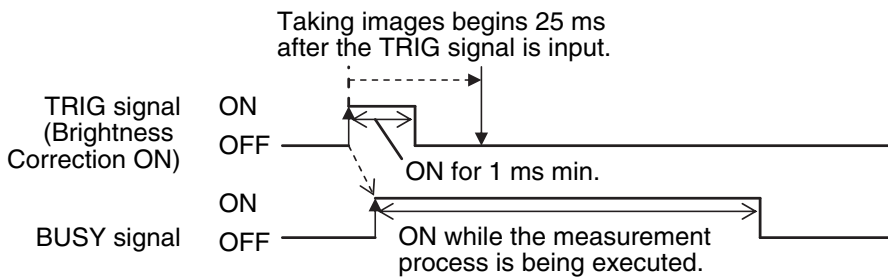

📖 *FQ2-S/CH Series User's Manual for Communications Settings (Cat. No. Z338)*
Section 2 Controlling Operation and Outputting Data with a Parallel Connection

Important

If the gain is increased, the brightness will not be stable and measurement values may be inconsistent. We recommend that you turn ON the Brightness Connection Mode.

When HDR Is OFF

The brightness of the image is adjusted by adjusting the shutter speed. If the brightness cannot be improved by adjusting the shutter speed, the gain is adjusted.

Relationship between the Shutter Speed/Gain and the Image Brightness (For FQ2-S3/S4 series)

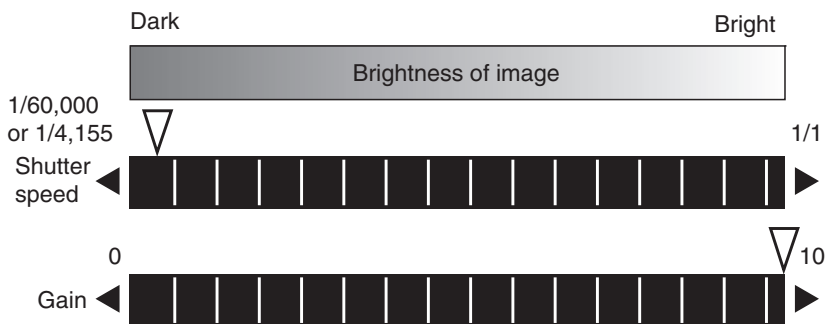

Note

- Adjust the shutter speed not only to adjust the brightness of the image, but also to adjust for the travel speed of the measurement object.

 *Taking Clear Images of Moving Objects: p. 82*

- Increasing the gain will make the image brighter, but it will also reduce image quality to the point that the noise component in the images will stand out. Select a suitable factor for the inspection.

► [Image] – [Camera setup]

1 Press [] – [Shutter speed] on the right of the display.

2 Move the bar to the left or right to adjust the shutter speed.

Moving it to the left will make the shutter speed slower and the image brighter. Moving it to the right will make the shutter speed faster and the image darker.



3 Press [OK].

If you cannot obtain the required brightness by adjusting the shutter speed, adjust the gain

4 Press [◀] – [Gain] on the right of the display.

5 Move the bar to the left or right to adjust the gain.

Moving it to the right will increase the gain and make the image brighter. Moving it to the left will reduce the gain and make the image darker.



6 Press [OK].

7 Press [Back].

Parameter	Setting	Description
Shutter speed	Range: For FQ2-S3*-*-*-, FQ2-S4*-*-* 1/1 to 1/4,155 For FQ2-S3****-08*, FQ2-S4****-08* Built-in lighting off: 1/1 to 1/4,155 Built-in lighting on: 1/250 to 1/60,000 (control by lighting emission time)	If the shutter speed is slow, the image will be bright. If the shutter speed is fast, the image will be dark.
	For FQ2-S1****, FQ2-S2****, FQ2-S4*, For FQ2-S4****M, FQ2-CH1****-M Built-in lighting off: 1/1 to 1/50,000 Built-in lighting on: 1/250 to 1/50,000 Default: 1/250	
Gain	For FQ2-S3****-08*, FQ2-S3*-*-*-, FQ2-S4****-08*, FQ2-S4*-*-* Range: 0 to 10 Default: 0 For FQ2-S1****, FQ2-S2****, FQ2-S4****, FQ2-S4****-M, FQ2-CH1****-M Range: 16 to 64 Default: 16	If the gain is high, the image will be bright. If the gain is low, the image will be dark.

Important

- To ensure stable operation when the FQ2-S1□□□□/FQ2-S2□□□□/ FQ2-S4□□□□/ FQ2-S4□□□□-M is connected, we recommend that you set the gain to 16.
- If the recommended value is exceeded, the brightness will not be stable and measurement values may be inconsistent. We recommend that you turn ON the Brightness Connection Mode.

If a slow shutter speed (1/1 to 1/10) and a high gain are set, fixed-pattern noise (fleck and striped noise) will sometimes occur. Be sure to thoroughly check the images and the measurement results when you set the shutter speed and gain.

When HDR Is ON

Set the brightness adjustment value.

The higher the brightness adjustment value, the brighter the image.

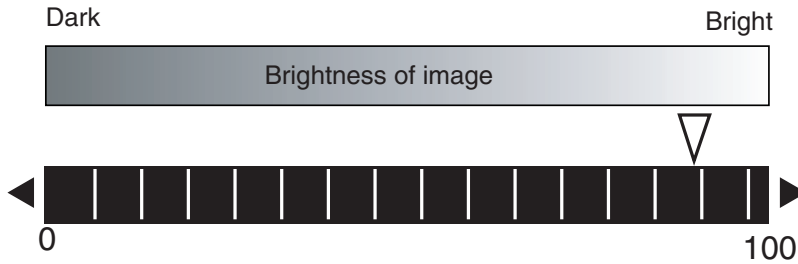

► [Image] – [Camera setup]

1 Press [◀] – [Brightness] on the right side of the display.

2 Move the bar to the left or right to adjust the brightness.

Moving it to the right will make the image brighter, while moving it to the left will reduce the brightness of the image.

3 Press [OK].



Taking Clear Images of Moving Objects

For quick moving objects, the effect of blurring can be reduced by decreasing the shutter speed. In HDR Mode, set the brightness value to a low setting.

• Relationship between Shutter Speed and the Brightness Adjustment Value in HDR Mode

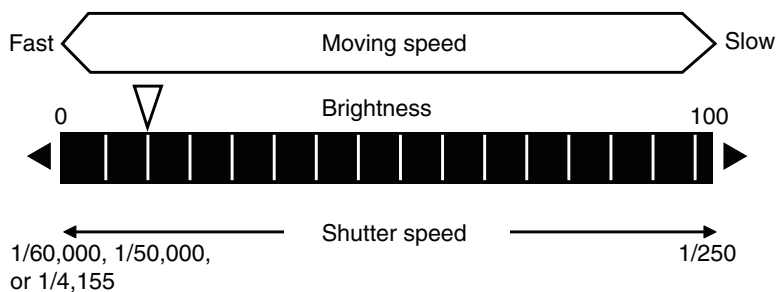

Refer to the following page for the setting methods for the shutter speed and brightness.

 *Adjusting the Brightness: p. 77*

Important

The lower the shutter speed/gain and brightness settings are, the darker the image becomes. If the Sensor is used in a dark environment, make sure that the darkness of the image does not cause the measurements to be unstable.

Improving the Image Quality of Metallic and other Shiny Surfaces

When objects with shiny surfaces are being measured, the lighting may be reflected off the surface and affect the image.

To remove reflections, one of the following two functions can be used.

Function	Description
HDR (High Dynamic Range)	If objects have contrasting light and dark areas, the dynamic range can be made wider to improve the quality of the images.
Polarizing filter (for Sensors with Built-in Lighting)	Specular reflections can be eliminated from an image by attaching a polarizing filter to the Sensor. If the measurement object must be moving, use a polarizing filter. Also, if reflections cannot be sufficiently removed by using the HDR function, use a polarizing filter as well.

HDR Function

The HDR function is used for objects that have a large difference between light and dark areas. For this kind of object, clear images cannot be achieved with the standard brightness setting.

The HDR function combines several images of different brightnesses (shutter speed) so that the resulting image has a lower degree of contrast and can be measured stably for the desired characteristic.

Inputting Images with a Limit Range of Brightness

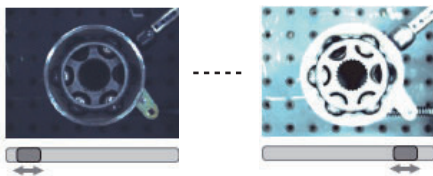

Combining Images to Create an Image with a Wide Dynamic Range

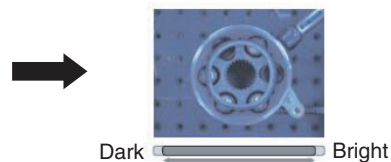

Observe the following precautions.

Use the HDR function only for objects that are not moving to avoid image blurring.

Several images are taken with different shutter speeds and combined.

If the object moves while the image is being taken, the image will become blurred.

Images with different brightnesses are combined, so the resulting image will have a lower degree of contrast.

► [Image] – [Camera setup]

1 Press [◀] – [HDR] on the right side of the display.

2 Set the best level for the HDR Mode.

As shown below, the higher the level, the wider the combined dynamic range will be.

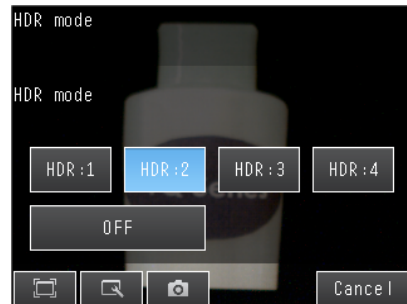
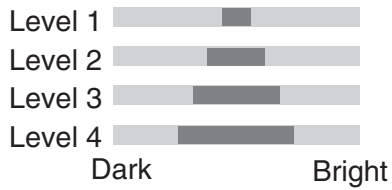

Using a Polarizing Filter (Only for Sensors with Built-in Lighting)

Specular reflections can be eliminated from an image by attaching an FQ-XF1 Polarizing Filter to the Sensor.

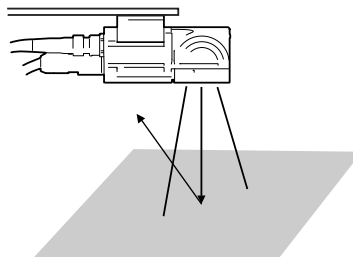

Observe the following precautions.

- The image will be darker compared to when no filter is used.
- If the image becomes too dark, adjust the brightness.

 Adjusting the Brightness

- *When HDR Is OFF: p. 79*
- *When HDR Is ON: p. 81*

• Mounting the Filter

- 1 Hook the filter in the hole at the top of the Sensor.

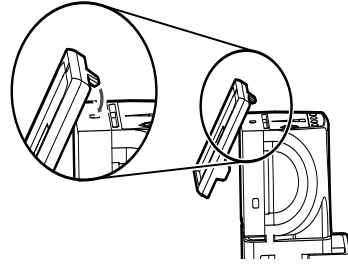

- 2 Using the top section as a pivot point, pull down the filter so that it attaches to the Sensor.

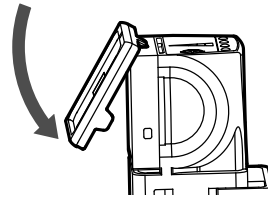

Adjusting the Colors of the Image (White Balance) (Only for Sensors with Color Cameras)

If external lighting is used, the image may appear as having different colors than the actual object. If this is the case, adjust the white balance.

If the lighting built in to the Sensor is used, the white balance is already adjusted. No setting is required in this case.

► [Image] – [Camera setup]

- 1 Input a picture of white paper or cloth.
- 2 Press [◀] – [White balance] on the right side of the display.

- 3** Press the [Auto] Button. The Sensor will automatically adjust the colors.
- 4** Move the bar to the left (light) or right (dark) to fine-tune the colors.
- 5** Press [OK].



Rotating the Touch Finder Image by 180°

You can rotate the Camera image by 180°. This setting also applies to re-measurement of logged images.

► [Image] – [Camera setup] – [◀] – [Rotate 180]

3-4 Adjusting the Timing of Taking Images

FQ2-S1 FQ2-S2 FQ2-S3 FQ2-S4 FQ2-CH

Delaying the Image Capture Timing from the Trigger Input

If the measurement object is moving, the position in the image of the feature that is to be measured will depend on the timing of the trigger signal.

A delay can be applied from when the trigger (i.e., the TRIG signal) is input until when the image is taken to synchronize the timing of image capture with the speed of moving objects.

If the object position varies in the image, this delay cannot be used to make the object position more stable. When you use a trigger delay with external lighting, you will also need to adjust the timing to turn ON external lighting.

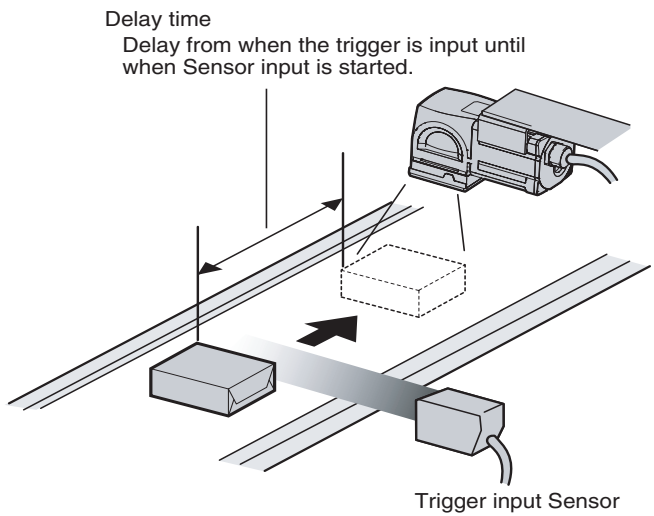

► [Image] – [Trigger setup] – [Trigger delay]

- 1 A TRIG signal is input.
Images are input continuously.
- 2 Select the image with the measurement object in the center using ◀ and ▶.
- 3 Press the image.
- 4 Press [OK].

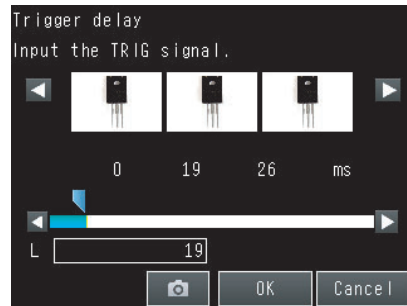

Setting item	Setting value	Description
Trigger delay	Range: 0 to 163ms Default: 0	Adjusts the time for opening the camera shutter after Trigger conditions are established. Only valid for external triggers. Delay time = (Setting value) + 150μs

Note

The delay time can be set using the adjustment bar or by directly entering a value.

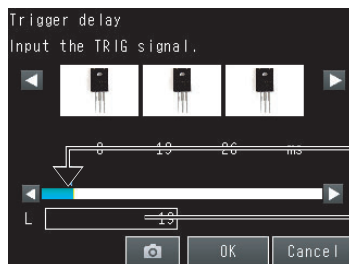

Move the bar to the left or right.
Or
Directly input the delay time.

Adjusting External Lighting Timing

When you use a trigger delay, you must adjust the timing to turn ON external lighting so that it matches the trigger delay timing.

Using a Strobe Trigger Signal to Control External Lighting

If a Sensor Data Unit is connected, you can change the output time of the strobe trigger signal (STGOUT) to adjust the timing of the external lighting.

 *FQ2-S/CH Series User's Manual for Communications Settings (Cat. No. Z338)*
Section 2 Controlling Operation and Outputting Data with a Parallel Connection

▶ [Image] – [Camera setup] – [◀] – [Lightning control]

Preventing Mutual Interference of Multiple Sensors

When the same trigger signal is input to multiple Sensors, the lighting from one Sensor may affect the measurements of the other Sensors. This is called mutual interference. This kind of interference can be prevented offsetting the image input timing of each Sensor from when the trigger signal is received.

Example:

A trigger (i.e., the TRIG signal) is input to Sensor 0 and Sensor 1 at the same time.

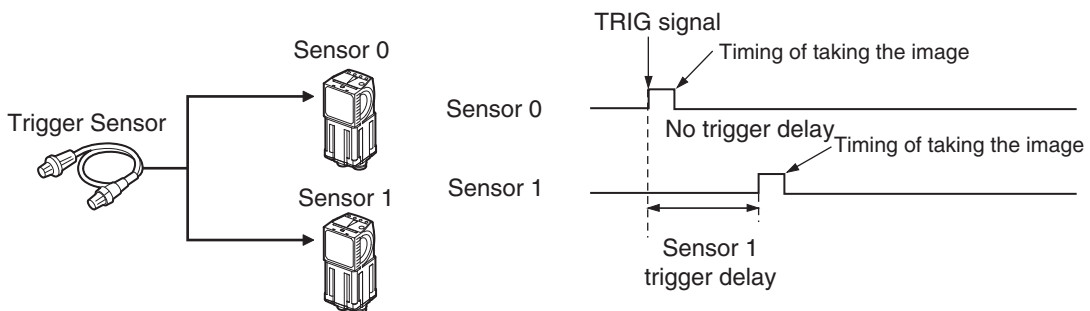

Sensor 0 immediately begins image input when the trigger is input.
Sensor 1 begins image input after the specified time has passed.

1 Change to the setup for to Sensor 1.

 3-1 *Selecting a Sensor for Configuration: p. 74*

2 Press [Image] – [Trigger setup] – [Trigger delay].

3 Set the trigger input delay time for Sensor 1.

 *Delaying the Image Capture Timing from the Trigger Input: p. 87*

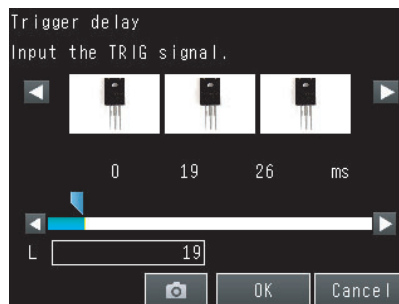

Important

The delay time for preventing mutual interference must be longer than the shutter time.

When the lighting built into the Sensor is used, the shutter time is 4 ms max. Therefore make the delay at least 4 ms.

3-5 Adjusting the Images That Were Taken

FQ2-S1

FQ2-S2

FQ2-S3

FQ2-S4

FQ2-CH

Image Adjustment

You can adjust the image that is taken by the Sensor to make it easy to measure. There are mainly the following two types of items that you can use to adjust the image.

- Filtering the Images (Filter Items)
These items filter the image by eliminating image noise with filters to make them suitable for measurement.
- Compensating for Position Offset (Position Compensation Items)
These items compensate for offset in the position or orientation of the image.

You can combine several filter items and position compensation items to adjust the image that was taken. (You can use a total of up to eight filter and position compensation items combined.)

Flow of Image Adjustment

The image that is taken by the Camera (called the Camera image) is adjusted in the order that the filter and position compensation items are registered.

Note

You can specify the order of image adjustment by registering the items in the desired order, but you cannot change the order of the items after you register them.

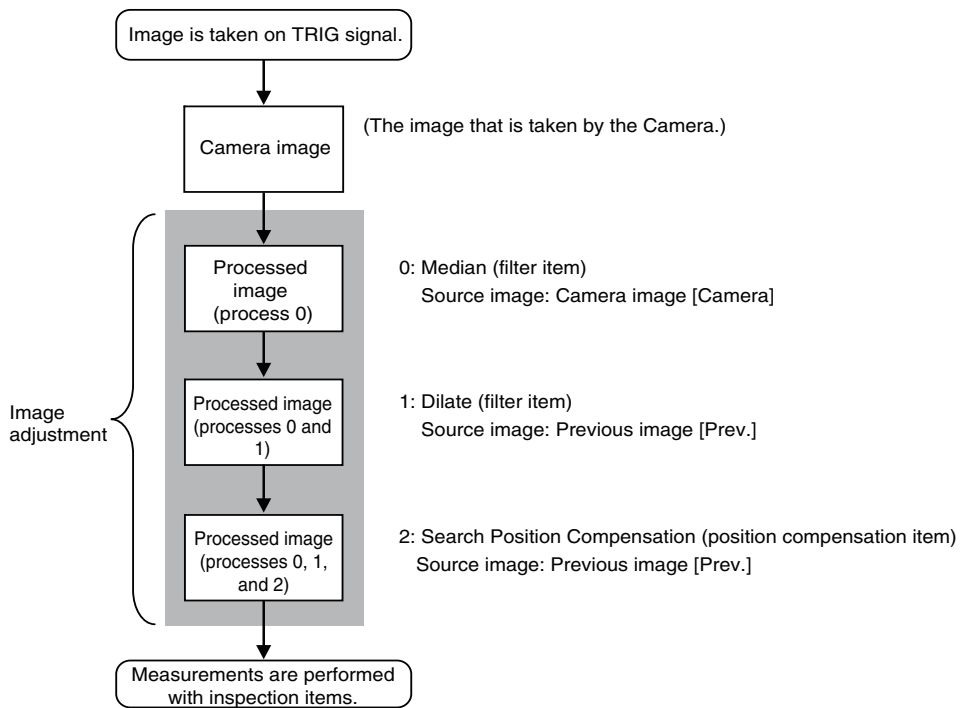

Note

Specify the Camera image for the first filter item for image processing.

If you execute more than one filter item for the image, set the source image for the other filter items to the previous image. Also, you can perform image processing with filter items only to enable processing with position compensation items.

In that case, only the position information from position compensation is applied to the image to be measured.

For details, refer to *Using Filter Items for Processing with Position Compensation Items* on page 106.

Filtering the Images (Filter Items)

You can filter the images that are taken by the Camera to make them easier to measure. This is used in the following cases.

- To cut unnecessary backgrounds so that they are not measured
- To remove noise

To stably find the edges of marks when other edges have been clearly extracted

Applicable Filters

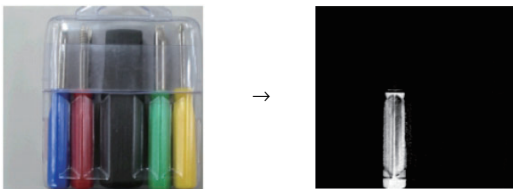
Selected filter item	Description
Color Gray Filter (only for Sensors with Color Cameras)	<p>Converts an image that was input from a Color Camera to a monochrome image. Example: You can extract an image that contains only a specific color.</p>  <p>Extracting an Image That Contains Only Red</p> <div style="border: 1px solid black; padding: 2px; width: fit-content; margin-bottom: 10px;">Note</div> <ul style="list-style-type: none"> • This inspection item cannot be used for monochrome images. An NG (image error) will result if you use it for a monochrome image. • All inspection items after the Color Gray Filter item will be performed in the same way as when a Monochrome Camera is connected.
Weak Smoothing	Used when there are minor irregularities in the measurement object.
Strong Smoothing	The image is feathered to reduce unevenness.
Dilate	Used when there is dark noise. Dark noise is removed by dilating bright places.
Erosion	Used when there is bright noise. Bright noise is removed by eroding bright places.
Median	Used when there are minor irregularities in the measurement object. Unevenness is reduced while maintaining outlines.
Extract Edges	Extracts image edges between light and dark.
Extract Horiz. Edges (extract horizontal edges)	Extracts horizontal edges between light and dark in the image.
Extract vertical edges	Extracts vertical edges between light and dark in the image.
Enhance edges	Enhances image edges between light and dark.

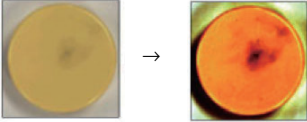
Selected filter item	Description
Background Suppression	<p>Extracts a specific range of brightness to increase the image contrast and suppress the unnecessary background.</p> <p>Example: Increasing Contrast</p>  <p>Any areas that are outside of the specified range of brightness are removed as the background. Also, the brightness within the specified range is converted to 256 levels to enhance the contrast.</p>

Setting Filter Items





► [Image] – [Image adjustment]

- 1 Press an unused number, and then press [Add filter].
- 2 Press the filter item to use.
- 3 Make any detailed settings as required for the filter.

Refer to the detailed settings for each of the following filter items.



- 4 Press [OK].
- 5 Press [Back].
- 6 Make any the following settings as required for each filter item.

- *Setting the Source Image for Filtering*  p. 95
- *Setting the Region to Filter*  p. 95
- *Setting the Filter Type (for Color Gray Filter Only)*  p. 96
- *Setting the Brightness Range to Extract (for Background Suppression Item Only)*  p. 98

Setting the Image to Filter (Source Image)

You must set the image to which the filter is to be applied.

► [Image] – [Image adjustment] – [Add filter] – (Filter item to select)

1 Press [◀] – [Source image] on the right of the display.

2 Set the source image to [Camera] or [Prev.].

Parameter	Setting	Description
Source image	Camera (camera image)	The filter is applied to the image that is taken by the Camera.
	Prev. (previous image)	The filter is applied to the image that resulted from the previous filter items or position compensation items in the processing order.

Setting the Region to Filter

You can specify the region to which to apply the filter.

This setting does not exist in the Color Gray Filter item.

► [Image] – [Image adjustment] – [Add filter] – (Filter item to select)

1 Press [◀] – [Filter region] on the right of the display.

2 Adjust the size and position of the region to which the filter is to be applied.

To fine-tune the region, press [◀] – [Console] on the right of the display to display the console.

This will allow you to change the coordinates of the rectangle at the pixel level.

Drag to move the region.

Drag a corner to size the rectangle.

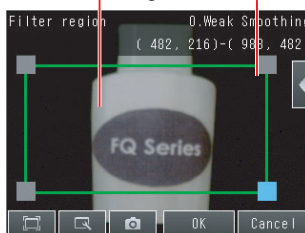

Setting the Filter Type (for Color Gray Filter Only)

You can specify the ranges of colors to which the Color Gray Filter item is applied.

► [Image] – [Image adjustment] – [Add filter] – [Color Gray Filter]

1 Press [◀] – [Filter type] on the right of the display.

2 Set the filter type to either [RGB] or [HSV].

Parameter	Description
RGB (Default)	The red, green, and blue extraction ranges are specified.
HSV	The extracted color ranges are specified with the hue and chroma (saturation).



3 Press [◀] – [Filter settings] on the right of the display.

4 Make the detailed filter settings.

- RGB

Select the type of color filter to use.

If you select [Custom filter], set the gains for red, green, and blue.



- HSV

Set the following ranges: [Std. Hue], [Hue range], and [Chroma].

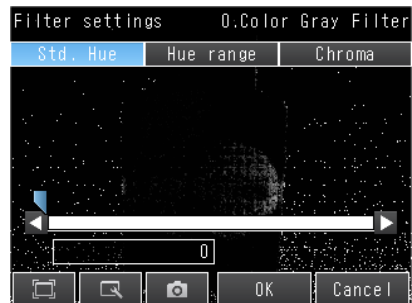

5 Press [OK].

6 Press [Back].

• RGB

Parameter	Setting	Description
Filter settings	<ul style="list-style-type: none">• Red filter (Default)• Green filter• Blue filter• Cyan filter• Magenta filter• Yellow filter• Brgt.F (brightness filter) (R+G+B)• Brgt.F (brightness filter) (R+2G+B)• Custom filter	These filters achieve the same effect as when using the selected optical filter.
R	Range: 0.0001 to 9.9999 Default: 0.3000	These are the RGB gain settings for a custom filter.
G	Range: 0.0001 to 9.9999 Default: 0.5900	Increase the gain to increase the density of that color component.
B	Range: 0.0001 to 9.9999 Default: 0.1100	You can set the gains only if [Custom filter] is selected in the filter settings.

• HSV

Parameter	Setting	Description
Std. Hue (standard hue)	Range: 0 to 359 Default: 0	Sets the standard hue for the HSV filter. The density will decrease as the difference between the hue and the standard hue increases.
Hue range	Range: 10 to 180 Default: 90	Sets the hue range for the HSV filter. The hue range centered on the standard hue is divided into 255 levels to find the difference in the hue. Hues that are outside the hue range will have a density of 0.
Chroma (saturation)	Range: 0 to 255 (Default)	Set the upper and lower limit values for the chroma (saturation).

Setting the Brightness Range to Extract (for Background Suppression Item Only)

The range in which to enhance the contrast and the brightness range to extract are set for the Background Suppression item. The Background Suppression item works as described below to suppress the background for the specified brightness range.

- Enhancing Contrast

The range of the input brightness that is within the specified brightness range (0 to 255) is converted to 255 levels to enhance the contrast.

- Background Suppression

Input values from 0 to the lower limit are converted to level 0 and input values between the upper limit and 255 are converted to level 255 to remove as the background any places that are not within the specified brightness range.

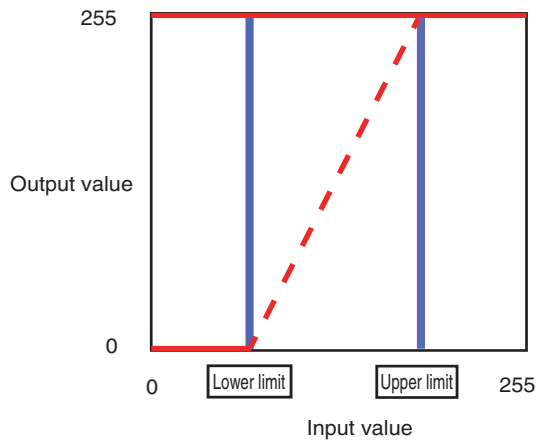

You can use either of the following methods to set the upper and lower limits of the brightness range to extract with the Background Suppression item.

• Enhancing the Contrast of a Specific Area

You specify the location on the image to enhance the contrast.

► [Image] – [Image adjustment] – [Background Suppression] – [Modify]

1 Press [◀] – [Suppression level] on the right of the display.

2 Drag on the image to specify the location to emphasize the contrast.

The contrast in the specified range will be reset to between 0 and 255.



3 Press [OK].

4 Press [Back].

• **Extracting Only a Specified Range of Brightness**

You set the upper and lower limits of the brightness range to extract with the Background Suppression item.

► **[Image] – [Image adjustment] – [Background suppression] – [Modify]**

- 1** Press [◀] – [Suppression level] on the right of the display.
- 2** Press [◀] – [RGB setting] on the right of the display.
- 3** Select the method to use to specify the brightness range. (This setting applies to Sensors with Color Cameras only.)

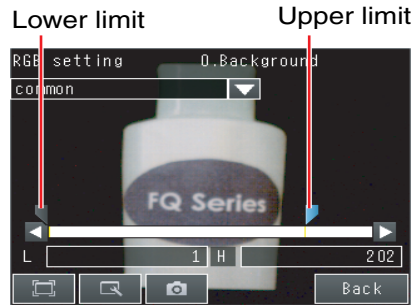

- **Common RGB Settings**
Set the upper and lower limit values of the brightness range. The same limits will be used for all RGB colors.
- **Individual RGB Settings**
Set the upper and lower limit values of the brightness range for each RGB color. Press [R], [G], and [B] and set the upper and lower limits for each of them.



- 4** Set the upper and lower limit values of the brightness range. (for Sensors with Monochrome Cameras (or after a Color Gray Filter))



- 5** Press [Back].
- 6** Press [OK].
- 7** Press [Back].

Parameter	Setting	Description
Common (common RGB setting)	Range: 0 to 255 (Default)	Set the upper and lower limit values of the background suppression level. The same limits will be used for all RGB colors. The range from the specified lower to upper limits is converted to 0 to 255.
Individual (individual RGB settings)	Range: 0 to 255 (Default)	Set the upper and lower limit values of the background suppression level for each RGB color. The range from the specified lower to upper limits is converted to 0 to 255.
Brightness range (for Sensors with Monochrome Cameras)	Range: 0 to 255 (Default)	The specified range is converted to 0 to 255.

Measurement Data That Can Be Used for External Outputs and Calculations

The following values can be used as measurement data and output to external devices via Ethernet or used in calculations. Measurement data can be specified for each filter item.

Expression text string	Data name	Description	Data range
JG	Judgement	This is the judgment result.	-2: No judgement (not measured) 0: Judgement is OK -1: Judgement is NG

Compensating for Position Offset (Position Compensation Items)

Use position compensation items if the position or orientation of the measurement object is not consistent. When you use a position compensation item, the offset between the reference position and the position of the object is calculated and the position of the measurement region is corrected before measurements are performed.

Applicable Position Compensation Items

There are three position compensation items as indicated below. These items vary by detection method.

Type	Description
Model (model position compensation)	<p>A search is made for a characteristic pattern to detect and correct the position.</p> <ul style="list-style-type: none">• Shape Sear III.pos.comp (Shape Search Position Compensation III)• Shape Sear. pos. comp. (Shape Search Position Compensation)• Search position comp. (Search Position Compensation)
Edge position comp. (edge position compensation)	<p>The color distribution or density changes in the object are used to detect and correct the position.</p> <ul style="list-style-type: none">• Edge position comp. (Edge Position Compensation)• 2Edge position comp. (Two-edge Position Compensation)• 2Edge midpoint comp. (Two-edge Midpoint Compensation)• Edge rot. pos. comp. (Edge Rotation Position Compensation)
Numerical position compensation	<p>Position is corrected based on entered value and image.</p> <p>Position comp. (Image rotation, Parameter)</p> <p>Linear correction</p>

• Features of the Position Compensation Items

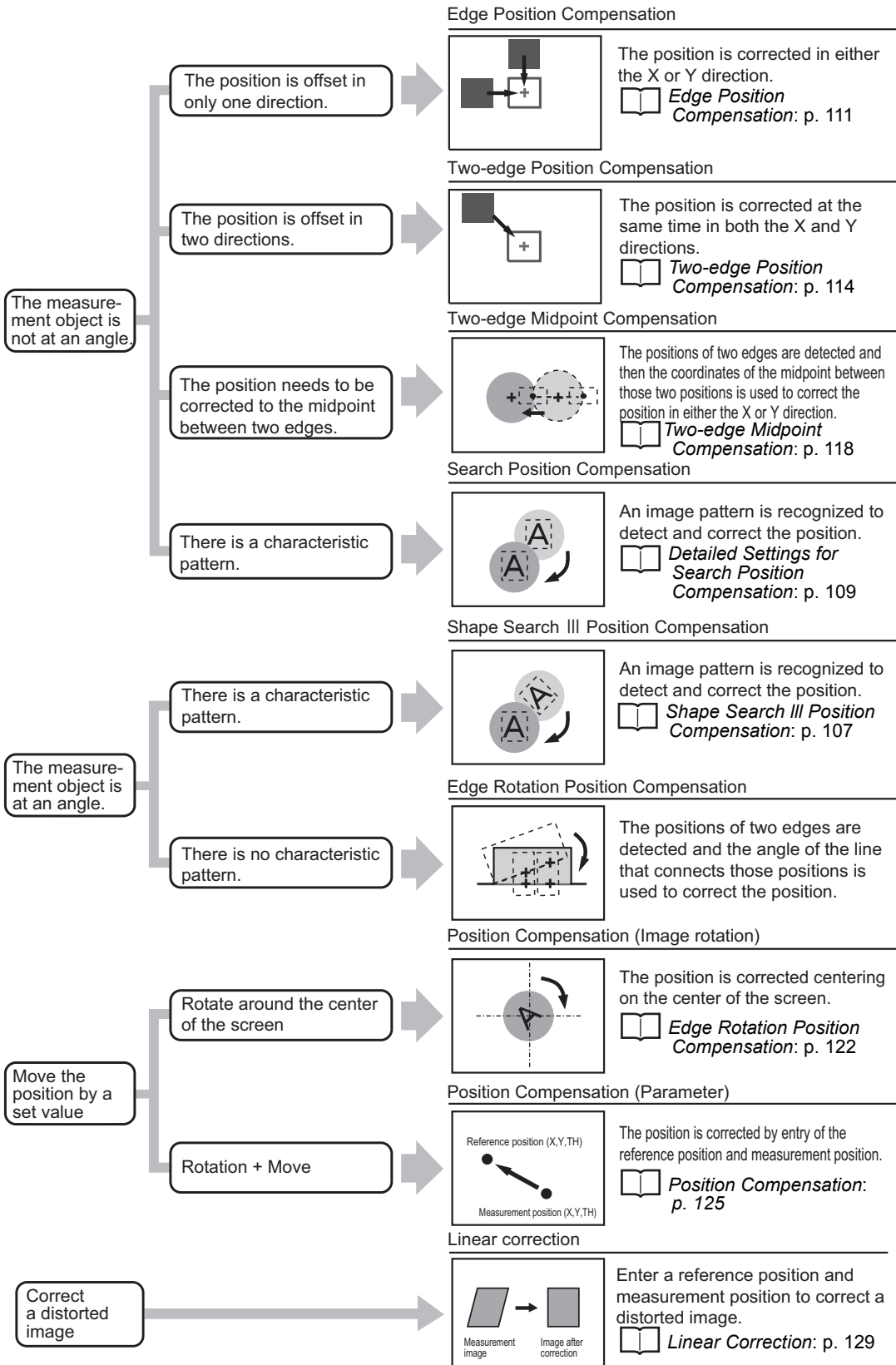

Applying the Results of Position Compensation

You can apply the results of position compensation either to the Camera image or to the previous image from before position compensation was applied.

If you apply the results of position compensation to the Camera image, only the position information from position compensation is applied to the image to be measured.

 *Using Filter Items for Processing with Position Compensation Items: p. 106*

• Setting the Image for Position Compensation

You can select the image to which to apply the results of position compensation processing.

You can set the image for position compensation for each position compensation item.

▶ **[Image] – [Image adjustment] – (Position compensation item name) – [Modify]**

1 Touch **[Details] – [Scroll parameter]**

2 Set the source image to **[Camera]** or **[Prev.]**.

Parameter	Setting	Description
Source image	Camera (Camera Image)	The results of processing the position compensation item is applied to the image that is taken by the Camera. This setting is used when filter items or other position compensation items have been used specifically for the position compensation item.  <i>Using Filter Items for Processing with Position Compensation Items: p. 106</i>
	Prev. (previous image) (default)	This setting is used when the processing results of the current position item are to be applied to the image that results from previous filter items or other position compensation items.

• Source Image

You can select the image to which to apply the results of position compensation processing.

 *Applying the Results of Position Compensation: p.104*

• Interpolation

You can select the precision of position compensation.

If you select [Bilinear], the precision of position compensation will increase.

▶ **[Image] – [Image adjustment] – [Search position comp.] – [Modify] – [Details]**
– [Scroll parameter] – [Interpolation]

1 Touch [Details] – [Scroll parameter] – [Shape pos. comp]

2 Select [Bilinear] or [None].

Parameter	Setting	Description
Interpolation	Bilinear	Connects the points with a line and calculates an approximate value, Although, the processing time will be longer, a smooth image can be acquired when you select [Bilinear],
	None (Default)	Image correlation is executed by a pixel.

• Using Filter Items for Processing with Position Compensation Items

To more effectively perform position compensation, filter items can be used to create an image specifically for position compensation and then apply only the results of processing the position compensation to the image that will be measured.

The processing order of filter and position compensation items and the settings of the source images are set up as shown below.

Processing order	Image processing item	Source image setting
1	0: Enhance edges (Edge Enhancement) (filter item)	Source image: Camera image Camera image (image for processing) → Processed image (results of processing)
2	1: Search position comp. (Search Position Compensation) (position compensation item)	Source image: Camera image Previous image (image for processing) → Camera image (results of processing)

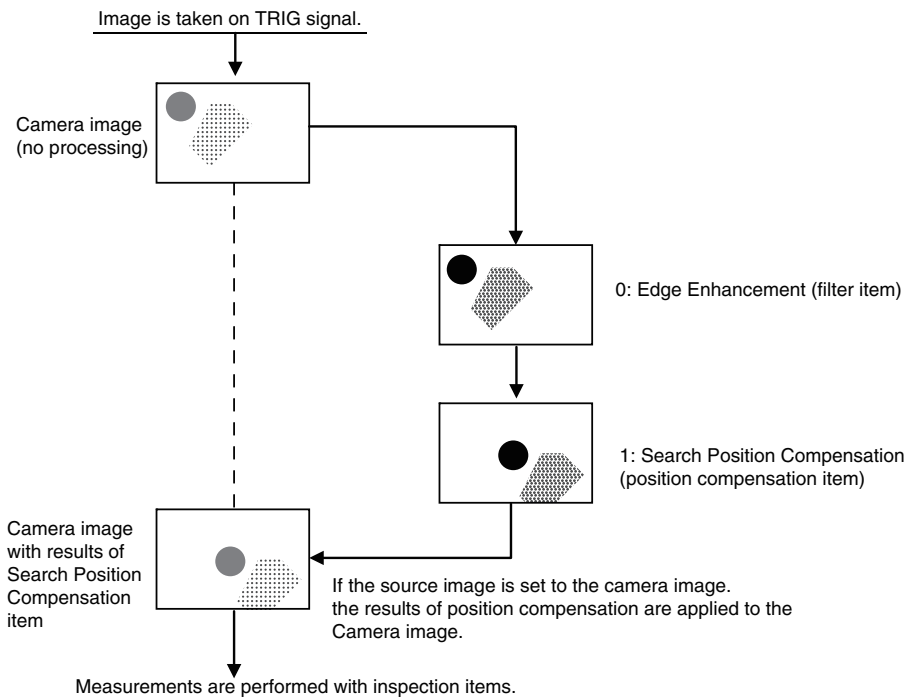

Shape Search III Position Compensation

With this position compensation item, an image pattern is registered in advance. When the registered image pattern is detected, the image is adjusted so that the image pattern is in the same position as when it was registered.

This position compensation item performs the same type of processing as the Search Position Compensation item, but it performs special processing for the shape of the image pattern.

Use this position compensation item to correct the position of a rotated image pattern.

► [Image] – [Image adjustment]

1 Press an unused number and then press [Add pos. comp.].

2 Press [Model] – [Shape III. pos. comp.]

3 Make any detailed settings as required for the position compensation processing.

Refer to *Detailed Settings for Shape Search III Position Compensation*, below.

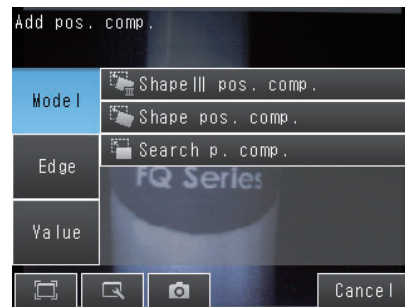

4 Press [OK].

5 Press [Back].

• Detailed Settings for Shape Search Position Compensation

The settings for the Shape Search III Position Compensation item are almost the same as those for the Shape Search II inspection item. Only the [Sorting method] settings of the Search item are not included in the settings of the Shape Search Position Compensation item.

Configure the settings for teaching and the judgment conditions in the same way as for the Shape Search II item.

☐ 4-9 *Inspecting with the Shape Search III Inspection Item: p. 230*

Also, the following settings are included only in the Shape Search III Position Compensation Item.

• Source Image

You can select the image to which to apply the results of position compensation processing.

☐ *Applying the Results of Position Compensation: p. 104*

• Interpolation

You can select the precision of position compensation.

If you select [Bilinear], the precision of position compensation will increase.

► [Image] – [Image adjustment] – [Search III pos. comp.] – [Modify]

1 Press [Details] – [Scroll parameter] – [Interpolation]

2 Set the interpolation to [Bilinear] or [None].

Parameter	Setting	Description
Interpolation	Bilinear	Connects the points with a line and calculates an approximate value. Although, the processing time will be longer, a smooth image can be acquired when you select [Bilinear],
	None (Default)	Position compensation is performed at the pixel level.

• Measurement Data That Can Be Used for External Outputs and Calculations

The following values can be used as measurement data and output to external devices via Ethernet or used in calculations.

Expression text string	Data name	Description	Data range
JG	Judgement	This is the judgement result.	-2: No judgement (not measured) 0: Judgement is OK -1: Judgement is NG -10: Image inconsistency error -15: Out of range error
DX	Scroll X	This is the amount of position compensation for the X coordinate.	-99,999.9999 to 99,999.9999
DY	Scroll Y	This is the amount of position compensation for the Y coordinate.	-99,999.9999 to 99,999.9999
DT	Scroll q	This is the amount of angular compensation, q.	-180 to 180
X	Position X	This is the X coordinate of the position where the model was found.	-99,999.9999 to 99,999.9999
Y	Position Y	This is the Y coordinate of the position where the model was found.	-99,999.9999 to 99,999.9999
TH	Angle	This is the angle at which the model was found.	-180 to 180
SX	Reference X	This is the X coordinate of the position where the model was registered.	-99,999.9999 to 99,999.9999
SY	Reference Y	This is the Y coordinate of the position where the model was registered.	-99,999.9999 to 99,999.9999
ST	Reference angle	This is the angle when the model was registered.	-180 to 180

Expression text string	Data name	Description	Data range
CR	Correlation	This is the correlation.	0 to 100

• Measurement Data That Can Be Logged

The values below can be logged as measurement data.

Parameter	Setting	Description
Judgement	-2: No judgement (not measured) 0: Judgement is OK -1: Judgement is NG	This is the judgment result.
Scroll X	-99,999.9999 to 99,999.9999	This is the amount of position compensation for the X coordinate.
Scroll Y	-99,999.9999 to 99,999.9999	This is the amount of position compensation for the Y coordinate.
Scroll q	-180 to 180	This is the amount of angular compensation, q.
Correlation	0 to 100	This is the correlation.
Position X	-99,999.9999 to 99,999.9999	This is the X coordinate of the position where the model was found.
Position Y	-99,999.9999 to 99,999.9999	This is the Y coordinate of the position where the model was found.
Angle	-180 to 180	This is the angle at which the model was found.

Detailed Settings for Search Position Compensation

The settings for the Search Position Compensation item are almost the same as those for the Search inspection item. (The [Multi-point output] and model parameter settings of the Search inspection item are not included in the Search Position Compensation settings.) Make the settings for teaching and the judgment conditions in the same way as for the Search item.

 *Inspecting with the Shape Search II Inspection Item: p.215*

Also, the following settings are included only in the Search Position Compensation Item.

• Source Image

You can select the image to which to apply the results of position compensation processing.

 *Applying the Results of Position Compensation: p.104*

• Interpolation

Select the image to reflect the results of Interpolation processing to.

If you select [Bilinear], the precision of position compensation will increase.

► [Image] – [Image adjustment] – [Search position comp.] – [Modify] – [Details] – [Scroll parameter] – [Interpolation]

1 Press [Details] – [Scroll parameter] – [Interpolation]

2 Set the interpolation to [Bilinear] or [None].

Parameter	Setting	Description
Interpolation	Bilinear	Connects the points with a line and calculates an approximate value. Although, the processing time will be longer, a smooth image can be acquired when you select [Bilinear],
	None (Default)	Position compensation is performed at the pixel level.

• Measurement Data That Can Be Used for External Outputs and Calculations

The following values can be used as measurement data and output to external devices via Ethernet or used in calculations.

Expression text string	Data name	Description	Data range
JG	Judgement	-2: No judgement (not measured) 0: Judgement is OK -1: Judgement is NG -10: Image error -15: Out of range error	This is the judgment result.
DX	Scroll X	-99,999.9999 to 99,999.9999	This is the amount of position compensation for the X coordinate.
DY	Scroll Y	-99,999.9999 to 99,999.9999	This is the amount of position compensation for the Y coordinate.
X	Position X	-99,999.9999 to 99,999.9999	This is the X coordinate of the position where the model was found.
Y	Position Y	-99,999.9999 to 99,999.9999	This is the Y coordinate of the position where the model was found.
SX	Reference X	-99,999.9999 to 99,999.9999	This is the X coordinate of the position where the model was registered.
SY	Reference Y	-99,999.9999 to 99,999.9999	This is the Y coordinate of the position where the model was registered.
CR	Correlation	0 to 100	This is the correlation.

• Measurement Data That Can Be Logged

The values below can be logged as measurement data.

Parameter	Setting	Description
Judgement	-2: No judgement (not measured) 0: Judgement is OK -1: Judgement is NG -15: Out of range error	This is the judgment result.
Scroll X	-99,999.9999 to 99,999.9999	This is the amount of position compensation for the X coordinate.
Scroll Y	-99,999.9999 to 99,999.9999	This is the amount of position compensation for the Y coordinate.
Correlation	0 to 100	This is the correlation.
Position X	-99,999.9999 to 99,999.9999	This is the X coordinate of the position where the model was found.
Position Y	-99,999.9999 to 99,999.9999	This is the Y coordinate of the position where the model was found.

Edge Position Compensation

This position compensation item detects an edge in the set direction.

If the specified color is detected (or the specified density is detected for a Sensor with a Monochrome Camera), it is recognized as an edge.

When an edge is recognized, the image is adjusted so that the edge appears at the position it was in when it was registered.

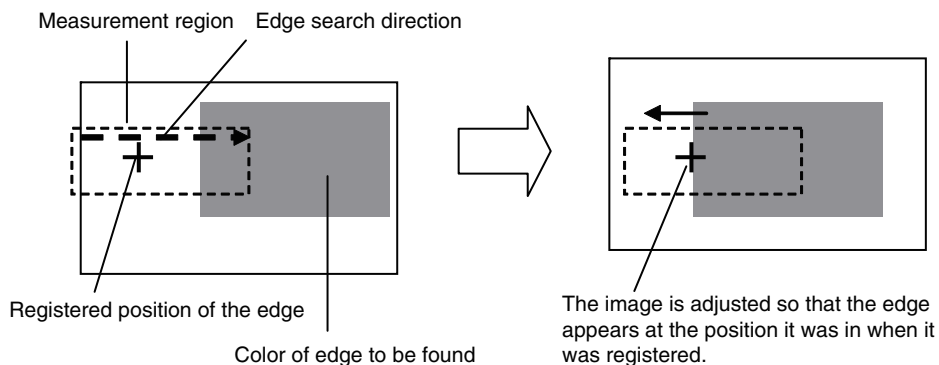

► **[Image] – [Image adjustment]**

- 1** Press an unused number and then press [Add pos. comp.].
- 2** Press [Edge] – [Edge position comp.].
- 3** Make any detailed settings as required for the position compensation processing.
Refer to *Detailed Settings for Edge Position Compensation*, below.
- 4** Press [OK].
- 5** Press [Back].

• **Detailed Settings for Edge Position Compensation**

The settings for the Edge Position Compensation item are almost the same as those for the Edge Position inspection item.

Make the settings for teaching and the judgment conditions in the same way as for the Edge Position inspection item.

☐ *4-12 Inspecting with the Edge Position Inspection Item: p. 271*

However, the following settings are included only in the Edge Position Compensation Item.

• **Source Image**

You can select the image to which to apply the results of position compensation processing.

☐ *Applying the Results of Position Compensation: p.104*

• **Interpolation**

You can select the precision of position compensation.

If you select [Bilinear], the precision of position compensation will increase.

► **[Image] – [Image adjustment] – [Edge position comp.] – [Modify] – [Details] - [Scroll parameter] – [Interpolation]**

The settings are the same as those for the Shape Search Position Compensation item.

☐ *Interpolation: p. 108*

• Measurement Data That Can Be Used for External Outputs and Calculations

The following values can be used as measurement data and output to external devices via Ethernet or used in calculations.

Expression text string	Data name	Description	Data range
JG	Judgement	This is the judgement result.	-2: No judgement (not measured) 0: Judgement is OK -1: Judgement is NG
DX	Scroll X	This is the amount of position compensation for the X coordinate.	-99,999.9999 to 99,999.9999
DY	Scroll Y	This is the amount of position compensation for the Y coordinate.	-99,999.9999 to 99,999.9999
X	Position X (edge position X)	This is the X coordinate of the measured edge position.	-99,999.9999 to 99,999.9999
Y	Position Y (edge position Y)	This is the Y coordinate of the measured edge position.	-99,999.9999 to 99,999.9999
SX	Reference X	This is the X coordinate of the edge position when it was registered.	-99,999.9999 to 99,999.9999
SY	Reference Y	This is the Y coordinate of the edge position when it was registered.	-99,999.9999 to 99,999.9999

• Measurement Data That Can Be Logged

The values below can be logged as measurement data.

Parameter	Setting	Description
Judgement	-2: No judgement (not measured) 0: Judgement is OK -1: Judgement is NG	This is the judgment result.
Scroll X	-99,999.9999 to 99,999.9999	This is the amount of position compensation for the X coordinate.
Scroll Y	-99,999.9999 to 99,999.9999	This is the amount of position compensation for the Y coordinate.
Position X (edge position X)	-99,999.9999 to 99,999.9999	This is the X coordinate of the measured edge position.
Position Y (edge position Y)	-99,999.9999 to 99,999.9999	This is the Y coordinate of the measured edge position.

Two-edge Position Compensation

This position compensation item detects edges in two directions.

If the specified color is detected (or the specified density is detected for a Sensor with a Monochrome Camera), it is recognized as an edge.

When an edge is recognized, the image is adjusted so that the edge appears at the position it was in when it was registered.

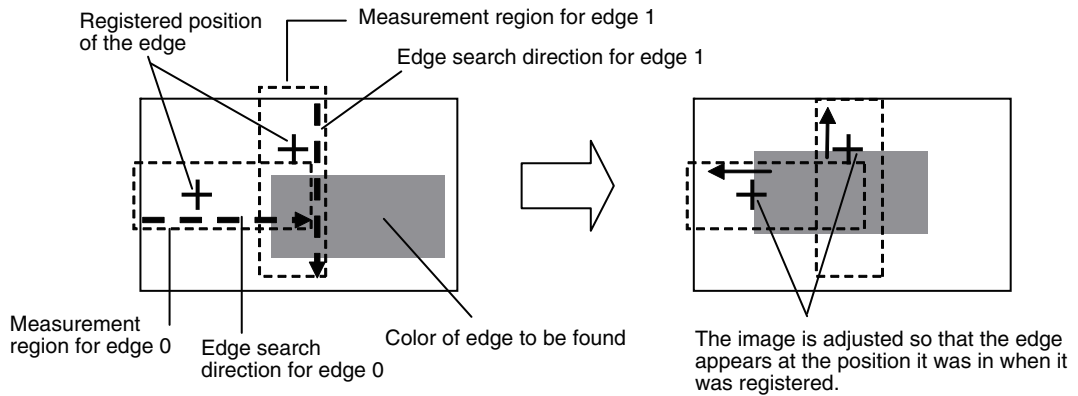

► [Image] – [Image adjustment]

- 1** Press an unused number and then press [Add pos. comp.].
- 2** Press [Edge] – [2Edge position comp.].
- 3** Make any detailed settings as required for the position compensation processing.
Refer to *Detailed Settings for Two-edge Position Compensation*, below.
- 4** Press [OK].
- 5** Press [Back].

• Detailed Settings for Two-edge Position Compensation

The settings for the Two-edge Position Compensation item are almost the same as those for the Edge Position inspection item.

Make the settings in the same way as for the Edge Position inspection item.

 4-12 *Inspecting with the Edge Position Inspection Item*: p. 271

However, the following settings are included only in the Edge Position Compensation Item.

• Teaching

Set the measurement regions and measurement directions for both edge 0 and edge 1.

► [Image] – [Image adjustment] – [2Edge position comp.] – [Modify] – [Basic]

- 1 Press [Teach].
- 2 Place the object that is to be used as the measurement reference in front of the camera.
- 3 Move the rectangle to the location to be measured, and then press [OK].

This concludes setting the measurement region and edge search direction for edge 0.

Next, go to step 4 to set the measurement region and edge search direction for edge 1.

- 4 Press [] – [Edge1 region] on the right of the display, move the rectangle to the location to be measured, and then press [OK].

- 5 Press [TEACH] on the lower right of the display.

The basic settings will be registered when teaching has been completed.

- 6 Press [Back] to end teaching.

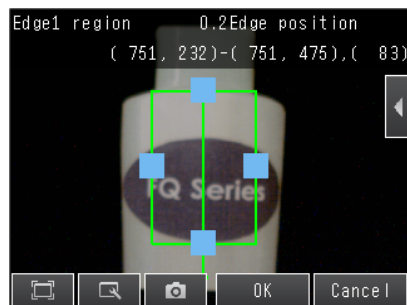
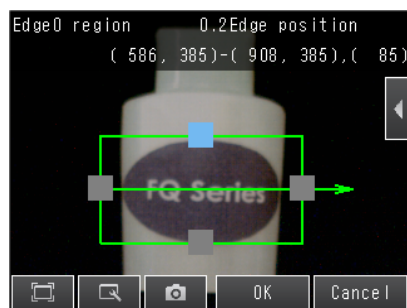

• Source Image

You can select the image to which to apply the results of position compensation processing.

 *Applying the Results of Position Compensation: p. 104*

• Interpolation

You can select the precision of position compensation.

If you select [Bilinear], the precision of position compensation will increase.

▶ [Image] – [Image adjustment] – [2Edge position comp.] – [Modify] – [Details] – [Interpolation]

The settings are the same as those for the Shape Search Position Compensation item.

 *Interpolation: p. 108*

• Measurement Data That Can Be Used for External Outputs and Calculations

The following values can be used as measurement data and output to external devices via Ethernet or used in calculations.

Expression text string	Data name	Description	Data range
JG	Judgement	This is the judgement result.	-2: No judgement (not measured) 0: Judgement is OK -1: Judgement is NG -15: Out of range error
DX	Scroll X	This is the amount of position compensation for the X coordinate.	-99,999.9999 to 99,999.9999
DY	Scroll Y	This is the amount of position compensation for the Y coordinate.	-99,999.9999 to 99,999.9999
X0	Edge 0 position X	This is the X coordinate of the measured edge 0 position.	-99,999.9999 to 99,999.9999
Y0	Edge 0 position Y	This is the Y coordinate of the measured edge 0 position.	-99,999.9999 to 99,999.9999
X1	Edge 1 position X	This is the X coordinate of the measured edge 1 position.	-99,999.9999 to 99,999.9999
Y1	Edge 1 position Y	This is the Y coordinate of the measured edge 1 position.	-99,999.9999 to 99,999.9999
SX0	Edge0 ref. position X (edge 0 reference position X)	This is the X coordinate of the edge 0 position when it was registered.	-99,999.9999 to 99,999.9999
SY0	Edge0 ref. position Y (edge 0 reference position Y)	This is the Y coordinate of the edge 0 position when it was registered.	-99,999.9999 to 99,999.9999
SX1	Edge1 ref. position X (edge 1 reference position X)	This is the X coordinate of the edge 1 position when it was registered.	-99,999.9999 to 99,999.9999
SY1	Edge1 ref. position Y (edge 1 reference position Y)	This is the Y coordinate of the edge 1 position when it was registered.	-99,999.9999 to 99,999.9999

• **Measurement Data That Can Be Logged**

The values below can be logged as measurement data.

Parameter	Setting	Description
Judgement	-2: No judgement (not measured) 0: Judgement is OK -1: Judgement is NG -15: Out of range error	This is the judgement result.
Scroll X	-99,999.9999 to 99,999.9999	This is the amount of position compensation for the X coordinate.
Scroll Y	-99,999.9999 to 99,999.9999	This is the amount of position compensation for the Y coordinate.
Edge 0 position X	-99,999.9999 to 99,999.9999	This is the X coordinate of the measured edge 0 position.
Edge 0 position Y	-99,999.9999 to 99,999.9999	This is the Y coordinate of the measured edge 0 position.
Edge 1 position X	-99,999.9999 to 99,999.9999	This is the X coordinate of the measured edge 1 position.
Edge 1 position Y	-99,999.9999 to 99,999.9999	This is the Y coordinate of the measured edge 1 position.

Two-edge Midpoint Compensation

This position compensation item detects edges in two directions.

If the specified color is detected (or the specified density is detected for a Sensor with a Monochrome Camera), it is recognized as an edge. Two edge positions are detected.

The image is adjusted so that the coordinates of the midpoint position of a line that connects the two detected edge positions matches the position when the edges were registered.

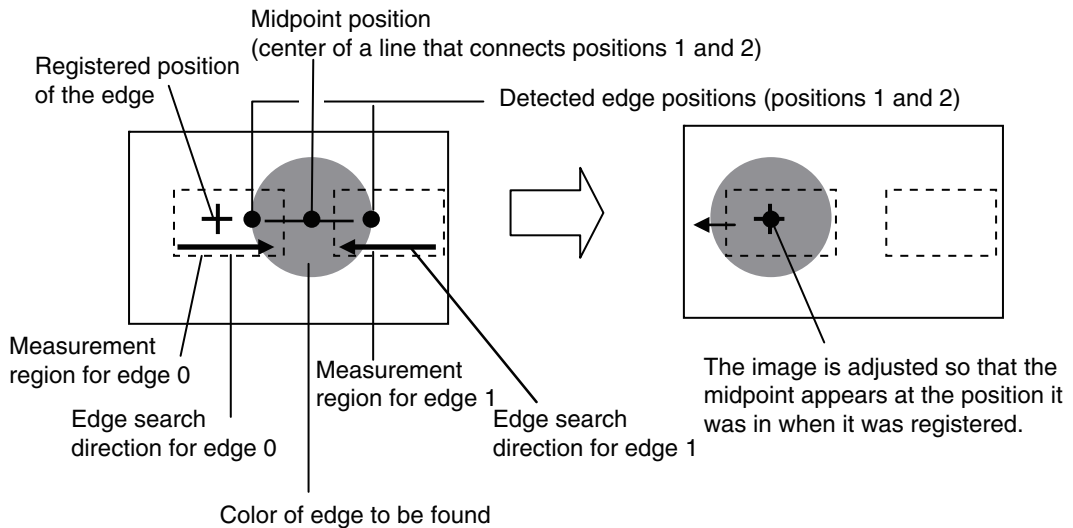

► [Image] – [Image adjustment]

- 1** Press an unused number and then press [Add pos. comp.].
- 2** Press [Edge] – [2Edge midpoint comp.].
- 3** Make any detailed settings as required for the position compensation processing.
Refer to *Detailed Settings for Two-edge Midpoint Compensation*, below.
- 4** Press [OK].
- 5** Press [Back].

• Detailed Settings for Two-edge Midpoint Compensation

The settings for the Two-edge Midpoint Compensation item are almost the same as those for the Edge Position inspection item.

Make the settings in the same way as for the Edge Position inspection item.

 *4-12 Inspecting with the Edge Position Inspection Item: p. 271*

However, the following settings are included only in the Edge Position Compensation Item.

• Teaching

Set the measurement regions and measurement directions for both edge 0 and edge 1.

▶ **[Image] – [Image adjustment] – [2Edge midpoint comp.] – [Modify] – [Basic] – [Teach]**

The settings are the same as those for the Two-edge Position Compensation item.

 *Teaching: p. 115*

• Source Image

You can select the image to which to apply the results of position compensation processing.

 *Applying the Results of Position Compensation: p. 104*

• Interpolation

You can select the precision of position compensation.

If you select [Bilinear], the precision of position compensation will increase.

▶ **[Image] – [Image adjustment] – [2ed. midp. comp.] – [Modify] – [Details] – [Scroll parameter] – [Interpolation]**

The settings are the same as those for the Shape Search Position Compensation item.

 *Interpolation: p. 108*

• Measurement Data That Can Be Used for External Outputs and Calculations

The following values can be used as measurement data and output to external devices via Ethernet or used in calculations.

Expression text string	Data name	Description	Data range
JG	Judgement	This is the judgement result.	-2: No judgement (not measured) 0: Judgement is OK -1: Judgement is NG -15: Out of range error
DX	Scroll X	This is the amount of position compensation for the X coordinate.	-99,999.9999 to 99,999.9999
DY	Scroll Y	This is the amount of position compensation for the Y coordinate.	-99,999.9999 to 99,999.9999
X0	Edge 0 position X	This is the X coordinate of the measured edge 0 position.	-99,999.9999 to 99,999.9999
Y0	Edge 0 position Y	This is the Y coordinate of the measured edge 0 position.	-99,999.9999 to 99,999.9999
X1	Edge 1 position X	This is the X coordinate of the measured edge 1 position.	-99,999.9999 to 99,999.9999
Y1	Edge 1 position Y	This is the Y coordinate of the measured edge 1 position.	-99,999.9999 to 99,999.9999
MX	Midpoint X	This is the X coordinate of the measured edge midpoint position.	-99,999.9999 to 99,999.999
MY	Midpoint Y	This is the Y coordinate of the measured edge midpoint position.	-99,999.9999 to 99,999.999
SX0	Edge0 ref. position X (edge 0 reference position X)	This is the X coordinate of the edge 0 position when it was registered.	-99,999.9999 to 99,999.9999
SY0	Edge0 ref. position Y (edge 0 reference position Y)	This is the Y coordinate of the edge 0 position when it was registered.	-99,999.9999 to 99,999.9999
SX1	Edge1 ref. position X (edge 1 reference position X)	This is the X coordinate of the edge 1 position when it was registered.	-99,999.9999 to 99,999.9999
SY1	Edge1 ref. position Y (edge 1 reference position Y)	This is the Y coordinate of the edge 1 position when it was registered.	-99,999.9999 to 99,999.9999
SMX	Ref. Midpoint X (reference midpoint X)	This is the X coordinate of the midpoint of the two edges when they were registered.	-9,999.9999 to 99,999.9999
SMY	Ref. Midpoint Y (reference midpoint Y)	This is the Y coordinate of the midpoint of the two edges when they were registered.	-9,999.9999 to 99,999.9999

• **Measurement Data That Can Be Logged**

The values below can be logged as measurement data.

Parameter	Setting	Description
Judgement	-2: No judgement (not measured) 0: Judgement is OK -1: Judgement is NG -15: Out of range error	This is the judgement result.
Scroll X	-99,999.9999 to 99,999.9999	This is the amount of position compensation for the X coordinate.
Scroll Y	-99,999.9999 to 99,999.9999	This is the amount of position compensation for the Y coordinate.
Midpoint X	-99,999.9999 to 99,999.999	This is the X coordinate of the measured edge midpoint position.
Midpoint Y	-99,999.9999 to 99,999.999	This is the Y coordinate of the measured edge midpoint position.
Edge 0 position X	-99,999.9999 to 99,999.9999	This is the X coordinate of the measured edge 0 position.
Edge 0 position Y	-99,999.9999 to 99,999.9999	This is the Y coordinate of the measured edge 0 position.
Edge 1 position X	-99,999.9999 to 99,999.9999	This is the X coordinate of the measured edge 1 position.
Edge 1 position Y	-99,999.9999 to 99,999.9999	This is the Y coordinate of the measured edge 1 position.

Edge Rotation Position Compensation

This position compensation item detects an edge in two directions.

If the specified color is detected (or the specified density is detected for a Sensor with a Monochrome Camera), it is recognized as an edge. Two edge positions are detected.

The image is adjusted so that the two edge positions match the positions when the edge positions were registered.

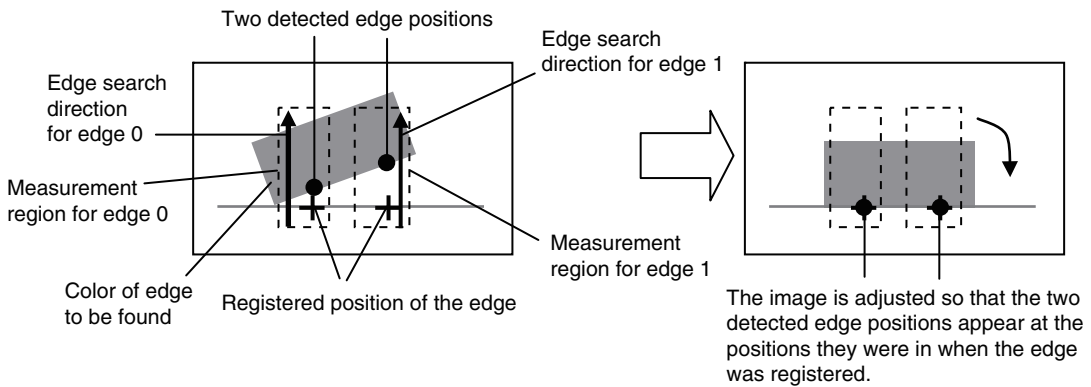

► [Image] – [Image adjustment]

- 1** Press an unused number and then press [Add pos. comp.].
- 2** Press [Edge] – [Edge rot. pos. Comp.]
- 3** Make any detailed settings as required for the position compensation processing.
Refer to *Detailed Settings for Edge Rotation Position Compensation*, below.
- 4** Press [OK].
- 5** Press [Back].

• Detailed Settings for Edge Rotation Position Compensation

The settings for the Edge Rotation Position Compensation item are almost the same as those for the Edge Position inspection item.

Make the settings in the same way as for the Edge Position inspection item.

 *4-12 Inspecting with the Edge Position Inspection Item: p. 271*

However, the following settings are included only in the Edge Position Compensation Item.

• Teaching

- Measurement Regions and Measurement Directions

Set the measurement regions and measurement directions for both edge 0 and edge 1.

▶ **[Image] – [Image adjustment] – [Edge rot. pos. Comp.] – [Modify] – [Basic] – [Teach]**

The settings are the same as those for the Two-edge Position Compensation item.

 *Teaching: p. 115*

• Reference Angle

Set the reference angle.

Press [] – [Edit Ref. angle] on the right of the display and set the angle.

• Source Image

You can select the image to which to apply the results of position compensation processing.

 *Applying the Results of Position Compensation: p.104*

• Interpolation

You can select the precision of position compensation.

If you select [Bilinear], the precision of position compensation will increase.

▶ **[Image] – [Image adjustment] – [2Edge position comp.] – [Modify] – [Details] – [Interpolation]**

The settings are the same as those for the Shape Search Position Compensation item.

 *Interpolation: p. 108*

• **Measurement Data That Can Be Used for External Outputs and Calculations**

The following values can be used as measurement data and output to external devices via Ethernet or used in calculations.

Expression text string	Data name	Description	Data range
JG	Judgement	This is the judgment result.	-2: No judgement (not measured) 0: Judgement is OK -1: Judgement is NG -15: Out of range error
DT	Scroll q	This is the amount of position compensation.	-180 to 180
X0	Edge 0 position X	This is the X coordinate of the measured edge 0 position.	-99,999.9999 to 99,999.9999
Y0	Edge 0 position Y	This is the Y coordinate of the measured edge 0 position.	-99,999.9999 to 99,999.9999
X1	Edge 1 position X	This is the X coordinate of the measured edge 1 position.	-99,999.9999 to 99,999.9999
Y1	Edge 1 position Y	This is the Y coordinate of the measured edge 1 position.	-99,999.9999 to 99,999.9999
TH	Angle (edge angle)	This is the measured angle.	-180 to 180
SX0	Edg0 ref. pos. (edge 0 reference position X)	This is the X coordinate of the edge 0 position when it was registered.	-99,999.9999 to 99,999.9999
SY0	Edg0 ref. pos. Y (edge 0 reference position Y)	This is the Y coordinate of the edge 0 position when it was registered.	-99,999.9999 to 99,999.9999
SX1	Edg1 ref. pos. X (edge 1 reference position X)	This is the X coordinate of the edge 1 position when it was registered.	-99,999.9999 to 99,999.9999
SY1	Edg1 ref. pos. Y (edge 1 reference position Y)	This is the Y coordinate of the edge 1 position when it was registered.	-99,999.9999 to 99,999.9999
STH	Reference angle	This is the angle when the edge was registered.	-180 to 180

• Measurement Data That Can Be Logged

The values below can be logged as measurement data.

Parameter	Setting	Description
Judgement	-2: No judgement (not measured) 0: Judgement is OK -1: Judgement is NG -15: Out of range error	This is the judgement result.
Scroll q	-180 to 180	This is the amount of position compensation.
Angle (edge angle)	-180 to 180	This is the measured angle.
Edge 0 position X	-99,999.9999 to 99,999.9999	This is the X coordinate of the measured edge 0 position.
Edge 0 position Y	-99,999.9999 to 99,999.9999	This is the Y coordinate of the measured edge 0 position.
Edge 1 position X	-99,999.9999 to 99,999.9999	This is the X coordinate of the measured edge 1 position.
Edge 1 position Y	-99,999.9999 to 99,999.9999	This is the Y coordinate of the measured edge 1 position.

Position Compensation

The position is corrected based on the entered numeric values.

This is used to correct the position by rotating the captured image around the center of the screen or entering numeric values.

► [Image] – [Image adjustment]

- 1 Press a free number, and press [Add pos. comp.].
- 2 Press [Value] – [Position comp.]

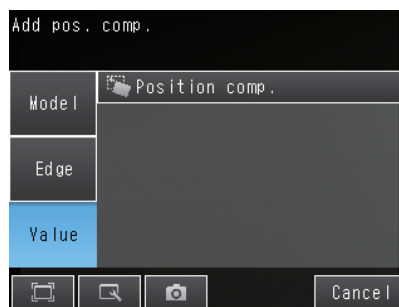

- 3 At the right of the screen, press  – [Image rotation] or [Parameter] to open the settings screen.

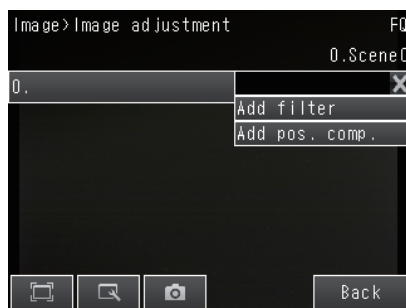

Parameter	Setting	Description
Position Compensation	Image rotation	Select to correct the position by rotating the image around the center of the screen.
	Parameter	Select to specify the amount of position compensation from the reference position and the measurement position. The displacement between the measurement position and the reference position is the amount of the position compensation.

When [Image rotation] is selected

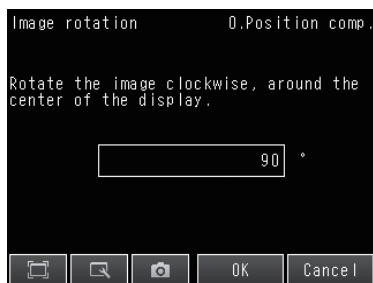

When [Parameter] is selected

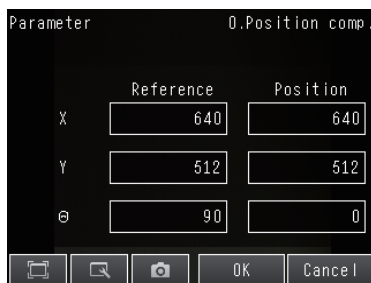

Parameter		Setting	Description
Angle		Range: -180 to 180 Default: 90	Rotates the image clockwise around the center of the screen. To rotate 90° counterclockwise, enter -90.
Reference position [Reference]	X	Range: -99,999 to 99,999 Defaults: 376 on the FQ2-S1***** FQ2-S2***** FQ2-S4***** FQ2-S4*****-M FQ2-CH 640 on the FQ2-S3*****08* FQ2-S4*****-08* FQ2-S3*-13* FQ2-S4*-13*	Sets the reference position.
	Y	Range: -99,999 to 99,999 Defaults: 240 on the FQ2-S1***** FQ2-S2***** FQ2-S4***** FQ2-S4*****M FQ2-CH 512 on the FQ2-S3*****08* FQ2-S4*****-08* FQ2-S3*-13* FQ2-S4*-13*	
	q	Range: -180 to 180 Default: 90	

Parameter		Setting	Description
Measurement position [Position]	X	Range: -99,999 to 99,999 Defaults: 376 on the FQ2-S1***** FQ2-S2***** FQ2-S4***** FQ2-S4*****-M FQ2-CH 640 on the FQ2-S3*****-08* FQ2-S4*****-08* FQ2-S3*-13* FQ2-S4*-13*	Sets the measurement position.
	Y	Range: -99,999 to 99,999 Defaults: 240 on the FQ2-S1***** FQ2-S2***** FQ2-S4***** FQ2-S4*****-M FQ2-CH 512 on the FQ2-S3*****08 FQ2-S4*****-08* FQ2-S3*-13* FQ2-S4*-13*	
	q	Range: -180 to 180 Default: 0	

4 Press [OK].

5 Press [Finish].

• Measurement Data That Can Be Used for External Outputs and Calculations

The following values can be used as measurement data and output to external devices via the Ethernet or used in calculations.

Expression text string	Data name	Description	Data range
JG	Judgement	This is the judgement result.	-2: No judgement (not measured) 0: Judgement is OK -1: Judgement is NG -15: Out of range error
DX	Position correction X	Amount of correction of X coordinate of position	-99,999.9999 to 99,999.9999
DY	Position correction Y	Amount of correction of Y coordinate of position	-99,999.9999 to 99,999.9999
DT	Position correction q	Amount of angle correction q	-180 to 180
X	Measurement coordinate X	X coordinate of measurement position	-99,999.9999 to 99,999.9999
Y	Measurement coordinate Y	Y coordinate of measurement position	-99,999.9999 to 99,999.9999
TH	Measurement angle	Angle of measurement position	-180 to 180
SX	Reference coordinate X	X coordinate of reference position	-99,999.9999 to 99,999.9999
SY	Reference coordinate Y	Y coordinate of reference position	-99,999.9999 to 99,999.9999
ST	Reference angle	Angle of reference position	-180 to 180

Linear Correction

When the measurement object is distorted because it is an angle to the camera, you can correct the input image.

► [Image] – [Image adjustment]

- 1 Press an unused number and then press [Add pos. comp.].

2 Press [Value] – [Linear Corr.].



3 Press [◀] – [Meas. position] at the right of the screen to open the settings screen.



4 Drag the vertices of the displayed figure to set the points to be used for correction.



5 Press [OK].

6 Press [◀] – [Ref. position] at the right of the screen to open the settings screen.

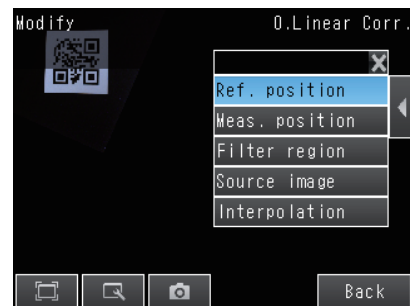

- 7 Set to the same settings as the measurement position settings, and drag the vertices of the displayed figure to bring the measurement position that you just set to the correct position.

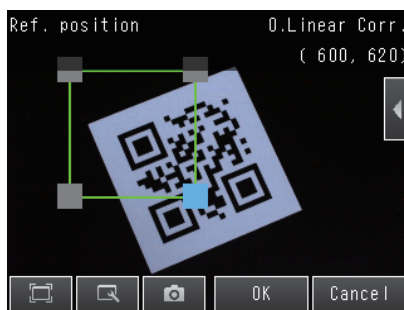

- 8 Press [OK].

- 9 Press [Back].

• Edit Region

You can set the range for position correction.

- ▶ [Image] – [Filter adjustment] – [Linear Corr.] – [Modify]

- 1 Press [◀] – [Filter region] at the right of the screen.
- 2 Adjust the size and position of the region for position correction.
To perform fine adjustment, press [◀◀] – [Console] at the right of the screen to open the fine adjustment console. The coordinate values of the frame can be moved in increments of one pixel.
- 3 Press [OK].

• Source Image

You can select the image to which to apply the results of position compensation processing.
You can set the image for position compensation for each position compensation item.

▶ [Image] – [Image adjustment] – [Linear Corr.] – [Modify]

1 Press [◀] – [Source image] at the right of the screen.

2 For the source image, select [Camera] or [Prev. image].

Parameter	Setting	Description
Source image	Camera	The results of processing the position compensation item is applied to the image that is taken by the Camera. This setting is used when filter items or other position compensation items have been used specifically for the position compensation item.
	Prev. (Default)	This setting is used when the processing results of the current position item are to be applied to the image that results from previous filter items or other position compensation items.

• Position Interpolation

You can select the precision of position compensation.
If you select [Bilinear], the precision of position compensation will increase.

▶ [Image] – [Image adjustment] – [Linear Corr.] – [Modify]

1 Press [◀] – [Interpolation] at the right of the screen.

2 Select [Bilinear] or [None] for position interpolation.

Parameter	Setting	Description
Interpolation	Bilinear (Default)	Points are connected with lines to find approximations. This create smoother images. When [Bilinear] is selected, the processing time increases.
	None	Position compensation is performed at the pixel level.

• Measurement Data That Can Be Used for External Outputs and Calculations

You can use the values below as measurement data for external output and calculations.

Expression text string	Data name	Description	Data range
JG	Judgement	This is the judgement result.	-2: No judgement (not measured) 0: Judgement is OK -1: Judgement is NG

Setting Up Inspections

4-1 Inspection Item Selection Guide	134
4-2 Setup Procedure for Inspection Items	137
4-3 Configuring Inspection Items.	138
4-4 Reading with OCR	140
4-5 Reading Barcodes	179
4-6 Reading 2D-codes	190
4-7 Reading 2D Codes (DPM)	201
4-8 Inspecting with the Search Inspection Item	215
4-9 Inspecting with the Shape Search III Inspection Item	230
4-10 Inspecting with the Shape Search II Inspection Item.	247
4-11 Inspecting with the Sensitive Search Inspection Item.	259
4-12 Inspecting with the Edge Position Inspection Item	271
4-13 Inspecting with the Edge Width Inspection Item	282
4-14 Inspecting with the Edge Pitch Inspection Item.	288
4-15 Inspecting with Color Data Inspection Item	293
4-16 Inspecting with the Area Inspection Item	300
4-17 Inspecting with the Labeling Inspection Item.	310
4-18 Calculations and Judgments Using Inspection Item Data	323

4-1 Inspection Item Selection Guide

FQ2-S1









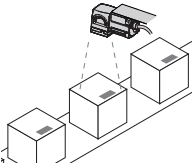

FQ2-S2

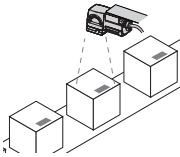

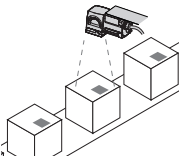

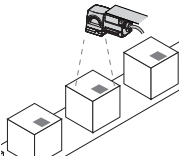

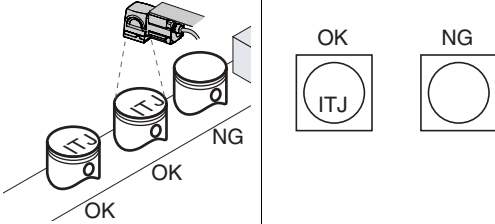



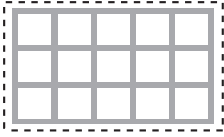
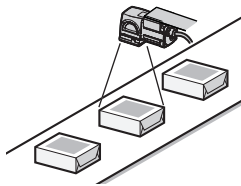
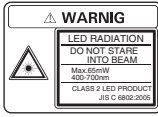
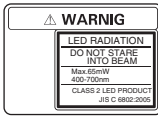

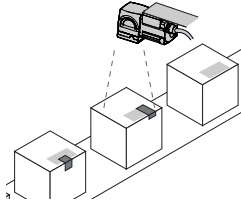

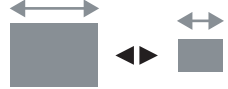
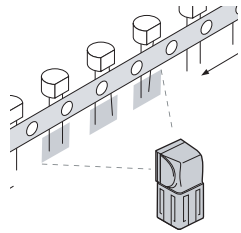

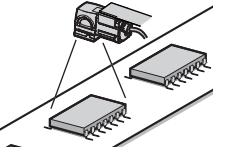

FQ2-S3

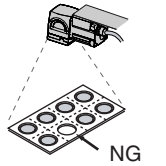

FQ2-S4

FQ2-CH

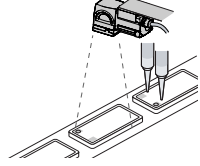
The FQ2 Sensor uses inspection items to judge measurement objects. There are thirteen different measurement objects. Select the best inspection items for the characteristics of the measurement object that are being judged.

Inspection	Example	Inspection items used	Compatible models	
Judging according to character recognition 	Checking printed consume-by-dates 	OK 2012.10.01 NG 2012.11.01	FQ2-S4 FQ2-CH	p. 140
Judging according to bar code 	Checking product information 	OK 12345 NG 12346	FQ2-S4	p. 179
Judging according to 2D-code 	Checking product information 	OK 12345 NG 12346	FQ2-S4	p. 190
Judging according to DPM 2D-code 	Reading 3D codes for direct part marking 	OK 12345 NG 12346	FQ2-S4	p. 201
Judging according to shapes 	Judging if there is a mark 	Search or Shape Search III	FQ2-S1 FQ2-S2 FQ2-S3 FQ2-S4	p. 215 p. 230
Detecting positions with patterns 	Measurement objects of the same color and pattern can be detected.	Search	FQ2-S1 FQ2-S2 FQ2-S3 FQ2-S4	p. 215

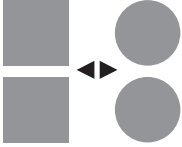
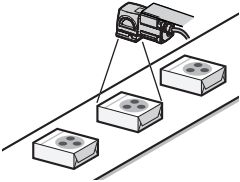
Inspection	Example	Inspection items used	Compatible models	p.
<p>Dividing the measurement area and judging according to shapes for each division</p> 	<p>Judging minute differences in printed labels</p> 	<p>OK</p>  <p>NG</p> 	<p>Sensitive Search</p> <ul style="list-style-type: none"> FQ2-S1 FQ2-S2 FQ2-S3 FQ2-S4 	<p>p. 259</p>
<p>Judging according to positions</p> 	<p>Measuring the position offset of a seal</p> 	<p>OK</p>  <p>NG</p> 	<p>Edge Position</p> <ul style="list-style-type: none"> FQ2-S1 FQ2-S2 FQ2-S3 FQ2-S4 	<p>p. 271</p>
<p>Judging according to widths</p> 	<p>Measuring the width between lead wires</p> 	<p>OK</p>  <p>NG</p> 	<p>Edge Width</p> <ul style="list-style-type: none"> FQ2-S1 FQ2-S2 FQ2-S3 FQ2-S4 	<p>p. 282</p>
<p>Judging according to the features of parts of a shape</p> 	<p>Judging the number of pins</p> 	<p>OK</p>  <p>NG</p> 	<p>Edge Pitch</p> <ul style="list-style-type: none"> FQ2-S1 FQ2-S2 FQ2-S3 FQ2-S4 	<p>p. 288</p>
<p>Judging according to colors</p> 	<p>Detecting parts</p> 	<p>OK</p>  <p>NG</p> 	<p>Color Data</p> <ul style="list-style-type: none"> FQ2-S1 FQ2-S2 FQ2-S3 FQ2-S4 	<p>p. 293</p>
<p>Judging according to sizes</p> 	<p>Judging if there is silver paste</p> 	<p>OK</p>  <p>NG</p> 	<p>Area</p> <ul style="list-style-type: none"> FQ2-S1 FQ2-S2 FQ2-S3 FQ2-S4 	<p>p. 300</p>

Inspection	Example		Inspection items used	Compatible models	
<p>Judging according to shapes and quantities</p> 	<p>Judging the number of labels</p> 	<p>OK</p>  <p>NG</p> 	Labeling	<ul style="list-style-type: none"> FQ2-S1 FQ2-S2 FQ2-S3 FQ2-S4 	p. 310

4-2 Setup Procedure for Inspection Items

FQ2-S1

FQ2-S2

FQ2-S3

FQ2-S4

FQ2-CH

The basic steps for setting up inspection items are shown below.

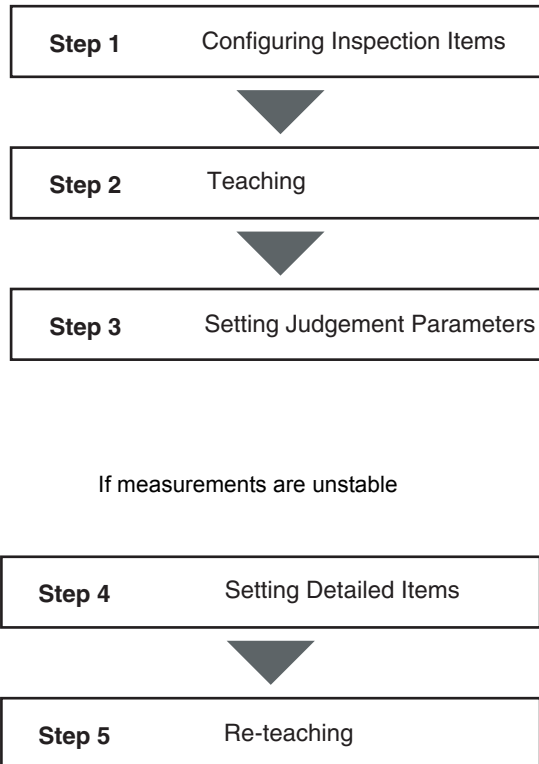

Note

Only one inspection item can be used on the FQ2-S1 Series.
A combination of up to 32 inspection items can be used on the FQ2-S2/S3/S4/CH Series.

4-3 Configuring Inspection Items

FQ2-S1

FQ2-S2

FQ2-S3

FQ2-S4

FQ2-CH

Adding New Inspection Items

1 Press [Inspect] – [Inspection].

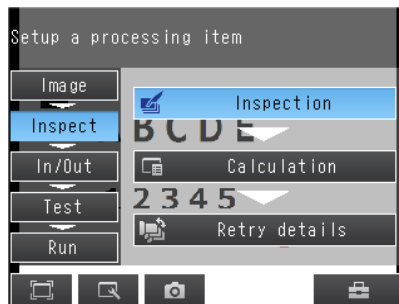

2 Press an unused inspection item number.

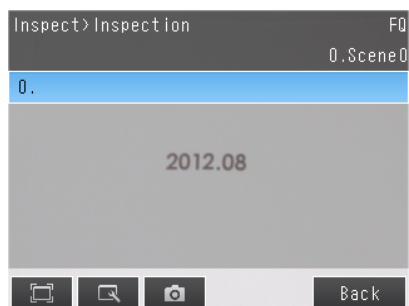

3 Press [Add item.] on the menu.

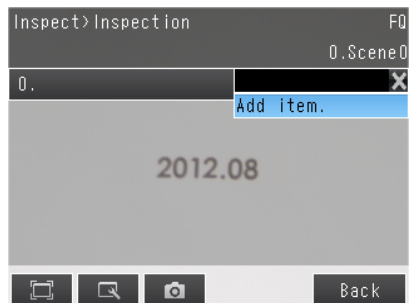

4 Select an inspection item, such as [Search].

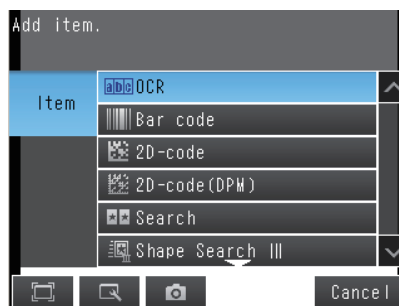

When registering multiple inspection items, press the inspection item number after 1.-- and set it in the same way.

Note

If more than seven inspection items are set, drag the  icon at the bottom of the menu upward to display the next inspection item numbers.

Modifying Existing Inspection Items

- 1 Press the number of the inspection item to be set.

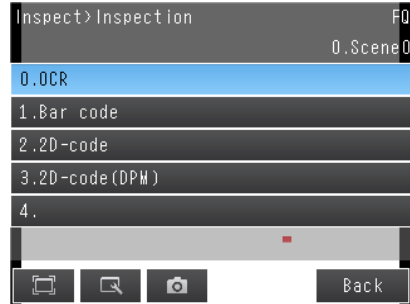

- 2 Press [Modify] on the menu.

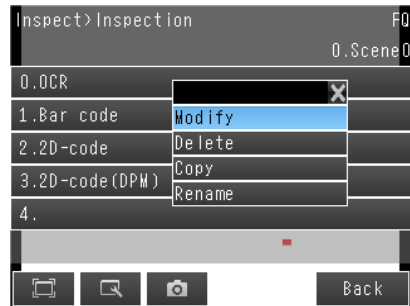

Deleting Inspection Items

- 1 Press the number of the inspection item to be deleted.
- 2 Press [Delete] on the menu.

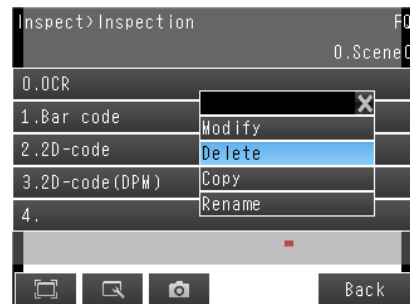

Note

Executing Similar Measurements in Different Places.

- Copy an inspection item that is already registered: [Copy].
- Change the name of an inspection item: [Rename].

4-4 Reading with OCR

FQ2-S4

FQ2-CH

Character String Recognition

Character recognition is used to read characters in input images as character information based on font information that is registered in the Sensor in advance. The characters that were read can be output to an external device.

You can also verify the character string that was read to see if it matches a character string that was registered in advance or the read result from a Bar Code^{*1}, 2D-code^{*1}, 2D-code (DPM)^{*1}, or OCR inspection item that was registered before the inspection item number currently being set.

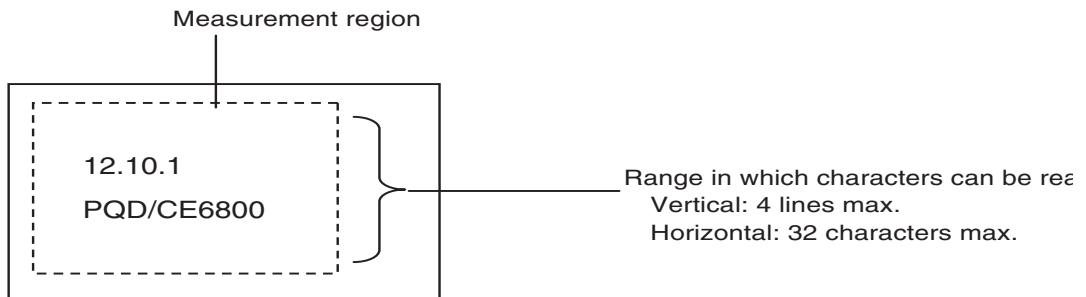

*1 FQ2-S4 series only

*2 Up to 16 characters per line can be displayed in the result display.

Characters That Can Be Recognized

Item	Description
Numbers ^{*1}	0 to 9
Letters ^{*1}	A to Z ^{*1}
Symbols ^{*1}	' (apostrophe) - (hyphen) . (period) : (colon) / (slash) () (parentheses)

*1 Any symbols other than those that are listed above cannot be recognized.

Note

You can also register a custom font for character recognition.
Set the custom dictionary before setting character recognition.

 *Registering a Custom Dictionary*: p. 170

Setup Procedure for Character Recognition

The setup for character recognition is performed in the following order.

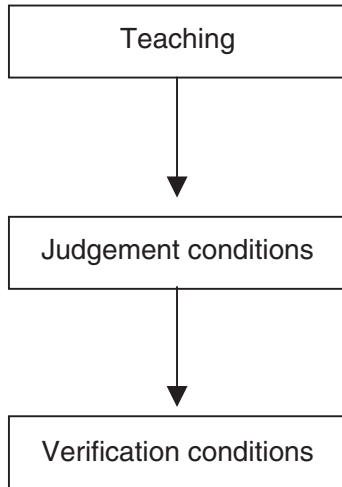

The basic settings to recognize characters are made.

- Character format (number of characters, alphanumeric characters or symbols, etc.)
- Measurement region
- Detailed parameters to recognize characters (These are set automatically.)

Settings are made to check whether the characters that were read from the workpiece were recognized correctly. Differences between the references that were taught for character recognition and the actual result of reading the characters are detected and conditions are set to determine how accurately characters are read.

You can set conditions to verify that the character string that was read matches a specific character string. The character strings to use to verify the character strings that are read are registered in the master data.

Setup Procedure for Character Recognition

Step 1 Selecting the Inspection Item

► [Inspect] – [Inspection]

- 1 Press an unused inspection item number and press [Add item.].

- 2 Press [OCR].

Inspection Item Selection Guide: p. 138

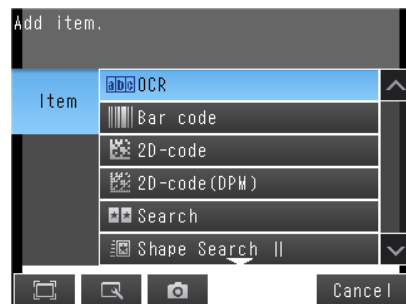

Note

Drag the arrow () at the bottom of the menu to display all of the inspection items.

Step 2 Teaching

In this Teaching function, specifying Measurement region, Character color, Printing type and Correct string, the measurement parameters for OCR are set automatically.

1 Touch [TEACH].

2 Capture the characters for recolonization.

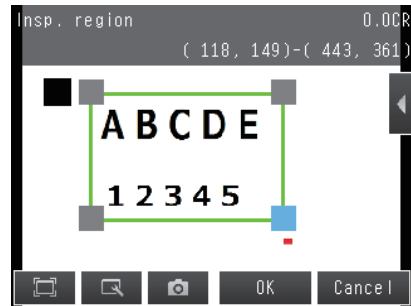

3 Move the rectangle around the character string to read, and then press [OK].

The measurement region will be set.

4 Select [Character Color],

When the [Cancel] is touched, the all settings will be discarded, and then window will return to the previous setting.

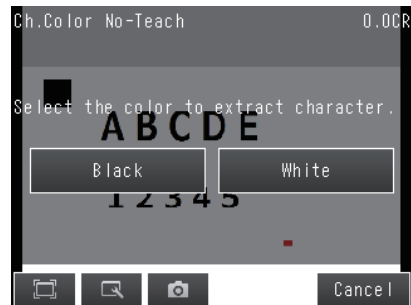

Item	Setting item	Description
Character color	<ul style="list-style-type: none"> Black White 	Select this item when the background is Black and character color is White. Select this item when the background is White and character color is Black.

5 Select [Printing type].

When the [Cancel] is touched, the all settings will be discarded, and then window will return to the previous setting.

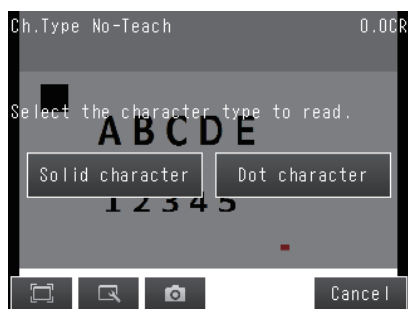

Item	Setting Item	Description
Printing type	<ul style="list-style-type: none"> • Solid character • Dot character 	Select Printing type for the character to inspect.

6 Select [Teach Mode].

[Correct String] is recommended normally.

When you select [Simple Teach], go to Step 8.

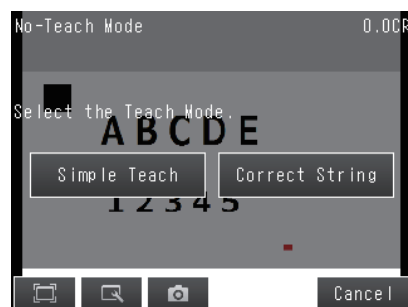

Item	Setting Item	Description
Teach Mode	<ul style="list-style-type: none"> • Simple Teach • Correct String 	<ul style="list-style-type: none"> • Simple Teach Specify the Region setting, Character color, and Printing type to execute OCR, and then the measurement parameters are defined. Then measurement parameters are adjusted automatically until the specified characters matches with read result. Simple Teach is useful when the correct strings can be recognized even though the correct strings are not specified. • Correct String Specify the Region setting, Character color, and Printing type to execute OCR, and then the measurement parameters are defined.

7 Enter your attempted correct string, and then touch [OK].

Acceptable strings: 0 to 9

- A to Z
- ' (apostrophe)
- (hyphen)
- . (period)
- : (colon)
- / (slash)
- () (parentheses)

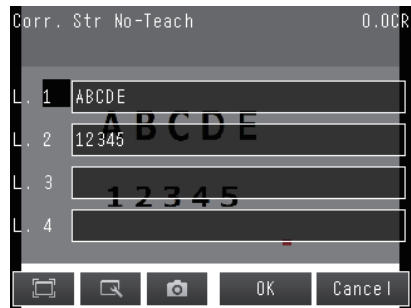

8 Press [TEACH] on the lower-right window.

The Measurement parameters for OCR will be set automatically.

 *Measurement Parameters That Are Automatically Set by Teaching: p. 156*

9 Character string that is successfully to recognize is displayed. Confirm the result, and then touch [OK].

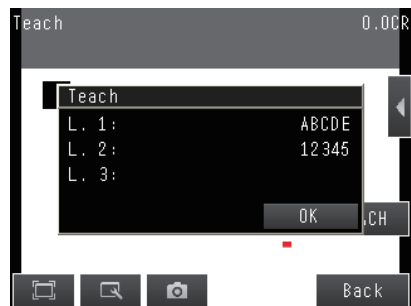

10 Press [Back] to end teaching.

The measurement parameters are adjusted automatically after Teaching. Character format is set automatically from the result.

- For confirming character format.



Select [Format] from the  menu button.

The following table gives detailed specifications for the character format.

Item	Description
Characters that can be entered in the character format string	<p>Numbers: 0 to 9 Letters: A to Z Symbols: ' (apostrophe), - (hyphen), . (period), : (colon), / (slash), () (parentheses)</p> <p>Wildcards You can use wildcards to specify characters. For example, you can use wildcards to prevent incorrect recognition of 0 (zero) and O (the letter O).</p> <p>?: Any character (recognized characters: any characters except for symbols) #: Any number from 0 to 9 (recognized characters: 0 to 9) \$: Any letter from A to Z (recognized characters: A to Z) @: Skip (No judgment is made for the judgment conditions (similarity or stability). *: any single character (Alphabetic character, Numeral, and Symbols are recognizable.) &: Any symbol (recognized characters:' (apostrophe),- (hyphen),. (period),: (colon), / (slash), () (parentheses))</p> <p>The detected character count is also not incremented.)</p>
Limits to the character format string	<p>Each line can have a maximum of 32 characters. There can be a maximum of four lines. Characters must be input from line 1. (You cannot skip line 1 and set the character format string starting with line 2.) If you leave any line blank, the setting for the next line will be moved up to fill it.</p> <p>You cannot specify a symbol by itself. You cannot specify more than symbol consecutively. You cannot specify more than 16 symbols on one line.</p>

Note

You can use  on the right of the display to access the following menu commands to change the following settings

- [Teach mode]: You can change the Teach mode.
- [Insp. region]: You can change the measurement region for OCR.
- [Format]: You can change the setting of the character format.
- [Correct String]: You can change the correct string.
- [Camera setup]: You can adjust the Camera focus, brightness, and other factors to input a better image.
 . *Inputting Better Images: p. 76*
- [Meas. Parameter]: You can change the type of code to read, the read settings, etc..
 . *Detailed Parameters: p. 156*
- [Continuous test]: You can start test measurements of displayed images for the settings that were taught.
 . *Test Measurements: p. 340*

Step 3 Setting the Judgment Parameters

Settings are made to check whether the characters that were read from the workpiece were recognized correctly. Differences between the references that were taught for character recognition and the actual result of reading the characters are detected and conditions are set to determine how accurately characters are read.

► [Inspect] – [Inspection] – [OCR] – [Settings] Tab Page

1 Press [Judgement].

2 Press each parameter and set the range that is to be judged as OK.

Set the range for each of the following parameters. Continuous measurements will be performed for the images that are displayed.

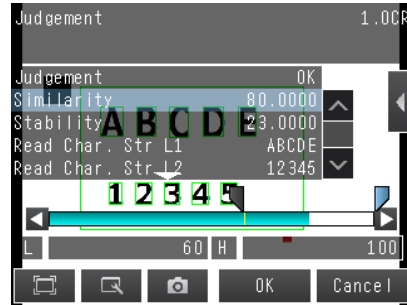



Note

- You can change measurement values that appear on the display on the Display Settings Display.

Press  – [Display setting] on the right of the display to switch to the Display Settings Display.

- You can automatically adjust the judgment conditions by using OK and NG workpieces.

 *Test Measurements: p. 346*

Press  – [Auto adjustment] on the right of the display to switch to the Auto adjustment Display.

- You can set the judgment condition depending on figure numeral, alphabet, or character type.

Touch  – [Judgement mode], displays the Judgement mode window.

- Whole setting: Set the same judgment condition to all of the character strings.
- Individual setting: Set judgment condition to each character strings.

3 Press [OK] to enter the values.

Item	Parameter	Setting	Description
Judgement	Similarity	0 to 1000 Default Upper limit: 100 Lower limit: 60	Sets the similarity of the read characters that is to be judged as OK. If any of the characters in the read character string has a similarity that is lower than the set value, the judgment will be NG. To judge incomplete or worn characters as NG, set a high upper limit for the similarity.
	Stability	0 to 100 Default Upper limit: 100 Lower limit: 10	Sets the stability of the read characters that is to be judged as OK. If there is more than one candidate for the same character, the difference between the first and second candidates is numerically expressed by the stability. (For example, if the similarity of the first candidate is 90 and the similarity of the second candidate is 25, then the stability is $90 - 25 = 65$.) To prevent misreading similar characters, set a high value for the stability.
	Read Ch.Str L1 to Read Ch.Str L4	—	Displays the detected character strings.
	Verif. Str L1 to Verif. Str L4	—	Displays verification character strings. The verification strings are displayed only the verification pattern is set.
	Num. of char.L1 to Num. of char.L4	1 to 32 Default Upper limit: 32 Lower limit: 0	Set the number of characters to judge as OK.

Note

You can specify whether to reflect the judgment result of the judgment conditions for character recognition in the overall judgment. (The Default is to reflect them.)

► **[Inspect] – [Inspection] – [Add item.] – [OCR] – [Details] Tab Page – [Output parameter] – [Reflect]**

Step 4 Setting the Verification Conditions

Register the character string based on read character match to specific character string. Matching Mode, select Direct input, Calendar Matching, or Code Matching.

Parameter	Setting	Description
Matching Mode	Direct Input	Direct Input the verification strings as a Master data, A maximum of 32 types of registered Master data can be simultaneously verified. The result is reflected to the external reference parameters. This result can be output to the external device using communication command. fixed character string length is 32 characters X 4 lines.
	Calendar Matching	Verify with the sensor calendar information. For the verification, the character length including calendar is 32 characters. The number of the verification master data is one.
	Code Matching	Verify with the following functions. <ul style="list-style-type: none"> • 2D code • 2D code (DPM) • Code Reader (description as CR) For verification target is the loaded result of CR inspection item. The number of the verification master data is one.

Important

When you select Calendar Matching, the date and time information must be loaded, or updated via TouchFinder, or external device connection, such as with PLC. Without date and time settings for Calendar Matching, the verification string will be zero.

 *4 Set or Acquire the Date and Time: p. 167*

Specify the Verification String with Direct Input

► [Inspect] – [Inspection] – [Add item.] – [OCR] – [Settings] Tab Page

1 Touch [Verification].

2 Touch [Matching Mode],
and then select [Direct Input].

3 Touch [Master data regist.].

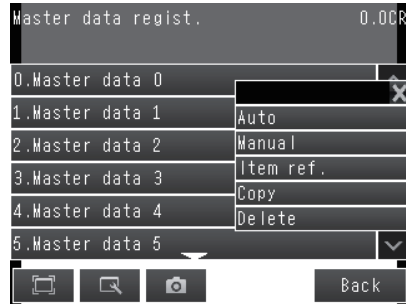

4 Touch the master data to register.

5 You can use any of the following three methods to register character strings in the master data from the menu display.

[Auto]: A character string is read from an image and registered in the master data.
The procedure is essentially the same as the procedure for teaching in step 2.

[Manual]: A character string is entered directly in the master data.
Select this menu when making a change to the master data registered using [Auto] menu.
You can use a software keyboard to register a character string with up to 32 characters.

Note

You can set letters, numbers, symbols, and the following wildcards: * and ?.

- *: A wildcard for a character string of 0 or more characters
- ?: A wildcard for one character (alphabetic or numeric)

[Item ref.]: Select this item to use the immediately preceding read results as the verification character string.

The following inspection items can be used as references.

- FQ2-S4 Series: Bar code, 2D-code, 2D-code (DPM), and OCR
- FQ2-CH Series: OCR

You cannot reference an inspection item that is after the current inspection item. After a character string is registered, a reference item number, such as "Ref. 00," will be displayed to the right of the character string in the master data.

Note

On FQ2-S4 Series, you can set the [Item ref.] verification condition to check if characters that are printed near a barcode or 2D code match the contents of the barcode or 2D code.

Place the inspection item to read the barcode or 2D code to check before the OCR inspection item and then specify the [Item ref.] verification condition for the OCR inspection item. The verification condition will be used to verify whether the character string from the barcode or 2D code and the characters printed below it match.

You can output the verification result.

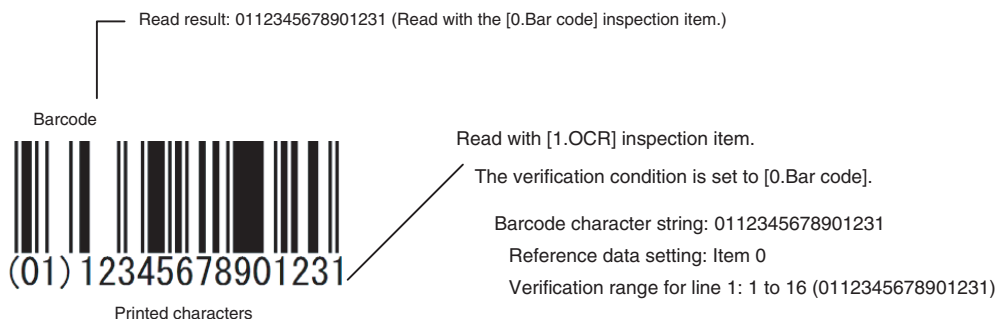

6 Repeat the above procedure to register more than one character string in the master data.

7 Touch [Verif. master data] and select the character string in the master data to use for verification.

Note

You can automatically register the read result from teaching from an external device in the character string with number that is specified [External teach No.] in the master data.

8 Touch [Back].

Parameter	Setting	Description
Matching mode	<ul style="list-style-type: none"> • Direct Input (Default) • Calender Matching • Code Matching 	Select your attempted Matching mode.
Verif. master data	<ul style="list-style-type: none"> • OFF (Default) • All master data Master data 0 to 31 	Sets whether to verify the read character string against a character string that is registered in the master data. To verify the read character string against the master data, select the character string to use for verification.
Master data regist.	---	Registers a character string in the master data. Use [Manual] menu when making a change to the [Partial Verification] setting for master data originally registered by [Auto].
External teach No.. (Only the Direct Input is selected.)	<ul style="list-style-type: none"> • OFF (Default) Master data 0 to 31 	Sets the character string in which to automatically register the read result for teaching from an external device.

Specify the Verification String with Build-in Calendar

1 Touch [Verification].

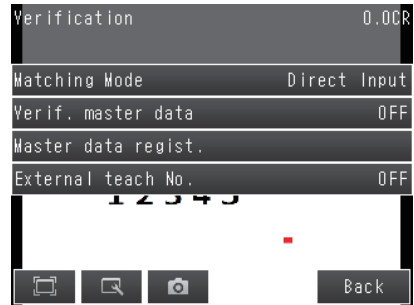

2 Touch [Matching Mode].

3 Touch [Calendar Matching].

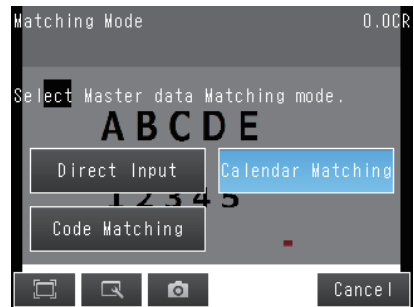

4 Touch [Master data regist.].

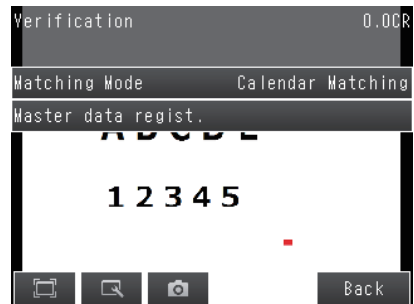

5 Touch lines, a soft keyboard appears. Enter your attempt date to each lines.

Enter formats of the alphabetical characters or date to be read.

Examples of Acceptable Formats

- To recognize the text string "2014/01/01," enter "2014/01/01" in the string format area.

- To recognize four-digit numbers, enter as [####], where each "#" represents a number, in the string format area.

- To recognize 3 digits - the current year / the current month

Enter "****-mYYYY#/mMM#".

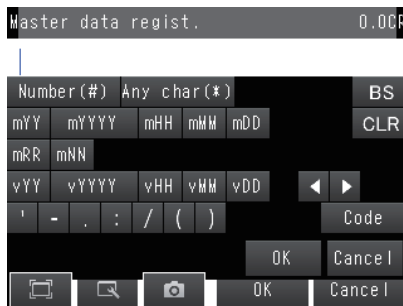
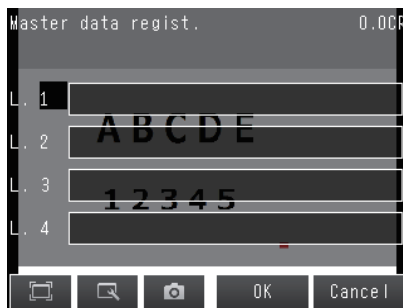

Label	Description	Label	Description
0 to 9	Normal numeric value input	eY1	Coded year 1
A to Z	Normal alphabetic character input	eM1	Coded month 1
' - . : / ()	Normal symbol input	eD1	Coded day 1
*	Uppercase alphabetic character judgment, Numeric character judgment and Symbol judgment	eR1	Coded hour 1
#	Numeric character judgment	eN1	Coded minute 2
mYY	Current year, 2 digits	eY2	Coded year 2
MYYYY	Current year, 4 digits	eM2	Coded month 2
mHH	Current year of the Heisei imperial era, 2 digits	eD2	Coded day 2
mMM	Current month	eR2	Coded hour 2
mDD	Current day	eN2	Coded minute 2
mRR	Current hour	iY1	Coded year after set interval 1
mNN	Current minute	iM1	Coded month after set interval 1
vYY	Year after set interval, 2 digits	iD1	Coded day after set interval 1
vYYYY	Year after set interval, 4 digits	iY2	Coded year after set interval 2
mHH	Year of the Heisei imperial era after set interval, 2 digits	iM2	Coded month after set interval 2
vMM	Month after set interval	iD2	Coded day after set interval 2
vDD	Day after set interval		

6 Touch [OK].

7 Touch [Back].

Specify the Verification String in Code Matching Function

► [Inspect] – [Inspection] – [Add item.] – [OCR] – [Settings] Tab Page

1 Touch [Verification].

2 Touch [Matching Mode].

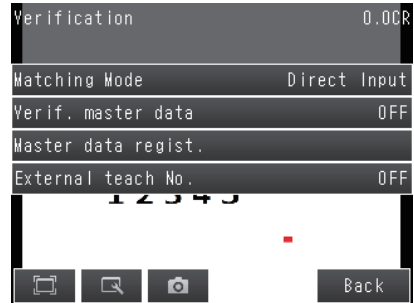

3 Touch [Code Matching].

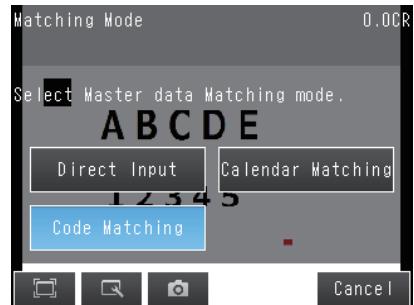

4 Touch [Master data regist.].

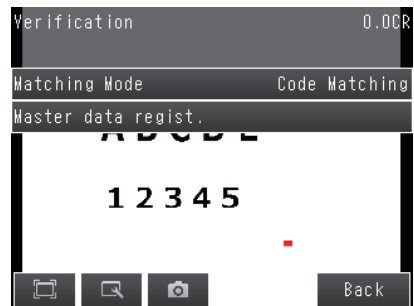

- 5** Touch [Item ref.], and then select the Code Matchin items to refer.



- 6** Touch Line number for verification.

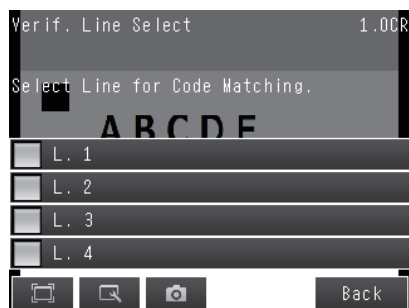

- 7** Set the Verification region as necessary.



- 8** Touch [Back].

Parameter	Setting	Description
Matching mode	<ul style="list-style-type: none"> • Direct Input (Default) • Calendar Matching • Code Matching 	Select your attempted Matching mode.
Item ref.	<p>The following registered function before setting of item ref.</p> <ul style="list-style-type: none"> • Bar code • 2D-code • 2D-code (DPM) (Default: None) 	Use this parameter when you set the latest result as a verification string. Specify the Processing item for the verification string.
Line for varif.range	<ul style="list-style-type: none"> • Check • Un-check (Default) 	Select the line 1-4 for which to apply Calendar Matching.
L1. verif. range	<p>1 to 1024 (Default Start Line: 1 Finish Line: 1024)</p>	Specify the result range of Calender Machining function that is compare with line 1.
L2. verif. range		Specify the result range of Calender Machining function that is compare with line 2.
L3. verif. range		Specify the result range of Calender Machining function that is compare with line 3.
L4. verif. range		Specify the result range of Calender Machining function that is compare with line 4.

Setting the Measurement Parameters

When you perform teaching, the measurement parameters are set automatically.

If you obtain incorrect reading results with the automatic settings, set the measurement parameters manually.

► **[Inspect] – [Inspection] – [OCR] – [Details] Tab Page – [Meas. parameter]**

Detailed Parameters

Parameter	Setting	Description
Reading Speed	<ul style="list-style-type: none"> Normal (Default) Fast 	Set the speed to read characters. When the space is large between characters, select [Fast].
Character color	<ul style="list-style-type: none"> Black (Default) White 	Sets the color of the characters to detect.
Printing type	<ul style="list-style-type: none"> Solid character (Default) Dot character 	Sets the type of printing of the characters to detect. When using a custom dictionary, set this to the same setting as [Meas. parameter] – [Printing type] of the dictionary.
Dot ver. interval	0 (Default) to 30	Adjusts the vertical dot interval of the characters to detect. This parameter is enabled only when [Printing type] is set to [Dot character].
Dot hor. interval	0 (Default) to 30	Adjusts the horizontal dot interval of the characters to detect. This parameter is enabled only when [Printing type] is set to [Dot character].
Char. thick. th.	-255 to 255 (Default: 0)	Sets the thickness of the characters. Negative numbers indicate thinner characters. Positive numbers indicate thicker characters. Recognition performance will improve for positive numbers, but noise will increase, causing instability.
Boundary correction	<ul style="list-style-type: none"> ON OFF (Default) 	If boundary correction is turned ON, dark areas at the edges of the measurement region will be considered to be noise and removed from the read candidates.
Rotation compensation	<ul style="list-style-type: none"> ON OFF (Default) 	If rotation compensation is turned ON, the image will be compensated for a -15° to 15° rotational variation. (This setting compensates for rotational variations in the placement of the workpiece on the line, and not for rotational variations in the characters themselves that result from printing conditions.)
Slant compensation	<ul style="list-style-type: none"> ON OFF (Default) 	If slant compensation is turned ON, the image will be compensated for a -20° to 20° slant variation. (This setting compensates for slant variations in the placement of the workpiece on the line or in the printing mechanism, and not for italic fonts.)
Hyphen height upp. th.	0 to 100 (Default: 30)	Sets the upper limit of the height of the region to treat as a hyphen or other symbol.
Hyphen height low. th.	0 to 100 (Default: 70)	Sets the lower limit of the height of the region to treat as a hyphen or other symbol.
Slender char. th.	1 to 10 (Default: 3)	Sets the ratio of the height to the width of the detection character rectangle to judge as thin characters (l, J, 1, ;, and /).
Max Width Setting	<ul style="list-style-type: none"> ON OFF (Default) 	Set the Max Width Setting to ON or OFF.
Max Width	0 to 9,999 (Default)	Specify the max width of the character to be read.
Max Height	0 to 9,999 (Default)	Specify the max height of the character to be read.
Min Height	0 to 100 (Default: 50)	Specify the min height of the character to be read.
Read Length	<ul style="list-style-type: none"> Variable (Default) Fixed 	If character strings with a variable number of characters are to be read, specify variable. The character format should be the same as the maximum character string length format.

Important

When loading Scene data from an older version, the [Legacy Mode] Setting appears above the measurement parameters.

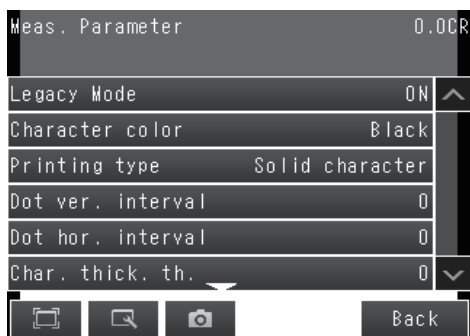

The [Legacy Mode] allows for Scene data, or Dictionary data created with software versions older than ver. 2.10 to be usable with ver. 2.02, or later software. The Dictionary data created with the old software version can only be used with Scene data also created from the old software version. If you touch [Legacy Mode], which is above the measurement parameters, the following dialog appears. Touching [Yes] will update the settings to version 2.10, or later.

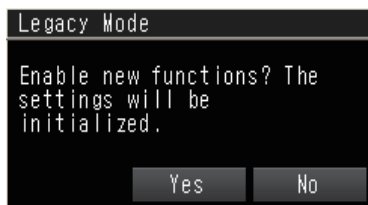

Use Dictionary data with Scene data created with the same Sensor version. In [Legacy Mode] use only Dictionary data created with Sensor version older than ver. 2.02. Likewise, with Sensor version 2.10 or later, use Dictionary data created in Sensor version 2.10, or later. The following dialog will appear if there is a version mismatch.

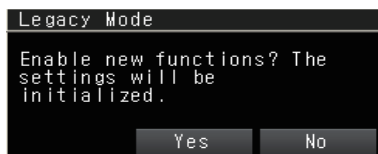

• **Executing Teach function, parameters are set automatically**

The following parameters in measurement parameters, are automatically set by executing Teach function.

Parameter	Setting	Parameter	Setting
Character color	Manual	Rotation compensation	Auto
Printing type	Manual	Slant compensation	Auto
Dot ver. interval	Auto	Max Width Setting	Auto
Dot ver. interval	Auto	Max Width	Auto
Char.thick.th.	Auto	Max Height	Auto
Boundary correction	Auto	Min Height	Auto

Limiting Readable Characters

Limiting the readable characters decreases the possibility of mis-reading similar characters.

- ▶ **[Inspect] – [Inspection] – [OCR] – [Details] Tab Page — [Dictionary parameter] — [Individual char.]**

Changing the Output Code for Errors (Default: NG)

You can change the character string that is output for read errors.

(The output code must be no more than 20 characters.)

- ▶ **[Inspect] – [Inspection] – [OCR] – [Details] Tab Page – [Output parameter] – [Error string]**

Troubleshooting Unstable Read Results

- The read results may be unstable if the contrast is low. Adjust the brightness to improve the contrast.
- Set a custom dictionary.
- Adjust the detailed parameters.

When reading a variable length string

Set the Read Length of measurement parameters to Variable.

Then set the character format to the maximum character string format.

Setting Date Parameter

Set the date, time or update setting.

► [Inspect] – [Inspection] – [Add item.] – [Details] tab – [Date parameter]

1 Touch [Period setting], and then set Year, Month and Day.

Item	Setting	Description
Year	Range : 0 to 99 Default : 0	Set the usage period from the current date.
Month	Range : 0 to 99 Default : 0	
Day	Range : -999 to 999 Default : 0	

2 Touch [Date setting], and then set the following settings.

Item	Setting	Description
Zero suppress	<ul style="list-style-type: none"> • [0] • Space 	Set how the tens digits of the month and day are displayed.
Calculation order	<ul style="list-style-type: none"> • Month→Day • Day→Month 	Set whether to calculate the month first or the day first when the usage period is set. (This affects calculation of end of month.)
Month end adjust	<ul style="list-style-type: none"> • [Last day of current month] • First day of next month • Gap day of next month 	Set the adjustment method that will be used if the result of the expiration date calculation is an invalid date.

Note

Use the following examples as reference for setting of the date parameter.

E.g.1

Measurement is performed on 9/30, and the period setting is: Year: 1, Month: 1, Day: 1.

- [Month→Day]: A month is added to 9/30, and the result will be 10/30.
A day is added to 10/30, and the result will be 10/31.
- [Day→Month]: A day is added to 9/30, and the result will be 10/1.
A month is added to 10/1, and the result will be 11/1.

E.g.2

Measurement is performed on 1/31, and the period setting is: Year: 0, Month: 1, Day: 1.

- [Month→Day]: A month is added to 1/31, and the result will be 2/31.
The month end adjustment will be applied since 2/31 does not exist.
The result of the month end adjustment plus 1 will be the verification string.

Month end adjust	Result
Last day of current month	2/28
First day of next month	3/1
Gap day of next month	3/3

- [Day→Month]: A day is added to 1/31, and the result will be 2/1.
The month end adjustment will not be applied since 2/31 exists.
A month is added to 2/1, and the result will be 3/1.
- [Day→Month]: A day is added to 1/31, and the result will be 2/1.
The month end adjustment will not be applied since 2/31 exists.
A month is added to 2/1, and the result will be 3/1.

Measurement is performed on 10/30, and the period setting is: Year: 0, Month: 1, Day: 1.

- [Month→Day]: A month is added to 10/30, and the result will be 11/30.
The month end adjustment will not be applied since 11/30 exists.
A day is added to 11/30, and the result will be 12/1.
- [Day→Month]: A day is added to 10/30, and the result will be 10/31.
A month is added to 10/31, and the result will be 11/31.
The month end adjustment will be applied since 11/31 does not exist.

Month end adjust	Result
Last day of current month	11/30
First day of next month	12/1
Gap day of next month	12/1

3 Touch [Common Setting], and then set Auto Update, Back margin and Ahead margin.

Item	Setting	Description
Auto Update	<ul style="list-style-type: none"> • Not update • First Update • Always update (Default) 	<p>Select the condition for updating the date. The time is always updated.</p> <ul style="list-style-type: none"> • Not update The date is not automatically updated. Update the date using the menu. • First Update Updates the Sensor day and time information at the first launch. • Always update The date is updated when measurement is performed. When the controller is kept running more than one day, the date is updated the first time measurement is performed after the date changes.
Ahead margin	<p>Range: 0 to 99 Default: 0</p>	<p>Set an appropriate count back time from the current time. Set in units of minutes. Set this when the printing time is different from the inspection time.</p>
Back margin	<p>Range: 0 to 99 Default: 0</p>	<p>Set an appropriate count forward time from the current time. Set in units of minutes. Set this when the printing time is different from the inspection time.</p>

Touching [Date update], date and time of Verify String will be updated.

4 Touch [Back].

Code data Parameters

Set the Code data format to measure the encrypted date and time information.
For changing of Code data parameters, refer to the following two method.

- Code data edit tool
- Set using PC

Important

When you use the period setting, the encrypted data is unacceptable for OCR.

Code data edit tool

Set the Code data using Code data edit tool

Download the Code data edit tool from the OMRON website.

For registration of OMRON website, confirm the SYSMAC ID ***** that comes with Sensor.

The following explanation of settings is for the example of an October date encrypted as X.

Describes the setting method.

- 1 Launch the Code data edit tool.**
- 2 In the code detail setting area, select the "Code month 1 flag" check box.**

Note

Code month 1 and code month 2

- Set up code files for 2 patterns in order to be ready for set changes. Select a check at the one to use.

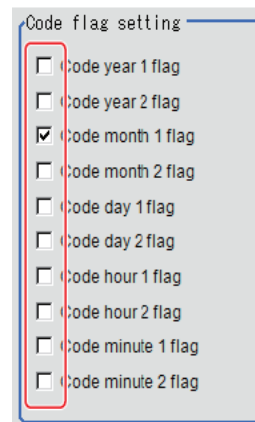

- 3 Place a check at "Code month 1" in the "Code detail setting" area.**

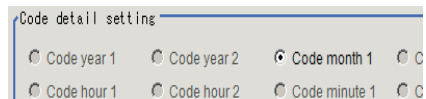

- 4 Enter "X" in the [10:].
For character string, enter with in four strings.**

- 5 Select the code file (CSV format) to be loaded in the file selection screen, and click [OK].The code file is loaded and displayed on the screen.
- 6 Click [Save].

Set Code Data using PC

Since the Code data file is complicated, it is best to edit it using a PC. Once an empty CSV file is saved , edited on a PC and then re-loaded, it can most efficiently be used.

- **Save the Code Data**

Create an empty file for editing with PC.

If the Code data has already been set in Sensor, a file having the settings will be saved.

▶ [Setup] – [Save to file] – [Setting] tub

1 Touch [Code data].

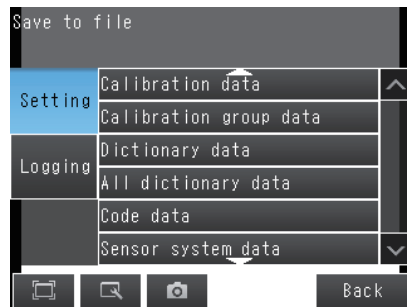

2 Touch the code data number you wish to save.

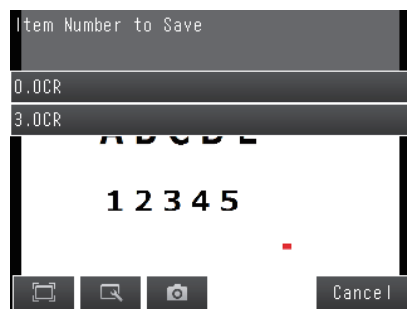

- 3 Enter file name, and then touch [OK].
(Default file name; code.csv)



- **Code File Format**

- “Item” appears on the 1st line.
- “Flag” appears on the 2nd line. To use the item, set “1”.
- On the 3rd and following lines, the code corresponding to each number appears.
The month and day start from “1”.

Code	Year 1	Year 2	Month 1	Month 2	Day 1	Day 2	Hour 1	Hour 2	Minute 1	Minute 2
Flag	0	0	0	0	0	0	0	0	0	0
0										
1										
2										
3										
4										
:										
:										
95										
96										
97										
98										
99										

Loading a Code File

▶ [Setup] – [Load from file]

1 Touch [Code data].

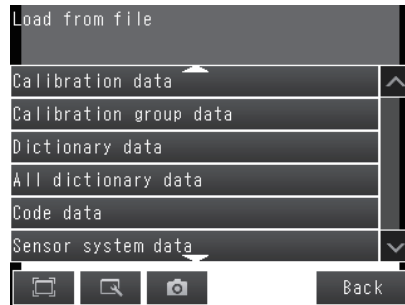

2 Touch Code data number to load.

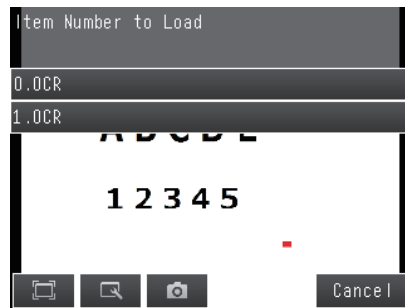

3 Select the Code data.

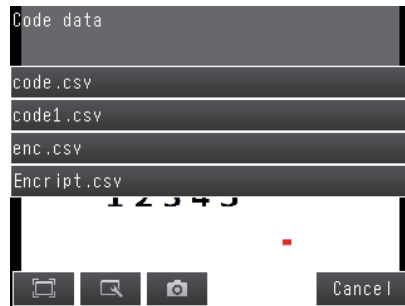

4 Touch [Yes].

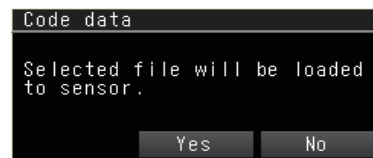

Confirm the Code Data Name

The current Code data name can be confirmed with the following steps.

► [Inspect] – [Inspection] – [Add item] – [OCR] – [Detail] tab

1 Touch [Code data].

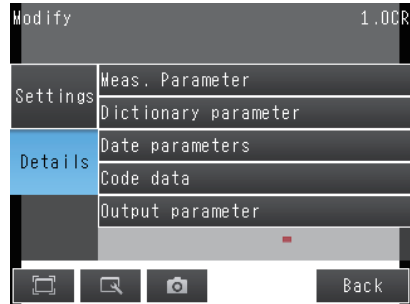

2 The Code data file name is displayed.



Set or Acquire the Date and Time

Since the Sensor does not have date and time information, setting or acquirement of date and time is necessary for Calendar Matching function.

Set or acquire the Date and Time by any the following methods.

- Set the Date and Time information automatically when TouchFinder is connected to the Sensor.

► [Setup] - [Sensor settings] - [Current Day/Time]

1 Touch [Auto-Sync with TF]

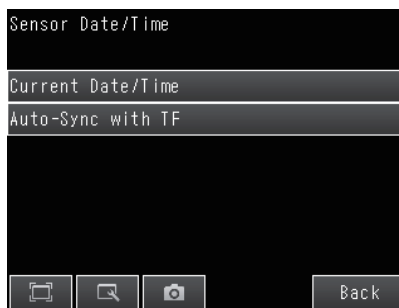

2 Touch [ON].

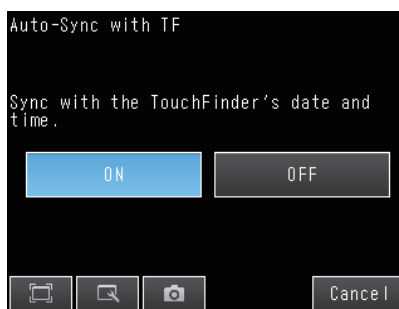

Important

- When you re-connect the TouchFinder to Sensor, the day and time information is acquired,
- If one more than Sensors are connected to the TouchFinder, the day and time information of second connected TouchFinder is enabled.

- **Set or Acquire the Date and Time using the external device.**

Acquires the Date and Time information by sending a command from the external device.

For details, refer to *5-1 Command Control, Command List, and Command to Write Data in FQ2-S/CH User's Manual for Communications Settings.*

Confirm the Date and Time information

Date and Time information of Sensor is displayed.

Sensor Date and Time information will be initialized when the Sensor restarts.

▶  [Setup] – [Sensor settings] – [Current Day/Time]

1 Touch [Current Date/Time].

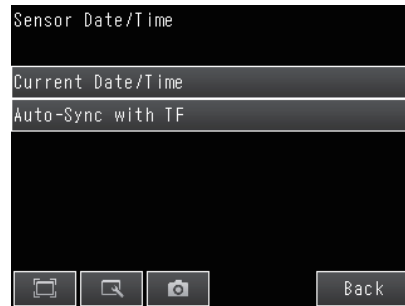

2 Date and Time information is displayed.

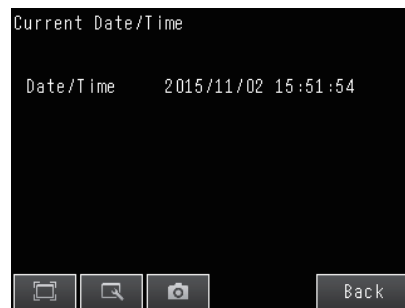

Perform OCR with creating dictionary (Model dictionary)

Characters in special fonts cannot be read correctly with the built-in dictionary. In this case, a custom dictionary can be created to read such characters. The size of characters that can be registered is 30 pix X 30 pix.

Creating Model Dictionaries to Recognize Custom Characters

Use the dictionary customize after adding [OCR] to Inspection item and finishing TEACH.
Configure model dictionary settings in the order below.

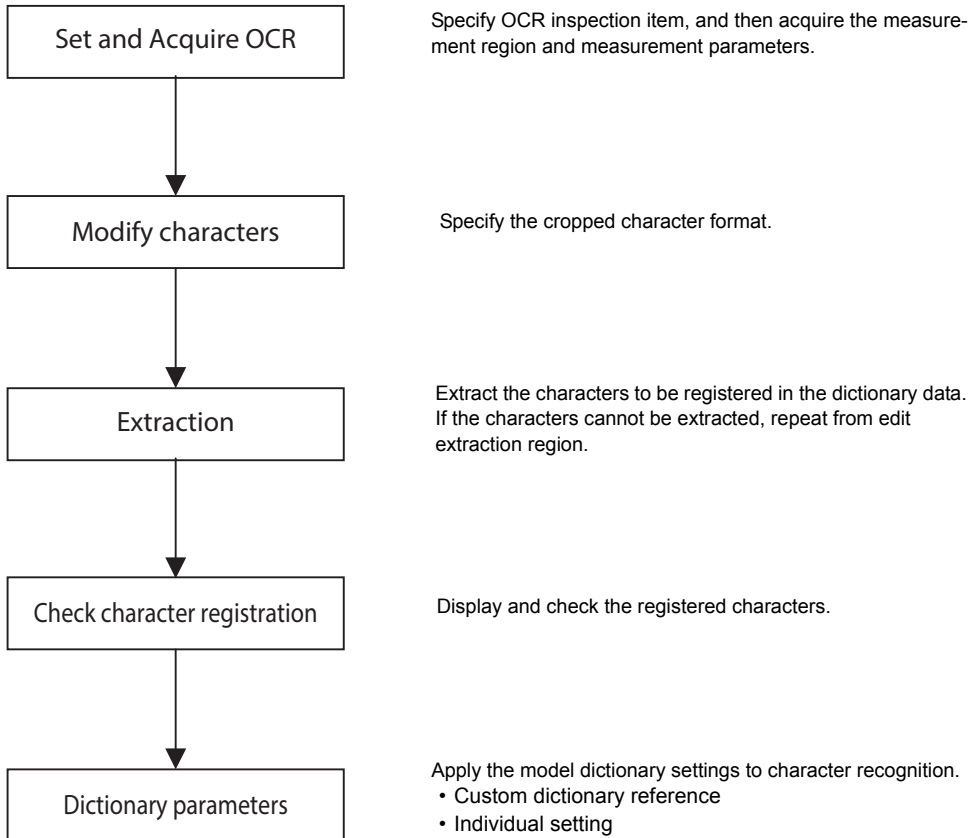

Setup Procedure for Model Dictionary

Creating a Dictionary

- 1 Press the Tool Button, and then [Model dictionary].

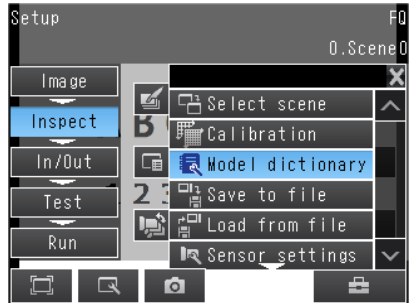

- 2 Press the dictionary in which to register characters.

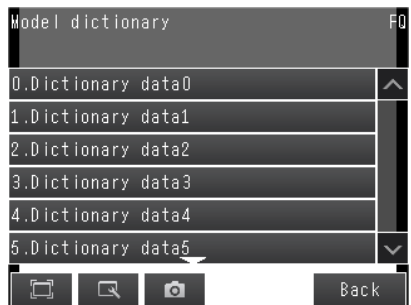

- 3 Press [Modify] on the menu.

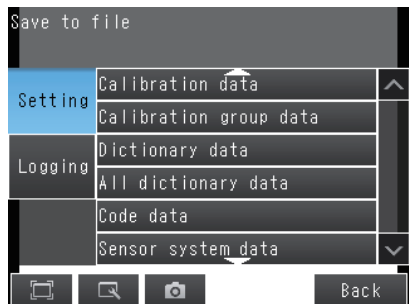

- 4 Press [Add].

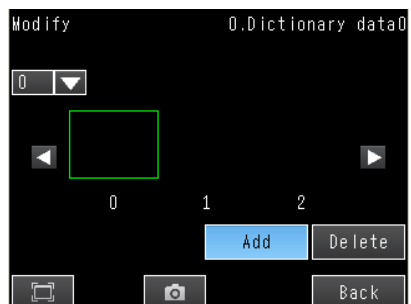

- 5 Touchpress  – [Load OCR setting].

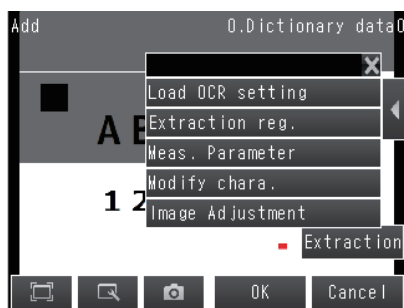

- 6 Touch inspect item to acquire the measurement range or measurement parameters.

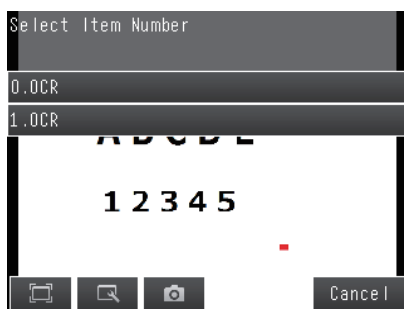

- 7 To change Extraction range, press  – [Extraction reg.] on the right of the display.

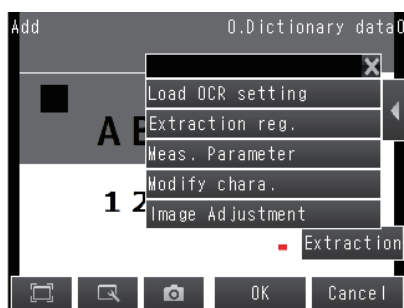

- 8 Specify the region to extract and press [OK].

The measurement region can contain character strings on up to four lines.
Each line can contain up to 32 characters.

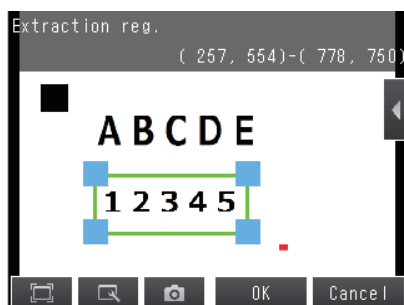

- 9 To extract characters based on a specified character format, press **[Modify chara.]** on the right of the display.

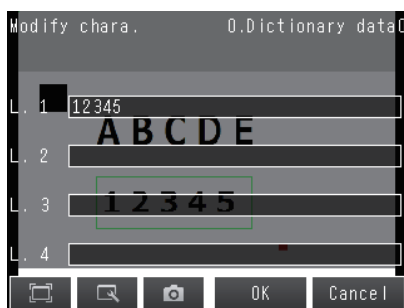

- 10 To edit the measurement parameters, press **[Meas. Parameter]** at the right of the screen.



Setting the Measurement Parameters: p. 156

Important

The model dictionary [Printing type] settings must match the inspection item [OCR] settings.

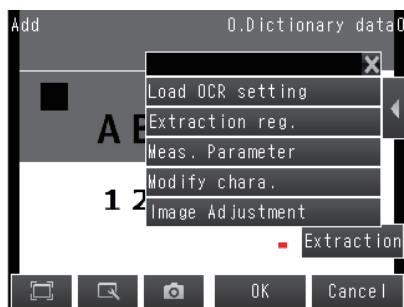

- 11 Press **[Extraction]**.

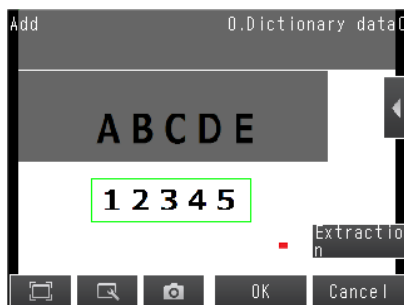

Note

The current filter item, or position correction item will be reflected in the extracted image.
To not reflect in this image. If this reflection is not necessary, touch - [Image Adjustment], and then select OFF.

- 12** The extracted characters will be displayed on the upper left of the display.

If characters are not displayed even you touch [Extraction] button, back Step 7 and retry to.

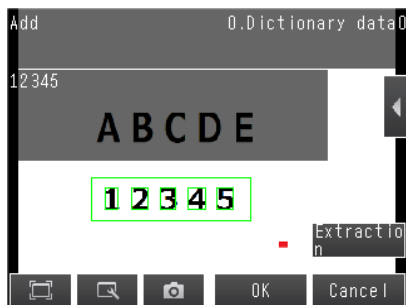

- 13** Press [OK] to register the characters.

- 14** The characters are registered for the corresponding character type.

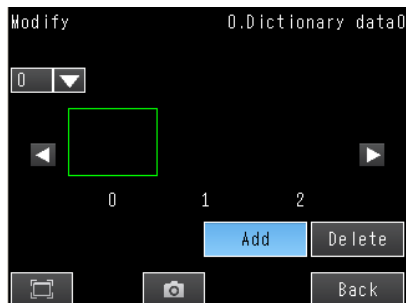

Error Messages during Registration

- Failed to register data. Character format is wrong.
The format or the number of characters did not match between the read character string and the registered character string. Correct the character string to register.
- Failed to register data. Character size is too small
You can register characters that are 30×30 pixels or larger in the dictionary. Change the settings of the Sensor to increase the size of the characters.
- Extraction error
Failed to extract the characters. Check the measurement parameter settings and the read region.
- Excess char. num
An attempt was made to register more than 10 characters. Delete the data that does not need to be registered.

Displaying Registered Characters

- 1 To display the registered characters, select the characters on the upper left of the display.

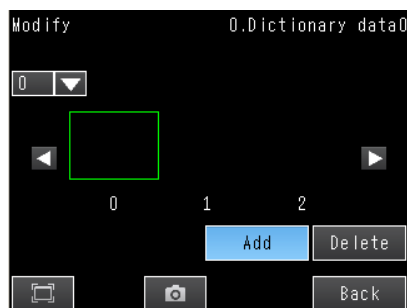

- 2 The registered characters will be displayed.



Deleting Registered Characters

- 1 Select the character that you want to delete in the customized dictionary registration display.



- 2 Press [Delete].

- 3 Press the [Yes] Button.

Setting Dictionary Parameters

► [Inspect] – [Inspection] – [Add item.] – [OCR] – [Details] Tab Page

1 Touch [Dictionary param.].

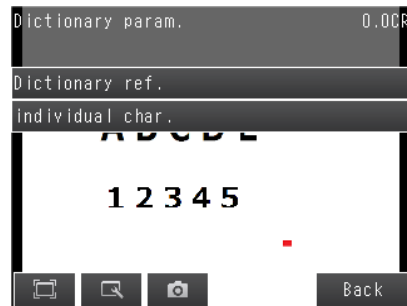

2 Touch [Dictionary ref.] and select the dictionary to use.

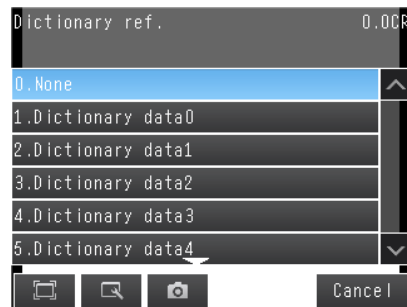

3 Touch [Individual char.] and select the figure numerical, alphabet, or symbol that you want to exclude from the reading target.



4 Press [Back].

Important

To apply the model dictionary settings, be sure to perform [Dictionary ref.] and [Individual char.].

Note

If the measurement results still do not stabilize after you have configured model dictionary settings, check the following:

- Make sure that appropriate dictionary data is selected in [Details] – [Dictionary param.] – [Dictionary ref.].

 *Setting the Measurement Parameters: p. 156*

- Make sure that [Meas. parameter] – [Printing type] in the model dictionary settings matches [Measurement] – [Printing type] in OCR inspection item.

 *Editing the Measurement Parameters: p. 172*

 *Setting the Measurement Parameters: p. 156*

Outputting Read Characters to an External Device

After a measurement, you can automatically output the character string that was read with the OCR inspection item to a PLC or other external device. The character strings are output after outputting the output data (output data settings 0 to 31), such as the inspection item parameters and calculation result.

Refer to the description for the communications format for the setting procedure and output specifications to output the character string.

 *Sensor FQ2-S/CH Series User's Manual for Communications Settings (Cat. No. Z338)*

- *Section 2 Controlling Operation and Outputting Data with a Parallel Connection*
- *Section 3 Controlling Operation and Outputting Data with an Ethernet Connection*
- *Section 4 Controlling Operation and Outputting Data with an RS-232C Connection*

Measurement Data That Can Be Used for External Outputs and Calculations

The following values can be used as measurement data and output to external devices via Ethernet or used in calculations.

Expression text string	Data name	Description	Data range
JG	Judgement	This is the judgement result.	-2: No judgment (not measured) 0: Judgment is OK -1: Judgment is NG -11: Model does not match -13: Measurement time out -16: Measurement timeout error, -17: Format not entered error
IN	Index	This is the verification result (i.e., the master data number).	-2: No verification pattern, or reading error -1: Verification is NG 0 to 31: Master data No.
N	Number of read characters	This is the total number of characters that were read for all four lines.	0 to 128
SIM	Similarity	This is the lowest similarity of the read characters.	0 to 100
STB	Stability	This is the lowest stability of the read characters.	0 to 100
N1	Number of read characters (line 1) N1	This is the number of read characters for line 1.	0 to 32
N2	Number of read characters (line 2) N2	This is the number of read characters for line 2.	0 to 32
N3	Number of read characters (line 3) N3	This is the number of read characters for line 3.	0 to 32
N4	Number of read characters (line 4) N4	This is the number of read characters for line 4.	0 to 32
SM	Individual similarity	This is the similarity of read character N (N = 0 to 127).	0 to 100
SB	Individual stability	This is the stability of read character N (N = 0 to 127).	0 to 100
SMC	Similarity (each character type)	Similarity level of loaded characters. (N= 0 to 39) N= 0 to 9: 0 to 9 10 to 35: A to Z 36: / (slash) 37: : (colon) 38 · 39; (,) (parenthesis)	0 to 100
SBC	Stability (each character type)	Stability level of loaded characters. (N= 0 to 39) N= 0 to 9: 0 to 9 10 to 35: A to Z 36: / (slash) 37: : (colon) 38 · 39; (,) (parenthesis)	0 to 100

Measurement Data That Can Be Logged for OCR

Parameter	Setting	Description
Judgement	-2: No judgment (not measured) 0: Judgment is OK -1: Judgment is NG -11: Model does not match -13: Measurement time out -16: Measurement timeout error, -17: Format not entered error	This is the judgment result.
Similarity	0 to 100	This is the lowest similarity of the read characters.
Stability	0 to 100	This is the lowest stability of the read characters.
Number of read characters on line 1	0 to 32	This is the number of characters that were read on line 1.
Number of read characters on line 2	0 to 32	This is the number of characters that were read on line 2.
Number of read characters on line 3	0 to 32	This is the number of characters that were read on line 3.
Number of read characters on line 4	0 to 32	This is the number of characters that were read on line 4.
Individual similarity	0 to 100	This is the similarity of read character N (N = 0 to 127).
Individual stability	0 to 100	This is the stability of read character N (N = 0 to 127).

4-5 Reading Barcodes

FQ2-S4

Bar Codes

You can read barcodes.

You can also verify if the character string that was read from the barcode matches a registered character string.

You can output the result of reading a barcode and the verification result to an external device.

The following ten code types can be read.

- JAN/EAN/UPC
 - Code39
 - Codabar (NW-7)
 - ITF (Interleaved 2 of 5)
 - Code 93
 - Code128/GS1-128
 - GS1 DataBar*
(Truncated, Stacked, Omni-directional, Stacked Omni-directional, Limited, Expanded, Expanded Stacked)
 - Pharmacode
 - GS1-128 Composite Code (CC-A,CC-B,CC-C)
 - GS1 DataBar Composite Code (CC-A,CC-B)
- * GS1 DataBar is a code in which the name has been changed from the previous RSS.

Note

Setup

Set the measurement region, place the applicable code in front of the Camera, and then perform teaching. The code type and the detailed parameters are set automatically.

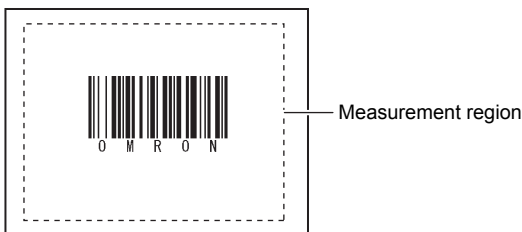

Measurement

One barcode is read in a single measurement region. When the measurement region contains multiple barcodes, the result of the first barcode to be read is output.*

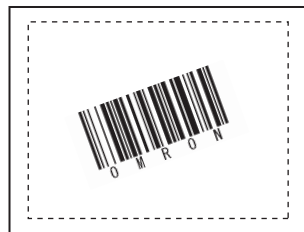

*: A Max.64 characters can be displayed on the result screen.
(Max.16 characters per line and Max.4 lines can be displayed.)

Important

Reading will end in error if the barcode type is incorrectly set. Set the barcode type before starting reading. When teaching is performed, the captured barcode is read, and the following items can be set:

- Code type *Detailed Parameters: p. 186*
- Direction (for Pharma only) *Detailed Parameters: p. 186*
- Reverse decode (for Pharma only) *Detailed Parameters: p. 186*

Setup Procedure for Bar Code

Step 1 Selecting the Inspection Item

► [Inspect] – [Inspection]

1 Press an unused inspection item number and press [Add item.].

2 Press [Bar code].

📖 4-3 Configuring Inspection Items: p. 138

Note

Drag the arrow (👉) at the bottom of the menu to display all of the inspection items.

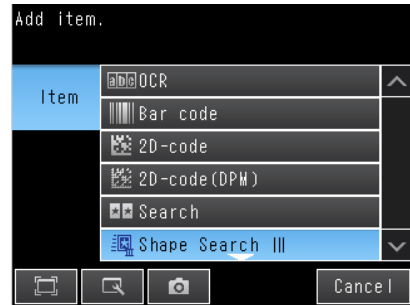

Step 2 Teaching

For teaching, the region to measure and the barcode within that region are set as read conditions. You can also register the contents that was read from the barcode as a verification condition in the master data.

► [Inspect] – [Inspection] – [Add item.] – [Bar code] – [Settings] Tab Page

📖 Step 3 Verification Conditions

1 Press [Teach].

2 Input an image of the barcode.

3 Move the rectangle so that it surrounds the barcode.

4 Press the [OK] Button.

5 The result of reading the barcode that was displayed will be displayed along with a confirmation dialog box for registration in the master data.

6 Press [Yes] to register the barcode read result in the master data.

The master data contains the character strings from the barcodes that are registered to verify whether the read character strings match specific character strings.

7 Press the master data in which the read characters will be registered.

8 Press [Back] to end teaching.

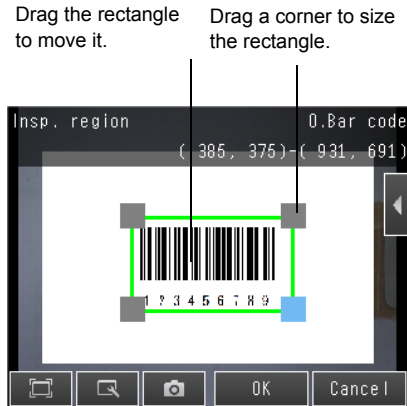

Note

You can use the menu commands that are displayed for  at the right of the display to adjust the settings that resulted from teaching.

- [Insp. region]: You can change the measurement region.
- [Camera setup]: You can adjust the Camera focus, brightness, and other factors to input a better image.

 *Adjusting Image Quality: p. 76*

- [Meas. Parameter]: You can change the type of code to read, the read settings, etc.

 *Detailed Parameters: p. 186*

- [Continuous test]: You can start test measurements of displayed images for the settings that were taught.

 *Performing Test Measurements: p. 340*

Step 3 Setting Verification Conditions

You can register a character string from a barcode to use it to verify that the character string that was read from a barcode matches the registered character string.

You can register up to 32 character strings for verification in the master data.

You can verify the character string in the inspection against up to 32 character strings that are registered in the master data.

The verification result is saved in an external reference parameter, so you can use a communications command to output it to an external device.

 *External Reference Parameters: p. 477*

► [Inspect] – [Inspection] – [Add item.] – [Bar code] – [Settings] Tab Page

- 1** Press [Verification].
- 2** Press [Master data regist.].
- 3** Press the character string to register in the master data.

- 4** You can use any of the following three methods to register character strings in the master data from the menu display.

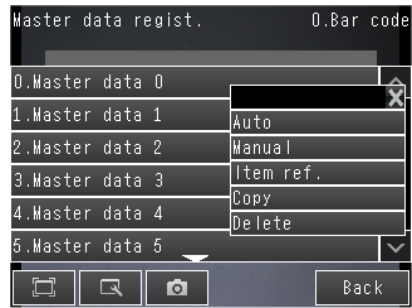

[Auto]: Registers a character string from an actual barcode in the master data. The procedure is essentially the same as the procedure for teaching in step 2.

[Manual]: Registers a character string that is entered directly in the master data. You can use a software keyboard to register a character string with up to 32 characters.

Note

Check the table of ASCII characters to see what characters can be registered. You cannot enter two-byte characters, one-byte Kana characters, and control codes. You can use the following characters as wildcards.

*: A wildcard for a character string of 0 or more characters

?: A wildcard for one character

 *ASCII code table: p. 185*

[Item ref.]: Select this item to use the immediately preceding read results as the verification character string. The following inspection items can be used as references: Bar code, 2D-code, 2D-code (DPM), and OCR. You cannot reference an inspection item at an item number that is after the item number of the inspection item that you are editing. When you register a character string from the master data, the item number of the inspection item that is being referenced, such as "Ref. 00," will be displayed.

Using Item References: p. 148

- 5** Repeat the above procedure to register more than one character string in the master data.
- 6** Press [Back] to return to the verification conditions screen.
- 7** Press [Verif. master data] and select the character string in the master data to use for verification.
- 8** Set the following verification conditions as required.

Setup Item	Setting Value	Description									
Verif. master data	OFF(Default)	Sets whether to verify the character string that was read from the barcode against a character string that is registered in the master data. To verify the read character string against the master data, select the character string to use for verification.									
	All master data										
	Master data 0 to 31										
Partial verif. on/off	No (Default)	The number of digits in the read results to be verified with the master data can be limited. When [Partial verification] is set to Yes, set the first and last compared digit positions. Up to 32 characters can be set as the number of digits.									
	Yes										
Partial Verif. setup	1 to 1024 Default First digit: 1, last digit: 1024)	<p>Example: First compared digit 2, last compared digit 6</p> <table border="1" style="margin-left: auto; margin-right: auto;"> <tr> <td>O</td><td>M</td><td>R</td><td>O</td><td>N</td><td>2</td><td>0</td><td>0</td><td>8</td> </tr> </table> <p style="text-align: center;"> ↑ 2nd digit 6th digit ↑ </p> <p>The text string used for verification becomes "MRON2". Manually register "MRON2", the comparison character string, in master data registration.</p>	O	M	R	O	N	2	0	0	8
O	M	R	O	N	2	0	0	8			
Master data regist.	---	Registers a character string in the master data. When using Partial verification, after automatically registering the master data, you should then adjust the data manually.									
External teach No.	Off (Default)	Sets the character string in which to automatically register the read result for teaching from an external device.									
	Master data 0 to 31										

9 Press [Back].

Note ASCII code table

The following table shows the ASCII codes that can be used for manual registration of master data and also for registering characters of Limits.

		Upper 4 bits					
Lower 4 bits		2	3	4	5	6	7
0	SP	0	@	P	`	p	
1	!	1	A	Q	a	q	
2	"	2	B	R	b	r	
3		3	C	S	c	s	
4		4	D	T	d	t	
5		5	E	U	e	u	
6	&	6	F	V	f	v	
7	'	7	G	W	g	w	
8		8	H	X	h	x	
9		9	I	Y	i	y	
A	*	:	J	Z	j	z	
B	+	;	K	[k	{	
C	,	<	L	¥	l	!	
D	-	=	M]	m	}	
E	.	>	N	^	n	~	
F	/	?	O	_	o		

Reflect in Total Judgment

You can specify whether to reflect the verification result of a barcode inspection item in the overall judgment. (The Default setting is [Yes].)

► **[Inspect]** – **[Inspection]** – **[Add item.]** – **[Bar code]** – **[Details]** – **[Output parameter]** – **[Reflect]**

Detail Settings

When you execute TEACH, the measurement parameters are automatically set according to the read cords.

► [Inspect] – [Inspection] – [Add item.] – [Bar code] – [Details] Tab Page

Press [Meas. parameter], and set the measurement parameters.

Be sure to always specify the code type. Specify other items as necessary. If master data is automatically registered, the code type, the composite codes on/off setting, and the read direction are automatically set.

Setup Item	Setting Value	Description
Code type	JAN/EAN/UPC (Default)	Selects the type of barcode to be read.
	Code39	
	Codebar	
	ITF	
	Code93	
	Code128/GS1-128	
	GS1 DataBar	
	Pharmacode	
Code color	Black (Default)	Sets the color of the code to be read.
	White	
Composite codes on/off	No (Default)	Sets whether or not to support composite codes. This item is enabled only when the following barcode types are selected: Code128/GS1-128, GS1 DataBar
	Yes	
Check digit on/off	No (Default)	Selects whether or not to insert a check digit. This item is enabled only when the following barcode types are selected: Codebar, Code39, ITF (Interleaved 2 of 5), JAN, EAN, UPC, or Code93. When the other codes are selected, this item is set to ON.
	Yes	
Direction	Horizontal mode (Default)	Selects the reading direction. This item is enabled only when Pharmacode is selected as the barcode type.
	Vertical mode	
Reverse on/off	No (Default)	Sets whether or not to use the reverse mode. This item is enabled only when Pharmacode is selected as the barcode type.
	Yes	
Timeout	1 to 9999 ms Default value: 9999	Sets the timeout time in read processing. A read error occurs if measurement does not end after the preset timeout time is exceeded.

Changing the Character String That Is Output for Read Errors

You can change the character string that is output for read errors.

- **[Inspect] – [Inspection] – [Add item.] – [Bar code] – [Details] Tab Page – [Output parameter] – [Error string]**

Setup Item	Setting Value	Description
Error string	Max. 20 digits (Default value: NG)	Sets the text string to be output when a read error occurs.  <i>ASCII code table: p. 185</i>

Changing the Items That Are Displayed on the Test Measurement and Run Display

- Press **[Test] – [Continuous test] – and then use  – [Display setting] on the Test Display.**

Display setting	Description
Num. of char.	Displays the number of characters that were read.
Characters	Displays the character string that was read.

Unstable Reading Results

Reading Is Unstable Due to Low Contrast

Adjust the brightness to improve the contrast of the bar code.

-  *Adjusting the Brightness: p. 77*

Outputting Read Characters to an External Device

After a measurement, you can automatically output the character string that was read with the barcode inspection item to a PLC or other external device. The character strings are output after outputting the output data (output data settings 0 to 31), such as the inspection item parameters and calculation result.

Refer to the description for the communications format for the setting procedure and output specifications to output the character string.

 *Vision Sensor FQ2-S/CH Series User's Manual for Communications Settings (Cat. No. Z338)*

- Section 2 Controlling Operation and Outputting Data with a Parallel Connection
- Section 3 Controlling Operation and Outputting Data with an Ethernet Connection
- Section 4 Controlling Operation and Outputting Data with an RS-232C Connection

Note

The read character string is output after the other output data (data 0 to 31 in the output data settings) after the measurement, such as the inspection item parameters and calculation results.

Refer to the following section for the location of the output area for the character string and other details.

 *Vision Sensor FQ2-S/CH Series User's Manual for Communications Settings (Cat. No. Z338)*
Section 1 Overview of Communication Specifications

Measurement Data That Can Be Used for External Outputs and Calculations

Expression text string	Data name	Description	Data range
JG	Judgment	This is the judgment result.	-2: No judgment (not measured) 0: Judgment is OK -1: Judgment is NG -16: Measurement timeout error
IN	Index	The verification result (master data No.) is output.	-2: No verification pattern, or reading error -1: Verification is NG, 0 to 31: Master data No.
N	Num. of characters	The number of characters read is output.	0 to 1024

Measurement Data That Can Be Logged (Bar Code)

The following values can be logged as measurement data.

Measured item	Range of value	Description
Judgement	-2: No judgement (not measured) 0: Judgement is OK -1: Judgement is NG -16: Measurement timeout error	This is the judgment result from the measurements.
Num. of characters	0 to 1024	The number of characters read is output.

*When logging data is output, the data is output in the order of the above table.

 7-6 Logging Measurement Data and Image Data: p. 392

Errors

Error in Teaching

If 2D-codes cannot be read during an automatic registration, a teaching error message is displayed. The reading may be unstable due to low contrast. Adjust the brightness to improve the contrast of the 2D-code.

Note *Adjusting the Brightness: p.77*

4-6 Reading 2D-codes

FQ2-S4

2D-codes

You can read 2D codes. You can also verify whether the character string that was read from the 2D code matches a registered character string. You can output the result of reading a 2D code and the verification result to an external device. The following five code types can be read.

Data Matrix (ECC200, GS1), QR Code, Micro QR Code, PDF417, or MicroPDF417

Note

Setup

Set the measurement region, place the applicable code in front of the Camera, and then perform teaching. The code type and the detailed parameters are set automatically.

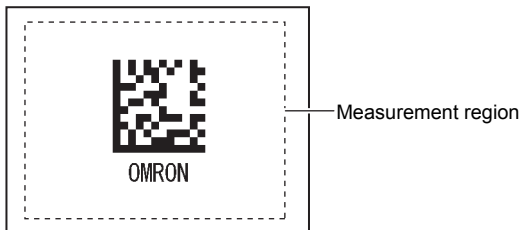

Measurement

One 2D barcode is read in a single measurement region. When the measurement region contains multiple 2D codes, the result of the first 2D code to be read is output.

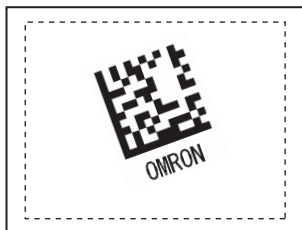

*: A Max.64 characters can be displayed on the result screen.
(Max.16 characters per line and Max.4 lines can be displayed.)

Important

Reading will end in error if the 2D Code type is incorrectly set. Set the code type before starting reading. When teaching is performed, the captured 2D code is read, and the following items can be set.

- Code type *Detailed Parameters: p. 196*
- Mirror *Detailed Parameters: p. 196*
- Specifying the Code Color (Data Matrix, QR Code, or Micro QR Code only) *Detailed Parameters: p. 196*
- Shape (Data Matrix, QR Code, or Micro QR Code only) *Detailed Parameters: p. 196*

Setup Procedure for 2D-code

Step 1 Selecting the Inspection Item

► [Inspect] – [Inspection]

1 Press an unused inspection item number and press [Add item.].

2 Press [2D-code].

📖 4-3 Configuring Inspection Items: p. 138

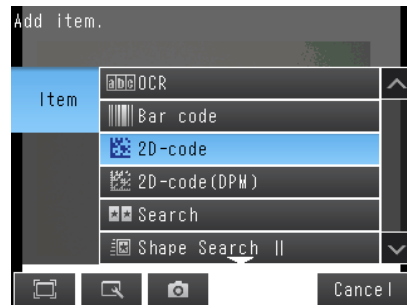

Note

Drag the arrow (🔽) at the bottom of the menu to display all of the inspection items.

Step 2 Teaching

For teaching, the region to measure and the 2D code within that region are set as read conditions. You can also register the contents that was read from the 2D code as a verification condition in the master data.

📖 Step 3 Verification Conditions: p. 194

► [Inspect] – [Inspection] – [Add item.] – [2D-code] – [Settings] Tab Page

1 Press [Teach].

2 Input an image of the 2D code.

3 Move the rectangle so that it surrounds the 2D code.

4 Press the [OK] Button.

5 Press [TEACH] on the lower right of the display.

6 The result of reading the 2D code that was displayed will be displayed along with a confirmation dialog box for registration in the master data.

7 Press [Yes] to register the read result in the master data.

The master data contains the character strings from the 2D codes that are registered to verify whether the read character strings match specific character strings.

8 Press the master data in which the read characters will be registered.

9 Press [Back] to end teaching.

Note

You can use the menu commands that are displayed for  at the right of the display to adjust the settings that resulted from teaching.

- [Insp. region]: You can change the measurement region.
- [Camera setup]: You can adjust the Camera focus, brightness, and other factors to input a better image.

 *Adjusting Image Quality: p. 76*

- [Meas. Parameter]: You can change the type of code to read, the read settings, etc.

 *Detailed Parameters: p. 196*

- [Continuous test]: You can start test measurements of displayed images for the settings that were taught.

 *Performing Test Measurements: p. 340*

Step 3 Judgement condition adjustment

Settings can be made to check whether the characters that were read from the workpiece were recognized correctly.

Differences between the references that were taught for 2D code reading and the actual result of 2D code reading are detected and conditions are set to determine how accurately 2D codes are read.

► [Inspect] – [Inspection] – [Add item.] – [2D-code] – [Settings] Tab Page

1 Press [Judgement].

2 Press a setting item to set the OK range.

Set a range for each of the setting items below.

Continuous measurement of the displayed image is executed.

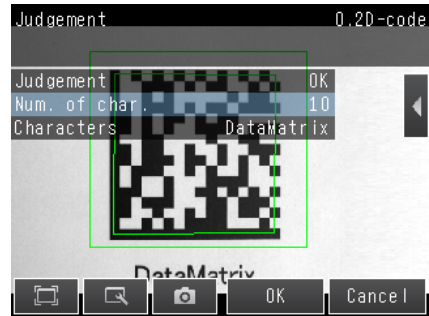

Note

The measurement values that are displayed on the screen can be changed in the display settings. Touch  – [Display settings] on the right side of the screen to display the display settings screen.

Measured item	Range of value	Description
Overall quality	Range: 0 to 4 Default value: Lower limit 0, upper limit 4	Can only be displayed and set when the code being read is Data Matrix and print quality is ON. Adjusts the upper and lower limits of the overall quality that is to be judged as OK.

3 Press [OK] to finalize.

Step 4 Setting Verification Conditions

You can register a character string from a 2D code to use it to verify that the character string that was read from a 2D code matches the registered character string. You can register up to 32 character strings for verification in the master data. You can verify the character string in the inspection against up to 32 character strings that are registered in the master data.

The verification result is saved in an external reference parameter, so you can use a communications command to output it to an external device.

 *External Reference Parameters: p. 477*

► [Inspect] – [Inspection] – [Add item.] – [2D-code] – [Settings] Tab Page

- 1 Press [Verification].
- 2 Press [Master data regist.].
- 3 Press the character string to register in the master data.
- 4 You can use any of the following three methods to register character strings in the master data from the menu display.

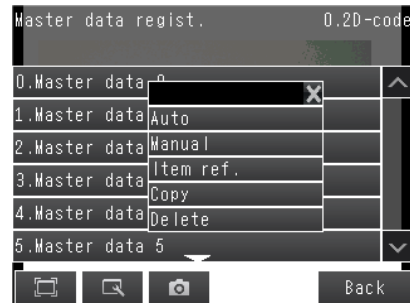

[Auto]: Registers a character string from an actual 2D code in the master data. The procedure is essentially the same as the procedure for teaching in step 2.

[Manual]: A character string is entered directly in the master data.
Select this menu when making a change to the master data registered using [Auto] menu.
You can use a software keyboard to register a character string with up to 32 characters.

Note

Check the table of ASCII characters to see what characters can be registered. You cannot enter two-byte characters, one-byte Kana characters, and control codes. You can use the following characters as wildcards.

*: A wildcard for a character string of 0 or more characters

?: A wildcard for one character

 *ASCII code table: p. 196*

[Item ref.]: Select this item to use the immediately preceding read results as the verification character string. The following inspection items can be used as references: Bar code, 2D-code, 2D-code (DPM), and OCR. You cannot reference an inspection item at an item number that is after the item number of the inspection item that you are editing. When you register a character string from the master data, the item number of the inspection item that is being referenced, such as "Ref. 00," will be displayed.

 *Using Item References: p. 148*

- 5 Repeat the above procedure to register more than one character string in the master data.
- 6 Press [Back] to return to the verification conditions screen.
- 7 Press [Verif. master data] and select the character string in the master data to use for verification.
- 8 Set the following verification conditions as required.

Setup Item	Setting Value	Description									
Verif. master data	OFF (Default)	Sets whether to verify the character string that was read from the barcode against a character string that is registered in the master data. To verify the read character string against the master data, select the character string to use for verification.									
	All master data										
	Master data 0 to 31										
Partial verif. on/off	No (Default)	The number of digits in the read results to be verified with the master data can be limited. When [Partial verification] is set to [Yes], set the first and last compared digit positions. Up to 32 characters can be set as the number of digits.									
	Yes										
Partial verif. setup	1 to 1024 (Default value first digit:1 last digit:1024)	<p>Example: First compared digit 2, last compared digit 6</p> <table border="1" style="margin-left: auto; margin-right: auto;"> <tr> <td style="padding: 2px;">O</td> <td style="padding: 2px;">M</td> <td style="padding: 2px;">R</td> <td style="padding: 2px;">O</td> <td style="padding: 2px;">N</td> <td style="padding: 2px;">2</td> <td style="padding: 2px;">0</td> <td style="padding: 2px;">0</td> <td style="padding: 2px;">8</td> </tr> </table> <p style="margin-left: 100px;">↑ ↑ 2nd digit 6th digit</p> <p>The text string used for verification becomes "MRON2". Manually register "MRON2", the comparison character string, in master data registration.</p>	O	M	R	O	N	2	0	0	8
O	M	R	O	N	2	0	0	8			
Master data regist.	---	Registers a character string in the master data. When you specify the vitrification range, adjust the data manually after executing the master data automatically.									
External teach No.	OFF (Default)	Sets the character string in which to automatically register the read result for teaching from an external device.									
	Master data 0 to 31										

- 9 Press [Back].

Note ASCII code table

The following table shows the ASCII codes that can be used for manual registration of master data and also for registering characters of Limits.

		Upper 4 bits					
		2	3	4	5	6	7
Lower 4 bits	0	S P	0	@	P	`	p
	1	!	1	A	Q	a	q
	2	”	2	B	R	b	r
	3		3	C	S	c	s
	4		4	D	T	d	t
	5		5	E	U	e	u
	6	&	6	F	V	f	v
	7	'	7	G	W	g	w
	8		8	H	X	h	x
	9		9	I	Y	i	y
	A	*	:	J	Z	j	z
	B	+	;	K	[k	{
	C	,	<	L	¥	l	!
	D	-	=	M]	m	}
	E	.	>	N	^	n	~
	F	/	?	O	_	o	

Reflect in Total Judgment

You can specify whether to reflect the verification result of a 2D code inspection item in the overall judgment. (The Default setting is [Yes].)

- ▶ **[Inspect]** – **[Inspection]** – **[Add item.]** – **[2D-code]** – **[Details] Tab Page** – **[Output parameter]** – **[Reflect]**

Detail Settings

When you execute TEACH, the measurement parameters are automatically set corresponded read code.

- ▶ **[Inspect]** – **[Inspection]** – **[Add item.]** – **[2D-code]** – **[Details] Tab Page**

Press [Meas. Parameter]

Set the measurement parameters.

Be sure to always specify the code type. When you automatically register matrix data, the code type, code color, data matrix shape, and reverse settings are set automatically.

Setup Item	Setting Value	Description
Code type	Data Matrix (Default)	Selects the type of 2D Code to be read.
	QR Code	
	MicroQR Code	
	PDF417	
	MicroPDF417	
Reverse	Normal (Default)	Sets normal or reverse as the image orientation.
	Reverse	This parameter is valid only one of the following code types is selected. Data Matrix, QR Code, or Micro QR Code
Code color	Black	Specifies the code color.
	White	This item is enabled only when the following barcode types are selected:
	Auto (Default)	Data Matrix, QR Code, MicroQR Code
Shape (Data Matrix)	Square (Default)	Specifies the code shape.
	Square or Rectangle	This item is enabled only when the following barcode types are selected: Data Matrix
Print quality (Data Matrix)	ON	Sets print quality evaluation ON/OFF.
	OFF (Default)	
Grid correction (MicroQR Code)	ON	Set whether grid correction is ON or OFF.
	OFF (Default)	
Timeout	1 to 9999 ms (Default: 9999)	Sets the timeout time in read processing. A read error occurs if measurement does not end after the preset timeout time is exceeded.

Outputting Read Characters to an External Device

After a measurement, you can automatically output the character string that was read with the 2D-code inspection item to a PLC or other external device. The character strings are output after outputting the output data (output data settings 0 to 31), such as the inspection item parameters and calculation result.

Refer to the description for the communications format for the setting procedure and output specifications to output the character string.

 *Vision Sensor FQ2-S/CH Series User's Manual for Communications Settings (Cat. No. Z338)*

- *Section 2 Controlling Operation and Outputting Data with a Parallel Connection*
- *Section 3 Controlling Operation and Outputting Data with an Ethernet Connection*
- *Section 4 Controlling Operation and Outputting Data with an RS-232C Connection*

Note

The read character string is output after the other output data (data 0 to 31 in the output data settings) after the measurement, such as the inspection item parameters and calculation results. Refer to the following section for the location of the output area for the character string and other details.

 *Vision Sensor FQ2-S/CH Series User's Manual for Communications Settings (Cat. No. Z338)*
Section 1 Overview of Communication Specifications

Changing the Character String That Is Output for Read Errors

You can change the character string that is output for read errors.

► **[Inspect] – [Inspection] – [Add item.] – [2D-code] – [Details] Tab Page – [Output parameter] – [Error string]**

Setup Item	Setting Value	Description
Error string	Max. 20 digits (Default value: NG)	Sets the text string to be output when a read error occurs.  <i>ASCII code table: p. 196</i>

Unstable Reading Results

Reading Is Unstable Due to Low Contrast

Adjust the brightness to improve the contrast of the 2D code.

 *Adjusting the Brightness: p. 77*

Measurement Data That Can Be Used for External Outputs and Calculations

Expression text string	Data name	Description	Data range
JG	Judgment	This is the judgment result.	-2: No judgment (not measured), 0: Judgment is OK 1: Judgment is NG -16: Measurement timeout error
IN	Index	The verification result (master data No.) is output.	-2: No verification pattern, or reading error -1: Verification is NG 0 to 31: Master data No.
N	Num. of characters	The number of characters read is output.	0 to 1024
GD0	Overall quality	Overall quality of 2D code. The lowest grade of the individual indices is the overall quality.	0 to 4
GD1	Decode	Evaluates whether decode was successful.	0 to 4
GD2	Cell contrast	Evaluates the difference between the average of the white cell density and the average of the black cell density.	0 to 4
GD3	Cell modulation	Evaluates the deviation of cell brightness.	0 to 4
GD4	Fixed pattern damage	Evaluates the degree of fixed pattern damage of the code.	0 to 4
GD5	Axial nonuniformity	Evaluates the degree of vertical and horizontal distortion of the code.	0 to 4
GD6	Grid nonuniformity	Evaluates the position deviation of each cell.	0 to 4
GD7	Unused err. Corr.	Evaluates the proportion of unused error correction during decode.	0 to 4
GD8	Print scale	Outputs the print scale.	0 to 4
GD9	Print scale X	Outputs the print scale X direction.	0 to 4
GD10	Print scale Y	Outputs the print scale Y direction.	0 to 4

Measurement Data That Can Be Logged (2D Code)

The following values can be logged as measurement data.

Measured item	Range of value	Description
Judgement	-2: No judgement (not measured) 0: Judgement is OK -1: Judgement is NG -16: Measurement timeout error	This is the judgment result from the measurements.
Num. of characters	0 to 1024	The number of characters read is output.
Overall quality	0 to 4	Outputs the evaluation value of overall quality.
Decode	0 to 4	Outputs the evaluation value of decode.
Cell contrast	0 to 4	Outputs the evaluation value of the contrast.
Cell modulation	0 to 4	Outputs the evaluation value of cell modulation.
Fixed pattern damage	0 to 4	Outputs the evaluation value of fixed pattern damage.
Axial nonuniformity	0 to 4	Outputs the evaluation value of axial nonuniformity.
Grid nonuniformity	0 to 4	Outputs the evaluation value of grid nonuniformity.
Unused err. Corr.	0 to 4	Outputs the evaluation value of unused error correction.
Print scale	0 to 4	Outputs the evaluation value of the print scale.
Print scale X	0 to 4	Outputs the evaluation value of print scale X.
Print scale Y	0 to 4	Outputs the evaluation value of print scale Y.

* When logging data is output, the data is output in the order of the above table.

 7-6 Logging Measurement Data and Image Data: p. 392

Errors

Errors in Teaching

If 2D-codes cannot be read during an automatic registration, a teaching error message is displayed. The reading may be unstable due to low contrast. Adjust the brightness to improve the contrast of the 2D-code.

 *Adjusting the Brightness: p. 77*

4-7 Reading 2D Codes (DPM)

FQ2-S4

2D Codes (DPM)

You can read DPM (direct part marking) 2D codes.

You can also verify whether the character string that was read from the 2D code matches a registered character string.

You can output the result of reading a 2D code and the verification result to an external device.

The scan result and verification result can be externally output.

Codes that can be scanned are Data Matrix (ECC200) and QR Codes.

The print quality evaluation result defined in ISO/IEC TR29158 can only be calculated for Data Matrix.

Setting image

When the inspection region is set, the code image is displayed, and teaching is executed, the code type and detailed parameters are automatically set.

Inspection image

One 2D code is scanned in one inspection region. If there are multiple 2D codes in the inspection region, the first scanned result is output.*

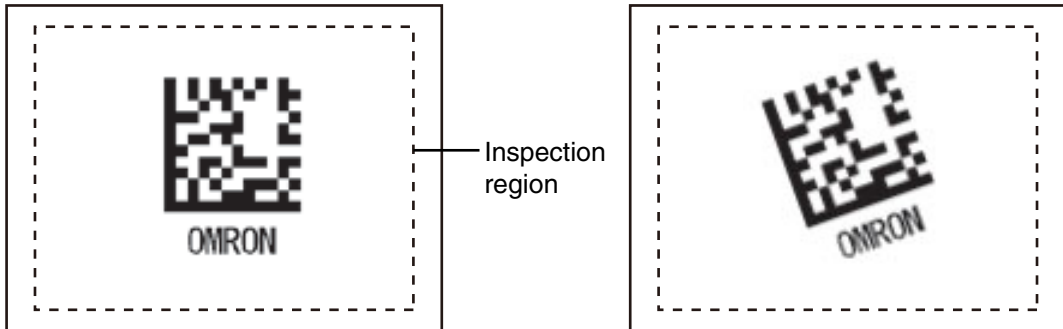

*: A Max.64 characters can be displayed on the result screen. (Max.16 characters per line and Max.4 lines can be displayed.)

Setup Procedure for 2D-code (DPM)

Step 1 Select the Inspection Item

► [Inspect] - [Modify]

1 Press an unused inspection item number and press [Add item.].

2 Press [2D-code (DPM)].

📖 4-3 *Configuring Inspection Items: p. 138*

Note

Drag the arrow () at the bottom of the menu to display all of the inspection items.

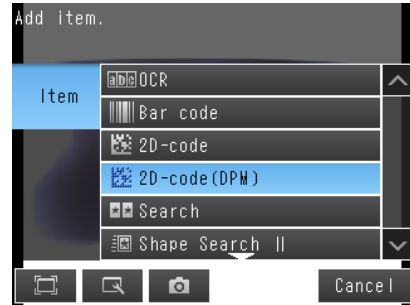

Step 2 Teaching

For teaching, the region to measure and the 2D code within that region are set as read conditions. You can also register the contents that was read from the 2D code as a verification condition in the master data.

 *Step 4 Setting the Verification Conditions: p. 207*

► [Inspect] - [Inspection] - [Add item.] - [2D-code (DPM)] - [Settings] Tab Page

1 Press [Teach].

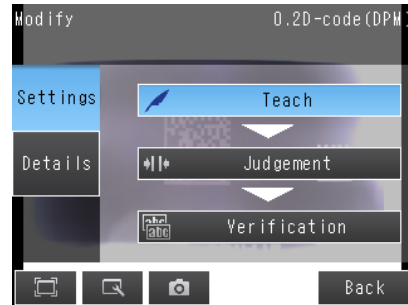

2 Display the image of the 2D code.

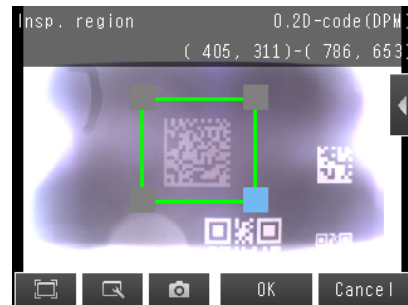

3 Move the rectangle so that it surrounds the 2D code.

4 Press the [OK] Button.

5 Press [TEACH] on the lower right of the display.



6 The result of reading the 2D code that was displayed will be displayed along with a confirmation dialog box for registration in the master data.

7 Press [Yes] to register the read result in the master data.

The master data contains the character strings from the 2D codes that are registered to verify whether the read character strings match specific character strings.

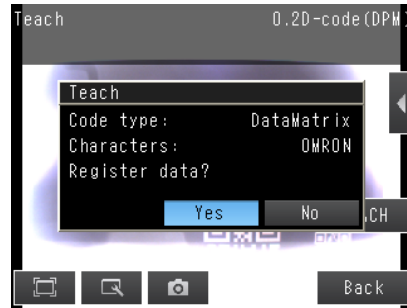

8 Press the master data in which the read characters will be registered.

9 Press [Back] to end teaching.

Note

You can use the menu commands that are displayed for  at the right of the display to adjust the settings that resulted from teaching.

- [Insp. region]: You can change the measurement region.
- [Camera setup]: You can adjust the Camera focus, brightness, and other factors to input a better image.

 *Adjusting Image Quality: p. 76*

- [Meas. Parameter]: You can change the type of code to read, the read settings, etc.

 *Detailed Parameters: p. 196*

- [Continuous test]: You can start test measurements of displayed images for the settings that were taught.

 *Performing Test Measurements: p. 340*

Step 3 Setting the Judgement Parameters

Settings are made to check whether the characters that were read from the workpiece were recognized correctly. Differences between the references that were taught for reading the 2D code and the actual result of reading the 2D code are detected and conditions are set to determine how accurately characters are read.

► [Inspect] - [Inspection] - [2D-code (DPM)] - [Settings] Tab Page

- 1 Press [Judgement].
- 2 Press each parameter and set the range that is to be judged as OK. Set the range for each of the following parameters.

Continuous measurements will be performed for the images that are displayed.

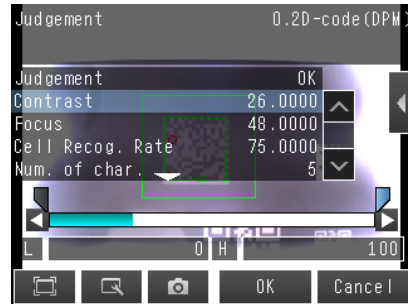

Note

- You can change measurement values that appear on the display on the Display Settings Display. Press – [Display setting] on the right of the display to switch to the Display Settings Display.
 - You can automatically adjust the judgement conditions by using OK and NG workpieces. 5-3 Adjusting the Judgment Parameters: p. 346
- Press – [Auto adjustment] on the right of the display to switch to the Auto adjustment Display.

Parameter	Setting	Description
Contrast	Range: 0 to 100 (Default)	Adjust the upper and lower limits of the contrast that is to be judged as OK. Cannot be displayed or set when DPM print quality is ON.
Focus	Range: 0 to 100 (Default)	Adjust the upper and lower limits of the focus that is to be judged as OK. Cannot be displayed or set when DPM print quality is ON.
Cell Recog. Rate	Range: 0 to 100 (Default)	Adjust the upper and lower limits of the cell recognition rate that is to be judged as OK. Cannot be displayed or set when DPM print quality is ON.
Overall quality	Range: 0 to 4 (Default)	Can only be displayed and set when the code being read is Data Matrix and DPM print quality is ON. Adjusts the upper and lower limits of the overall quality that is to be judged as OK.

Note

- Refer to the following information for Contrast, Focus and Cell Recog. Rate. Measurement Data That Can Be Used for External Outputs and Calculations: p. 213

3 Press [OK] to enter the values.

Note

You can specify whether to reflect the judgment result of the judgment conditions for character recognition in the overall judgment. (The Default is to reflect them.)

▶ **[Inspect] – [Inspection] – [Add item.] – [2D-code (DPM)] – [Details] Tab Page – [Output parameter] – [Reflect]**

Step 4 Setting the Verification Conditions

You can register a character string from a 2D code to use it to verify that the character string that was read from a 2D code matches the registered character string. You can register up to 32 character strings for verification in the master data.

You can verify the character string in the inspection against up to 32 character strings that are registered in the master data. The verification result is saved in an external reference parameter, so you can use a communications command to output it to an external device.

 9-2 External Reference Parameters: p. 477

► [Inspect] - [Inspection] - [Add item.] - [2D-code (DPM)] - [Settings] Tab Page

- 1 Press [Verification].
- 2 Press [Master data regist.].
- 3 Press the character string to register in the master data.
- 4 You can use any of the following three methods to register character strings in the master data from the menu display.



[Auto]: Registers a character string from an actual 2D code in the master data. The procedure is essentially the same as the procedure for teaching in step 2.

[Manual]: A character string is entered directly in the master data.
Select this menu when making a change to the master data registered using [Auto] menu.
You can use a software keyboard to register a character string with up to 32 characters.

Note

Check the table of ASCII characters to see what characters can be registered. You cannot enter two-byte characters, one-byte Kana characters, and control codes. You can use the following characters as wildcards.

*: A wildcard for a character string of 0 or more characters

?: A wildcard for one character

 *ASCII code table: p. 209*

[Item ref.]:

Select this item to use the immediately preceding read results as the verification character string. The following inspection items can be used as references: Bar code, 2D-code, 2D-code (DPM), and OCR. You cannot reference an inspection item at an item number that is after the item number of the inspection item that you are editing.

When you register a character string from the master data, the item number of the inspection item that is being referenced, such as "Ref. 00," will be displayed.

5 Press [Back] to return to the verification conditions screen.

6 Press [Verif. master data] and select the character string in the master data to use for verification.

7 Set the following verification conditions as required.

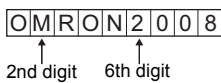
Parameter	Setting	Description
Verif. master data	<ul style="list-style-type: none"> • OFF (Default) • All master data Master data 0 to 31	Sets whether to verify the read character string against a character string that is registered in the master data. To verify the read character string against the master data, select the character string to use for verification.
Partial verif. on/off	No (Default) Yes	The number of digits in the read results to be verified with the master data can be limited. When [Partial verification] is set to [Yes], set the first and last compared digit positions. Up to 32 characters can be set as the number of digits.
Partial verif. setup	1 to 1024 Default value first digit:1 last digit:1024	Example: First compared digit 2, last compared digit 6  The text string used for verification becomes "MRON2". Manually register "MRON2", the comparison character string, in master data registration.
Master data regist.	---	Registers a character string in the master data. Use [Manual] menu when making a change to the [Partial verif. on/off] setting for master data originally registered by [Auto].
External teach No.	OFF (Default) Master data 0 to 31	Sets the character string in which to automatically register the read result for teaching from an external device.

8 Press [Back].

Note ASCII code table

The following table shows the ASCII codes that can be used for manual registration of master data and also for registering characters of Limits.

		Upper 4 bits					
		2	3	4	5	6	7
Lower 4 bits	0	SP	0	@	P	`	p
	1	!	1	A	Q	a	q
	2	”	2	B	R	b	r
	3		3	C	S	c	s
	4		4	D	T	d	t
	5		5	E	U	e	u
	6	&	6	F	V	f	v
	7	'	7	G	W	g	w
	8		8	H	X	h	x
	9		9	I	Y	i	y
	A	*	:	J	Z	j	z
	B	+	;	K	[k	{
	C	,	<	L	¥	l	!
	D	-	=	M]	m	}
	E	.	>	N	^	n	~
	F	/	?	O	_	o	

Detailed Parameters

When you execute TEACH, the measurement parameters are automatically set corresponded read code.

► **[Inspect] - [Inspection] - [Add item] - [2D-code (DPM)] - [Details] Tab Page - [Meas. Parameter]**

Measurement Parameters

Parameter	Setting	Description
Code type	DataMatrix QR Code Auto (Default)	Sets the type of code to be scanned.
Auto length	No Yes (Default)	Sets whether the code length is automatically acquired.
Size	50 to 480 (Default)	Sets the length of the code on the display. (pixels)
Reverse	Normal Reverse Auto (Default)	Sets normal image or reverse (mirror) image.
Code color	Black White Auto (Default)	Sets the color of the code.
Grid correction	ON OFF (Default)	Set whether grid correction is ON or OFF. You can set this for DataMatrix and for QR codes.
Fast mode	Yes No (Default)	Sets fast mode. When ON, the scanning time is shorter. For certain work, the scanning time may be longer when Fast mode is ON. Please use after performing test measurements and verifying the scanning speed.
Shape (DataMatrix only)	Square Rectangle Auto (Default)	Sets the code shape.
QR Code Model (QR Code only)	Model 1 Model 2 Auto (Default)	Sets the QR Code model.
Error Correction Level (QR Code only)	L (7%) M (15%) Q (25%) H (30%) Auto (Default)	Sets the error correction level (ECC level). (The ECC level of DataMatrix is fixed at 200.)
Cell (QR Code only)	21 × 21, 25 × 25, 29 × 29, 33 × 33, 37 × 37, 41 × 41, 45 × 45, 49 × 49, 53 × 53, 57 × 57, Auto (Default)	Sets the number of code cells.

Parameter	Setting	Description
Cell (DataMatrix only)	Shape: Square 10 × 10, 12 × 12, 14 × 14, 16 × 16, 18 × 18, 20 × 20, 22 × 22, 24 × 24, 26 × 26, 32 × 32, 36 × 36, 40 × 40, 44 × 44, 48 × 48, 52 × 52, 64 × 64, Auto (Default) Shape: Rectangle 8 × 18, 8 × 32, 12 × 26, 12 × 36, 16 × 36, 16 × 48, Auto (Default)	Sets the number of code cells.
DPM print quality (Data Matrix only)	ON OFF (Default)	Sets print quality ON/OFF.
Timeout	1 to 9999 ms (Default value: 9999)	Sets the timeout time in read processing. A read error occurs if measurement does not end after the preset time-out time is exceeded.

Important

- Measurement parameters other than [Grid correction], [Fast mode] and DPM print quality are initialized as set when [Teach] is pressed.
- When the "Code type" setting is changed, some settings are initialized as shown below.

Parameter	Initialized due to "Code type" change
Code type	Initialized
Auto length	
Size	Initialized
Reverse	
Code color	
Grid correction	
Fast mode	
Shape	Initialized
QR Code Model	Initialized
Error Correction Level	Initialized
Cell	Initialized
DPM print quality	

Outputting Read Characters to an External Device

After a measurement, you can automatically output the character string that was read with the DPM 2D code inspection item to a PLC or other external device. The character strings are output after outputting the output data (output data settings 0 to 31), such as the inspection item parameters and calculation result.

Refer to the description for the communications format for the setting procedure and output specifications to output the character string.

 *Vision Sensor FQ2-S/CH Series User's Manual for Communications Settings (Cat. No. Z338)*

- *Section 2 EtherNet/IP*
- *Section 3 PLC Link*
- *Section 4 TCP No-protocol Communications*

Changing the Character String That Is Output for Read Errors

You can change the character string that is output for read errors.

► **[Inspect] – [Inspection] – [Add item.] – [2D-code (DPM)] – [Details] Tab Page – [Output parameter] – [Error string]**

Setup Item	Setting Value	Description
Error string	Max. 20 digits (Default value: NG)	Sets the text string to be output when a read error occurs.  <i>ASCII code table: p. 209</i>

Measurement Data That Can Be Used for External Outputs and Calculations

Expression text string	Data name	Data range	Description
JG	Judgment	-2: No judgment (not measured) 0: Judgment is OK -1: Judgment is NG -16: Measurement timeout error	This is the judgment result.
IN	Index	-2: No verification pattern or reading error -1: Verification is NG 0 to 31: Master data No	The verification result (master data No.) is output.
N	Num. of characters	0 to 1024	The number of characters read is output.
E	Cell recognition rate	0 to 100	Value that lets you check the correction rate. The recognition rate is higher when the ratio of corrected characters to the total number of characters in the code is lower. When a code cannot be read, the value is 0.
C	Contrast	0 to 100	Indicates the contrast in a code. When the difference of contrast between light and shade in a code is bigger, the value of contrast become higher. When a code cannot be read, the value is 0.
F	Focus	0 to 100	Indicates the focus of the image using the change of density at cell edges. When out of focus, the code cannot be read. When the cell edges are sharper, the value of Focus become higher. When a code cannot be read, the value is 0.
P	Cell size	Depends on the size of the code.	Depends on the size of the code.
GDA0	Overall quality	0 to 4	Overall quality of 2D code based on ISO/IEC TR29158(AIM-DPM-1-2006). The lowest grade of the individual indices is the overall quality.
GDA1	Decode	0 to 4	Evaluates whether decode was successful.
GDA2	Cell contrast	0 to 4	Evaluates the difference between the average of the white cell density and the average of the black cell density.
GDA3	Cell modulation	0 to 4	Evaluates the deviation of cell brightness.
GDA4	Fixed pattern damage	0 to 4	Evaluates the degree of fixed pattern damage of the code.
GDA5	Axial nonuniformity	0 to 4	Evaluates the degree of vertical and horizontal distortion of the code.
GDA6	Grid nonuniformity	0 to 4	Evaluates the position deviation of each cell.
GDA7	Unused err. Corr.	0 to 4	Evaluates the proportion of unused error correction during decode.

Inspection Data that Can be Logged

The following values can be logged as inspection data.

Inspection item	Value range	Description
Judgement	-2: No judgement (not measured) 0: Judgement is OK -1: Judgement is NG -16: Measurement timeout error	This is the judgment result from the measurements.
Contrast	0 to 100	Outputs the contrast.
Focus	0 to 100	Outputs the focus.
Cell recognition rate	0 to 100	Outputs the cell recognition rate.
Num. of char.	0 to 1024	Outputs the number of characters that were detected.
Index	-2: No verification pattern, or reading error -1: Verification is NG, 0 to 31: Master data No.	Outputs the index.
Cell size	Depends on the size of the code.	Outputs the number of pixels per cell of the scanned code.
Overall quality	0 to 4	Outputs the evaluation value of overall quality.
Decode	0 to 4	Outputs the evaluation value of decode.
Cell contrast	0 to 4	Outputs the evaluation value of the contrast.
Cell modulation	0 to 4	Outputs the evaluation value of cell modulation.
Fixed pattern damage	0 to 4	Outputs the evaluation value of fixed pattern damage.
Axial nonuniformity	0 to 4	Outputs the evaluation value of axial nonuniformity.
Grid nonuniformity	0 to 4	Outputs the evaluation value of grid nonuniformity.
Unused err. Corr.	0 to 4	Outputs the evaluation value of unused error correction.

When logging data is output, the data is output in the order of the above table.

 7-6 Logging Measurement Data and Image Data: p. 392

If an Error Occurs

If a teaching error occurs

If scanning of the 2D code fails, a teaching error message appears.
It is likely that low contrast caused unstable scanning.
Adjust the brightness to increase the contrast of the 2D code.

 Adjusting the Brightness: p. 77

4-8 Inspecting with the Search Inspection Item

FQ2-S1

FQ2-S2

FQ2-S3

FQ2-S4

Search Inspection Item

This inspection item is used to perform inspections for shapes or for presence. The image pattern that is to be measured is registered in advance and measurements are performed to see if the pattern is present or if the shape is different.

The image pattern that is registered in advance is called the model.

The degree to which the image matches the model is called the correlation.

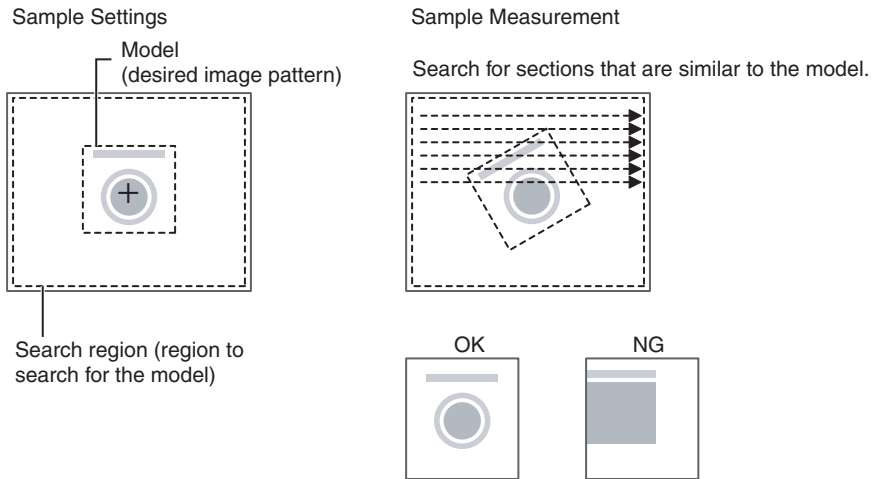

Setup Procedure for the Search Inspection Item

Step 1 Selecting the Inspection Item

► [Inspect] – [Inspection]

1 Press an unused inspection item number and press [Add item.].

2 Press [Search].

 *Registering inspection items: p. 138*

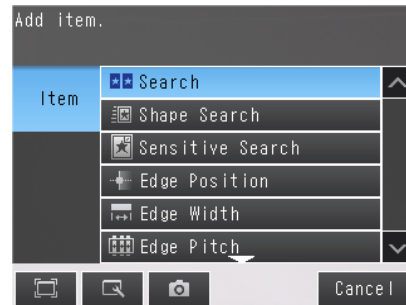

Note

Drag the arrow  at the bottom of the menu upward to display all of the inspection items.

Step 2 Teaching

Teaching means to store the region and partial image as reference data for the measurement.

► [Inspect] – [Inspection] – [Add item.] – [Search] – [Settings] Tab Page

1 Press [Teach].

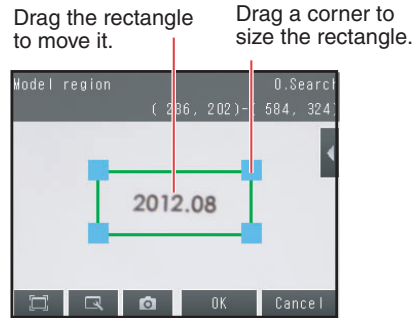

2 Place the object that is to be used as the measurement reference in front of the camera.

3 Move the rectangle to the location to be measured.

4 Press [OK].

5 Press [TEACH] on the lower right of the display.

The basic settings will be registered when teaching has been completed.

6 Press [Back] to end teaching.

The following data is stored as the measurement reference.

Item	Parameter	Description
Reference data	Model image	This is the partial image that is stored as the reference.
	Reference position X	These are coordinates of the model image that are stored as reference.
	Reference position Y	
	Reference Angle	The angle of the registered model.

Step 3 Adjusting Judgement Parameters

► [Inspect] – [Inspection] – [Add item.] – [Search] – [Settings] Tab Page

1 Press [Judgement].

2 Press each parameter and set the range that is to be judged as OK. Set the range for each of the following parameters.

Continuous measurements will be performed for the images that are taken.

Note

You can change the parameters for judgement conditions on the Display Settings Display.

Press [◀] – [Display setting] on the right of the display to switch to the Display Settings Display.

If more than one result was detected, you can switch to a display for each result. (Multi-point output must be enabled.)

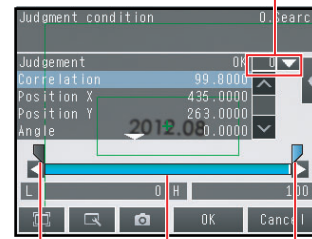

Upper limit Lower limit
Blue for OK. Red for NG.

3 Press [OK] to accept the value.

4 Press [Back] to end making the setting.

Parameter	Setting	Description
Correlation	Range: 0 to 100 Defaults: Lower: 60 Upper: 100	Adjust the upper and lower limits of the correlation for an OK judgment.
Position X	Range: -99,999.9999 to 99,999.9999 Defaults: Lower: -99,999.9999 Upper: 99,999.9999	Adjust the upper and lower limits of measurement position X for an OK judgment.
Position Y	Range: -99,999.9999 to 99,999.9999 Defaults: Lower: -99,999.9999 Upper: 99,999.9999	Adjust the upper and lower limits of measurement position Y for an OK judgment.
Angle	Range: -180 to 180 (Default) Defaults: Lower: -180 Upper: 180	Adjust the upper and lower limits of angle for an OK judgment.
Count	Range: 0 to 32 Defaults: Lower: 0 Upper: 32	Adjust the upper and lower limits of the detection count for an OK judgment.

Note

- You can change the output form for each measurement value to one of the following settings.
Press [◀] – [Result type] on the right of the display.
 - Absolute value (Default): The measured coordinates are output.
 - Relative value : The difference from the reference position is output as coordinates.
- Note the following when [Multi-point output] is enabled.
 - If [Candidate level] is higher than the lower value of the Judgment condition, [Candidate level] has higher priority.
 - If Correlating value is lower than [Candidate level], measurement result will be zero.

Increasing Measurement Position Accuracy

You can increase the accuracy of measurement positioning.
You can calculate down to four decimal places.

► [Inspect] – [Inspection] – [Search] – [Modify] – [Details] Tab Page – [Meas. Parameter]

1 Press [Sub-pixel] and select [Yes].

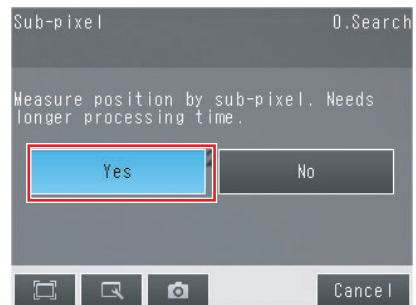

Obtaining Multiple Results Simultaneously

You can detect all items that satisfy the extraction conditions.
Judgment is performed for all detected results.

► [Inspect] – [Inspection] – [Search] – [Modify] – [Details] Tab Page – [Meas. Parameter]

1 Press [Multi-point output] and select [Yes].

2 Press [Sorting method] and select the conditions by which to sort the detected results.

You can output the results in the sort order that you selected.

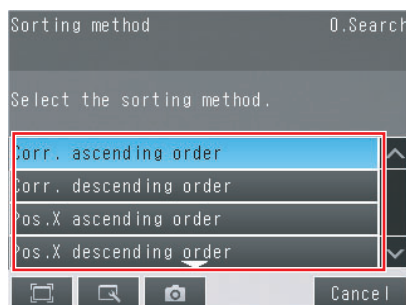

Note

You can specify the actual output conditions and count for outputting multiple results.

📖 *Selecting the results to output: p. 221*

Selection item	Setting	Description
Sorting method	Corr. ascending order (ascending order of correlation value)	Sorts the results in order from the smallest correlation to the largest. Candidate level has priority when Candidate level is lower than lower value of Judgment condition. Measurement value will be zero if the correlating value is lower than Candidate level.
	Corr. descending order (Default) (descending order of correlation value)	Sorts the results in order from the largest correlation to the smallest.
	Pos.X ascending order (ascending order of position X)	Sorts the results in order from the smallest measurement X position to the largest.
	Pos.X descending order (descending order of position X)	Sorts the results in order from the largest measurement X position to the smallest.
	Pos.Y ascending order (ascending order of position Y)	Sorts the results in order from the smallest measurement Y position to the largest.
	Pos.Y descending order (descending order of position Y)	Sorts the results in order from the largest measurement Y position to the smallest.

Select the Results to Output

You can use multiple conditions to determine which results to output from all the objects detected with a correlation at the candidate level or higher.

Only the results that meet all the specified conditions are output.

► [Inspect] – [Inspection] – [Search] – [Modify] – [Details] Tab Page – [Meas. Parameter]

- 1 Press [Extraction condition] and adjust the candidate level so that only objects higher than a certain correlation are detected.
- 2 If [Multi-point output] is set to [Yes], you can specify the output conditions for more than one result.
(Extraction X/Y and Detection count)

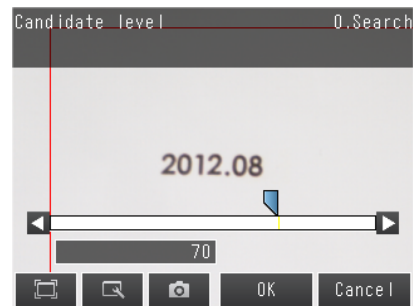

Extraction condition	Range	Description
Candidate level	Range: 0 to 100 Defaults: Lower: 70 Upper: 100	Set the threshold to find Candidate. Output the correlating value that is higher than [Candidate level] value. Decrease the value when Model search is unstable.
Extraction X	Range : -99999.9999 to 99999.9999 Defaults: Lower: -99999.9999 Upper: 99999.9999	Results are output only for objects with a measured X coordinate that is within this range.
Extraction Y	Range : -99999.9999 to 99999.9999 Defaults: Lower: -99999.9999 Upper: 99999.9999	Results are output only for objects with a measured Y coordinate that is within this range.
Detection count	Range: 1 to 32 Default: 32	Sets the maximum number of detection results to output.

Note

The processing time changes if you change the candidate level.

Reflect in Total Judgment

You can specify whether to reflect the judgment results of an inspection item in the overall judgment.
(The Default is to reflect them.)

▶ **[Inspect] – [Inspection] – [Add item.] – [Search] – [Details] Tab Page – [Output parameter]**

Unstable Search Results

Inclined Measurement Objects

Adjust the [Angle range] parameter to increase the range in which a search is made for the model.
The Search inspection item judges whether an image is OK or NG according to the correlation with a previously registered image pattern.

For this reason, if the object is at an angle, the correlation is reduced and the image may be judged as NG. To achieve an OK judgment for the same image pattern even when the object is at an angle, the rotation range must be widened.

▶ **[Inspect] – [Inspection] – [Search] – [Modify] – [Details] Tab Page – [Model parameter]**

- 1** Set [Rotation] to [Yes].
- 2** Press [Angle range] and set the following range.

Parameter	Setting	Description
Angle range	Range: -180 to 180 Default: Lower: -180 Upper: 180	A search is performed within the set angle range. The larger the angle range, the longer the processing time. Important If you change the angle range, perform teaching again.  p. 217

Correlation Is Inconsistent Due to Low Contrast

Adjust the brightness to improve the contrast of the mark.

 *Adjusting the Brightness: p. 77*

Correlation Is Inconsistent Due to Variations in the Measurement Object

Inconsistent portions can be masked so that they are omitted from matching.

 *Masking Parts of the Model: p. 226*

Correlation coefficient is zero

If the correlation coefficient is zero, reduce the Candidate level.

 *Select the Results to Output p. 221.*

Search a Different Place

If the measurement result does not stabilize, change the stability and precision as needed.
For better detection accuracy, the following two methods can be used.

- Set [Model mode] to [stable].
- Increase [Candidate level] value.

► [Inspect] – [Inspection] – [Search] – [Modify] – [Details] Tab Page – [Model parameter]

Parameter	Setting	Description
Stability	Range: 1 to 15 Default: 12	Sets whether priority is given to measurement stability or speed. If the speed is slow even when the stability is lowered, it is possible that many candidates are found. Raise the candidate level or increase the stability.
Precision	Range: 1 to 3 Default: 2	Sets whether priority is given to measurement position precision or speed. Increasing the precision gives priority to measurement position accuracy.

Increasing Processing Speed

The following two methods can be used to reduce processing time.

- **Reduce the range in which a search is performed for the model.**

📖 *Changing the measurement region: p. 227*

- **Reduce the angle range setting.**

Adjust the [Angle range] parameter to reduce the range in which a search for the model is performed.

📖 *Setting the angle range: p. 222*

- **Increase the [Candidate level] value and limit the models.**

📖 *Select the Results to Output: p. 221*

Editing the Model and Measurement Regions

This section describes how to edit the following regions.

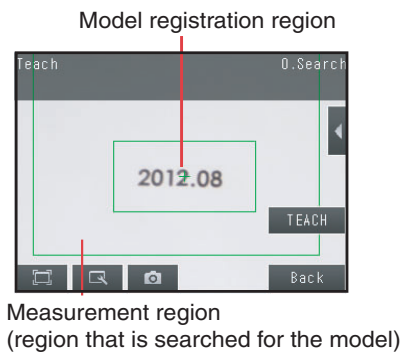

Important

If the model region is changed, perform teaching again. 📖 p. 217

Changing the Model Registration Region to a Shape Other Than a Rectangle

One rectangular region is registered as the Default model registration region.

Other than rectangles, circles and polygons can be set as the model registration regions.

► **[Inspect] – [Inspection] – [Search] – [Modify] – [Settings] Tab Page – [Teach] – [◀] – [Model region]**

1 Press [◀] – [Model region].

2 Press [◀] – [Delete] in the model registration editing display.

The rectangle will be deleted.

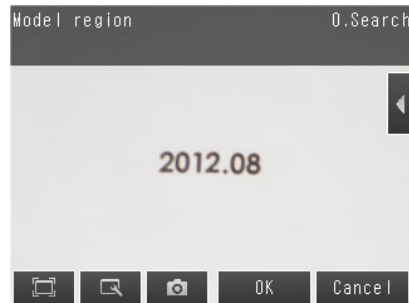

3 Press [Yes].

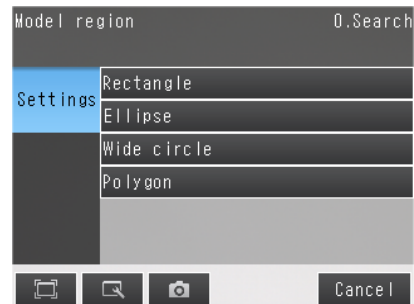

4 Press [Add] in [◀].

5 Press the shape of the region that you want to use.

6 Draw the region.

7 Press [OK].

Note

Up to 8 shapes can be combined to create a region for one model.

Masking Parts of the Model

The model registration region can be formed freely by combining enabled and disabled regions.

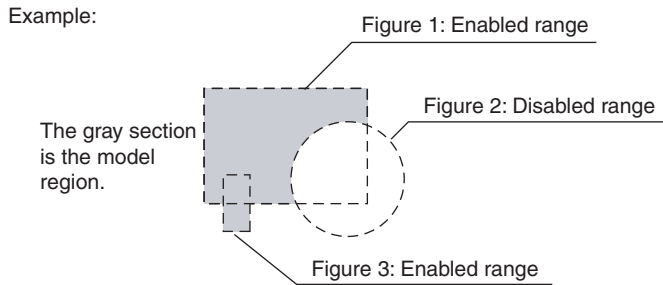

- [Inspect] – [Inspection] – [Search] – [Modify] – [Settings] Tab Page – [Teach] – [◀] – [Model region]

1 Draw the figure according to the section that you want to mask.

📖 p. 225

2 While the figure to be masked is selected, press [◀] on the right of the display and then press [OR/NOT]

The selected area will be removed from the model. Every time you press [OR/NOT], the area will switch between being enabled and disabled.

- OR : Enabled range
- NOT: Disabled range

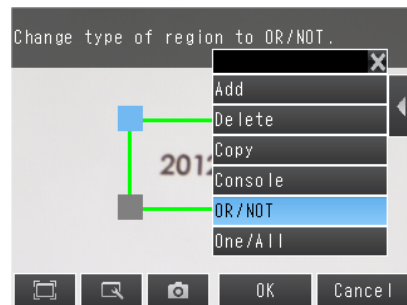

Fine-tuning the Position of the Region

This section describes the console which is useful to fine-tune the position of the measurement region or the model registration region in 1-pixel increments.

- [Inspect] – [Inspection] – [Search] – [Modify] – [Settings] Tab Page – [Teach] – [◀] – [Model region]

- 1** Press [◀] – [Console] on the right side of the display where you draw the region.

The console will appear.

- 2** To adjust the position of the figure, press within the frame. To adjust the size of the figure, press a corner of the figure.

- 3** Use the cross-key to align the figure with the search object.

The position of the figure can be adjusted by pressing the cross-key. Pressing it once will change the coordinate values by one pixel.

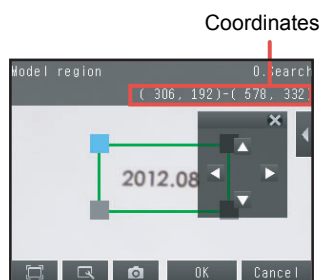

Changing the Measurement Region

The region within which the model is searched can be changed.

- [Inspect] – [Inspection] – [Search] – [Modify] – [Settings] Tab Page – [Teach]

- 1** Press [◀] – [Insp. region] on the right of the display.

The [Insp. region] Display will appear.

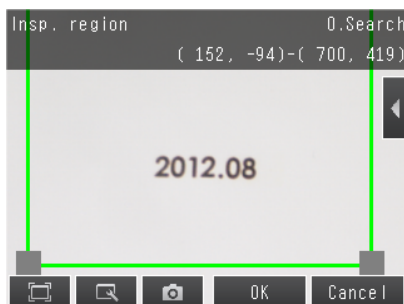

- 2** Adjust the size and position of the measurement region.

- Change the size.
Press the frame at one corner.
The processing time can be shortened by making the region smaller.
- Change the position.
Drag the figure to move it.

Changing Output Coordinate Positions

You can specify which part of the model to detect as coordinates during inspections. Normally, the center position of the registered model is used as the detection point.

- ▶ **[Inspect] – [Inspection] – [Search] – [Modify] – [Settings] Tab Page – [Teach] – [◀] – [Detection point]**

1 Use one of the following methods to move the cross cursor to the desired position.

The position of the cross cursor will be the coordinate position that is output. This position is registered relative to the model region.

- Drag the cross cursor to move it.
- Press [◀] – [Console] on the right of the display to display the console. You can use the cross cursor on the console to change the coordinate values one pixel at a time.

Drag the cross cursor.

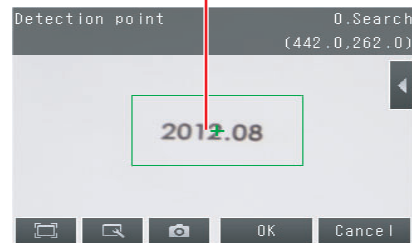

Note

The detection coordinates will automatically return to the center coordinates of the model if you change the model region.

Measurement Data That Can Be Used for External Outputs and Calculations

The following values can be used as measurement data and output to external devices via the Ethernet or used in calculations.

Expression text string	Data name	Description	Data range
JG	Judgement	-2: No judgment (not measured) 0: Judgment is OK -1: Judgment is NG -13: Teaching not performed error -14: Figure not registered error -15: Out of range error	This is the judgment result.
CR[0] to CR[31]	Correlation	0 to 100	This is the correlation of the Nth model that was found.
X[0] to X[31]	Position X	-99,999.9999 to 99,999.9999	This is the X coordinate where the Nth model was found.
Y[0] to Y[31]	Position Y	-99,999.9999 to 99,999.9999	This is the Y coordinate where the Nth model was found.
TH[0] to TH[31]	Angle	-180 to 180	This is the angle in which the Nth model was found.

Expression text string	Data name	Description	Data range
SX	Reference X	-99,999.9999 to 99,999.9999	This is the X coordinate of the position where the model was registered.
SY	Reference Y	-99,999.9999 to 99,999.9999	This is the Y coordinate of the position where the model was registered.
ST	Reference angle	-180 to 180	This is the angle when the model was registered.
RX	Detection coordinate X	-99,999.9999 to 99,999.9999	-99,999.9999 to 99,999.9999 This is the X coordinate of the detection point when the model was registered.
RY	Detection coordinate Y	-99,999.9999 to 99,999.9999	This is the Y coordinate of the detection point when the model was registered.
C	Count	0 to 32	This is the number of models found.

 4-18 Calculations and Judgments Using Inspection Item Data: p. 323

Measurement Data That Can Be Logged

The following values can be logged as measurement data.

Parameter	Range of value	Description
Judgement	0: Judgement is OK -1: Judgement is NG -13: Teaching not performed error -14: Figure not registered error -15: Out of range error	This is the measurement judgment results.
Correlation	0 to 100	This is the measured correlation.
Position X	-99999.9999 to 99999.9999	This is the measurement position X.
Position Y	-99999.9999 to 99999.9999	This is the measurement position Y.
Angle	-180 to 180	This is the measurement angle.
Count	0 to 32	This is the number of models found.

*When logging data is output, the data is output in the order of the above table.
If more than one item is stored, results are output for each model.

 7-6 Logging Measurement Data and Image Data: p. 392

Errors

Errors in Teaching

A teaching error message will appear if the contrast of the image within the model registration region is too low. Select a region with a larger contrast between light and dark areas compared to the region that was registered as the model and re-register it as the model.

4-9 Inspecting with the Shape Search III Inspection Item

FQ2-S1 FQ2-S2 FQ2-S3 FQ2-S4

Shape Search II Inspection Item

This function is for detecting user-defined target to estimate target position and pose precisely. The correlation value indicating the degree of similarity, measurement target position, and orientation can be output. In shape search III, edge information is used as features, whereas in a normal search mode, color and texture information are used.

It enables highly robust and fast detection robust to environmental variations including shadings, reflections, lightings, shape deformations, pose and noises.

Since state-of-the-art object detection algorithm is exploited in shape search III, it can provides much more reliable position and pose estimation with higher speed compared to shape search II. Furthermore, it has much more parameter to tune to support a wider variety of applications.

Sample Settings

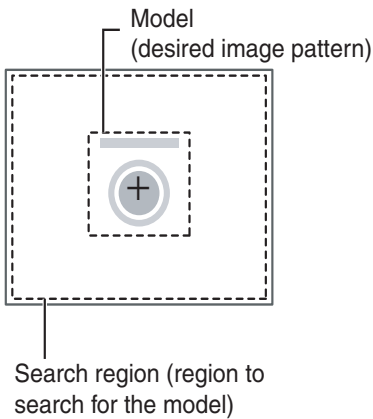

Sample Measurement

Search for sections that are similar to the model.

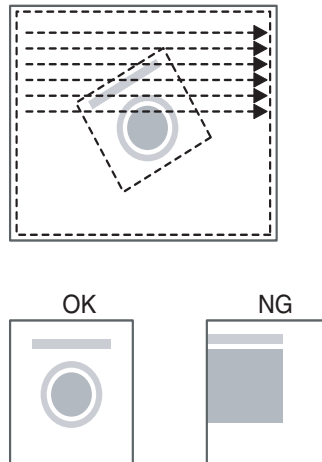

Setup Procedure for the Shape Search III Inspection Item

Step 1 Selecting the Inspection Item

► [Inspect] – [Inspection]

1 Press an unused inspection item number and press [Add item.].

2 Press [Shape Search III].

📖 *Registering inspection items: p. 138*

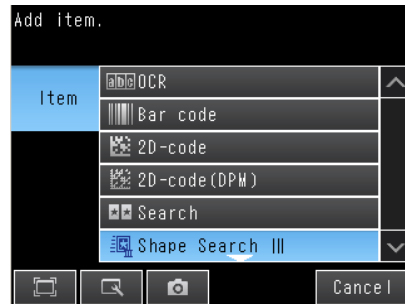

Note

Drag the arrow  at the bottom of the menu upward to display all of the inspection items.

Step 2 Teaching

Teaching means to store the region and partial image as reference data for the measurement.

► [Inspect] – [Inspection] – [Add item.] – [Shape Search III] – [Settings] Tab Page

1 Press [Teach].

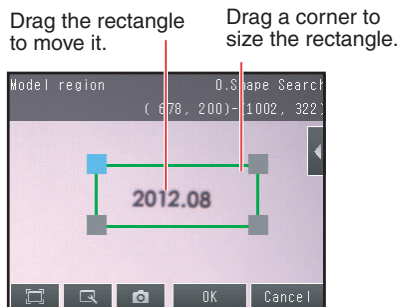

2 Place the object that is to be used as the measurement reference in front of the camera.

3 Move the rectangle to the location to be measured.

4 Press [OK].

5 Press [TEACH] on the lower right of the display.

The basic settings will be registered when teaching has been completed.





6 Press [Back] to end teaching.

The following data is stored as the measurement reference.

Item	Parameter	Description
Reference data	Model image	This is the partial image that is stored as the reference.
	Reference position X	These are coordinates of the model image that are stored as reference.
	Reference position Y	
	Reference angle	An angle when the model is registered.

Note

The following settings can be changed from the menus in the lower-right of the screen.

- [Model region]:  *Editing the Model and Measurement Regions p.224.*
 - [Insp. region] :  *Changing the Measurement Region p. 227*
 - [Detection point]:  *Changing Output Coordinate Positions p.228*
 - [Edge extraction]:  *When Edge cannot be detected at model region p.241*
 - [Display setting]: the following images can be selected.
 - Measurement image: displays the Measurement image.
 - Measurement image + Model image (Default): displays the detected Model on the Edge image.
 - Edge image: displays the Edge image.
 - Edge image + Model image: displays the detected Model on the Edge image.
 - Green: Model points matching with Edge image.
 - Yellow: Model points match with Edge image except for direction.
 - Red: Model points not matching with Edge image.
-

Step 3 Adjusting Judgment Parameters

► [Inspect] – [Inspection] – [Add item.] – [Shape Search] – [Settings] Tab Page

1 Press [Judgement].

2 Press each parameter and set the range that is to be judged as OK. Set the range for each of the following parameters.

Continuous measurements will be performed for the images that are taken.

If more than one result was detected, you can switch to a display for each result. (Multi-point output must be enabled.)

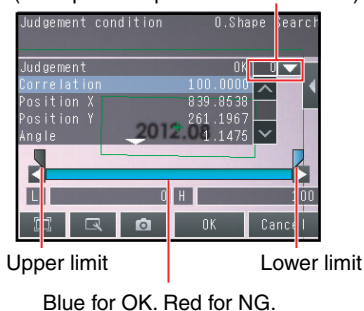

Note

You can change the parameters for judgement conditions on the Display Settings Display. Press [◀] – [Display setting] on the right of the display to switch to the Display Settings Display.

3 Press [OK] to accept the value.

4 Press [Back] to end making the setting.

Parameter	Setting	Description
Correlation	Range : 0 to 100 Defaults: Lower: 60 Upper: 100	Adjust the upper and lower limits of the correlation for an OK judgment. When the candidate level is higher than the judgment lower-limit value of correlation, the candidate level has priority. If the correlation value is lower than the candidate level, the measurement result is 0.
Position X	Range : -99,999.9999 to 99,999.9999 Defaults : Lower: -99,999.9999 Upper: 99,999.9999	Adjust the upper and lower limits of measurement position X for an OK judgment.
Position Y	Range : -99,999.9999 to 99,999.9999 Defaults : Lower: -99,999.9999 Upper: 99,999.9999	Adjust the upper and lower limits of measurement position Y for an OK judgment.
Angle	Range: -180 to 180 Defaults: Lower: -180 Upper: 180	Adjust the upper and lower limits of angle for an OK judgment.
Count	Range : 0 to 32 Defaults: Lower: 0 Upper: 32	Adjust the upper and lower limits of the detection count for an OK judgment.

Note

- You can change the output form for each measurement value to one of the following settings.
 - Press [◀] – [Result type] on the right of the display.
 - Absolute value (Default): The measured coordinates are output.
 - Relative value: The difference from the reference position is output as coordinates.
- [Display setting]: the following images can be selected.
 - Measurement image: displays the Measurement image.
 - Measurement image + Model image (Default): displays the detected Model on the Edge image.
 - Edge image: displays the Edge image.
 - Edge image + Model image: displays the detected Model on the Edge image.
 - Green: Model points matching with Edge image.
 - Yellow: Model points match with Edge image except for direction.
 - Red : Model points not matching with Edge image.

Obtaining Multiple Results Simultaneously

You can detect all items that satisfy the extraction conditions.
Judgment is performed for all detected results.

- **[Inspect] – [Inspection] – [Shape Search III] – [Modify] – [Details] Tab Page – [Meas. Parameter]**

- 1 Press **[Sorting method]** and select the conditions by which to sort the detected results.

You can output the results in the sort order that you selected.

Note

You can specify the actual output conditions and count for outputting multiple results.

 *Selecting the results to output: p. 237*

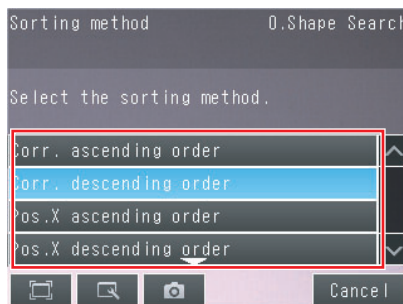

Selection item	Setting	Description
Sorting method	Corr. ascending order (ascending order of correlation value)	Sorts the results in order from the smallest correlation to the largest. Candidate level has priority when Candidate level is lower than lower value of Judgment condition. Measurement value will be zero if the correlating value is lower than Candidate level.
	Corr. descending order (Default) (descending order of correlation value)	Sorts the results in order from the largest correlation to the smallest.
	Pos.X ascending order (ascending order of position X)	Sorts the results in order from the smallest measurement X position to the largest.
	Pos.X descending order (descending order of position X)	Sorts the results in order from the largest measurement X position to the smallest.
	Pos.Y ascending order (ascending order of position Y)	Sorts the results in order from the smallest measurement Y position to the largest.
	Pos.Y descending order (descending order of position Y)	Sorts the results in order from the largest measurement Y position to the smallest.

Exclude the Overlapping Detected Result

- [Inspect] – [Inspection] – [Shape Search III] – [Modify] – [Details] Tab Page – [Meas. Parameter]

1 Touch [Overlay judgment], and then select [Yes].

2 Set Overlay rejection.

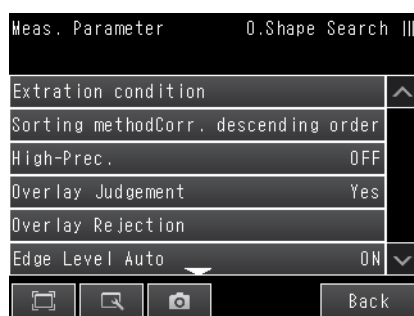

Extraction condition	Setting	Description
Overlay Judgement	Yes No (Default)	When you find the overlapped result, set the Overlay judgment to Yes.
Overlay Rejection	0 to 100 (Default: 100)	This parameter is acceptable when the Overlay judgment is Yes. Set the overlay level to remove, If you want to remove small overlay, increase this parameter.

Select the Results to Output

You can use multiple conditions to determine which results to output from all the objects detected with a correlation at the candidate level or higher.

Only the results that meet all the specified conditions are output.

► **[Inspect] – [Inspection] – [Shape Search III] – [Modify] – [Details] Tab Page – [Meas. Parameter]**

1 Press [Extraction condition] and adjust the candidate level so that only objects higher than a certain correlation are detected.

2 Set the conditions for outputting the detected objects.
(Extraction X/Y and Detection Count)

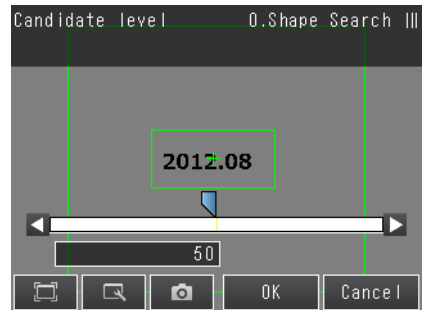

Extraction condition	Range	Description
Candidate level	0 to 100 Default: 50	Set the threshold to find Candidate. Output only a value that is higher than [Candidate level]. Increase the value if Model search is unstable.
Extraction X	–99999.9999 to 99999.9999 Defaults: Lower: –99,999.9999 Upper: 99,999.9999	Results are output only for objects with a measured X coordinate that is within this range.
Extraction Y	–99999.9999 to 99999.9999 Defaults: Lower: –99,999.9999 Upper: 99,999.9999	Results are output only for objects with a measured Y coordinate that is within this range.
Detection count	1 to 32 Default: 1	Sets the maximum number of detection results to output.

Note

The processing time changes if you change the candidate level.

Reflect in Total Judgment

You can specify whether to reflect the judgment results of an inspection item in the overall judgment. The Default is to reflect them.

- ▶ **[Inspect] – [Inspection] – [Add item.] – [Shape Search III] – [Details] Tab Page – [Output parameter]**

Unstable Shape Search III Results

Inclined Measurement Objects

The search area for the model can be expanded by adjusting [Angle range].

The OK or NG Judgment is determined by the correlation to the registered image pattern for the search. Therefore, there may be an NG judgment result for good workpiece if the correlation is low due to the angle being slanted.

In this case, to get an OK judgment, increase the Angle range.

- ▶ **[Inspect] – [Inspection] – [Shape Search III] – [Modify] – [Details] Tab Page – [Model parameter]**

- 1 Set [Rotation] to [Yes].**
- 2 Press [Angle range] and set the following range.**

Parameter	Setting	Description
Angle range	Range: -180 to 180 Default: Lower: -180 Upper: 180	A shape search II is performed within the set angle range. The larger the angle range, the longer the processing time. Important If you change the angle range, perform teaching again.  p. 232

When the Edge cannot be detected correctly

If you cannot detect the Edge correctly, adjust the Edge parameters.

- [Inspect] – [Inspection] – [Shape Search III] – [Modify] – [Details] Tab Page – [Measure parameter]

1 Touch [Edge level auto], and then select [OFF].

2 Set [Edge level].

Meas. Parameter	0.Shape Search III
Extraction condition	
Sorting method	Corr. descending order
High-Prec.	OFF
Overlay Judgement	No
Edge Level Auto	ON
Acceptable Dist. Level	
	

Parameter	Setting	Description
Edge level auto	ON (Default) OFF	This setting will be enabled to set automatically by selecting ON. If edge recognition results are not good with this setting, set to OFF.
Edge level	0 to 1024 (Default: 30)	This setting will be enabled if [Edge level auto] is OFF. Set the lower limit to recognize the [Edge level]. Edges higher than set value are recognized. Decrease the setting value when it is difficult to find edges. Increase the setting value when the effect of noise is high.

When the variability of good work pieces is large.

- Increase the Candidate level

If the mis-detection occurs, i.e. detects same shape with workpiece, the targets can be detected too much. Adjust the correlating value of target or increase the Candidate level.

 *Select the Results to Output: p. 221*

The size difference of work piece is large

If the correlation value is significantly lower when the variation of target shapes may be large, increase the Acceptable distortion level.

- ▶ **[Inspect] - [Inspection] - [Add item.] - [Shape Search III] - [Details] tab page - [Meas. Parameter]**

1 Touch [Acceptable Dist. level].

2 Set the [Acceptable Dist. level].

Parameter	Setting	Description
Acceptable distortion level	0: Low 1: Medium 2: High	Selects the degree of influence of correlation values when Model edge has small uneven patterns. To avoid reduction of correlation value, set [High] in this item.

Search other place

If the model image consists of detailed graphic images, similar models may be detected. For more accurate detection, consider the followings.

- ▶ **[Inspect] – [Inspection] – [Shape Search III] – [Modify] – [Details] Tab Page – [Model parameter] – [Model mode]**

Parameter	Setting	Description
Model mode	Stable (Default) Fast	This function is enabled for color images only. • Stable: Creates the model image using RGB colors, • Fast: Creates the model image using one color of RGB. When the shape is same, but the color differs, the detection can be unstable.

• Increase the Candidate level

If the mis-detection occurs, i.e. detects same shape with workpiece, the targets can be detected too much. Adjust the correlating value of target or increase the Candidate level.

 *Select the Results to Output: p. 221*

When Edge cannot be detected at model region

Change the Edge setting when the Edge cannot be detected at Model registration or the detected Edge is broken. After changing the Edge setting, retry to register the Model.

► [Inspect] - [Inspection] - [Add item.] - [Shape Search III] - [Settings] tab page - [Teach]

- 1 Touch  [Edge setting] on the upper-right window.

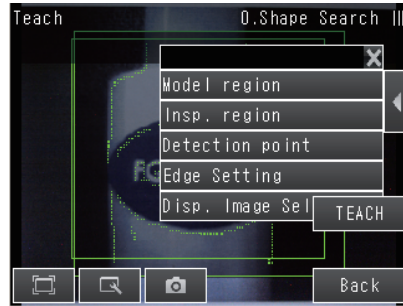

- 2 Set each item.

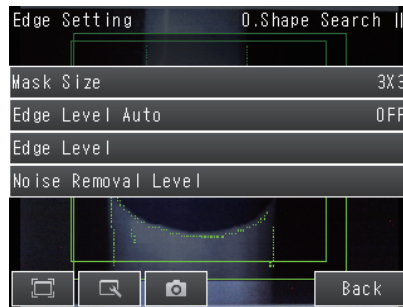

Parameter	Setting	Description
Mask size	<ul style="list-style-type: none"> • 3×3 (Default) • 5×5 • 7×7 	Select the range of pixels which are used to extract the edge. With a larger mask size, search is less affected by variation in pixels.
Edge level: Auto	<ul style="list-style-type: none"> • ON (Default) • OFF 	Select this check box to adjust [Edge level] automatically. If edges are not detected under the auto settings, clear this check box and adjust value of [Edge level].
Edge level	0 to 1024 Default: 20	This setting is enabled when the [Auto] check box is cleared in the [Edge setting] area. Set the lower limit of edge level to recognize as edge. Edges are recognized when their edge level is above this value. The smaller the value, the easier it is to find edges. The larger the value, the less noise will affect finding edges.
Noise removal level	0 to 100 Default: 0	Specify the upper limit of noise level to eliminate. Noise whose noise level is below this value will be eliminated. In the noise removal process, edges are connected and divided into a set of groups of line segments, and then these line segments are removed one by one from shorter segments. Setting a larger value removes larger noise.

Correlation Is Inconsistent Due to Low Contrast

Adjust the brightness to improve the contrast of the mark.

 *Adjusting the Brightness: p. 77*

Correlation Is Inconsistent Due to Variations in the Measurement Object

Inconsistent portions can be masked so that they are omitted from matching.

 *Model masking: p. 226*

Correlation coefficient is zero

If the correlation coefficient is zero, reduce the Candidate level.

 *Select the Results to Output: p. 221*

Increasing Processing Speed

The following two methods can be used to reduce processing time.

- **Reduce the range in which a shape search III is performed for the model.**

 *Changing the Measurement Region: p. 227*

- **Reduce the Angle range setting.**

Adjust the [Angle range] parameter to reduce the range in which a shape search II for the model is performed.

 *Select the Results to Output: p. 237*

- **Raise [Candidate level].**

Raise [Candidate level], then processing time will be shortened.

 *Select the Results to Output p. 221*

- **Set the Model region as small as possible.**

Raise [Candidate level], then processing time will be shortened.

 *Step 2 Teaching: p.142*

Judgment is NG (Insufficient memory)

The measurement region is possible to use large memory.

Set the measurement region as smaller as possible.

- **Set the measurement region to be small.**

 *Changing the Measurement Region: p. 227*

- **Set the model region to be small.**

The model size is possible to use large memory.

Set the model region as smaller as possible.

Editing the Model Regions and Measurement Region

Changing the Model Regions

This section describes how to edit the model regions.

You can edit the model region in the same way as for a search region.

Changing the Model Registration Region to a Shape Other Than a Rectangle:  p. 225

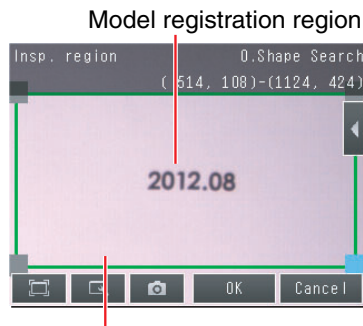

Measurement region
(region that is searched for the model)

Important

If the model region is changed, perform teaching again.  p. 232

Measurement Data That Can Be Used for External Outputs and Calculations

The following values can be used as measurement data and output to external devices via the Ethernet or used in calculations.

Expression text string	Data name	Data range	Description
JG	Judgment	-2: No judgement (not measured) 0: Judgement is OK -1: Judgement is NG -10: Image error -13: Teaching not performed error -14: Figure not registered error -15: Out of range error	This is the judgment result.
CR[0] to CR[31]	Correlation	0 to 100	This is the correlation of the Nth model that was found.
X[0] to X[31]	Position X	-99999.9999 to 99999.9999	This is the X coordinate where the Nth model was found.
Y[0] to Y[31]	Position Y	-99999.9999 to 99999.9999	This is the Y coordinate where the Nth model was found.
TH[0] to TH[31]	Angle	-180 to 180	This is the angle in which the Nth model was found.
SX	Reference X	-99,999.9999 to 99,999.9999	This is the X coordinate of the position where the model was registered.
SY	Reference Y	-99,999.9999 to 99,999.9999	This is the X coordinate of the position where the model was registered.
ST	Reference angle	-180 to 180	This is the angle when the model was registered.
RX	Detection coordinate X	-99,999.9999 to 99,999.9999	This is the X coordinate of the detection point when the model was registered.
RY	Detection coordinate Y	-99,999.9999 to 99,999.9999	This is the Y coordinate of the detection point when the model was registered.
C	Count	This is the number of models found.	0 to 32

 4-18 Calculations and Judgments Using Inspection Item Data: p. 323

Measurement Data That Can Be Logged

The following values can be logged as measurement data.

Parameter	Range of value	Description
Judgement	0: Judgement is OK -1: Judgement is NG -10: Image error -13: Teaching not performed error -14: Figure not registered error -15: Out of range error	This is the measurement judgment results.
Correlation	0 to 100	This is the measured correlation.
Position X	-99999.9999 to 99999.9999	This is the measurement position X.
Position Y	-99999.9999 to 99999.9999	This is the measurement position Y.
Angle	-180 to 180	This is the measurement angle.
Count	0 to 32	This is the number of models found.

* When logging data is output, the data is output in the order of the above table.
If more than one item is stored, results are output for each model.

 7-6 Logging Measurement Data and Image Data: p. 392

Errors

Errors in Teaching

A teaching error message will appear if the contrast of the image within the model registration region is too low. Select a region with a larger contrast between light and dark areas compared to the region that was registered as the model and re-register it as the model.

4-10 Inspecting with the Shape Search II Inspection Item

FQ2-S1 FQ2-S2 FQ2-S3 FQ2-S4

Shape Search II Inspection Item

This inspection item is used to search for the portion of the input image that most closely resembles an image pattern that is called a model. The model is registered in advance based on a characteristic feature of the measurement object.

You can output the correlation, which tells how closely the portion of the image matches the model. You can also output the position of the measurement object and the angle of the measurement object. For the normal Search inspection item, a model that concentrates on the color and brightness of the image pattern is used, but in the Shape Search II, a model that concentrates on the outline information is used.

This inspection item enables robust, high-speed, high-precision detection of models even when lighting is reflected from the workpieces, when the shapes of the workpieces are inconsistent, when the orientation of the workpieces change, when noise is superimposed, when part of the image is blocked, or when there are other fluctuations in the environment.

Sample Settings

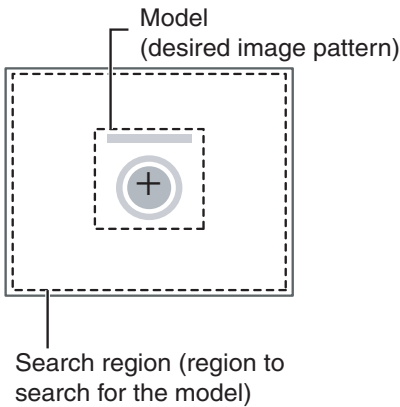

Sample Measurement

Search for sections that are similar to the model.

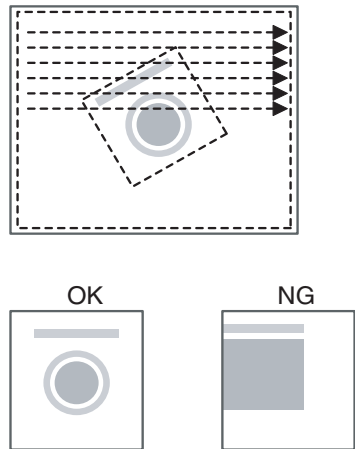

Setup Procedure for the Shape Search II Inspection Item

Step 1 Selecting the Inspection Item

► [Inspect] – [Inspection]

1 Press an unused inspection item number and press [Add item.].

2 Press [Shape Search II].

 *Registering inspection items: p. 138*

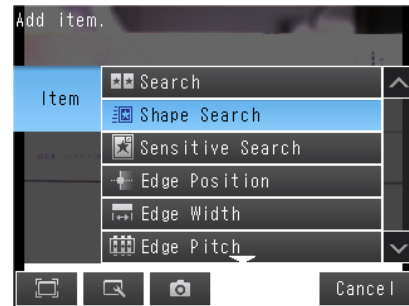

Note

Drag the arrow  at the bottom of the menu upward to display all of the inspection items.

Step 2 Teaching

Teaching means to store the region and partial image as reference data for the measurement.

► [Inspect] – [Inspection] – [Add item.] – [Shape Search II] – [Settings] Tab Page

1 Press [Teach].

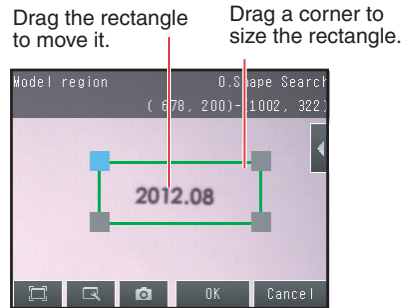

2 Place the object that is to be used as the measurement reference in front of the camera.

3 Move the rectangle to the location to be measured.

4 Press [OK].

5 Press [TEACH] on the lower right of the display.

The basic settings will be registered when teaching has been completed.

6 Press [Back] to end teaching.

The following data is stored as the measurement reference.

Item	Parameter	Description
Reference data	Model image	This is the partial image that is stored as the reference.
	Reference position X	These are coordinates of the model image that are stored as reference.
	Reference position Y	
	Reference Angle	The angle of the registered model.

Step 3 Adjusting Judgment Parameters

► [Inspect] – [Inspection] – [Add item.] – [Shape Search] – [Settings] Tab Page

1 Press [Judgement].

2 Press each parameter and set the range that is to be judged as OK. Set the range for each of the following parameters.

Continuous measurements will be performed for the images that are taken.

If more than one result was detected, you can switch to a display for each result. (Multi-point output must be enabled.)

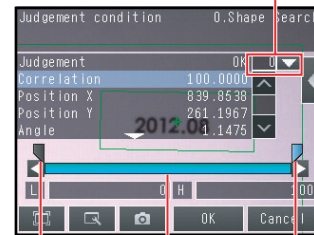

Upper limit Lower limit

Blue for OK. Red for NG.

Note

You can change the parameters for judgement conditions on the Display Settings Display. Press [◀] – [Display setting] on the right of the display to switch to the Display Settings Display.

3 Press [OK] to accept the value.

4 Press [Back] to end making the setting.

Parameter	Setting	Description
Correlation	Range : 0 to 100 Defaults: Lower: 60 Upper: 100	Adjust the upper and lower limits of the correlation for an OK judgment.
Position X	Range : -99,999.9999 to 99,999.9999 Defaults : Lower: -99,999.9999 Upper: 99,999.9999	Adjust the upper and lower limits of measurement position X for an OK judgment.
Position Y	Range : -99,999.9999 to 99,999.9999 Defaults : Lower: -99,999.9999 Upper: 99,999.9999	Adjust the upper and lower limits of measurement position Y for an OK judgment.
Angle	Range: -180 to 180 Defaults: Lower: -180 Upper: 180	Adjust the upper and lower limits of angle for an OK judgment.
Count	Range : 0 to 32 Defaults: Lower: 0 Upper: 32	Adjust the upper and lower limits of the detection count for an OK judgment.

Note

- You can change the output form for each measurement value to one of the following settings. Press [◀] – [Result type] on the right of the display.
 - Absolute value (Default): The measured coordinates are output.
 - Relative value: The difference from the reference position is output as coordinates.

Obtaining Multiple Results Simultaneously

You can detect all items that satisfy the extraction conditions.
Judgment is performed for all detected results.

- ▶ **[Inspect] – [Inspection] – [Shape Search II] – [Modify] – [Details] Tab Page – [Meas. Parameter]**

1 Press [Sorting method] and select the conditions by which to sort the detected results.

You can output the results in the sort order that you selected.

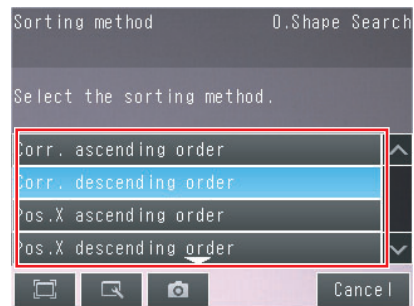

Note

You can specify the actual output conditions and count for outputting multiple results.

 *Selecting the results to output: p. 237*

Selection item	Setting	Description
Sorting method	Corr. ascending order (ascending order of correlation value)	Sorts the results in order from the smallest correlation to the largest. Candidate level has priority when Candidate level is lower than lower value of Judgment condition. Measurement value will be zero if the correlating value is lower than Candidate level.
	Corr. descending order (Default) (descending order of correlation value)	Sorts the results in order from the largest correlation to the smallest.
	Pos.X ascending order (ascending order of position X)	Sorts the results in order from the smallest measurement X position to the largest.
	Pos.X descending order (descending order of position X)	Sorts the results in order from the largest measurement X position to the smallest.
	Pos.Y ascending order (ascending order of position Y)	Sorts the results in order from the smallest measurement Y position to the largest.
	Pos.Y descending order (descending order of position Y)	Sorts the results in order from the largest measurement Y position to the smallest.

Select the Results to Output

You can use multiple conditions to determine which results to output from all the objects detected with a correlation at the candidate level or higher.

Only the results that meet all the specified conditions are output.

► **[Inspect] – [Inspection] – [Shape Search II] – [Modify] – [Details] Tab Page – [Meas. Parameter]**

1 Press [Extraction condition] and adjust the candidate level so that only objects higher than a certain correlation are detected.

2 Set the conditions for outputting the detected objects.
(Extraction X/Y and Detection Count)

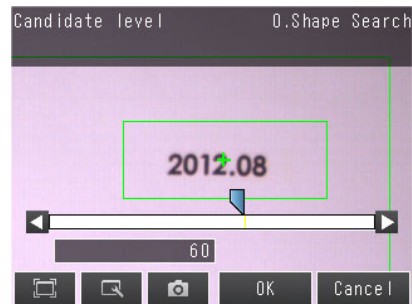

Extraction condition	Range	Description
Candidate level	0 to 100 Default: 80	Set the threshold to find Candidate point. Output only a value that is higher than [Candidate level]. Increase the value if Model search is unstable.
Extraction X	–99999.9999 to 99999.9999 Defaults: Lower: –99,999.9999 Upper: 99,999.9999	Results are output only for objects with a measured X coordinate that is within this range.
Extraction Y	–99999.9999 to 99999.9999 Defaults: Lower: –99,999.9999 Upper: 99,999.9999	Results are output only for objects with a measured Y coordinate that is within this range.
Detection count	1 to 32 Default: 1	Sets the maximum number of detection results to output.

Note

The processing time changes if you change the candidate level.

Reflect in Total Judgment

You can specify whether to reflect the judgment results of an inspection item in the overall judgment. The Default is to reflect them.

- ▶ **[Inspect] – [Inspection] – [Add item.] – [Shape Search II] – [Details] Tab Page – [Output parameter]**

Unstable Shape Search II Results

Inclined Measurement Objects

Adjust the [Angle range] parameter to increase the range in which a search is made for the model. The Shape Search II inspection item judges whether an image is OK or NG according to the correlation with a previously registered image pattern.

For this reason, if the object is at an angle, the correlation is reduced and the image may be judged as NG. To achieve an OK judgment for the same image pattern even when the object is at an angle, the rotation range must be widened.

- ▶ **[Inspect] – [Inspection] – [Shape Search II] – [Modify] – [Details] Tab Page – [Model parameter]**

1 Set [Rotation] to [Yes].

2 Press [Angle range] and set the following range.

Parameter	Setting	Description
Angle range	Range: -180 to 180 Default: Lower: -180 Upper: 180	A shape search II is performed within the set angle range. The larger the angle range, the longer the processing time. Important If you change the angle range, perform teaching again.  p. 232

Searching for Other Locations

If the model image consists of detailed graphic images, similar models may be detected.
For more accurate detection, consider the followings.

- Set [Model mode] to [Stable]
- Raise [Candidate level].
- Increase the Candidate level
Increasing the [Candidate level], limit the detected model.

For [Candidate level], refer to  *Select the Results to Output: p. 221*

► [Inspect] – [Inspection] – [Shape Search II] – [Modify] – [Details] Tab Page – [Model parameter] – [Model mode]

Parameter	Setting	Description
Model mode	Stable (Default) Fast	This function is only valid for color images. Stable: Creates a model using the three RGB colors. Fast : Creates a model using only one of the RGB colors. Detection is occasionally unstable for workpieces with the same shape but a different color.

Correlation Is Inconsistent Due to Low Contrast

Adjust the brightness to improve the contrast of the mark.

 *Adjusting the Brightness: p. 77*

Correlation Is Inconsistent Due to Variations in the Measurement Object

Inconsistent portions can be masked so that they are omitted from matching.

 *Masking Parts of the Model: p. 226*

Correlation coefficient is zero

If the correlation coefficient is zero, reduce the Candidate level.

 *Select the Results to Output: p. 221.*

Increasing Processing Speed

The following two methods can be used to reduce processing time.

- **Reduce the range in which a shape search II is performed for the model.**

 *Changing the Model Regions: p. 227*

- **Reduce the angle range setting.**

Adjust the [Angle range] parameter to reduce the range in which a shape search II for the model is performed.

 *Select the Results to Output: p. 237*

- **Raise [Candidate level].**

Raise [Candidate level], then processing time will be shortened.

 *Select the Results to Output: p. 221*

Editing the Model Regions and Measurement Region

Changing the Model Regions

This section describes how to edit the model regions.

You can edit the model region in the same way as for a search region.

Changing the Model Registration Region to a Shape Other Than a Rectangle:  p. 225

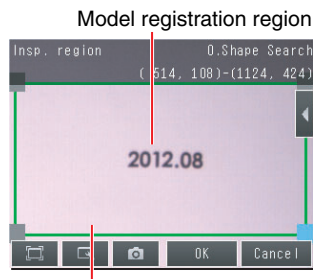

Measurement region
(region that is searched for the model)

Important

If the model region is changed, perform teaching again.

 p. 232

Changing the Measurement Region

The region within which the model is searched can be changed. You can edit the measurement region in the same way as for a search region.

Changing the Measurement Region:  p. 227

Measurement Data That Can Be Used for External Outputs and Calculations

The following values can be used as measurement data and output to external devices via the Ethernet or used in calculations.

Expression text string	Data name	Description	Data range
JG	Judgment	-2: No judgement (not measured) 0: Judgement is OK -1: Judgement is NG -13: Teaching not performed error -14: Figure not registered error -15: Out of range error	This is the judgment result.
CR[0] to CR[31]	Correlation	0 to 100	This is the correlation of the Nth model that was found.
X[0] to X[31]	Position X	-99999.9999 to 99999.9999	This is the X coordinate where the Nth model was found.
Y[0] to Y[31]	Position Y	-99999.9999 to 99999.9999	This is the Y coordinate where the Nth model was found.
TH[0] to TH[31]	Angle	-180 to 180	This is the angle in which the Nth model was found.
SX	Reference X	-99,999.9999 to 99,999.9999	This is the X coordinate of the position where the model was registered.
SY	Reference Y	-99,999.9999 to 99,999.9999	This is the Y coordinate of the position where the model was registered.
ST	Reference angle	-180 to 180	This is the angle when the model was registered.
RX	Detection coordinate X	-99,999.9999 to 99,999.9999	This is the X coordinate of the detection point when the model was registered.
RY	Detection coordinate Y	-99,999.9999 to 99,999.9999	This is the Y coordinate of the detection point when the model was registered.
C	Count	0 to 32	This is the number of models found.

 4-18 Calculations and Judgments Using Inspection Item Data: p. 323

Measurement Data That Can Be Logged

The following values can be logged as measurement data.

Parameter	Range of value	Description
Judgement	0: Judgement is OK -1: Judgement is NG -13: Teaching not performed error -14: Figure not registered error -15: Out of range error	This is the measurement judgment results.
Correlation	0 to 100	This is the measured correlation.
Position X	-99999.9999 to 99999.9999	This is the measurement position X.
Position Y	-99999.9999 to 99999.9999	This is the measurement position Y.
Angle	-180 to 180	This is the measurement angle.
Count	0 to 32	This is the number of models found.

* When logging data is output, the data is output in the order of the above table.
If more than one item is stored, results are output for each model.

 7-6 Logging Measurement Data and Image Data: p. 392

Errors

Errors in Teaching

A teaching error message will appear if the contrast of the image within the model registration region is too low. Select a region with a larger contrast between light and dark areas compared to the region that was registered as the model and re-register it as the model.

4-11 Inspecting with the Sensitive Search Inspection Item

FQ2-S1 FQ2-S2 FQ2-S3 FQ2-S4

Sensitive Search Inspection Item

This inspection item automatically divides the registered model into smaller areas and performs matching for details. The lowest correlation for all of the divisions is output.

A sensitive search is suitable when the differences between the model image and measurement image are too small to produce differences in correlations with a normal search.

Sample Settings

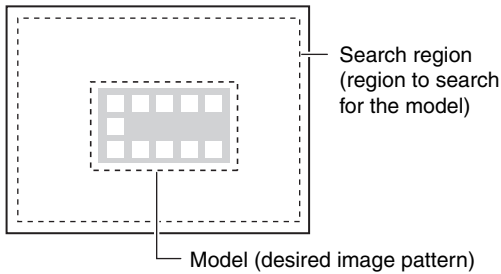

Sample Measurement

A search is made for sections that are similar to the model and then a finely divided model is used to check the correlations in detailed divisions. If there is no pattern in the divided model, then you can inspect the degree by which there is no pattern.

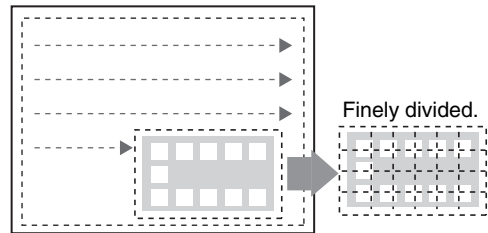

Setup Procedure for the Sensitive Search Inspection Item

Step 1 Selecting the Inspection Item

► [Inspect] – [Inspection]

- 1** Press an unused inspection item number and press [Add item.].
- 2** Press [Sensitive Search].

 *Registering inspection items: p. 138*

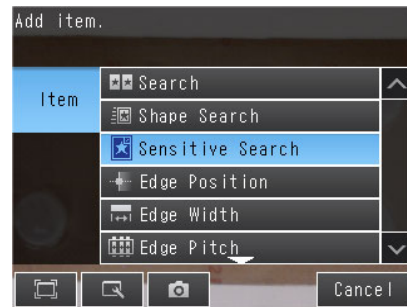

Note

Drag the arrow  at the bottom of the menu upward to display all of the inspection items.

Step 2 Teaching

Teaching means to store the region and partial image as reference data for the measurement.

► [Inspect] – [Inspection] – [Add item.] – [Sensitive Search] – [Settings] Tab Page

1 Press [Teach].

Drag the rectangle to move it. Drag a corner to size the rectangle

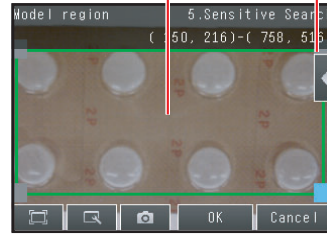

2 Place the object that is to be used as the measurement reference in front of the camera.

3 Move the rectangle to the location to be measured.

4 Press [OK].

5 Press [TEACH] on the lower right of the display.

The basic settings will be registered when teaching has been completed.

6 Press [Back] to end teaching.

The following data is stored as the measurement reference.

Item	Parameter	Description
Reference data	Model image	This is the partial image that is stored as the reference.
	Reference position X	These are coordinates of the model image that are stored as reference.
	Reference position Y	

Step 3 Adjusting Judgement Parameters

► [Inspect] – [Inspection] – [Add item.] – [Sensitive Search] – [Settings] Tab Page

1 Press [Judgement].

2 Press each parameter and set the range that is to be judged as OK. Set the range for each of the following parameters.

Continuous measurements will be performed for the images that are taken.

Note

You can change the parameters for judgment conditions on the Display Settings Display.

Press [◀] – [Display setting] on the right of the display to switch to the Display Settings Display.

3 Press [OK] to accept the value.

4 Press [Back] to end making the setting.

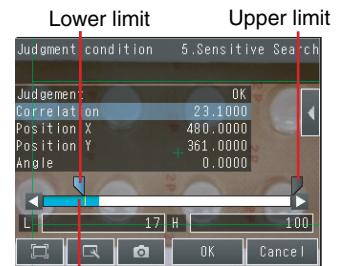

Blue for OK. Red for NG.

Parameter	Setting	Description
Correlation	Range: 0 to 100 Default: Lower: 60, Upper: 100	Set the correlation range that is to be judged as OK. If the correlation in the measurement results is 0, the judgment will be NG regardless of the setting of the lower limit.
Position X	Range: -99,999.9999 to 99,999.9999 Default: Lower: -99,999.9999 Upper: 99,999.9999	Set the range of movement in the X direction that is to be judged as OK.
Position Y	Range: -99,999.9999 to 99,999.9999 Default: Lower: -99,999.9999 Upper: 99,999.9999	Set the range of movement in the Y direction that is to be judged as OK.
Angle	Range: -180 to 180 Default: Lower: -180 Upper: 180	Set the angle range that is to be judged as OK.
Density deviation	Color image Range: 0 to 221 Default: Lower: 0 Upper: 221 Monochrome image Range: 0 to 127 Default: Lower: 0 Upper: 127	Set the density difference range that is to be judged as OK. The value will increase for larger percentages of areas with no pattern. This parameter is valid when setting a plain inspection area for a divided model.

Note

- You can change the output form for each measurement value to one of the following settings.
Press [**◀**] – [Result type] on the right of the display.
 - Absolute value (Default): The measured coordinates are output as absolute values.
 - Relative value: The difference from the reference value is output.

Reflect in Total Judgment

You can specify whether to reflect the judgment results of an inspection item in the overall judgment. The Default is to reflect them.

- **[Inspect] – [Inspection] – [Add item.] – [Sensitive Search] – [Details] Tab Page – [Output parameter]**

Increasing Measurement Position Accuracy

You can increase the accuracy of measurement positioning.
You can calculate down to four decimal places.

- ▶ **[Inspect] – [Inspection] – [Sensitive Search] – [Modify] – [Details] Tab Page – [Meas. Parameter]**

- 1 Press **[Sub-pixel]** and select **[Yes]**.

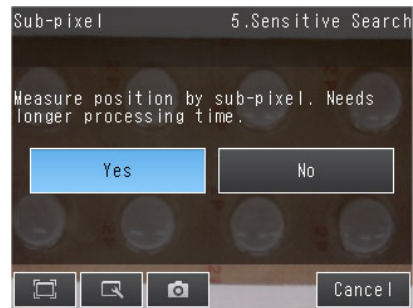

Select the Results to Output

Only objects with a correlation that is higher than the specified candidate level are output.

- ▶ **[Inspect] – [Inspection] – [Sensitive Search] – [Modify] – [Details] Tab Page – [Meas. Parameter]**

- 1 Press **[Candidate level]** and adjust the candidate level so that only objects higher than a certain correlation are detected.



Extraction condition	Range	Description
Candidate level	0 to 100 (Default: 70)	Set the threshold to find Candidate. Output the correlating value that is higher than [Candidate level] value. Decrease the value when Model search is unstable.

Note

The processing time changes if you change the candidate level.

Changing the Number Region Divisions

You can change the number of divisions of the registered model.

- **[Inspect] – [Inspection] – [Sensitive Search] – [Modify] – [Details] Tab Page – [Model parameter] – [Sub-model number]**

Parameter	Setting	Description
Sub-model number	<ul style="list-style-type: none">• 3×3• 5×5 (Default)• 9×9	Sets the number of divisions of the registered model.

Inspecting Plain Regions

Density deviations are used to inspect sections that are set as plain regions during teaching.

- **[Inspect] – [Inspection] – [Sensitive Search] – [Modify] – [Details] Tab Page – [Model parameter] – [Plain inspection]**

Parameter	Setting	Description
Plain inspection	<ul style="list-style-type: none">• Yes• No (Default)	Enables or disables inspecting plain sections.

Unstable Search Results

Inclined Measurement Objects

Adjust the [Angle range] parameter to increase the range in which a search is made for the model.

The Search inspection item judges whether an image is OK or NG according to the correlation with a previously registered image pattern.

For this reason, if the object is at an angle, the correlation is reduced and the image may be judged as NG.

To achieve an OK judgment for the same image pattern even when the object is at an angle, the rotation range must be widened.

► [Inspect] – [Inspection] – [Sensitive Search] – [Modify] – [Details] Tab Page – [Model parameter]

1 Set [Rotation] to [Yes].

2 Press [Angle range] and set the following range.

Parameter	Setting	Description
Angle range	Range: -180 to 180 Default: Lower: -180 Upper: 180	A search is performed within the set angle range. The larger the angle range, the longer the processing time. Important If you change the angle range, perform teaching again.  p. 261

Correlation Is Inconsistent Due to Low Contrast

Adjust the brightness to improve the contrast of the mark.

 *Adjusting the Brightness: p. 77*

Correlation Is Inconsistent Due to Variations in the Measurement Object

Inconsistent portions can be masked so that they are omitted from matching.

 *Model masking: p. 226*

Increasing Processing Speed

The following two methods can be used to reduce processing time.

- **Reduce the range in which a search is performed for the model.**

 *Changing the measurement region: p. 227*

- **Reduce the angle range setting.**

Adjust the [Angle range] parameter to reduce the range in which a search for the model is performed.

 *Setting the angle range: p. 266*

For more accurate detection, consider the followings:

- Set [Model mode] to [Stable]
- Raise [Candidate level].

For [Candidate level], refer to  *Select the Results to Output: p. 221*

Editing the Model Regions and Measurement Region

Changing the Model Regions

This section describes how to edit the model regions. You can edit the model region in the same way as for a search region.

Changing the Model Registration Region to a Shape Other Than a Rectangle:  p. 225

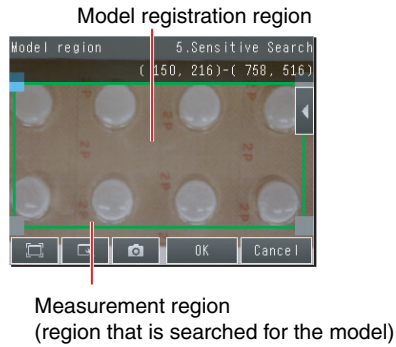

Important

If the model region is changed, perform teaching again.  p. 261

Changing the Measurement Region

The region within which the model is searched can be changed. You can edit the measurement region in the same way as for a search region.

Changing the Measurement Region:  p. 227

Measurement Data That Can Be Used for External Outputs and Calculations

The following values can be used as measurement data and output to external devices via the Ethernet or used in calculations.

Expression text string	Data name	Description	Data range
JG	Judgement	This is the judgment result of the sensitive search.	-2: No judgment (not measured) 0: Judgment is OK -1: Judgment is NG -13: Teaching not performed error -14: Figure not registered error -15: Out of range error
CR	Correlation	Correlation	0 to 100
DV	Deviation	Density deviation	Color image: 0 to 221 Monochrome image: 0 to 127
X	Position X	This is the X coordinate of the position where the model was found.	-999,999,999.9999 to 999,999,999.9999
Y	Position Y	This is the Y coordinate of the position where the model was found.	-999,999,999.9999 to 999,999,999.9999
TH	Angle	This is the angle of the position where the model was found.	-180 to 180
RX	Detection X	This is the X coordinate of the detection point when the model was registered.	-999,999,999.9999 to 999,999,999.9999
RY	Detection Y	This is the Y coordinate of the detection point when the model was registered.	-999,999,999.9999 to 999,999,999.9999
SX	Reference position X	This is the X coordinate of the position where the model was registered. (This is the center of the model region.)	-999,999,999.9999 to 999,999,999.9999
SY	Reference position Y	This is the Y coordinate of the position where the model was registered. (This is the center of the model region.)	-999,999,999.9999 to 999,999,999.9999
ST	Reference angle	This is the angle when the model was registered.	-180 to 180
CT	NG sub-region	This is the number of NG sub-regions.	0 to 100
AN	Sub-region number	This is the number of the regions with the lowest correlation.	0 to 99
ANX	Sub-region number (X)	This is the column number in the X direction of the output region.	0
ANY	Sub-region number (Y)	This is the row number in the Y direction of the output region.	0
DX	Sub-region pos. X	This is the X coordinate of the sub-region that was found.	-999,999,999.9999 to 999,999,999.9999
DY	Sub-region pos. Y	This is the Y coordinate of the sub-region that was found.	-999,999,999.9999 to 999,999,999.9999
CRN[0] to CRN[99]	Correlation (sub-region)	This is the correlation of the sub-region that was found.	0 to 100
DVN[0] to DVN[99]	Deviation (sub-region)	This is the density deviation of the region that was found.	Color image: 0 to 221 Monochrome image: 0 to 127

 4-18 Calculations and Judgments Using Inspection Item Data: p. 323

Measurement Data That Can Be Logged

The following values can be logged as measurement data.

Parameter	Range of value	Description
Judgement	-2: No judgment (not measured) 0: Judgment is OK -1: Judgment is NG	This is the judgment result of the sensitive search.
Correlation	0 to 100	Correlation
D deviation	Color image: 0 to 221 Monochrome image: 0 to 127	Density deviation
Position X	-99,999.9999 to 99,999.9999	This is the X coordinate of the position where the model was found.
Position Y	-99,999.9999 to 99,999.9999	This is the Y coordinate of the position where the model was found.
Angle	-180 to 180	This is the angle of the position where the model was found.
NG sub-region	0 to 100	This is the number of NG sub-regions.
Sub-region number	0 to 99	This is the number of the regions with the lowest correlation.
Sub-region pos. X (sub-region number (X))	0 to 9	This is the column number in the X direction of the output region.
Sub-region pos. Y (sub-region number (Y))	0 to 9	This is the row number in the Y direction of the output region.
Sub-region position X	-999,999,999.9999 to 999,999,999.9999	This is the X coordinate of the sub-region that was found.
Sub-region position Y	-999,999,999.9999 to 999,999,999.9999	This is the Y coordinate of the sub-region that was found.
Correlation (sub-region)	0 to 100	Correlation
Deviation (sub-region)	Color image: 0 to 221 Monochrome image: 0 to 127	Density deviation

* When logging data is output, the data is output in the order of the above table.

 7-6 Logging Measurement Data and Image Data: p. 392

Errors

Errors in Teaching

A teaching error message will appear if the contrast of the image within the model registration region is too low. Select a region with a larger contrast between light and dark areas compared to the region that was registered as the model and re-register it as the model.

4-12 Inspecting with the Edge Position Inspection Item

FQ2-S1

FQ2-S2

FQ2-S3

FQ2-S4

Edge Position

This inspection item is used to inspect positions. For example, it can be used to see if a label is attached at the correct position or if a product is set in the correct position.

Places where the color changes greatly are called edges. The positions of these edges are measured.

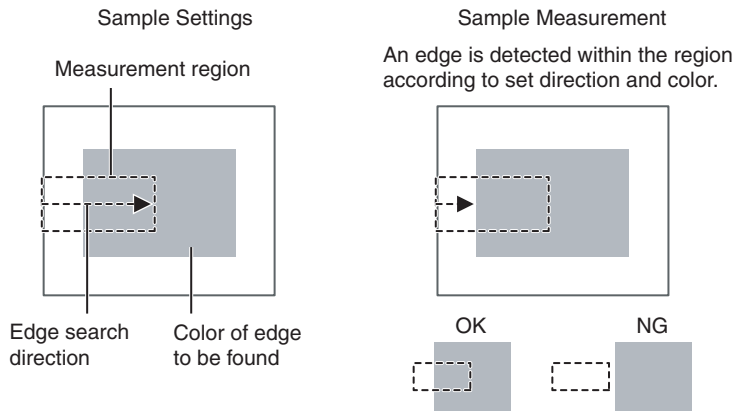

Setup Procedure for Edge Position

Step 1 Selecting the Inspection Item

▶ [Inspect] – [Inspection]

1 Press an unused inspection item number and press [Add item.].

2 Press [Edge position].

 *Registering inspection items: p. 138*

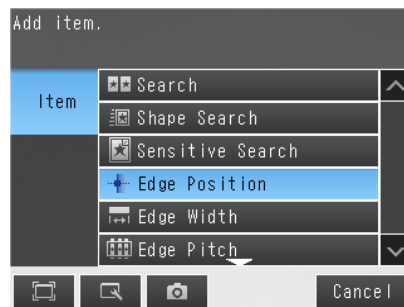

Note

Drag the arrow  at the bottom of the menu upward to display all of the inspection items.

Step 2 Teaching

Teaching means to store the region and the edge position in the region as reference data for the measurement.

► [Inspect] – [Inspection] – [Add item.] – [Edge Position] – [Settings] Tab Page

1 Press [Teach].

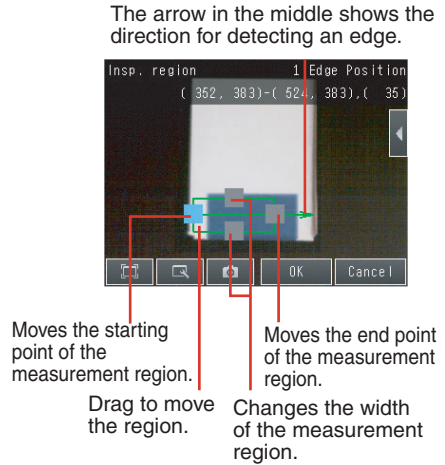

2 Place the object that is to be used as the measurement reference in front of the camera.

3 Move the rectangle to the location to be measured.

4 Press [OK].

5 Press [TEACH] on the lower right of the display.

The basic settings will be registered when teaching has been completed.

6 Press [Back] to end teaching.

📖 *Changing the measurement region: p. 227*

The following data is stored as basic measurement data.

Item	Parameter	Description
Reference data	Reference position X	The reference coordinates (X, Y) of the position are set automatically.
	Reference position Y	

Step 3 Adjusting Judgment Parameters

► [Inspect] – [Inspection] – [Add item.] – [Edge Position] – [Settings] Tab Page

1 Press [Judgement].

2 Press the parameters and set the range that is to be judged as OK.

The measurement value is displayed next to the parameter name. Continuous measurements will be performed for the images that are displayed.

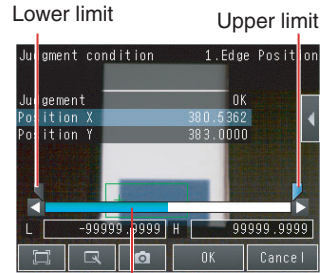

Blue for OK. Red for NG.

Note

You can change the parameters for judgement conditions on the Display Settings Display. Press [◀] – [Display setting] on the right of the display to switch to the Display Settings Display.

3 Press [OK] to enter the value.

Parameter	Setting	Description
Offset amount	Range: -99,999.9999 to 99,999.9999 Defaults: Lower: -1,640 Upper: 1,640	Sets the upper/lower limit range for the amount of position deviation considered to be OK.
Position X	Range: -99,999.9999 to 99,999.9999 Defaults: Lower: -99,999.9999 Upper: 99,999.9999	Sets the upper/lower limit range for the amount of edge position X considered to be OK.
Position Y	Range: -99,999.9999 to 99,999.9999 Defaults: Lower: -99,999.9999 Upper: 99,999.9999	Sets the upper/lower limit range for the amount of edge position Y considered to be OK.

Note

- You can change the output form for each measurement value to one of the following settings. Press [◀] – [Result type] on the right of the display.
 - Absolute value (Default): The measured coordinates are output as absolute values.
 - Relative value: The difference from the reference value is output.

Reflect in Total Judgment

You can specify whether to reflect the judgment results of an inspection item in the overall judgment. The Default is to reflect them.

- ▶ **[Inspect] – [Inspection] – [Add item.] – [Edge Position] – [Details] Tab Page – [Output parameter]**

Changing Edge Detection Conditions (Sensors with Monochrome Cameras Only)

You can change the following measurement conditions for Sensors with Monochrome Cameras.

- ▶ **[Inspect] – [Inspection] – [Edge Position] – [Modify] – [Details] Tab Page – [Meas. Parameter]**

Item	Parameter	Description
Measurement methods	Projection	A projection is formed based on the gray level, and any position of intersection between the gray level value and the threshold (edge level) is detected as an edge. This detection method is used when you must process an image with excessive noise or when the edges are blurry.
	Differentiation	A differentiated waveform is created that represents the amount of change in gray level between neighboring pixels. The maximum value of the differentiated waveform that exceeds the threshold (edge level) is detected as an edge. This detection method is used for low-contrast images.
Density change (when Measurement methods is set to Projection only)	Light to Dark	Detects as an edge any position within the specified region that changes from white to black.
	Dark to Light	Detects as an edge any position within the specified region that changes from black to white.

Unstable Edge Position Results

There Is an Edge But It Cannot Be Detected

► [Inspect] – [Inspection] – [Edge Position] – [Modify] – [Details] Tab Page – [Meas. Parameter] – [Edge Level]

Parameter	Setting	Description
Edge level	Color diff. / density diff. (%) Range: 0 to 100 Default: 50 When specified by absolute value • Color Range: 0 to 442 Default: 20 • Monochrome Range: 0 to 255 Default: 20	Set the color change level to detect as an edge. The edge point is found based on a threshold that is set for a color change. Important If you change the edge level, perform teaching again.

Note

Edge Level

- When measuring by relative value (%) of color difference width
An edge is detected in the following way.

1. The color change distribution of the entire measurement region is determined.
2. The minimum color change is 0%. The maximum color change is 100%.
3. The location where the color change intersects with the edge level is detected as the edge.

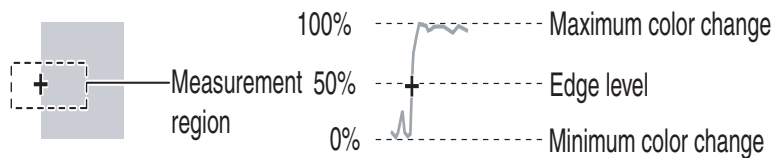

- When measuring by color difference value
The edge threshold is set using the absolute value of the color difference.

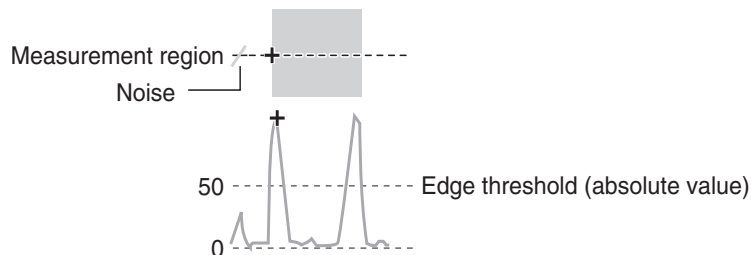

Noise Is Mistaken as an Edge

- [Inspect] – [Inspection] – [Edge Position] – [Modify] – [Details] Tab Page – [Meas. Parameter] – [Noise Level]

Parameter	Setting	Description
Noise level	Sensors with Color Cameras Only Range: 0 to 442 Default: 5 (Sensors with Monochrome Cameras only) Range: 0 to 255 Default: 5	Sets the density level to be considered as noise. If the difference between the maximum and minimum color changes in the region is below the noise level, it will be assumed that there is no edge. Increase this value if noise is incorrectly detected as an edge. Important If you change the noise level, perform teaching again.

Note

Noise threshold

The maximum and minimum color deviations and densities within the edge detection region are determined. If the difference is less than the noise threshold, it is assumed that there are no edges. Normally there is no problem with the Default value of 10, but if noise is mistakenly detected as an edge, make this value higher.

- Sensors with Color Camera

Within the Region

Max. color change – Min. color change < Noise threshold → No edge found → Measurement result: NG

Max. color change – Min. color change ≥ Noise threshold → Edge found → Perform measurement

- Sensors with Monochrome Cameras

Max. density change – Min. density change < Noise threshold → No edge found → Measurement result: NG

Max. density change – Min. density change – Noise threshold → Edge found → Perform measurement

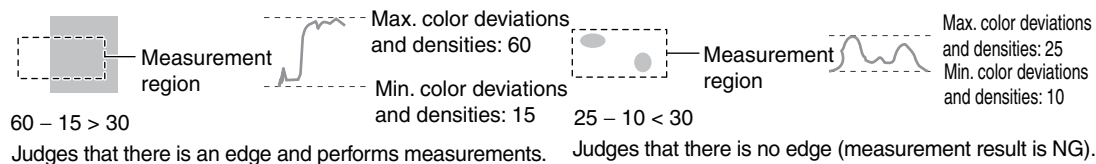

Screen Display When the Edge Level and Noise Level Are Changing

A bar showing the threshold level moves up and down on the graphic as the edge level/noise level value changes. A cross-key cursor will also appear at the detected edge position.

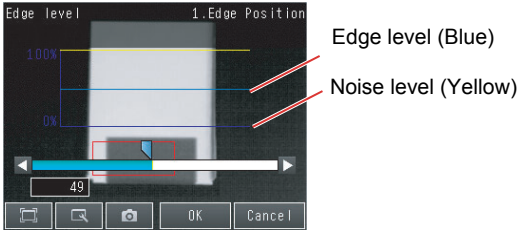

Screen display when the edge level are changing.

Undesired Edge Position Is Automatically Detected When Teaching (Sensors with Color Cameras Only)

Manually set the color of the edge that you want to detect.

► [Inspect] – [Inspection] – [Edge Position] – [Modify] – [Settings] Tab Page – [Teach]

- 1 Press [◀] – [Color ON/OFF] on the right side of the display.
- 2 Press [ON].
- 3 Press [◀] – [Set color.] on the right of the display.
- 4 Press [◀] – [Detection mode] on the right of the display and select one of the following detection modes.
- 5 Draw a rectangle around the color that you want to use to extract an edge.

The specified color will be extracted.
- 6 Press [OK] to enter the edge color.
- 7 Press [TEACH] again.
- 8 Press [Back].

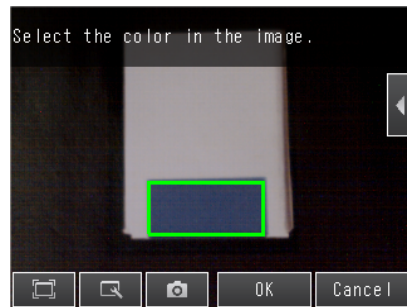

(Only a rectangle can be used to specify the region.)

Item	Parameter	Description
Detection mode	Color IN	Detects as an edge any position where the color changes from another color to the specified color.
	Color OUT	Detects as an edge any position where the color changes from the specified color to another color.

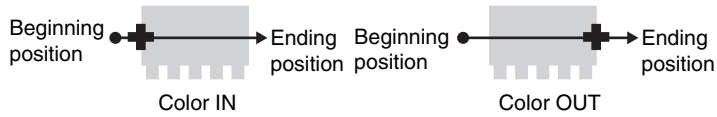

Note

It is also possible to check the extraction colors or specify them using the color palette. The RGB values of the extraction color can be checked and adjusted using the color palette.

If you press [◀] – [Color palette], a color palette will appear.

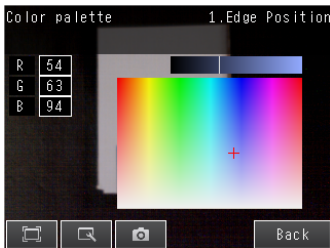

When a color is pressed on the color palette, its RGB values will be displayed.

Increasing Processing Speed for Edge Position

Make the measurement region smaller to reduce the processing time.

 *Changing the measurement region: p. 227*

Measurement Data That Can Be Used for External Outputs and Calculations

The following values can be used as measurement data and output to external devices via the Ethernet or used in calculations.

Expression text string	Data name	Description	Data range
JG	Judgement	-2: No judgement (not measured) 0: Judgement is OK -1: Judgement is NG -13: Teaching not performed error -14: Figure not registered error -15: Out of range error	This is the judgment result.
X	Position X	-99999.9999 to 99999.9999	This is the X coordinate of the measured edge position.
Y	Position Y	-99999.9999 to 99999.9999	This is the Y coordinate of the measured edge position.
SX	Ref. position X (reference position X)	-99999.9999 to 99999.9999	This is the X coordinate of the edge position when a range is set.
SY	Ref. position Y (reference position Y)	-99999.9999 to 99999.9999	This is the Y coordinate of the edge position when a range is set.
DF	D. position (difference in position)	-99999.9999 to 99999.9999	This is the offset from the measured reference position.

 4-18 Calculations and Judgments Using Inspection Item Data: p. 323

Measurement Data That Can Be Logged for Edge Position

The following values can be logged as measurement data.

Measured item	Range of value	Description
Judgement	0: Judgement is OK -1: Judgement is NG -13: Teaching not performed error -14: Figure not registered error -15: Out of range error	This is the measurement judgment results.
D. position (difference in position)	-99999.9999 to 99999.9999	This is the offset from the measured reference position.
Position X	-99999.9999 to 99999.9999	This is the X coordinate of the measured edge position.
Position Y	-99999.9999 to 99999.9999	This is the Y coordinate of the measured edge position.

* When logging data is output, the data is output in the order of the above table.
If more than one item is stored, results are output for each model.

 7-6 Logging Measurement Data and Image Data: p. 392

Errors

Errors in Teaching

A teaching error message will appear if the edge position cannot be detected when teaching. Perform the following.

- If the color of the measurement object has changed from the specified color, set the color again and try teaching again.
- If there is an edge and it cannot be detected, adjust the [Noise level] on the [Details] Tab Page and try teaching again.

Edge Not Found

If an edge is not found, the measurement result will be NG. Perform the following.

- If a color was specified, make sure the color of the measurement object has not changed from the specified color.
- Set the color again if necessary.
- If there is an edge and it cannot be detected, make sure the [Edge level] parameter on the [Details] Tab Page is correct.

 Edge level: p. 276

4-13 Inspecting with the Edge Width Inspection Item

FQ2-S1

FQ2-S2

FQ2-S3

FQ2-S4

Edge Width Inspection Item

This inspection item is used to measure dimensions. Places where the color changes greatly are called edges. The distance between two edges is called the edge width.

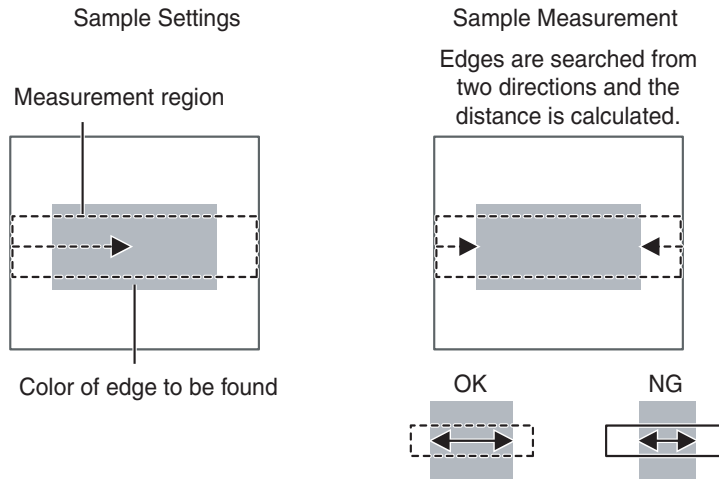

Setup Procedure for Edge Width Inspection Item

Step 1 Selecting the Inspection Item

► [Inspect] – [Inspection]

1 Press an unused inspection item number and press [Add item.].

2 Press [Edge Width].

 *Registering inspection items: p. 138*

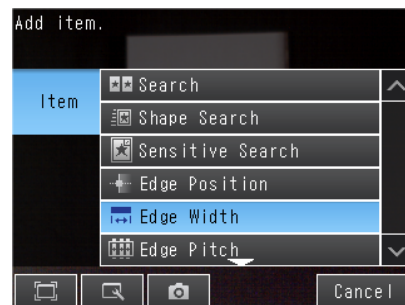

Note

Drag the arrow  at the bottom of the menu upward to display all of the inspection items.

Step 2 Teaching

Teaching means to store the region and the edge width in the region as reference data for the measurement.

► [Inspect] – [Inspection] – [Add item.] – [Edge Width] – [Settings] Tab Page

1 Press [Teach].

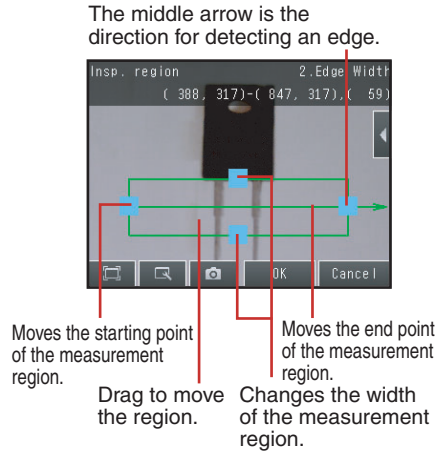

2 Place the object that is to be used as the measurement reference in front of the camera.

3 Move the rectangle to the location to be measured.

4 Press [OK].

5 Press [TEACH] on the lower right of the display.

The basic settings will be registered when teaching has been completed.

6 Press [Back] to end teaching.

📖 *Changing the measurement region: p. 227*

The following data is stored as the measurement reference.

Item	Parameter	Description
Reference data	Reference width	The reference edge width is set automatically.

Step 3 Adjusting the Judgement Parameters

► [Inspect] – [Inspection] – [Add item.] – [Edge Width] – [Settings] Tab Page

1 Press [Judgement].

2 Set the D. Width range for an OK judgement.

Continuous measurements will be performed for the images that are displayed. The measured value is displayed beside the parameter name.

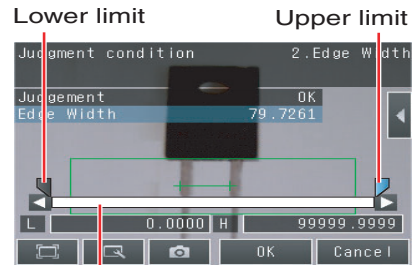

Blue for OK. Red for NG.

Note

You can change the parameters for judgement conditions on the Display Settings Display. Press [◀] – [Display setting] on the right of the display to switch to the Display Settings Display.

3 Press [OK] to enter the value.

Parameter	Setting	Description
Edge width (edge in width)	When the result type is set to absolute value Range: 0.0000 to 99,999.999 Defaults: Upper: 99,999.999 Lower: 0.0000	Set the upper and lower limits of the reference width for an OK judgment.
	When the result type is set to relative values: Range: -99,999.9999 or 99,999.999 Defaults: Upper: 99,999.9999 Lower: -99,999.9999	
	When the result type is set to ratios: Range: 0.000 to 999.9999(%) Defaults: Upper: 999.9999 Lower: 0.000	

Note

- You can change the output form for each measurement value to one of the following settings. Press [◀] – [Result type] on the right of the display.
 - Absolute value (Default): The measured edge width is output.
 - Relative value: The difference from the reference value is output.
 - Ratio: The percentage of the reference value is output.

Changing Edge Detection Conditions (Sensors with Monochrome Cameras Only)

You can change the measurement conditions for Sensors with Monochrome Cameras. Change the [Density change] and [Measurement method] parameters.

 p. 275

Reflect in Total Judgment

You can specify whether to reflect the judgment results of an inspection item in the overall judgment. The Default is to reflect them.

▶ **[Inspect] – [Inspection] – [Add item.] – [Edge Width] – [Details] Tab Page – [Output parameter]**

Unstable Edge Width Results (Sensors with Color Cameras)

If the measurement result is not stable, adjust the [Edge level], [Noise level], and [Set color.] parameters.

 p. 276

Increasing Edge Width Processing Speed

Make the measurement region smaller to reduce the processing time.

 Changing the measurement region: p. 227

Measurement Data That Can Be Used for External Outputs and Calculations

The following values can be output to external devices or used in calculations as measurement data.

Expression text string	Data name	Description	Data range
JG	Judgement	-2: No judgement (not measured) 0: Judgement is OK -1: Judgement is NG -13: Teaching not performed error -14: Figure not registered error -15: Out of range error	This is the judgment result.
W	Edge width	0 to 99999.9999	Edge width
SW	Ref. edge width (reference edge width)	0 to 99999.9999	This is the reference edge width from when the model was registered.
DF	D. edge width (difference in edge width)	0 to 99999.9999	This is the difference between the reference edge width and the measured edge width.

 4-18 Calculations and Judgments Using Inspection Item Data: p. 323

Measurement Data That Can Be Logged for Edge Width

The following values can be logged as measurement data.

Measured item	Range of value	Description
Judgement	0: Judgement is OK, -1: Judgement is NG, -13: Teaching not performed error -14: Figure not registered error -15: Out of range error	This is the measurement judgment results.
Edge Width (edge in width)	-99999.9999 to 99999.9999	This is the difference between the reference width and the measured edge width.

*1 When logging data is output, the data is output in the order of the above table.
If more than one item is stored, results are output for each model.

 7-6 Logging Measurement Data and Image Data: p. 392

Errors

Errors in Teaching

A teaching error message will appear if the edge position cannot be detected when teaching. Perform the following.

- If the color of the measurement object has changed from the specified color, set the color again and try teaching again.
- If there is an edge and it cannot be detected, adjust the [Noise level] on the [Details] Tab Page and try teaching again.

If an edge is not detected when teaching, 0 will be registered as the reference width.

Edge Not Found

The measured edge width will be 0. Perform the following:

- If a color was specified, make sure the color of the measurement object has not changed from the specified color.
- Set the color again if necessary.
- If there is an edge and it cannot be detected, make sure the [Edge level] parameter on the [Details] Tab Page is correct.

 *Edge level: p. 276*

4-14 Inspecting with the Edge Pitch Inspection Item

FQ2-S1

FQ2-S2

FQ2-S3

FQ2-S4

Edge Pitch Inspection Item

This inspection item is used to detect edges through changes in brightness within a region.

Edges of the specified color in one measurement area are found and the number objects, object width, and pitch are output.

Sample Settings

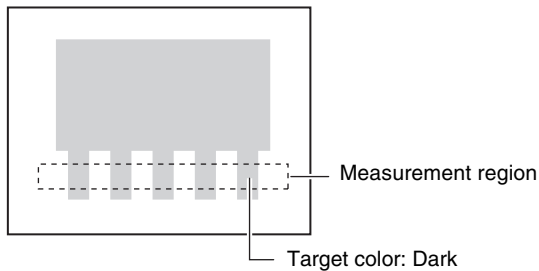

Sample Measurement

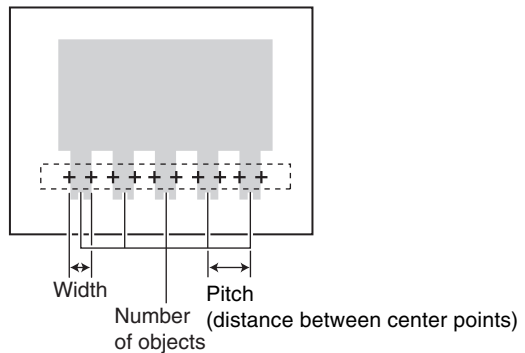

Setup Procedure for Edge Width Inspection Item

Step 1 Selecting the Inspection Item

► [Inspect] – [Inspection]

1 Press an unused inspection item number and press [Add item.].

2 Press [Edge Pitch].

📖 *Registering inspection items: p. 138*



Note

Drag the arrow  at the bottom of the menu upward to display all of the inspection items.

Step 2 Teaching

Teaching means to store the region as reference data for the measurement.

► [Inspect] – [Inspection] – [Add item.] – [Edge Pitch] – [Settings] Tab Page

- 1 Press [Teach].
- 2 Place the object that is to be used as the measurement reference in front of the camera.
- 3 Move the rectangle to the location to be measured.
- 4 Press [OK].

The middle arrow is the direction for detecting an edge.

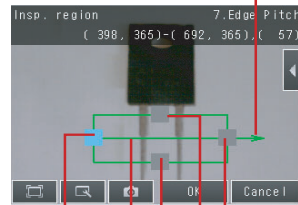

Moves the starting point of the measurement region.

Drag to move the region.

Moves the end point of the measurement region.

Changes the width of the measurement region.

□ Changing the Measurement Region: p. 227

Step 3 Adjusting the Judgment Parameters

► [Inspect] – [Inspection] – [Add item.] – [Edge Pitch] – [Settings] Tab Page

- 1 Press [Judgement].
- 2 Press the parameters and set the range that is to be judged as OK.

Continuous measurements will be performed for the images that are displayed. The measured value is displayed beside the parameter name.

Note

You can change the parameters for judgment conditions on the Display Settings Display.

Press [◀] – [Display setting] on the right of the display to switch to the Display Settings Display.

- 3 Press [OK] to enter the value.

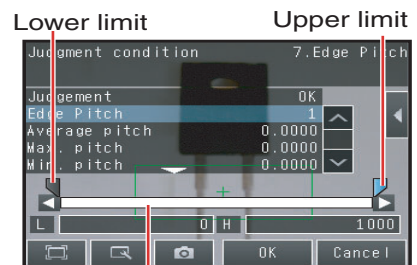

Blue for OK. Red for NG.

Item	Parameter	Setting	Description
Judgment Parameter	Edge pitch	Range : 0 to 1000 Defaults: Lower: 0 Upper: 1000	Set the range that is to be judged OK for each parameter. Edge pitch (number of objects)
	Average pitch	Range : 0.0000 to 99,999.9999 Defaults: Lower: 0.0000 Upper: 99,999.9999	
	Max. pitch (maximum pitch)	Range : 0.0000 to 99,999.9999 Defaults: Lower: 0.0000 Upper: 99,999.9999	
	Min. pitch (minimum pitch)	Range : 0.0000 to 99,999.9999 Defaults: Lower: 0.0000 Upper: 99,999.9999	
	Average width	Range : 0.0000 to 99,999.9999 Defaults: Lower: 0.0000 Upper: 99,999.9999	
	Max. width (maximum pitch)	Range : 0.0000 to 99,999.9999 Defaults: Lower: 0.0000 Upper: 99,999.9999	
	Min. width (minimum pitch)	Range : 0.0000 to 99,999.9999 Defaults: Lower: 0.0000 Upper: 99,999.9999	

Changing Edge Detection Conditions (Sensors with Monochrome Cameras Only)

You can change the following measurement conditions for Sensors with Monochrome Cameras.

► **[Inspect] – [Inspection] – [Edge Pitch] – [Modify] – [Details] Tab Page – [Meas.parameter]**

Parameter	Setting	Description
Color to count	• White (Default) • Black	Sets the color of edges to measure.
Mode	• Standard (Default) • Precise	Select the Precise Mode if the pin width or pitch is less than 2 pixels.

Reflect in Total Judgment

You can specify whether to reflect the judgment results of an inspection item in the overall judgment. The Default is to reflect them.

► **[Inspect] – [Inspection] – [Add item.] – [Edge Pitch] – [Details] Tab Page – [Output parameter]**

Unstable Edge Pitch Results (Sensors with Color Cameras Only)

If the measurement result is not stable, adjust the [Edge level], [Noise level], and [Set color.] parameters.

 p. 276

Increasing Edge Pitch Processing Speed

Make the measurement region smaller to reduce the processing time.

 *Changing the measurement region: p. 227*

Measurement Data That Can Be Used for External Outputs and Calculations

The following values can be output to external devices or used in calculations as measurement data.

Expression text string	Data name	Description	Data range
JG	Judgement	-2: No judgement (not measured) 0: Judgement is OK -1: Judgement is NG -13: Teaching not performed error -14: Figure not registered error -15: Out of range error	This is the judgement result.
N	Edge pitch	0 to 999	This is the number of objects.
P	Average pitch	0 to 99999.9999	This is the average pitch.
PH	Max. pitch	0 to 99999.9999	This is the maximum pitch.
PL	Min. pitch	0 to 99999.9999	This is the minimum pitch.
W	Average width	0 to 99999.9999	This is the average width between edges.
WH	Max. width	0 to 99999.9999	This is the maximum width between edges.
WL	Min. width	0 to 99999.9999	This is the minimum width between edges.

 *4-18 Calculations and Judgments Using Inspection Item Data: p. 323*

Measurement Data That Can Be Logged for Edge Pitch

The following values can be logged as measurement data.

Measured item	Range of value	Description
Judgement	-2: No judgement (not measured) 0: Judgement is OK -1: Judgement is NG -13: Teaching not performed error -14: Figure not registered error -15: Out of range error	This is the judgement result from the measurements.
Edge pitch	0 to 999	This is the number of objects that were detected.
Average pitch	0 to 99999.9999	This is the average pitch that was detected.
Max. pitch	0 to 99999.9999	This is the maximum pitch that was detected.
Min. pitch	0 to 99999.9999	This is the minimum pitch that was detected.
Average width	0 to 99999.9999	This is the average width that was detected between edges.
Max. width	0 to 99999.9999	This is the maximum width that was detected between edges.
Min. width	0 to 99999.9999	This is the minimum width that was detected between edges.

* When logging data is output, the data is output in the order of the above table.

 7-6 Logging Measurement Data and Image Data: p. 392

Errors

Edge Not Found

The measured edge pitch will be 0. Perform the following.

- If a color was specified, make sure the color of the measurement object has not changed from the specified color.
- Set the color again if necessary.
- If there is an edge and it cannot be detected, make sure the [Edge level] parameter on the [Details] Tab Page is correct.

 Edge level: p. 276

4-15 Inspecting with Color Data Inspection Item

FQ2-S1

FQ2-S2

FQ2-S3

FQ2-S4

Color Data Inspection Item

This inspection item is used to perform inspections for foreign matter with a different color or for presence. The region is set for a portion of the image with the color that is to be measured. This region is called the measurement region. The average color within the measurement region is measured.

If a Sensor with a Monochrome Camera is connected, the average density in the measurement region is found and inspections are performed for the difference from the registered reference value (density average) and the variation within the measurement region (density deviation).

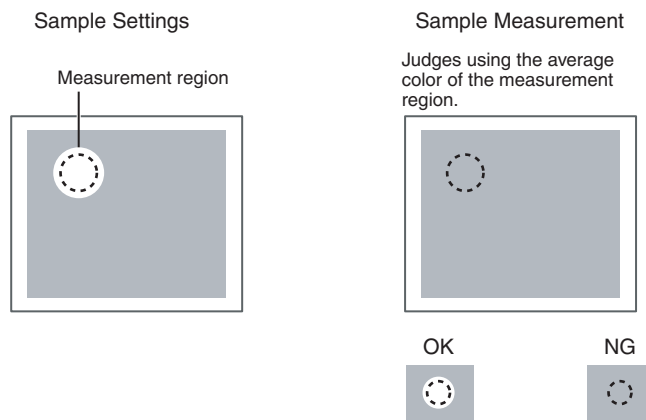

If a Sensor with a Monochrome Camera is connected, the average density in the measurement region is measured and the density deviation is used for judgments.

Setup Procedure for Color Data Inspection Item

Step 1 Selecting the Inspection Item

► [Inspect] – [Inspection]

1 Press an unused inspection item number and press [Add item.].

2 Press [Color Data].

 *Registering inspection items: p. 138*

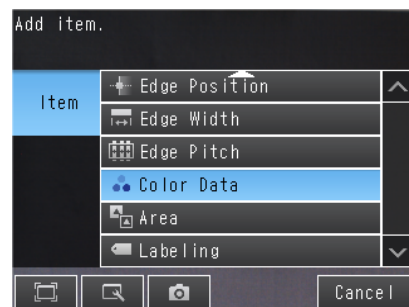

Note

Drag the arrow  at the bottom of the menu upward to display all of the inspection items.

Step 2 Teaching

Teaching means to store the region and the average color in the region as reference data for the measurement.

► [Inspect] – [Inspection] – [Add item.] – [Color Data] – [Settings] Tab Page

1 Press [Teach].

Drag the rectangle to move it.

Drag a corner to size the rectangle.



2 Place the object that is to be used as the measurement reference in front of the camera.

3 Move the rectangle to the location to be measured.

4 Press [OK].

5 Press [TEACH] on the lower right of the display.

The basic settings will be registered when teaching has been completed.

6 Press [Back] to end teaching.

 *Changing the measurement region: p. 227*

The following data is stored as the measurement reference.

Item	Parameter	Description
Reference data	Reference color R	The R average to use as a reference is set automatically.
	Reference color G	The G average to use as a reference is set automatically.
	Reference color B	The B average to use as a reference is set automatically.

Step 3 Adjusting Judgment Parameters

► [Inspect] – [Inspection] – [Add item.] – [Color Data] – [Settings] Tab Page

1 Press [Judgement].

2 Press the parameters and set the range that is to be judged as OK.

The measured value is displayed beside the parameter name. Continuous measurements will be performed for the images that are displayed.

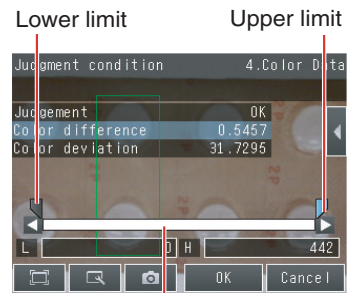

Blue for OK. Red for NG.

Note

You can change the parameters for judgment conditions on the Display Settings Display. Press [◀] – [Display setting] on the right of the display to switch to the Display Settings Display.

3 Press [OK] to enter the value.

• Sensors with Color Cameras Only

Item	Parameter	Setting	Description
Judgement Parameter	Color difference	0 to 442	Sets the upper and lower limits of the difference between the average color and reference color that is to be judged as OK.
	Color deviation	0 to 221	Set the upper and lower limits of the range of the deviation in the region that is to be judged as OK.
	R average	0.0000 to 255.0000	Set the difference in the average value of the R (red) component that is to be judged as OK.
	G average	0.0000 to 255.0000	Set the difference in the average value of the G (green) component that is to be judged as OK.
	B average	0.0000 to 255.0000	Set the difference in the average value of the B (blue) component that is to be judged as OK.

• Sensors with Monochrome Cameras only

Item	Parameter	Setting	Description
Judgement Parameter	Density average	0 to 255	Set the judgment upper and lower limits for the average density in the measurement region.
	Density deviat. (density deviation)	0 to 127	Set the upper and lower limits for the deviation in the average density in the measurement region.

Reflect in Total Judgment

You can specify whether to reflect the judgment results of an inspection item in the overall judgment.

► **[Inspect]** – **[Inspection]** – **[Add item.]** – **[Color Data]** – **[Details] Tab Page** – **[Output parameter]**

Measurement Data That Can Be Used for External Outputs and Calculations

The following values can be used as measurement data and output to external devices via the Ethernet or used in calculations.

Expression text string	Data name	Description	Data range
JG	Judgement	-2: No judgement (not measured) 0: Judgement is OK -1: Judgement is NG -10: Image error -13: Teaching not performed error -14: Figure not registered error -15: Out of range error -20: Other error	This is the judgment result.
AR	R average	0 to 255	This is the average value of the R (red) component.
AG	G average	0 to 255	This is the average value of the G (green) component.
AB	B average	0 to 255	This is the average value of the B (blue) component.
AD	Color diff./dens. AV. Color difference	0 to 442	(For Sensors with Color Cameras) This is the difference between the average color in the region and the standard color.
		0 to 255	(For Sensors with Monochrome Cameras) This is the difference between the average density in the region and the standard density.
DV	Clr. deviat. Color deviation	0 to 221	(For Sensors with Color Cameras) This is the deviation within the region.
		0 to 217	(For Sensors with Monochrome Cameras) This is the deviation within the region

 4-18 Calculations and Judgments Using Inspection Item Data: p. 323

Measurement Data That Can Be Logged (Color Data)

The following values can be logged as measurement data.

Measured item	Range of value	Description
Judgement	0: Judgement is OK, -1: Judgement is NG -10: Image error -13: Teaching not performed error -14: Figure not registered error -15: Out of range error -20: Other error	This is the measurement judgment results.
R average	0 to 255	This is the average value for the R (red) component.
G average	0 to 255	This is the average value for the G (green) component.
B average	0 to 255	This is the average value for the B (blue) component.
Color diff./dens. AV. Color (for Sensors with Color Cameras)	0 to 442	This is the difference between the color that was registered as the reference and the measured color. The average color within the measurement area is used in both cases.
Color diff./dens. AV. Color (for Sensors with Monochrome Cameras)	0 to 255	This is the difference between the average density in the region and the currently measured density.
Clr. deviat. (for Sensors with Color Cameras)	0 to 221	This is the deviation within the measurement region.
Clr. deviat. (for Sensors with Monochrome Cameras)	0 to 127	This is the deviation in the average density in the measurement region.

* When logging data is output, the data is output in the order of the above table.

 7-6 Logging Measurement Data and Image Data: p. 392

Increasing Processing Speed for Color Data

Make the measurement region smaller to reduce the processing time.

 Changing the measurement region: p. 227

4-16 Inspecting with the Area Inspection Item

FQ2-S1

FQ2-S2

FQ2-S3

FQ2-S4

Area Inspection Item

This inspection item is used to measure sizes. It measures the amount of a color within the measurement region. The size is calculated as a number of pixels and it is called the area.

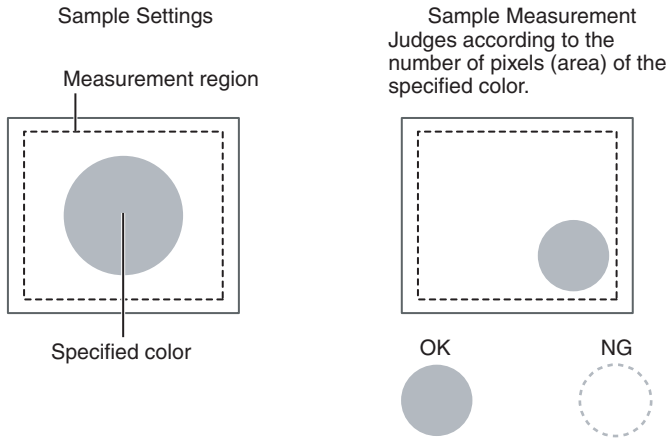

Setup Procedure for Area

Step 1 Selecting the Inspection Item

► [Inspect] – [Inspection]

1 Press an unused inspection item number and press [Add item.].

2 Press [Area].

📖 *Registering inspection items: p. 138*

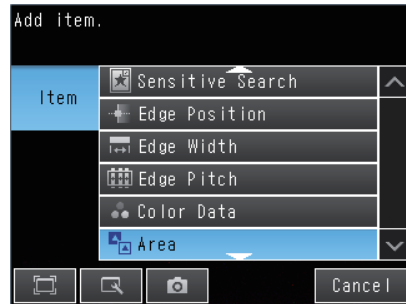

Note

Drag the arrow  at the bottom of the menu upward to display all of the inspection items.

Step 2 Teaching

Teaching means to store the region and the color area in the region as reference data for the measurement.

► [Inspect] – [Inspection] – [Add item.] – [Area] – [Settings] Tab Page

1 Press [Teach].

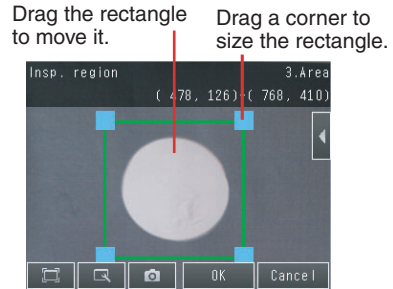

2 Place the object that is to be used as the measurement reference in front of the camera.

3 Move the rectangle to the location to be measured.

4 Press [OK].

5 Press [TEACH] on the lower right of the display.

The basic settings will be registered when teaching has been completed. Areas with the extracted color will be automatically detected.

Note

Information on the color that has the largest area in the measurement region is extracted and registered.

(The color information is extracted only the first time.)

The extracted color information will not change from the second time on.

To specify a desired color, refer to *Extraction Is Automatically Performed for an Undesired Color When Teaching* p. 305.

6 Press [Back] to end teaching.

 *Changing the measurement region: p. 227*

The following data is stored as the measurement reference.

Item	Parameter	Description
Reference data	Extract color	This is the color for which to measure the area. The color occupying the largest area will be automatically registered.  <i>Setting Colors Manually: p. 305</i>
	Reference area	The area to use as a reference is set automatically.

Step 3 Adjusting Judgment Parameters

► [Inspect] – [Inspection] – [Add item.] – [Area] – [Settings] Tab Page

1 Press [Judgement].

2 Press the parameters and set the range that is to be judged as OK.

The measured value is displayed beside the parameter name. Continuous measurements will be performed for the images that are displayed.

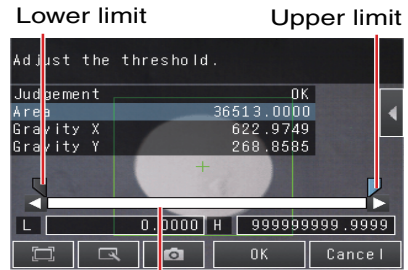

Blue for OK. Red for NG.

Note

You can change the parameters for judgment conditions on the Display Settings Display. Press [◀] – [Display setting] on the right of the display to switch to the Display Settings Display.

3 Press [OK] to enter the value.

Item	Parameter	Setting	Description
Judgement Parameter	Area	When the result type is set to absolute value Range: 0.0000 to 999,999,999.9999 Defaults: Upper: 999,999,999.9999 Lower: 0.0000	Set the upper and lower limits for an OK judgment. The set range is the difference between the reference area and the measured areas.
		When the result type is set to relative value Range: -999,999,999.9999 to 999,999,999.9999 Defaults: Upper: 999,999,999.9999 Lower: -999,999,999.9999	
		When the result type is set to ratio Range: 0.00000 to 999.9999 Defaults: Upper: 999.9999 Lower: 0.0000	
	Gravity X	Range: -99,999.9999 to 99,999.9999 Defaults: Upper: 99,999.9999 Lower: -99,999.9999	Set the upper and lower limits of the range of gravity X that is to be judged as OK.
	Gravity Y	Range: -99,999.9999 to 99,999.9999 Defaults: Upper: 99,999.9999 Lower: -99,999.9999	Set the upper and lower limits of the range of the gravity Y that is to be judged as OK.

Note

- You can change the output form for each measurement value to one of the following settings.
Press [◀] – [Result type] on the right of the display.
 - Absolute value (Default): The measured coordinates are output.
 - Relative value: The difference from the reference position is output as coordinates.
 - Ratio: The percentage of the reference value is output. (This applies to the area only.)

Reflect in Total Judgment

You can specify whether to reflect the judgment results of an inspection item in the overall judgment. (The Default is to reflect them.)

▶ [Inspect] – [Inspection] – [Add item.] – [Area] – [Details] Tab Page – [Output parameter]

Unstable Area Results

The Desired Color Cannot Be Detected

Add a specific color or enlarge the color range.

Extraction Is Automatically Performed for an Undesired Color When Teaching

Manually set the color for which to measure the area.

► [Inspect] – [Inspection] – [Area] – [Modify] – [Settings] Tab Page – [Teach]

• Sensors with Color Cameras Only

1 Press [◀] – [Set color] on the right of the display.

2 Drag around the color for which you want to measure the area.

Areas with that color will be automatically detected. Continuous measurements will be performed for the images that are displayed. Only the extracted color will appear on the display.

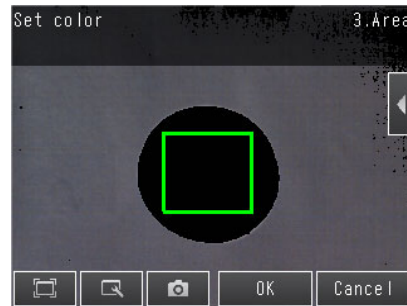

3 Press [OK].

4 Press [TEACH].

5 Press [Back] to end teaching.

Note

Measuring More Than One Color

Set the colors using the color palette.

Press [◀] – [Color palette] on the Set Color Display to display the color palette.

Up to four colors can be specified.

If the *Color inv.* Option is selected, the color outside the region will become the selected color.

If the *Inv.* Check Box is selected, the color outside the region will become the selected color.

The [Inv.] Check Box applies to all colors. Select the [Exclusion] Check Box to exclude the selected color from extraction. The order of exclusion is from the largest color palette number.

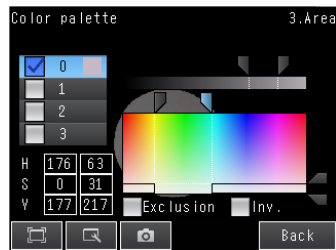

Making the Extract Color Easier to Check

- The display for the extracted color can be switched by using [◀] – [Display setting].
(The following display patterns can be selected for the extracted color: [Measurement image], [All color image] (Default), [Selected color image], or [Binary image].)
- Press [◀] – [Background color] to change the display for colors other than the extraction color.
(The color can be chosen from [Black] (Default), [White], [Red], [Green], or [Blue].)

• Sensors with Monochrome Cameras (or for a Color Gray Filter)

- 1 Press [◀] – [Set color] on the right of the display.
- 2 Press [◀] – [Binary level].
- 3 Specify the range of brightness to detect, and then press [OK].

Specify the range of brightness to convert to a binary image. Measurement is performed after the image taken by the camera in 256-color grayscale is converted to a binary image. Then, white pixels are measured.



- 4 Press [OK].
- 5 Press [TEACH].
- 6 Press [Back] to end teaching.

Note

Making the Extraction Results Easier to Check

- You can invert the black/white extraction results.
Press [◀] – [Reverse] and select [Yes].
- You can select whether to display a binary image.
Press [◀] – [Binary image display] and select [OFF] or [ON].

Changing the Area Detection Conditions

You can fill in the area detected through color extraction or binary conversion to perform a stable extraction of the areas and their characteristics or to mark only areas inside the measurement region for inspection.

► **[Inspect] – [Inspection] – [Aria] – [Modify] – [Details] Tab Page – [Meas. Parameter]**

- 1 Press **[Fill profile]** and select **[Filling up holes]** or **[Fill Outline]**.

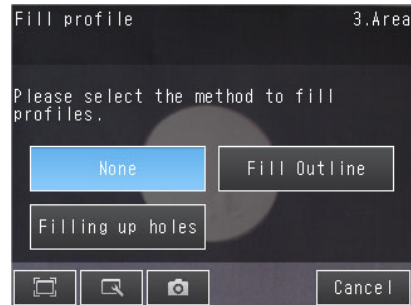

Parameter	Setting	Description
Fill profile	<ul style="list-style-type: none"> • None (Default) • Fill Outline • Filling up holes 	<p>None: Holes are not filled. Filling up holes: Processes areas that are surrounded by the specified color, like in the shape of a donut, as the specified color.</p> <div style="text-align: center;"> <p>Input Image Filled Image</p> </div> <p>Fill Outline: Measures the image between the first extracted point and the last extracted point in the X axis direction in the measurement area as the extracted color. Because filling is performed only in the X axis direction, this method is faster than filling up holes.</p> <div style="text-align: center;"> <p>Input Image Image Following Fill Outline</p> </div>

Increasing Processing Speed for Area

Make the measurement region smaller to reduce the processing time.

📖 *Changing the measurement region: p. 227*

Measurement Data That Can Be Used for External Outputs and Calculations

The following values can be used as measurement data and output to external devices via the Ethernet or used in calculations.

Expression text string	Data name	Description	Data range
JG	Judgement	-2: No judgement (not measured) 0: Judgement is OK -1: Judgement is NG -13: Teaching not performed error -14: Figure not registered error -15: Out of range error	This is the judgement result.
AR	Area	0 to 999999999.9999	This is the area in the measurement region with the specified color.
X	Gravity X	-99999.9999 to 99999.9999	This is the X coordinate of the center of the measurement area with the specified color.
Y	Gravity Y	-99999.9999 to 99999.9999	This is the Y coordinate of the center of the measurement area with the specified color.
SA	Reference area	0 to 999999999.9999	This is the area with the specific color to be measured when a range is set.
SX	Ref. point X (reference point X)	-99999.9999 to 99999.9999	This is the X coordinate of the center of gravity when a range is set.
SY	Ref. point Y (reference point Y)	-99999.9999 to 99999.9999	This is the Y coordinate of the center of gravity when a range is set.

 4-18 Calculations and Judgments Using Inspection Item Data: p. 323

Measurement Data That Can Be Logged for Area

The following values can be logged as measurement data.

Measured item	Range of value	Description
Judgement	0: Judgement is OK -1: Judgement is NG -13: Teaching not performed error -14: Figure not registered error -15: Out of range error	This is the measurement judgement results.
Area	0 to 99999.9999	This is the measured color area.
Gravity X	-99999.9999 to 99999.9999	This is the detected center of gravity X coordinate.
Gravity Y	-99999.9999 to 99999.9999	This is the detected center of gravity Y coordinate.

* When logging data is output, the data is output in the order of the above table.

 7-6 Logging Measurement Data and Image Data: p. 392

4-17 Inspecting with the Labeling Inspection Item

FQ2-S1

FQ2-S2

FQ2-S3

FQ2-S4

Labeling

One region of the color you want to measure is counted as a Label. You can sort these labels by position or size, and assign numbers to them. You can then output the total number of labels, and size and position of a desired label.

Sample Settings

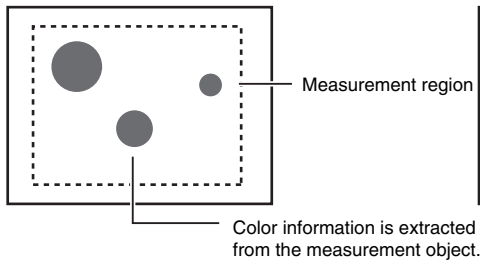

Sample Measurement

Regions of the extracted color are detected as labels.

Total number of detected labels: 3

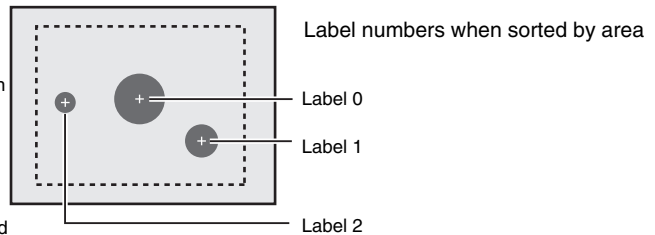

Note

If a Sensor with Color Camera is connected, you can specify up to four colors to measure.
If a Sensor with Monochrome Camera is connected, the image is converted to a black and white binary image. Then, white pixels are measured.

Setup Procedure for Labeling Inspection Item

Step 1 Selecting the Inspection Item

► [Inspect] – [Inspection]

1 Press an unused inspection item number and press [Add item.].

2 Press [Labeling].

 *Registering Inspection Items: p. 138*

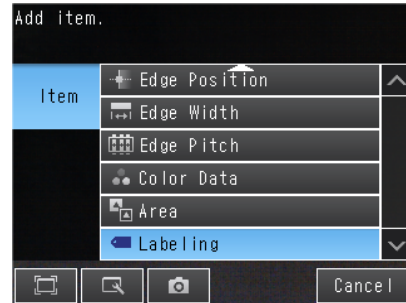

Note

Drag the arrow  at the bottom of the menu upward to display all of the inspection items.

Step 2 Teaching

Teaching means to register the region and label characteristics in that region as reference data for measurements.

- **Sensors with Color Cameras Only**

▶ **[Inspect] – [Inspection] – [Add item.] – [Labeling] – [Settings] Tab Page**

1 Press [Teach].

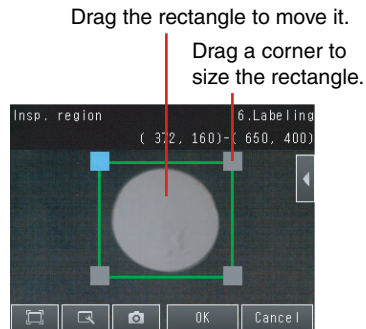

2 Place the object that is to be used as the measurement reference in front of the camera.

3 Move the rectangle to the location to be measured.

4 Press [OK].

5 Press [TEACH] on the lower right of the display.

The basic settings will be registered when teaching has been completed.

Note

Information on the color that has the largest area in the measurement region is extracted and registered. (The color information is extracted only the first time.)

The extracted color information will not change from the second time on.

To specify a desired color, refer to *Extraction Is Automatically Performed for an Undesired Color When Teaching*: p. 314.

6 Press [Back] to end teaching.

📖 *Changing the measurement region*: p. 227

Note

If you press the [TEACH] Button without specifying a color, the color with the largest area in the measurement region will be extracted and the resulting color information will be registered.

The following data is stored as the measurement reference.

Item	Parameter	Description
Reference data	Reference area	The area for label 0 to use as a reference is set automatically.
	Reference position X	The gravity position X for label 0 to use as a reference is set automatically.
	Reference position Y	The gravity position Y for label 0 to use as a reference is set automatically.

Step 3 Adjusting Judgment Parameters

► [Inspect] – [Inspection] – [Add item.] – [Labeling] – [Settings] Tab Page

1 Press [Judgement].

If more than one result was detected, you can switch to a display for each result.

2 Press the parameters and set the OK ranges.

Set the range for each of the following parameters. Continuous measurements will be performed for the images that are taken.

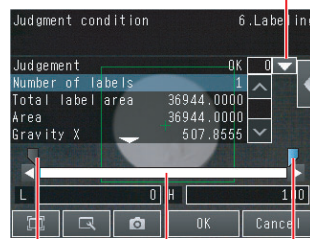

Upper limit Lower limit
Blue for OK. Red for NG.

Item	Parameter	Setting	Description
Judgment parameters	Number of labels	Range: 0 to 100 (Default)	Set the upper and lower limits of the number of labels for an OK judgment.
	Total label area	Range: 0 to 999,999,999.9999 (Default)	Set the upper and lower limits of the total label area for an OK judgment.
	Area	Range: 0 to 999,999,999.9999 (Default)	Sets the upper and lower limits of the area for an OK judgment.
	Gravity center X	Range: -99,999.999 to 99,999.999 (Default)	Set the upper and lower limits of the gravity X for an OK judgment.
	Gravity center Y	Range: -99,999.999 to 99,999.999 (Default)	Set the upper and lower limits of the gravity Y for an OK judgment.
	Master angle	Range: -180 to 180 (Default)	Sets the upper and lower limits of the master angle for an OK judgment.

Note

You can change the parameters for judgment conditions on the Display Settings Display. Press [◀] – [Display setting] on the right of the display to switch to the Display Settings Display.

3 Press [OK] to accept the value.

Unstable Labeling Results

The Desired Color Cannot Be Detected

Add a specific color or enlarge the color range.

Extraction Is Automatically Performed for an Undesired Color When Teaching

Manually set the color for which to measure the labeling.

► [Inspect] – [Inspection] – [Area] – [Modify] – [Settings] Tab Page – [Teach]

• Sensors with Color Cameras Only

1 Press [◀] – [Set color] on the right of the display.

2 Drag around the color for which you want to measure the labeling.

Labeling with that color will be automatically detected.

Continuous measurements will be performed for the images that are displayed.

Only the extracted color will appear on the display.

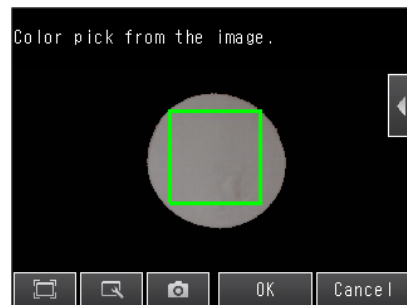

3 Press [OK].

4 Press [TEACH].

5 Press [Back] to end teaching.

Note

Measuring More Than One Color

Set the colors using the color palette.

Press [◀] – [Color palette] on the Set Color Display to display the color palette. Up to four colors can be specified.

If the *Color inv.* Option is selected, the color outside the region will become the selected color.

The [Inv.] Check Box applies to all colors. Select the [Exclusion] Check Box to exclude the selected color from extraction.

The order of exclusion is from the largest color palette number.

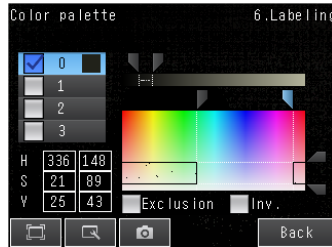

Making the Extract Color Easier to Check

- The display for the extracted color can be switched by using [◀] – [Display setting].
(The following display patterns can be selected for the extracted color: [Measurement image], [All color image] (Default), [Selected color image], or [Binary image].)
- Press [◀] – [Background color] to change the display for colors other than the extraction color.
(The color can be chosen from [Black] (Default), [White], [Red], [Green], or [Blue].)

• **Sensors with Monochrome Cameras (or for a Color Gray Filter)**

1 Press [◀] – [Binary level] on the right of the display.

2 Specify the range of brightness to detect, and then press [OK].

Specify the range of brightness to convert to a binary image. Measurement is performed after the image taken by the camera in 256-color grayscale is converted to a binary image. Then, white pixels are measured.

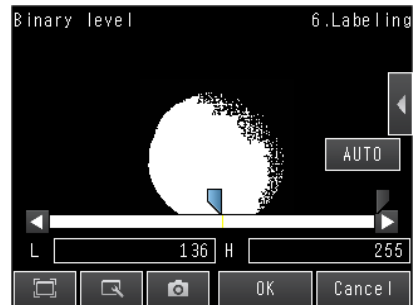

3 Press [OK].

4 Press [TEACH].

5 Press [Back] to end teaching.

Note

Making the Extraction Results Easier to Check

- You can invert the black/white extraction results.
Press [◀] – [Reverse] and select [Yes].
- You can select whether to display a binary image.
Press [◀] – [Binary image display] and select [OFF] or [ON].

Changing the Label Detection Conditions

You can fill in the labels detected through color extraction or binary conversion to perform a stable extraction of the labels and their characteristics or to mark only labels inside the measurement region for inspection.

► **[Inspect] – [Inspection] – [Labeling] – [Modify] – [Details] Tab Page – [Meas. Parameter]**

- 1 To enable filling up holes, press **[Filling up holes]** and select **[Yes]**.

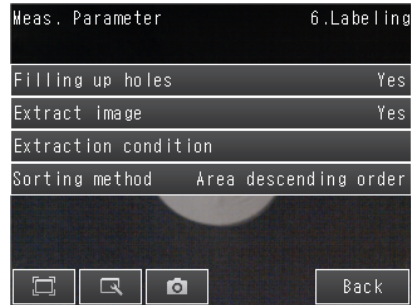

- 2 To extract an image, press **[Extract image]** and select **[Yes]**.

Parameter	Setting	Description
Filling up holes	Yes No (Default)	<p>Sets how to process areas surrounded by the specified color. If [Yes] is set, those areas are processed as the specified color.</p> <p>Input Image → Filled Image</p>
Extract image	Yes No (Default)	<p>Select this option if there are areas of the specified color inside the measurement region that you do not want to measure. If [Yes] is set, all areas outside the measurement region are cut out as the specified color.</p> <p>Measurement region</p> <p>You need to know the position and area of this label.</p> <p>You can find the position and area of the center label if you set the sort condition to sort by descending order of area. Areas outside the measurement region are set to the color for measurement.</p>

Changing the Label Extraction Conditions

Set the label extraction conditions. You can select to extract only labels that satisfy all four of the following: Number of labels, specified area, gravity X, and gravity Y conditions.

► [Inspect] – [Inspection] – [Labeling] – [Modify] – [Settings] Details – [Details] Tab Page – [Meas. Parameter] – [Extraction condition]

- 1 Press and set each of the parameters for the extraction conditions.

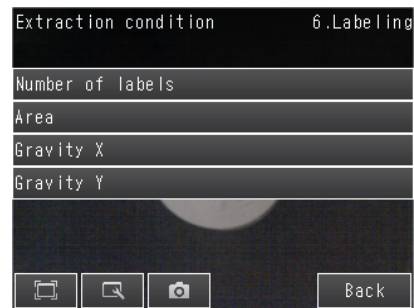

Parameter	Setting	Description
Number of labels	Range: 1 to 100 Default: 100	Set the maximum number of labels to detect.
Area	Range: 0 to 999,999,999.9999 Defaults: Upper limit: 999,999,999.9999 Lower limit: 0	Specify the area range to judge as a label.
Gravity X	Range: -99,999,999.9999 to 999,999,999.999 Defaults: Upper limit: 999,999,999.999, Lower limit: -999,999,999.9999	Specify the gravity X position to judge as a label.
Gravity Y	Range: -999,999,999.9999 to 999,999,999.999 Defaults: Upper limit: 999,999,999.999, Lower limit: -999,999,999.9999	Specify the gravity Y position to judge as a label.

Sorting Extracted Labels

Set the sort condition and count for extracted labels. You can set the sort condition and the maximum number of detections for detection results.

► [Inspect] – [Inspection] – [Labeling] – [Modify] – [Details] Tab Page – [Meas. Parameter]

1 Press [Sorting method].

2 Select the sorting method.

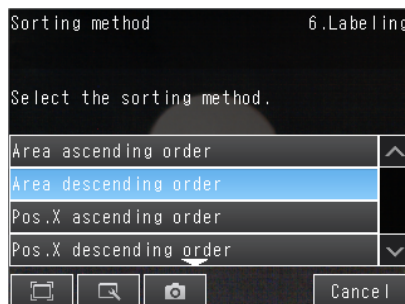

Parameter	Setting	Description
Sorting method	Area ascending order	Set the condition to use for label number reassignment. When sorting by X or Y coordinates, the upperleft corner is the origin.
	Area descending order (Default)	
	Pos. X ascending order (ascending order of X coordinate)	
	Pos. X descending order (descending order of X coordinate)	
	Pos. Y ascending order (ascending order of Y coordinate)	
	Pos. Y descending order (descending order of Y coordinate)	

Reflect in Total Judgement

You can specify whether to reflect the judgment results of an inspection item in the overall judgment. The Default is to reflect them.

► [Inspect] – [Inspection] – [Add item.] – [Labeling] – [Details] Tab Page – [Output parameter]

Editing the Measurement Region

This section describes how to edit the measurement regions. You can edit the measurement region in the same way as for a search region.

 *Changing the Model Registration Region to a Shape Other Than a Rectangle: p. 225*

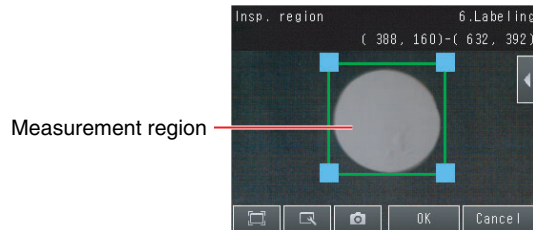

Important

If the measurement region is changed, perform teaching if required.  p. 312

Increasing the Processing Speed

Make the measurement region smaller to reduce the processing time.

 *Changing the Measurement Region p. 227*

Measurement Data That Can Be Used for External Outputs and Calculations

The following values can be used as measurement data and output to external devices via the Ethernet or used in calculations.

Expression text string	Data name	Description	Data range
JG	Judgement	-2: No judgement (not measured) 0: Judgement is OK -1: Judgement is NG -13: Teaching not performed error -14: Figure not registered error -15: Out of range error	This is the Labeling judgement results.
L	Number of labels	0 to 100	This is the number of labels found.
TAR	Total label area	0 to 999,999,999.9999	This is the total area of all labels found.
AR[0] to AR[99]	Area	0 to 999,999,999.9999	These are the areas of each individual label.
X[0] to X[99]	Gravity X	-99,999.9999 to 99,999.9999	-99,999.9999 to 99,999.9999 These are the X coordinates of the center of each label.
Y[0] to Y[99]	Gravity Y	-99,999.9999 to 99,999.9999	These are the Y coordinates of the center of each label.
ATH[0] to ATH[99]	Master angle	-180 to 180	These are the master angle of the center of each label.
SA	Reference area	0 to 999,999,999.9999	This is the reference area.
SX	Ref. position X (reference position X)	-99,999.9999 to 99,999.9999	This is the X coordinate of the reference position.
SY	Ref. position Y (reference position Y)	-99,999.9999 to 99,999.9999	This is the Y coordinate of the reference position.

 4-18 Calculations and Judgments Using Inspection Item Data p. 323

Measurement Data That Can Be Logged for Labeling

You can select to log any of the following values.

Measurement item	Range of value	Description
Judgement	0: Judgement is OK -1: Judgement is NG -13: Teaching not performed error -14: Figure not registered error -15: Out of range error	This is the measurement judgement results.
Number of labels	0 to 100	This is the number of labels.
Total label area	0 to 999,999,999.9999	This is the total area of all extracted labels.
Area	0 to 999,999,999.9999	This is the area of the detected label (100 max.).
Gravity center X	-99999.9999 to 99999.9999	This is the gravity coordinate X of the detected label (100 max.).
Gravity center Y	-99999.9999 to 99999.9999	This is the gravity coordinate Y of the detected label (100 max.).
Master angle	-180 to 180	This is the master angle of the detected label (100 max.).

* When logging data is output, the data is output in the order of the above table.
If more than one item is stored, results are output in order for each label.

Example:

[# of label] [Total label area] [Area 0.X] [Area 0.Y] [Gravity center 0.X] [Gravity center 0.Y] [Mater angle 0.ATH] ... [Area N.X] [Area N.Y] [Gravity center N.X] [Gravity center N.Y] [Master angle N.ATH] ... [Number of Label (Count-1).X] [Number of Label (Count-1).Y] [Number of Label (Count-1).TH]

 7-6 Logging Measurement Data and Image Data p. 392

4-18 Calculations and Judgments Using Inspection Item Data

FQ2-S1

FQ2-S2

FQ2-S3

FQ2-S4

FQ2-CH

You can set inspection item judgment results and measurement data with the Calculation menu command to use them in basic arithmetic operations and functions. The judgment results of the calculations are reflected in the overall judgment.

Calculation

Use the Calculation menu command to set the calculation expressions and the judgment parameters for the calculation results.

Expression

You can get up to 32 expressions. You can also combine expressions. You can use the following values in calculations.

- Filter item and position compensation item data (measurement data, reference values, and judgment results)
- Inspection item data (measurement data, reference values, and judgment results)
- Constants
- Other calculation results

Judgment

Upper and lower limit values are used for the judgment of calculation results (D00 to D31). If within the upper and lower limits, each calculation judgment result (J00 to J31) is OK. If all registered calculation results are judged OK, the judgment result (JG) is OK.

If there is at least one NG, the judgment result (JG) is NG. The judgment result (JG) of calculation can be reflected in the overall judgment.

(It is also possible to not reflect the judgment result in the output parameter(s) settings.)

Outputting the Calculation Results

The overall judgment (JG) of the calculations are reflected in the overall judgment of the inspection item. The calculation result of each expression (J00 to J31) and calculation data (D00 to D31) can be output via Ethernet or recorded as logging data.

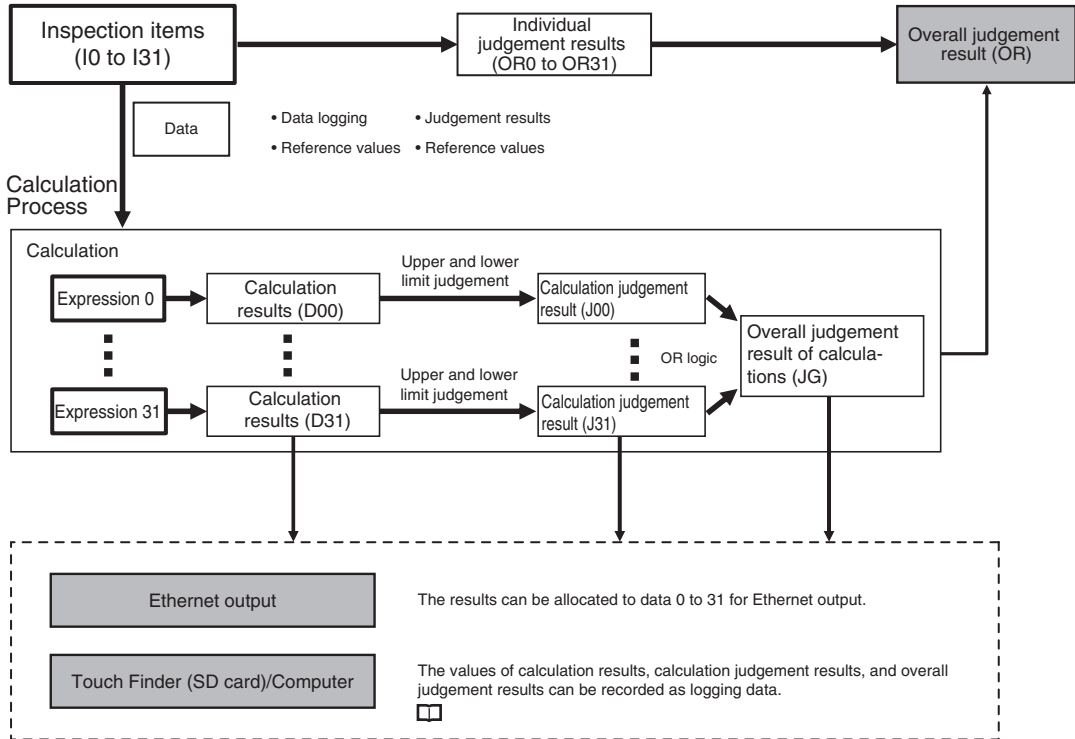

Examples for Calculation

Example 1: Finding the distance between two measured points

This example finds edge position 2 by detecting the two edge positions of inspection item 0 and inspection item 1, and calculates the distance between the two points.

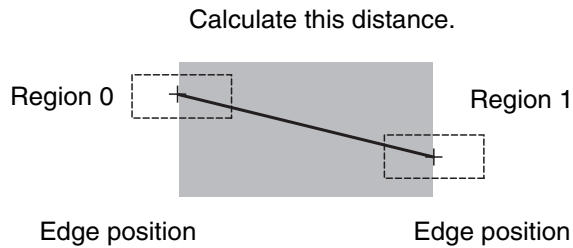

- Region 0 (edge position coordinates of inspection item 0): (I0.X,I0.Y)
- Region 1 (edge position coordinates of inspection item 1): (I1.X,I1.Y)
- Distance between two points = DIST (I0.X,I0.Y,I1X,I1.Y)

Example 2: Finding the lowest similarity of characters read with OCR inspection items

OCR items in inspection items 0 and 1 are used to find the lowest similarity of characters read.

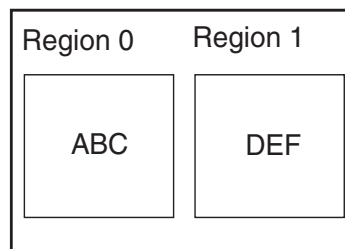

- Region 0 (similarity from OCR item in inspection item 0): (I0.SIM)
- Region 1 (similarity from OCR item in inspection item 1): (I1.SIM)
- Lowest similarity from OCR items in inspection items 0 and 1: min(I0.SIM,I1.SIM)

Procedure (Calculation)

- 1 Press [Inspect] – [Calculation].

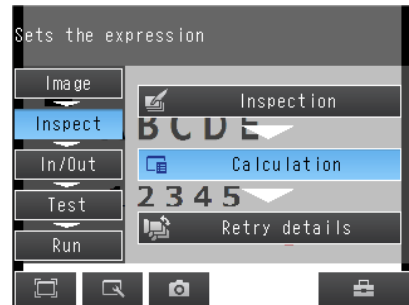

Setting Expressions

- 1 Press [Expression] on the [Settings] Tab Page.

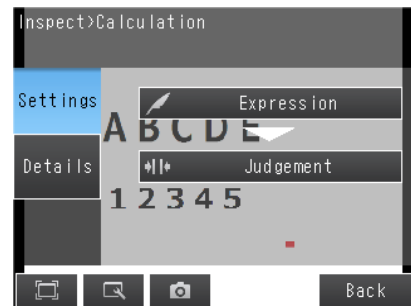

- 2 Press the expression number that you want to use.



3 Press [Modify] on the menu.

Note

Performing Similar Calculations At Different Locations

- [Rename] The name of the calculation can be changed. (16 characters max.)
- [Copy] Previously registered calculation expressions can be copied.



4 Set the expression by selecting items from the [Data], [Const.], and [Math.] Tab Pages.

The expression will be displayed in the space under [Expression settings].

Do not exceed 255 characters in the expression.

Item	Description
Const.	Press this to input constants or a mathematical operator. The following operators can be used: + (addition), - (subtraction), × (multiplication), and / (division).
Data	Press this to use measurement data, reference values, and judgment results of other items.
Math.	Press this to use functions.

Expression Notation

Expressions must have the following notation.

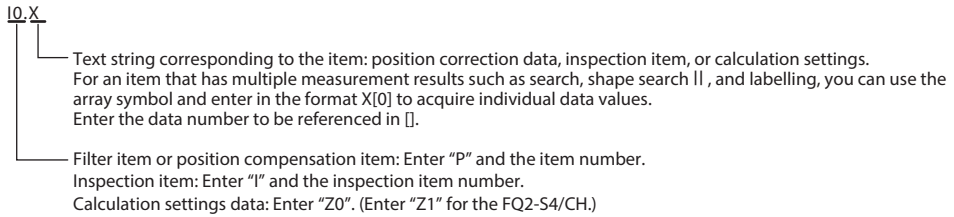

Example: Finding the distance between the centers of gravity of inspection item 1 and inspection item 2 using a function.

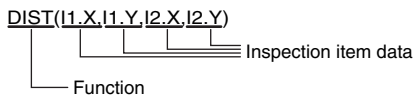

Example: Subtracting 120 from the calculation result of expression 0.

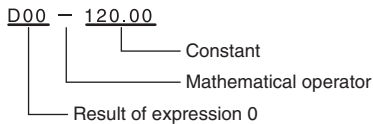

Example: Adding the judgement result of inspection items 0 and 1.

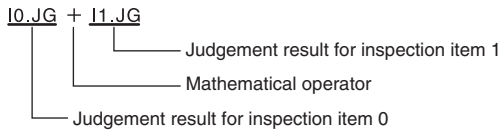

Example: Using an array to add the area of label 0 and the area of label 1 for inspection item 0 (labeling).

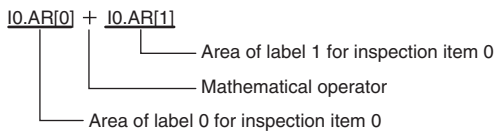

Function List

The following functions can be used in calculations.

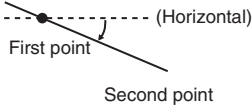
Function	Description
SIN	Finds the sine. The result is a value between -1 and 1 . The angle in the expression is in degrees. $SIN(\text{angle})$
COS	Finds the cosine. The result is a value between -1 and 1 . The angle in the expression is in degrees. $COS(\text{angle})$
ATAN	Finds the arctangent of the value (Y component, X component). The result is a radian value between $-\pi$ and π . $ANGL(Y_component, X_component)$ Example: Finding the angle between the straight line joining the centers of region 0 and region 1 and horizontal. $ATAN(R1.Y-R0.Y, R1.X-R0.X)$ If the two arguments are both 0, the result is 0 and the judgement is NG.
AND	Finds the logical AND. If one of the arguments is 0, the calculation result is 0. Otherwise it is -1 . $AND(\text{argument}_1, \text{argument}_2)$
OR	Finds the logical OR. If both of the arguments are 0, the calculation result is 0. Otherwise it is -1 . $OR(\text{argument}_1, \text{argument}_2)$
NOT	Applies a logical NOT operation. If the argument is 0, the calculation result is -1 . Otherwise it is 0. $NOT(\text{argument})$
ABS	Finds the absolute value. $ABS(\text{argument})$
MAX	Returns the larger of the two arguments. $MAX(\text{argument}_1, \text{argument}_2)$
MIN	Returns the smaller of the two arguments. $MAX(\text{argument}_1, \text{argument}_2)$
ANGL	Finds the angle of the straight line joining two points (the center of gravity and center of the model). The angle against the horizontal is found. The result is a value between -180 and 180 . $ANGL(Y_component, X_component)$ Example: Finding the angle of the straight line joining the centers of region 0 and region 1 $ANGL(R1.Y-R0.Y, R1.X-R0.X)$  If the two arguments are both 0, the result is 0 and the judgement is NG.
MOD	Finds the remainder after dividing a non-ordinal number with an ordinal number. $MOD(\text{non-ordinal}, \text{ordinal})$ If any of the arguments are real numbers, the decimals are rounded off before calculating the remainder. The remainder is the result of dividing integers. Example: $MOD(13,4)$... Result: 1 (remainder when 13 is divided by 4) $MOD(25.68, 6.99)$... Result: 5 (remainder when 26 is divided by 7)

Function	Description
SQRT	Finds the square root. If the argument is negative, the result is 0. The judgement will be NG. SQRT(<i>argument</i>)
DIST	<ul style="list-style-type: none"> Finds the distance between two points (the center of gravity and the center of the model). DIST(<i>first_position_X</i>, <i>first_position_Y</i>, <i>second_position_X</i>, <i>second_position_Y</i>) <p>Example: Finding the distance between the centers of gravity of region 0 and region 1 DIST(<i>R0.X</i>,<i>R0.Y</i>,<i>R1.X</i>,<i>R1.Y</i>)</p> <p>The following calculation is performed internally.</p> $\sqrt{(R1.X-R0.X)^2+(R1.Y-R0.Y)^2}$ <ul style="list-style-type: none"> Finds the length of a perpendicular line from point (x,y) to line $ax + by + c = 0$. DIST (<i>X_coordinate_of_point</i>, <i>Y_coordinate_of_point</i>, <i>coefficient_a_of_line</i>, <i>coefficient_b_of_line</i>, <i>coefficient_c_of_line</i>)

Setting Judgment Parameters for Expressions

- 1 Press [Judgement] on the [Settings] Tab Page.



- 2 Press an expression between 0 to 31 and set the corresponding judgement parameters using the slider.

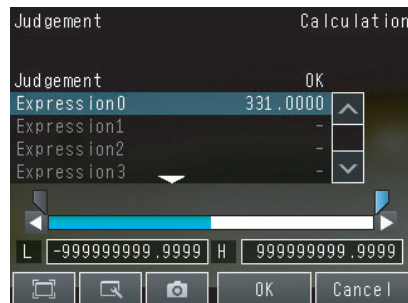

- 3 Press the [OK] Button.

Reflecting the Judgment Results for Expressions to the Overall Judgment Results

You can specify whether to reflect the judgment results of a calculation in the overall judgment.
(The Default is to reflect them.)

► **[Inspect]** – **[Calculation]** – **[Details] Tab Page** – **[Output parameter]** – **[Reflect]**

Inspection Item Data That Can Be Used in Expressions

Inspection item	Data name	Expression text string	Data range	Default
Filter (FQ2-S1/S2/S3/S4/CH)	Judgement	JG	-2: No judgement (not measured) 0: Judgement is OK -1: Judgement is NG	-2
	Judgement	JG	-2: No judgement (not measured) 0: Judgement is OK -1: Judgement is NG	-2
Shape Sear. pos. comp. (FQ2-S1/S2/S3/S4/CH)	Scroll X	DX	-99999.9999 to 99999.9999	0
	Scroll Y	DY	-99999.9999 to 99999.9999	0
	Scroll θ	DT	-180 to 180	0
	Position X	X	-99999.9999 to 99999.9999	0
	Position Y	Y	-99999.9999 to 99999.9999	0
	Angle	TH	-180 to 180	0
	Reference X	SX	-99999.9999 to 99999.9999	0
	Reference Y	SY	-99999.9999 to 99999.9999	0
	Reference angle	ST	-180 to 180	0
	Correlation	CR	0 to 100	0
Search position comp. (FQ2-S1/S2/S3/S4/CH)	Judgement	JG	-2: No judgement (not measured) 0: Judgement is OK -1: Judgement is NG	-2
	Scroll X	DX	-99999.9999 to 99999.9999	0
	Scroll Y	DY	-99999.9999 to 99999.9999	0
	Position X	X	-99999.9999 to 99999.9999	0
	Position Y	Y	-99999.9999 to 99999.9999	0
	Reference X	SX	-99999.9999 to 99999.9999	0
	Reference Y	SY	-99999.9999 to 99999.9999	0
Correlation	CR	0 to 100	0	
Edge position comp. (FQ2-S1/S2/S3/S4/CH)	Judgement	JG	-2: No judgement (not measured) 0: Judgement is OK -1: Judgement is NG	-2
	Scroll X	DX	-99999.9999 to 99999.9999	0
	Scroll Y	DY	-99999.9999 to 99999.9999	0
	Ref. position X	X	-99999.9999 to 99999.9999	0
	Ref. position Y	Y	-99999.9999 to 99999.9999	0
	Reference X	SX	-99999.9999 to 99999.9999	0
Reference Y	SY	-99999.9999 to 99999.9999	0	

Inspection item	Data name	Expression text string	Data range	Default
2Edge position comp. (FQ2-S1/S2/S3/S4/CH)	Judgement	JG	-2: No judgement (not measured) 0: Judgement is OK -1: Judgement is NG	-2
	Scroll X	DX	-99999.9999 to 99999.9999	0
	Scroll Y	DY	-99999.9999 to 99999.9999	0
	Edge0 position X	X0	-99999.9999 to 99999.9999	0
	Edge0 position Y	Y0	-99999.9999 to 99999.9999	0
	Edge1 position X	X1	-99999.9999 to 99999.9999	0
	Edge1 position Y	Y1	-99999.9999 to 99999.9999	0
	Edge0 ref. position X (edge 0 reference position X)	SX0	-99999.9999 to 99999.9999	0
	Edge0 ref. position Y (edge 0 reference position Y)	SY0	-99999.9999 to 99999.9999	0
	Edge1 ref. position X (edge 1 reference position X)	SX1	-99999.9999 to 99999.9999	0
	Edge1 ref. position Y (edge 1 reference position Y)	SY1	-99999.9999 to 99999.9999	0
2Edge midpoint comp. (FQ2-S1/S2/S3/S4/CH)	Judgement	JG	-2: No judgement (not measured) 0: Judgement is OK -1: Judgement is NG	-2
	Scroll X	DX	-99999.9999 to 99999.9999	0
	Scroll Y	DY	-99999.9999 to 99999.9999	0
	Edge0 position X	X0	-99999.9999 to 99999.9999	0
	Edge0 position Y	Y0	-99999.9999 to 99999.9999	0
	Edge1 position X	X1	-99999.9999 to 99999.9999	0
	Edge1 position Y	Y1	-99999.9999 to 99999.9999	0
	Midpoint X	MX	-99999.9999 to 99999.9999	0
	Midpoint Y	MY	-99999.9999 to 99999.9999	0
	Edge0 ref. position X (edge 0 reference position X)	SX0	-99999.9999 to 99999.9999	0
	Edge0 ref. position Y (edge 0 reference position Y)	SY0	-99999.9999 to 99999.9999	0
	Edge1 ref. position X (edge 1 reference position X)	SX1	-99999.9999 to 99999.9999	0
	Edge1 ref. position Y (edge 1 reference position Y)	SY1	-99999.9999 to 99999.9999	0
	Ref. midpoint X (reference midpoint X)	SMX	-99999.9999 to 99999.9999	0
Ref. midpoint Y (reference midpoint Y)	SMY	-99999.9999 to 99999.9999	0	

Inspection item	Data name	Expression text string	Data range	Default
Edge rot. pos. Comp. (FQ2-S1/S2/S3/S4/CH)	Judgement	JG	-2: No judgement (not measured) 0: Judgement is OK -1: Judgement is NG	-2
	Scroll θ	DT	-180 to 180	0
	Edge0 position X	X0	-99999.9999 to 99999.9999	0
	Edge0 position Y	Y0	-99999.9999 to 99999.9999	0
	Edge1 position X	X1	-99999.9999 to 99999.9999	0
	Edge1 position Y	Y1	-99999.9999 to 99999.9999	0
	Angle	TH	-180 to 180	0
	Edge0 ref. position X (edge 0 reference. position X)	SX0	-99999.9999 to 99999.9999	0
	Edge0 ref. position Y (edge 0 reference. position Y)	SY0	-99999.9999 to 99999.9999	0
	Edge1 ref. position X (edge 1 reference. position X)	SX1	-99999.9999 to 99999.9999	0
	Edge1 ref. position Y (edge 1 reference. position Y)	SY1	-99999.9999 to 99999.9999	0
	Reference angle	STH	-180 to 180	0
Numerical Position Compensation (FQ2-S1/S2/S3/S4/CH)	Judgement	JG	-2: No judgment (not measured) 0: Judgement is OK -1: Judgement is NG -15: Out of range error	-2
	Position correction X	DX	-99999.9999 to 99999.9999	0
	Position correction Y	DY	-99999.9999 to 99999.9999	0
	Position correction θ	DT	-180 to 180	0
	Measurement coordinate X	X	-99999.9999 to 99999.9999	*1
	Measurement coordinate Y	Y	-99999.9999 to 99999.9999	*1
	Measurement angle	TH	-180 to 180	0
	Reference coordinate X	SX	-99999.9999 to 99999.9999	*1
	Reference coordinate Y	SY	-99999.9999 to 99999.9999	*1
Reference angle	ST	-180 to 180	90	
OCR (FQ2-S4/CH only)	Judgement	JG	-2: No judgment (not measured) 0: Judgement is OK -1: Judgement is NG -16: Measurement timeout error -17: Format not entered error	-2
	Index	IN	-2: No verification pastern, or reading error -1: Verification is NG 0 to 31: Master data No.	-2
	Number of read characters	N	0 to 128	0
	Similarity	SIM	0 to 100	0
	Stability	STB	0 to 100	0
	Number of read characters (line 1) N1	N1	32 characters max.	0
	Number of read characters (line 2) N2	N2	32 characters max.	0
	Number of read characters (line 3) N3	N3	32 characters max.	0
Number of read characters (line 4) N4	N4	32 characters max.	0	

Inspection item	Data name	Expression text string	Data range	Default
OCR (FQ2-S4/CH only)	Individual similarity	SMC	0 to 100	0
	Individual stability	SBC	0 to 100	0
Bar code (FQ2-S4 only)	Judgement	JG	-2: No judgement (not measured) 0: Judgement is OK -1: Judgement is NG -16: Measurement timeout error	-2
	Index No.	IN	-2: No verification pastern or reading error -1: Verification is NG, 0 to 31: Master data No.	-2
	Num. of char.	N	0 to 1024	0
2D-code (FQ2-S4 only)	Judgement	JG	-2: No judgement (not measured), 0: Judgement is OK -1: Judgement is NG -16: Measurement timeout error	-2
	Index No.	IN	-2: Verification OFF or reading error -1: Verification is NG 0 to 31: Master data No.	-2
	Num. of char.	N	0 to 1024	0
	Overall quality	GD0	0 to 4	0
	Decode	GD1	0 to 4	0
	Cell contrast	GD2	0 to 4	0
	Cell modulation	GD3	0 to 4	0
	Fixed pattern damage	GD4	0 to 4	0
	Axial nonuniformity	GD5	0 to 4	0
	Grid nonuniformity	GD6	0 to 4	0
	Unused err. Corr.	GD7	0 to 4	0
	Print scale	GD8	0 to 4	0
	Print scale X	GD9	0 to 4	0
Print scale Y	GD10	0 to 4	0	

*1: Depends on the model. Refer to *Compensating for Position Offset (Position Compensation Items): p. 102.*

Inspection item	Data name	Expression text string	Data range	Default
2D-code (DPM) (FQ2-S4 only)	Judgement	JG	-2: No judgement (not measured) 0: Judgement is OK -1: Judgement is NG -16: Measurement timeout error	-2
	Index No.	IN	-2: Verification OFF or reading error, -1: Verification is NG, 0 to 31: Master data No.	-2
	Num. of char.	N	0 to 1024	0
	Cell Recog. Rate	E	0 to 100	0
	Contrast	C	0 to 100	0
	Focus	F	0 to 100	0
	Cell size	P	Depends on the size of the code being read	0
	Overall quality	GDA0	0 to 4	0
	Decode	GDA1	0 to 4	0
	Cell contrast	GDA2	0 to 4	0
	Cell modulation	GDA3	0 to 4	0
	Fixed pattern damage	GDA4	0 to 4	0
	Axial nonuniformity	GDA5	0 to 4	0
	Grid nonuniformity	GDA6	0 to 4	0
Unused err. Corr.	GDA7	0 to 4	0	
Search (FQ2-S1/S2/S3/S4 only)	Judgement	JG	-2: No judgement (not measured) 0: Judgement is OK -1: Judgement is NG -13: Teaching not performed error -14: Figure not registered error -15: Out of range error	-2
	Correlation	CR[0] to CR[31]	0 to 100	0
	Position X	X[0] to X[31]	-99999.9999 to 99999.9999	0
	Position Y	Y[0] to Y[31]	-99999.9999 to 99999.9999	0
	Angle	TH[0] to TH[31]	-180 to 180	0
	Reference X	SX	-99999.9999 to 99999.9999	0
	Reference Y	SY	-99999.9999 to 99999.9999	0
	Reference angle	ST	-180 to 180	0
	Detection X	RX	-99999.9999 to 99999.9999	0
	Detection Y	RY	-99999.9999 to 99999.9999	0
	Count	C	0 to 32	0

Inspection item	Data name	Expression text string	Data range	Default
Shape Search II Shape Search III (FQ2-S1/S2/S3/S4 only)	Judgement	JG	-2: No judgement (not measured) 0: Judgement is OK -1: Judgement is NG -13: Teaching not performed error -14: Figure not registered error -15: Out of range error	-2
	Correlation	CR	0 to 100	0
	Position X	X	-99999.9999 to 99999.9999	0
	Position Y	Y	-99999.9999 to 99999.9999	0
	Angle	TH	-180 to 180	0
	Reference X	SX	-99999.9999 to 99999.9999	0
	Reference Y	SY	-99999.9999 to 99999.9999	0
	Reference angle	ST	-180 to 180	0
	Detection X	RX	-99999.9999 to 99999.9999	0
	Detection Y	RY	-99999.9999 to 99999.9999	0
	Count	C	0 to 32	0
Sensitive Search (FQ2-S1/S2/S3/S4 only)	Judgement	JG	-2: No judgement (not measured) 0: Judgement is OK -1: Judgement is NG -13: Teaching not performed error -14: Figure not registered error -15: Out of range error	-2
	Correlation	CR	0 to 100	0
	Density	DV	Color image: 0 to 221	0
			Monochrome image: 0 to 127	0
	Position X	X	-99999.9999 to 99999.9999	0
	Position Y	Y	-99999.9999 to 99999.9999	0
	Angle	TH	-180 to 180	0
	Detection X	RX	-99999.9999 to 99999.9999	0
	Detection Y	RY	-99999.9999 to 99999.9999	0
	Ref. position X (reference position X)	SX	-99999.9999 to 99999.9999	0
	Ref. position Y (reference position Y)	SY	-99999.9999 to 99999.9999	0
	Reference angle	ST	-180 to 180	0
	NG sub-region	CT	0 to 100	0
	Sub-region number	AN	1 to 99	0
	Sub-region number(X)	ANX	0 to 9	0
	Sub-region number(Y)	ANY	0 to 9	0
	Sub-region pos.X (sub-region position X)	DX	-99999.9999 to 99999.9999	0
	Sub-region pos.Y (sub-region position Y)	DY	-99999.9999 to 99999.9999	0
	Correlation (sub-region)	CRN[0] to CRN[80]	0 to 100	0
	Deviation (sub-region)	DVN[0] to DVN[80]	Color image: 0 to 221	0
Monochrome image: 0 to 127			0	

Inspection item	Data name	Expression text string	Data range	Default
Edge Position (FQ2-S1/S2/S3/S4 only)	Judgement	JG	-2: No judgement (not measured) 0: Judgement is OK -1: Judgement is NG -13: Teaching not performed error -14: Figure not registered error -15: Out of range error	-2
	Position X	X	-99999.9999 to 99999.9999	0
	Position Y	Y	-99999.9999 to 99999.9999	0
	Ref. position X (reference position X)	SX	-99999.9999 to 99999.9999	0
	Ref. position Y (reference position Y)	SY	-99999.9999 to 99999.9999	0
	Offset amount	DF	-99999.9999 to 99999.9999	0
Edge Width (FQ2-S1/S2/S3/S4 only)	Judgement	JG	-2: No judgement (not measured) 0: Judgement is OK -1: Judgement is NG -13: Teaching not performed error -14: Figure not registered error -15: Out of range error	-2
	D. edge width	DF	0 to 99999.9999	0
	Ref. edge width	SW	0 to 99999.9999	0
	Edge width	W	0 to 99999.9999	0
Edge Pitch (FQ2-S1/S2/S3/S4 only)	Judgement	JG	-2: No judgement (not measured) 0: Judgement is OK -1: Judgement is NG -13: Teaching not performed error -14: Figure not registered error -15: Out of range error	-2
	Edge pitch	N	0 to 999	0
	Average pitch	P	0 to 99999.9999	0
	Max. pitch (maximum pitch)	PH	0 to 99999.9999	0
	Min. pitch (minimum pitch)	PL	0 to 99999.9999	0
	Average width	W	0 to 99999.9999	0
	Max width (maximum width)	WH	0 to 99999.9999	0
	Min width (minimum width)	WL	0 to 99999.9999	0
Color Data (FQ2-S1/S2/S3/S4 only)	Judgement	JG	-2: No judgement (not measured) 0: Judgement is OK -1: Judgement is NG -10: Image error -20: Other error	-2
	R average	AR	0 to 255	0
	G average	AG	0 to 255	0
	B average	AB	0 to 255	0
	Color diff./dens. Av. (color difference/density average)	AD	Color difference: 0 to 442 Density average: 0 to 255	0
	Clr deviat. (color deviation/density deviation)	DV	Color difference: 0 to 221 Density deviation: 0 to 217	0

Inspection item	Data name	Expression text string	Data range	Default
Area (FQ2-S1/S2/S3/S4 only)	Judgement	JG	-2: No judgement (not measured) 0: Judgement is OK -1: Judgement is NG -13: Teaching not performed error -14: Figure not registered error -15: Out of range error	-2
	Area	AR	0 to 999999999.9999	0
	Gravity X	X	-99999.9999 to 99999.9999	0
	Gravity Y	Y	-99999.9999 to 99999.9999	0
	Reference area	SA	0 to 999999999	0
	Ref. position X (reference position X)	SX	-99999.9999 to 99999.9999	0
	Ref. position Y (reference position Y)	SY	-99999.9999 to 99999.9999	0
Labeling (FQ2-S1/S2/S3/S4 only)	Judgement	JG	-2: No judgement (not measured) 0: Judgement is OK -1: Judgement is NG -13: Teaching not performed error -14: Figure not registered error -15: Out of range error	-2
	Number of labels	L	0 to 100	0
	Area	AR[0] to AR[99]	0 to 999999999.9999	0
	Gravity X	X[0] to X[99]	-99999.9999 to 99999.9999	0
	Gravity Y	Y[0] to Y[99]	-99999.9999 to 99999.9999	0
	Reference area	SA	0 to 999999999.9999	0
	Ref. position X (reference position X)	SX	-99999.9999 to 99999.9999	0
	Ref. position Y (reference position Y)	SY	-99999.9999 to 99999.9999	0
	Total label area	TAR	0 to 999999999.9999	0
Master angle	ATH[0] to ATH[99]	-180 to 180	0	

Testing and Saving Settings

5-1 Performing Test Measurements	340
5-2 Shortening the Measurement Takt Time	342
5-3 Adjusting the Judgment Parameters.....	346
5-4 Checking a List of All Inspection Item Results.....	349
5-5 Saving Data to the Sensor	350

5-1 Performing Test Measurements

FQ2-S1

FQ2-S2

FQ2-S3

FQ2-S4

FQ2-CH

After completing the settings in the [Image], [Inspect], and [In/Out] Tab Pages, move to the [Test] Tab Page. The displayed image is measured automatically. This is called a test measurement.

A test measurement is used to verify that the settings that have been made will produce stable results and, if necessary, to fine-tune the settings. An overall judgment of all inspection items can be performed.

Test measurements can be performed for through images (Default) or saved images.

Performing Test Measurements with Samples

► [Test] – [Continuous test]

- 1 Press [Graphics+Details].
- 2 Input an image of a previously prepared object. Check the judgement results.
- 3 When you finish checking the results, press [Back].



Note

• The same five types of displays are available for the [Continuous test] on the [Test] Tab Page, i.e., [Graphics], [Graphics + Details], [All results/region], [Trend monitor], and [Histogram]. Press the [Back] Button to access the menu to change the display.

📖 *Changing the Run Mode display: p. 354*

• [Trend monitor] and [Histogram] are shown when the File Logging function is enabled.

📖 *Enabling File Logging: p. 399*

Performing Test Measurements with Saved Images (Re-measuring)

This Sensor can save measured images in the Sensor's built-in memory or on an SD card. Test measurements can be performed using these saved images.

This function is useful for adjusting the judgment parameters when objects are not available.

► [Test] – [Continuous test] – (Any display)

1 Press  – .

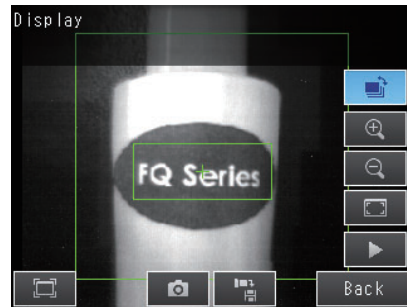

2 Select one of the following.

- [Log]: Images that are logged in the Sensor's internal memory.
- [Logging image file]: Images that are logged in the SD card.
- [Camera image file]: Images that were saved as logged images with the  (Log Image) Button.

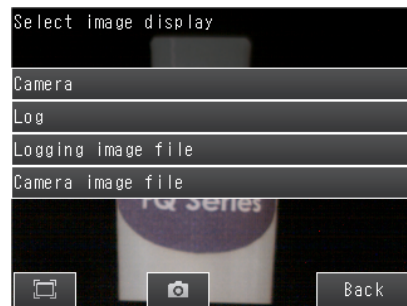

3 The display switches to the saved image and measurements are taken again.

 *Saving images: p. 420*



5-2 Shortening the Measurement Takt Time

FQ2-S1

FQ2-S2

FQ2-S3

FQ2-S4

FQ2-CH

Checking the Measurement Takt Time

The measurement time of this Sensor can be checked from the Setup or Run Mode display.

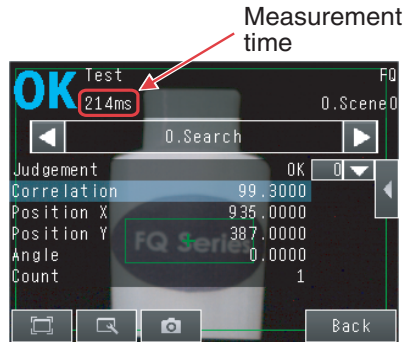

The measurement time is the time taken from when a trigger is input until when all measurement processes are executed.

During the measurement time, this Sensor will not accept the next trigger. This means that the measurement time is the basic measurement takt time.

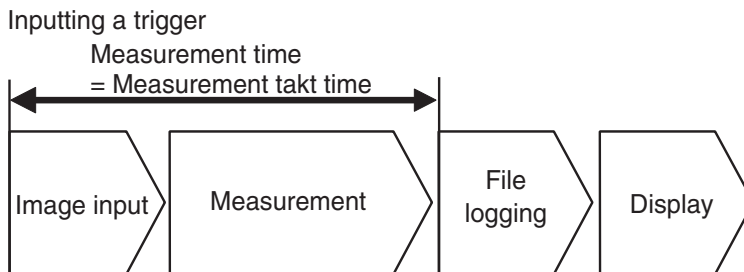

Increasing Image Input Speed

With the partial input function, it is possible to input only images that are in the region that is necessary for measurements.

The image measurement region becomes smaller and therefore the image input time is shortened.

Consider the offset in the measurement object when you set the range.

The image in the input range will be displayed in the inspection item setting displays and measurement displays.

• FQ2-S3/S4

► [Image] – [Camera setup]

- 1 Press [◀] – [Partial input] on the right side of the display.
- 2 Press [Y] and set the input range along the Y axis by setting the Y coordinate of the partial input start point and the Y coordinate of the partial input end point.
- 3 Press [X] and set the input range along the X axis by setting the X coordinate of the partial input start point and the X coordinate of the partial input end point.
- 4 Press [OK].

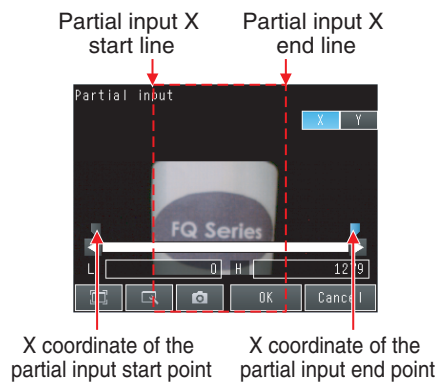
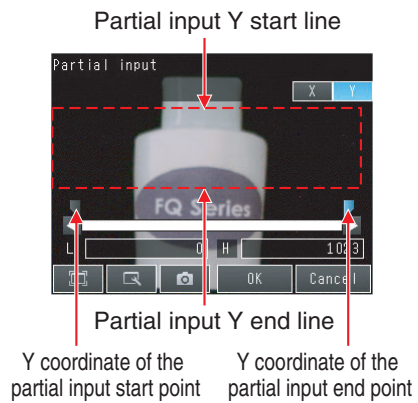

Parameter	Setting	Description
X coordinate of the partial input start point	FQ2-S□□□□□□-08□ Range: 176 to 1,088, Default: 176	Specify the partial input range along the X axis.
	FQ2-S□□-□□□ Range: 0 to 1,264, Default: 0	
X coordinate of the partial input end point	FQ2-S□□□□□□-08□□ Range: 191 to 1,103, Default: 1,103	
	FQ2-S□□-□□□ Range: 15 to 1,279, Default: 1,279	
Y coordinate of the partial input start point	FQ2-S□□□□□□/FQ2-S□□□□□□-M Range: 0 to 472, Default: 0	Specify the partial input range along the Y axis.
	FQ2-S□□□□□□-08□ Range: 98 to 918, Default: 98	
Y coordinate of the partial input end point	FQ2-S□□-□□□ Range: 0 to 1,016, Default: 0	
	FQ2-S□□□□□□/FQ2-S□□□□□□-M Range: 7 to 479, Default: 479	
	FQ2-S□□□□□□-08□ Range: 105 to 925, Default: 925	
	FQ2-S□□□□□□ Range: 7 to 1,023, Default: 1,023	

Note

- The minimum input widths are 16 for the X axis and 8 for the Y axis.
- The values of the monitor display positions are displayed for the coordinates in the measurement results.
- The coordinate values will not change as a result of the partial input settings.

Important

If you use partial input, perform teaching again. Partial input on the X axis is supported only by the FQ2-S3□□□□/FQ2-S4□□□□□□/□□□□/□□□□□□/□□□□□□-M.

• FQ2-S1/S2/CH

▶ [Image] – [Camera setup]

1 Press [◀] – [Partial input] on the right side of the display.

2 Change the input size.

3 Press [OK].

4 Press [Back].



Changing the Image Input Mode

Pixel sampling can be applied to the input image to reduce image input time.

▶ [Image] – [Camera setup] – ◀ – [Image input mode]

Parameter	Setting	Description
Image Input Mode	High-speed Standard (Default)	Pixel sampling can be applied to the input image to reduce image input time.

Important

If you change the image input mode, perform teaching again.

5-3 Adjusting the Judgment Parameters

FQ2-S1

FQ2-S2

FQ2-S3

FQ2-S4

FQ2-CH

Adjusting Judgment Parameters While Looking at Measurement Results

If correct judgments are not possible, you can move directly from the Setup Mode display to the judgment parameters display to make adjustments.

► [Test] – [Continuous test] – (Either display)

1 Press [◀] – [Adjust judgement] on the right of the display.

2 Press the parameters and adjust the values of the judgment conditions for them.

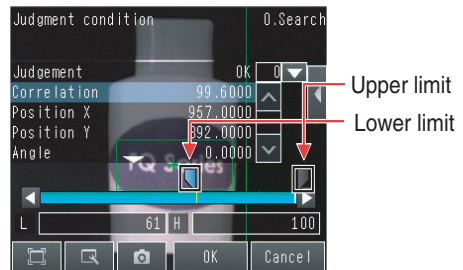

Setting Up the Best Judgement Parameters Automatically

The judgment parameters of the selected inspection items can be automatically adjusted by using actual workpieces which are considered as good and faulty products.

► [Test] – [Continuous test]

1 Move to the inspection item for which you want to automatically adjust the judgement parameters and press [◀] – [Adjust judgement] on the right side of the display.

2 Press [◀] – [Auto adjustment].

3 Display a sample image of a good object and press [OK Teach]. Display a sample image of a bad object and press [NG Teach].

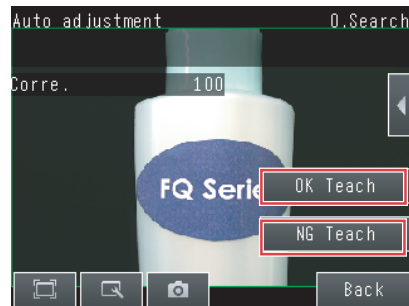

4 Repeat these steps for at least three samples each.

5 Press [Back].

The best judgement parameters will be set automatically.

6 Press [OK].

Important

There are no judgment condition settings for the following inspection items.

- Bar code and 2D-code (FQ2-S4 series only)
- Labelling and Edge pitch (FQ2-S1/S2/S3/S4 series only)

Note

You can select one of the following three patterns as the judgment method.

► [◀] – [Select the method.] on the right side of the display

- 1) Threshold (minimum): The lower limit of the variations between OK object is used as the judgment condition.
- 2) Threshold (average): The median value between the OK object variations and NG object variations is used as the judgement condition.
- 3) Threshold (maximum): The upper limit of the variations between NG object is used as the judgment condition.

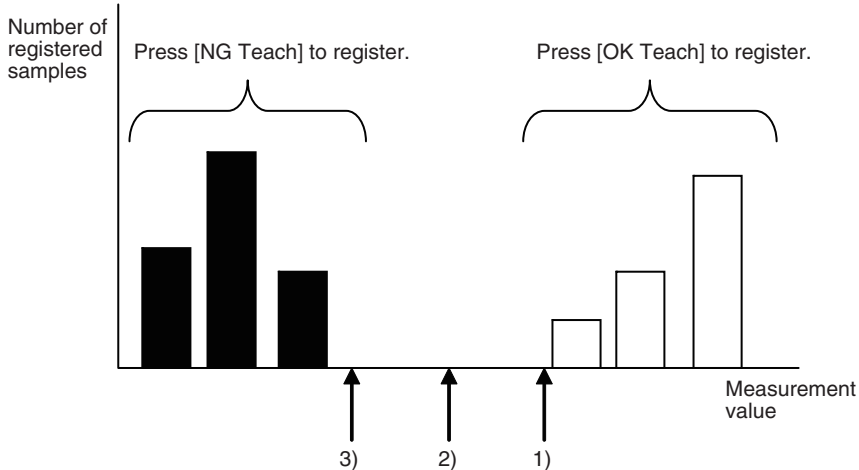

5-4 Checking a List of All Inspection Item Results

FQ2-S1

FQ2-S2

FQ2-S3

FQ2-S4

FQ2-CH

Individual judgment results for all inspection items can be checked in a list. The individual inspection items can be selected to change the judgment parameters.

► [Test] – [Continuous test]

1 Press [All results/region] to display the list.

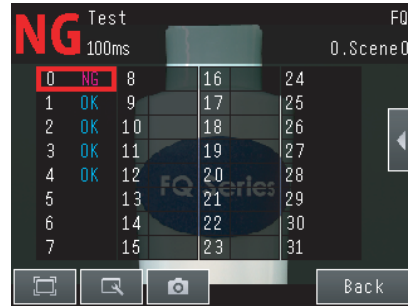

Note

Judgement parameters can also be changed from this display. Select an inspection item and press [◀] – [Adjust judgement].

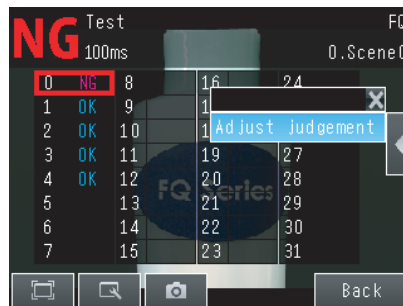

5-5 Saving Data to the Sensor

FQ2-S1

FQ2-S2

FQ2-S3

FQ2-S4

FQ2-CH

Until you have saved your settings explicitly to the memory in the FQ2 Sensor, the settings are only stored temporarily. They will be lost if the power is turned OFF. Execute [Save data] after you have finished making your settings.

The FQ2 Sensor will remind you to do so with a message if you switch from Setup Mode to Run Mode. You can use this feature to keep the previous settings and discard the new settings if desired, but keep in mind that all settings that are not saved explicitly are replaced by the settings that are stored in the memory of the FQ2 Sensor the next time you turn ON the FQ2 Sensor.

Important

Do not turn the power supply OFF while data is being saved. The data that is being saved may become corrupted.

► [Test]

1 Press [Save data].

2 Press [Yes].

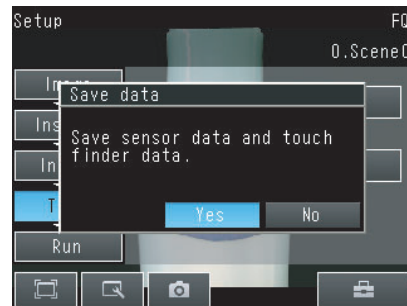

Note

- The data that are saved by this operation are scene data, system data, calibration data, touch finder data, and dictionary data*1.

*1: Only supported on the FQ2-S4/CH Series.

📖 *Scene data and system data details: p. 407*

- Measurement data and image data cannot be saved in this way.

📖 *Logging measurement data: p. 392*

- Settings data can also be backed up to an external memory.

📖 *Saving settings: p. 406*

Operation

6-1 Starting Operation	352
6-2 Configuring the Run Mode Display	354
6-3 Checking the Trend of Measurement Results with Graphs.	358
6-4 Adjusting Judgement Parameters during Operation.	362
6-5 Editing the Model Region / Measurement Region from Run Mode	363

6-1 Starting Operation

FQ2-S1

FQ2-S2

FQ2-S3

FQ2-S4

FQ2-CH

When test measurements and adjustments in Setup Mode have been finished, change to Run Mode and begin actual measurements. In Run Mode, the Sensor operates stand-alone and outputs the measurement judgment results on the I/O lines accordingly to the settings. If the Touch Finder or the PC Tool is connected via network to the Sensor, the operation of the Sensor can be monitored in the following ways.

Run Mode Display

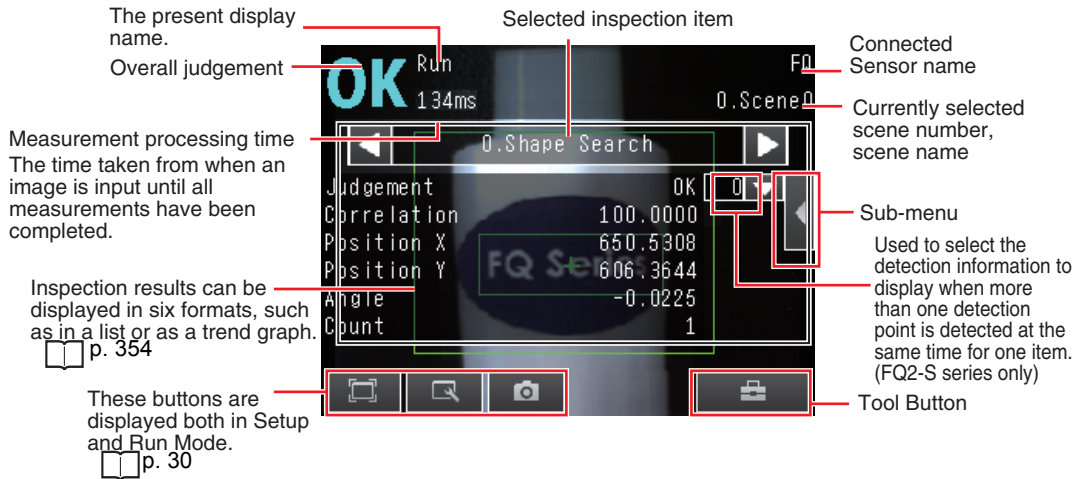

Moving to Run Mode

You can move from Setup Mode to Run Mode by using the following procedure.

1 Press [Run].

2 Press [Switch to Run mode.].

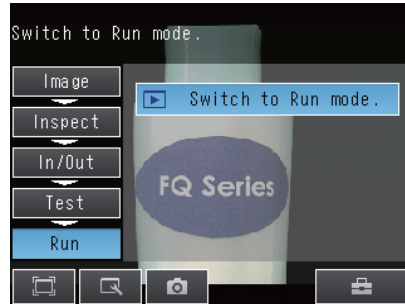

3 Press [Yes].

If you press [No], the setting will not be saved and you will move to Run Mode.

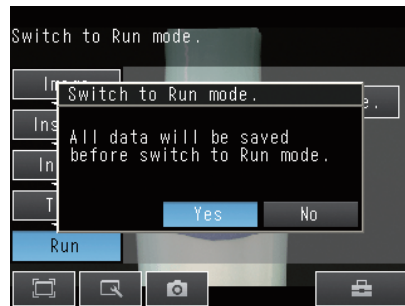

Note

- Returning to Setup Mode

Press  and press [Sensor settings].

- Signal Status When Moving to Run Mode

When moving to Run Mode, the signal will change as shown below and data can be input from and output to an external device.

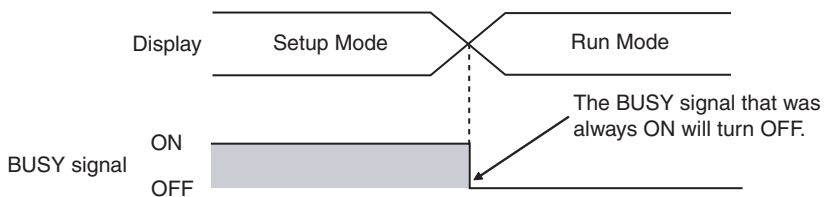

6-2 Configuring the Run Mode Display

FQ2-S1

FQ2-S2

FQ2-S3

FQ2-S4

FQ2-CH

There are six types of displays that can be used, as shown below. Select the display as desired.

Checking the Judgement Results of Inspection Items

Graphics



The image and region currently being measured will appear.

Graphics + Details

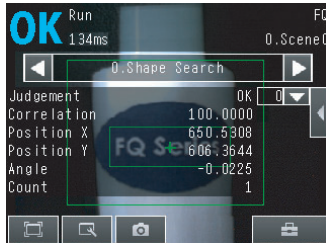

In addition to [Graphics] display, individual judgement results and measurement values of selected inspection items will appear.

Checking the Overall Judgement Result History

Statistical data



The currently measured image and history of the overall judgement results (measurement count, NG count, and NG rate) will appear.

Checking the Judgements of All Inspection Items in a List

All results/region



The judgement results of all inspection items can be checked in a list.

Displaying Measurement Result Histories

Trend monitor

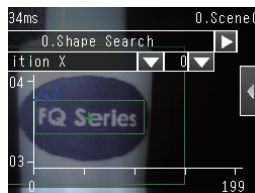

The statistical data for the currently selected inspection item can be checked against time.

p. 358

Histogram

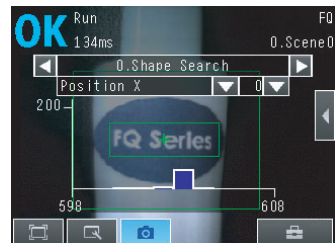

The distribution of measurement results of the currently selected inspection item can be checked.

p. 360

▶ (Run Mode) – [Select display]

Note

The two conditions below are required in order to display the trend monitor / histograms in Run Mode.

Enabling File Logging: p. 399

Setting Logging Conditions: p. 395

The following displays are convenient if more than one Sensor is connected.

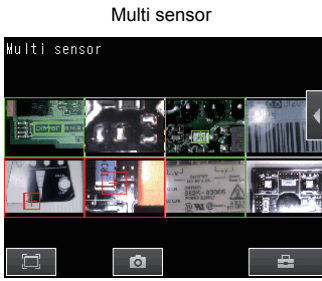

Displays the measurement results of all connected Sensors.
Green display: OK, Red display: NG

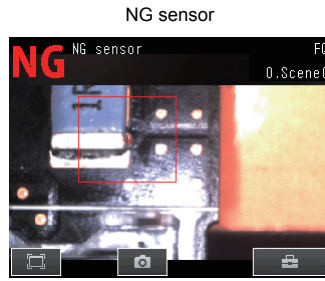

Automatically changes to the display for any Sensor with an NG result.

▶  (Run Mode) – [Sensor monitor]

When multiple sensors are connected, switching from [Sensor monitor] to [Single Sensor], [Multi sensor], or [NG sensor] is possible.

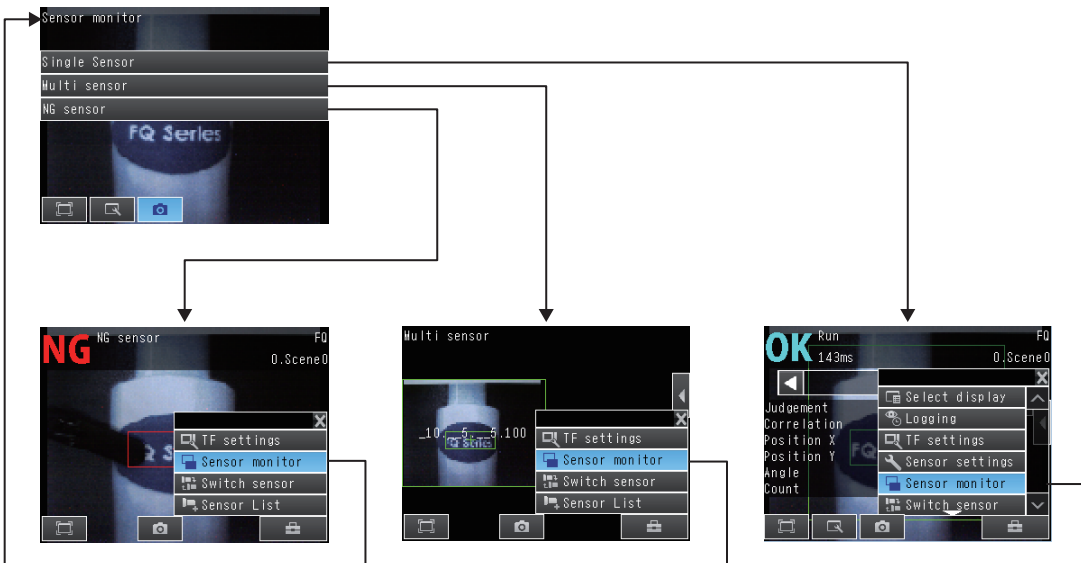

Specifying the Startup Run Mode Display

The display that appears when power supply is turned ON can be set. The Default setting is [Graphics + Details]. This only appears when [Start screen type] under [Startup display] is set to [Single sensor].

▶ (Setup Mode or Run Mode) – [TF settings] – [Startup display] – [Display pattern]

Note

- You can set the scene to be displayed when the power supply is turned ON.

 *Setting the Startup Scene: p. 368*

- The Default display setting for startup can be changed.

 *Selecting the Display When More Than One Sensor Is Connected: p. 389*

Displaying the Inspection Item Results

You can scroll through the measurement results of all the configured inspection items by using the following operations.

Switches to the previous inspection item.
Switches to the next inspection item.



Note

The following are also displayed in addition to the measurement results for each inspection item.

- Filter item: The results of a filter item is displayed.
- Camera input: The image that is being measured is displayed.
- Position comp.: The result of position compensation is displayed.
- All Region: The measurement regions for all inspection items are displayed.
- Calculation: The calculation result of each expression registered in the inspection settings is displayed.

Clearing the Measurement Result

You can clear the measurement results of all the configured inspection items by using the following operations.

▶  (Run Mode) – ◀ – [Clear results]

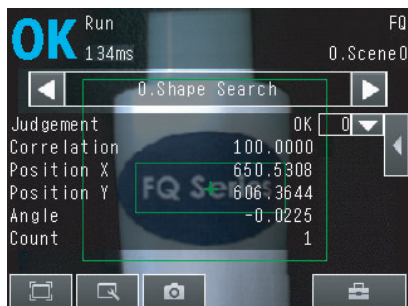

Selecting the Displayed Image

You can select the displayed image when you use the Area or Labeling Inspection items,

▶  (Run Mode) – ◀ – [Display Setting]

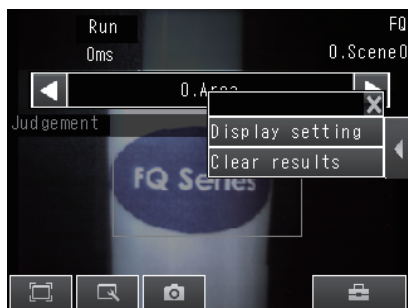

The selectable image will be changed depending on the Sensor type.

Color type

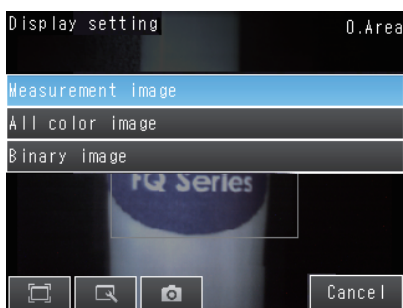

You can select from Measurement image, All color image and Binary image.
(Default : Measurement image)

Monochrome type

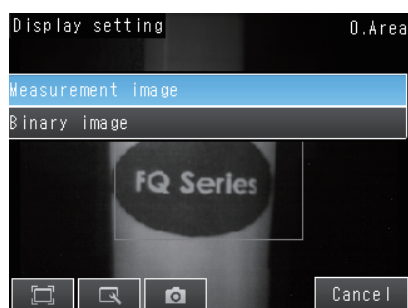

You can select from Measurement image and Binary image.
(Default : Measurement image)

6-3 Checking the Trend of Measurement Results with Graphs

FQ2-S1 FQ2-S2 FQ2-S3 FQ2-S4 FQ2-CH

Measurement result histories can be checked using the trend monitor and histograms.

To display trend monitors or histograms in Run Mode, you must make the following setting in advance in Setup Mode.

- ▶  (Setup Mode) – [TF settings] – [Logging setting] – [ON]

Trend Monitor

Changes in the measurement values of the selected inspection item against time can be observed from the graph. It becomes possible to predict when malfunctions may occur or to analyze the cause of the malfunction by checking the trends in the measurement values. The most recent 1,000 measurement values are displayed on the graph.

• [Trend monitor] Display

Switches the display to the previous inspection item number.

Specifies the parameters to display on the Trend Monitor.

Measurement values

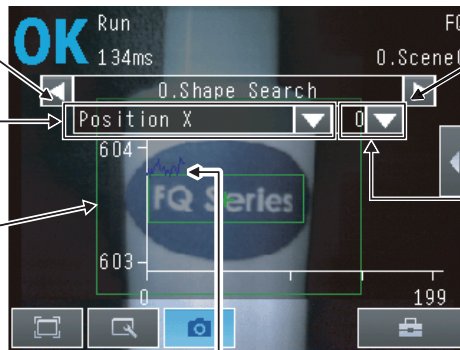

Switches the display to the next inspection item number.

Used to select the detection information to display when more than one detection point is detected at the same time for one item. (FQ2-S series only)

Changes in the measured value of the selected inspection item are displayed against time in a graph.

- ▶  (Run Mode) – [Select display] – [Trend monitor]

Arranging the Trend Monitor Display

The display range for the vertical axis and display conditions for the horizontal axis can be changed. To change the display range of the vertical axis, [Auto display] must be set to OFF.

Note

You can display only one parameter in the Trend Monitor. You cannot display multiple parameters at the same time.

• Disabling Automatic Adjustment of the Display Range (Default: ON)

- 1 Press [◀] – [Auto display] on the right of the trend monitor.
- 2 Press [OFF].

• Changing the Display Range of the Vertical Axis

- 1 Press [◀] – [Display range] on the right of the trend monitor.
- 2 Set the minimum and maximum values of the measurement values.

• Changing the Number of Values That Are Displayed

- 1 Press [◀] – [Number of data] on the right of the trend monitor.
- 2 Select the number of values from 200, 400, and 1,000.

Note

- Trend monitor data is held until the power supply is turned OFF.
- You can select whether to display all data on the trend monitor or only data for which the overall judgement is NG. Logging settings are applied to the trend monitor as well. However, they are not applied to trend monitor when it is displayed in Setup Mode.

 Check recent measurement trends (recent results logging): p. 401

Histograms

The distribution of each measurement value can be checked on a histogram.
The most recent 1,000 measurement values are displayed on a graph.

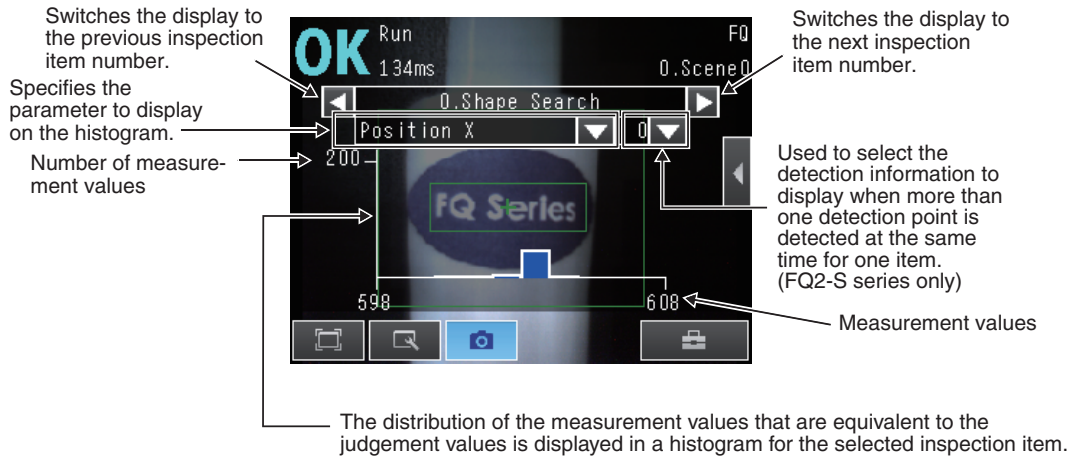

▶  (Run Mode) – [Select display] – [Histogram]

Arranging Histogram Display

The display range on the horizontal axis and the number of data on the vertical axis of the histogram can be changed. To change the display range of the vertical axis, [Auto display] must be set to OFF.

- **Disabling Automatic Adjustment of the Display Range (Default: ON)**

- 1 Press [\blacktriangleleft] – [Auto display] on the right of the histogram.
- 2 Press [OFF].

- **Changing the Display Range of the Horizontal Axis**

- 1 Press [\blacktriangleleft] – [Display range] on the right of the histogram.
- 2 Select the maximum measurement value, the minimum measurement value, and the class.

- **Changing the Number of Data on the Vertical Axis**

- 1 Press [\blacktriangleleft] – [Number of data] on the right of the histogram.
- 2 Select the maximum number of data to display.

Note

-
- Histogram data is held until the power supply is turned OFF.
 - You can select whether to display all data in the histogram or only data for which the overall judgment is NG. Logging settings are applied to the histogram as well. However, they are not applied to histograms displayed in Setup Mode.

 *Check recent measurement trends (recent results logging): p. 401*

6-4 Adjusting Judgement Parameters during Operation

FQ2-S1

FQ2-S2

FQ2-S3

FQ2-S4

FQ2-CH

This Sensor enables judgment parameters to be adjusted while measurements are being performed. Downtime can be eliminated with this feature because the production line does not have to be stopped while making adjustments.

Preparations

This function is switched OFF as a Default to prevent it from inadvertently working during operation. Turn ON the function if you want to use it.

▶  (Setup Mode) – [Sensor settings] – [Adjustment mode in Run]

1 Press [ON].

Changing the Judgment Parameters in Run Mode

This section describes how to change the judgment parameters without stopping measurement in Run Mode.

▶ Run Mode

1 Select the inspection item or position compensation item for which you want to adjust the judgment parameters using the ◀ and ▶ Buttons.

2 Press [◀] – [Adjust judgement].

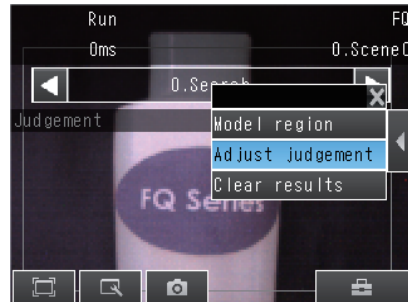

3 Press the parameters and change the values of the judgment conditions for them with the slider.

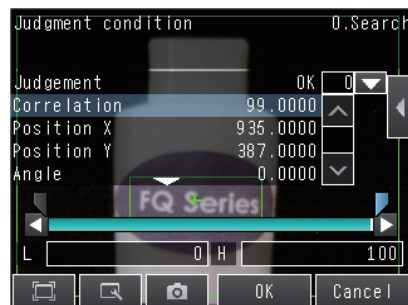

4 Press [OK].
The judgement results with the changed judgment parameters will appear.

Important

The changed judgment parameters will not be reflected in the measurement result until [OK] is pressed.

6-5 Editing the Model Region / Measurement Region from Run Mode

FQ2-S1

FQ2-S2

FQ2-S3

FQ2-S4

FQ2-CH

With this Sensor, you can move from Run Mode to the model edit / measurement region edit display. This eliminates the need to move to Setup Mode, making it easier to edit the model region / measurement region. The procedure for editing the model region are explained below. The measurement region can be edited in the same way.

Preparations

In the Default state, this function is turned OFF to prevent accidental operation in Run Mode. To use the function, first turn it ON.

▶  (Setup Mode) – [Sensor settings] – [Adjustment mode in Run]

1 Press [ON].

Editing the Model Region from Run Mode

The procedure for editing the model region from Run Mode is explained below.

1 Use the  and  Buttons to select the inspection item whose model region you want to adjust.

2 Press [] – [Model region].

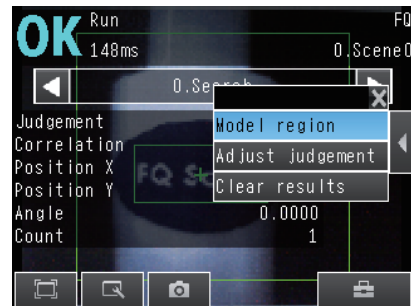

3 Change the model region.

4 Press [OK].



Important

The BUSY signal is ON during model region editing. Take care that this does not affect the line.

MEMO

Convenient Functions

7-1 Changing the Scene to Change the Line Process	366
7-2 Calibration.....	369
7-3 Display Functions	380
7-4 Monitoring the Signal I/O Status	385
7-5 Connecting to More Than One Sensor.....	386
7-6 Logging Measurement Data and Image Data.....	392
7-7 Saving Sensor Settings	406
7-8 SD Card Operations	409
7-9 Convenient Functions for Operation.....	413
7-10 Convenient Functions for Setup.....	420
7-11 Setting the Retry Function.....	422
7-12 Functions Related to the System.....	427

7-1 Changing the Scene to Change the Line Process

FQ2-S1

FQ2-S2

FQ2-S3

FQ2-S4

FQ2-CH

What Are Scenes?

With an FQ2 Sensor, the inspection items that can be processed at the same time are registered as scenes. A command input from an external device or a touch panel operation can be used to select a certain scene. If a scene is registered for each type of measurement object or inspection, the line process can be changed simply by changing the scene when the measurement object or inspection changes.

Example: FQ2-S Series

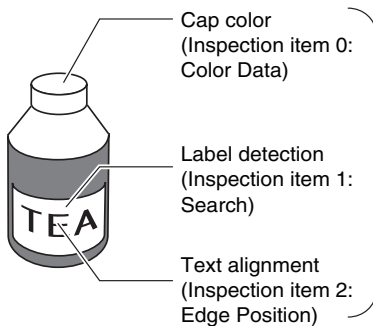

Example: FQ2-S4/CH Series

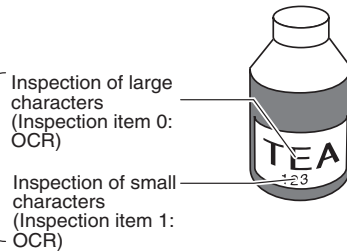

These can be
registered
as one scene.

Line Process Changes:

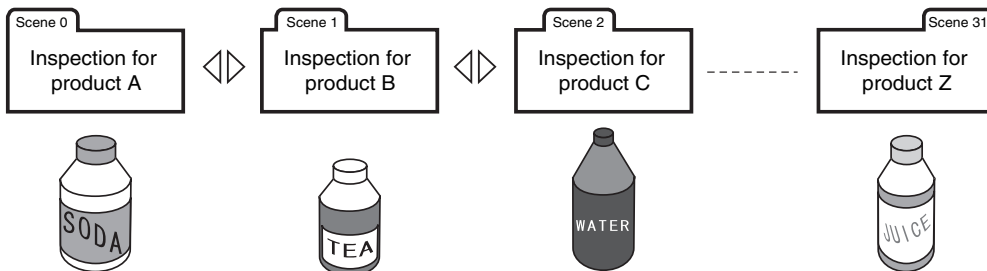

• Maximum Number of Scenes

Item	FQ2-S2/S3/S4/CH Series	FQ2-S1 Series
Number of scenes	32	8

• Settings Included with Scenes

The settings that are changed by switching scenes are the Camera image ([Image] Tab Page) and Inspection Items ([Inspect] Tab Page) output data settings. Settings related to external I/O specifications and the system settings for the Sensor are used in common for all scenes.

Refer to the following information for the data that is included in the scene data.

9-1 Menu Tables: p. 438

Creating New Scenes

The Default scene number is 0. To create another scene, use the following procedure to switch the scene and then make the settings.

► (Setup Mode) – [Select scene]

- 1** Press the number of the scene to change to and then press [Select].
- 2** The scene will change. Make the settings for the scene.

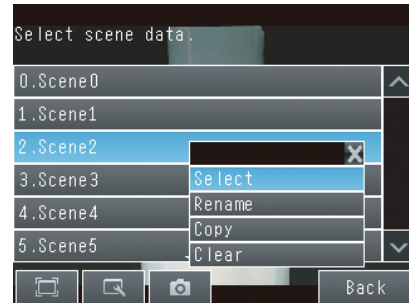

Changing Scene Names, Copying Scenes, and Deleting Scenes

► (Setup Mode) – [Select scene]

- 1** Press the number of the scene and then press [Rename], [Copy], or [Clear].
- 2** To change the name, enter a new scene name in 15 alphanumeric characters or less.
To copy a scene, press the number of the scene to copy.

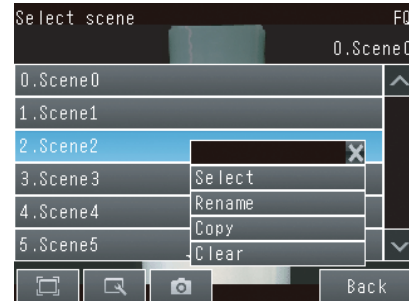

Switching Scenes from an External Device

- Changing Scenes by Parallel Input Command

 *Vision Sensor FQ2-S/CH Series User's Manual for Communications Settings (Cat. No. Z338)*
Section 2 Controlling Operation and Outputting Data with a Parallel Connection

- Changing Scenes by PLC Link Command

 *Vision Sensor FQ2-S/CH Series User's Manual for Communications Settings (Cat. No. Z338)*
3-2 Controlling Operation and Outputting Data with PLC Link Communications

- Changing Scenes by EtherNet/IP Command

 *Vision Sensor FQ2-S/CH Series User's Manual for Communications Settings (Cat. No. Z338)*
3-1 Controlling Operation and Outputting Data with EtherNet/IP Communications

- Changing Scenes by TCP No-protocol Command or a UDP No-protocol Command

 *Vision Sensor FQ2-S/CH Series User's Manual for Communications Settings (Cat. No. Z338)*
3-4 Control and Output in No-protocol (TCP) / No-protocol (UDP)

- Changing Scenes by FINS/TCP No-protocol Command

 *Vision Sensor FQ2-S/CH Series User's Manual for Communications Settings (Cat. No. Z338)*
3-5 Controlling Operation and Outputting Data with FINS/TCP No-protocol Commands

- Changing scenes by PROFINET command

 *Vision Sensor FQ2-S/CH Series User's Manual for Communications Settings (Cat. No. Z338)*
3-3 Outputting Data and Controlling Operation through PROFINET

Setting the Startup Scene

▶  **(Setup Mode) – [Sensor settings] – [Startup settings]**

The following items can be set.

Item	Purpose	Setting range
Startup mode	Select whether the startup scene number is set manually.	ON OFF (The scene number when the settings were saved will be the startup scene number. The startup mode is set to OFF in the Default settings.)
Startup scene	Set the scene number to use at startup.	Standard models: 0 to 31 Single-function models: 0 to 8, Default: 0

7-2 Calibration

FQ2-S1

FQ2-S2

FQ2-S3

FQ2-S4

Calibration

Calibration is used to convert Camera coordinates into actual coordinates.
You can set calibration to output the detected position in the actual coordinates.

You can convert pixels to actual dimensions and then output them.

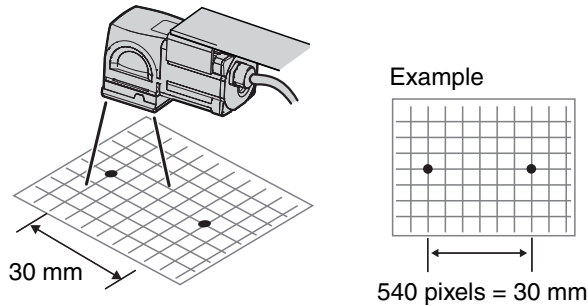

You can also compensate for offsets in the origin and coordinate system.

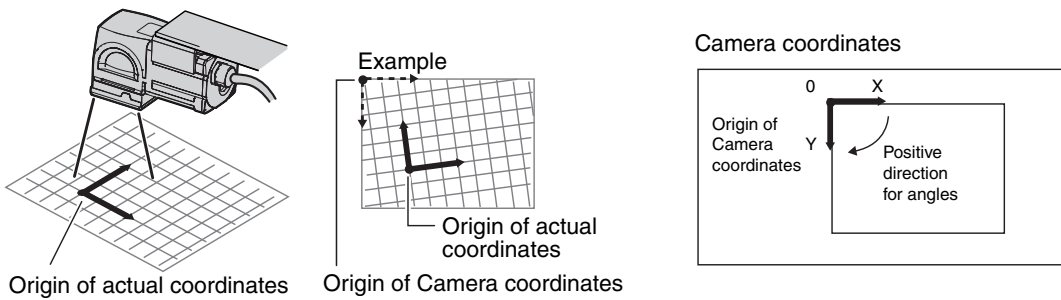

• Calibration Conversion Methods

There are the following three conversion methods for calibration.

Point specification: You can enter the actual pixel coordinates of any position.

Reference: You can measure a registered model and then enter the actual coordinates of the model.

Parameter: You can enter the calibration values directly.

• Setting Calibration

Use the following procedure to set calibration.

1 Set the conversion method to use for calibration.

Select the calibration method (point specification, reference, or parameter) and enter the actual coordinates or other values that are suitable for the selected method.

You can register up to 32 calibration patterns.

Calibration type	Description	
Specify point (point specification)	Specify from three to nine points and enter their actual coordinates.	p. 371
Reference sampling (reference)	Search for a registered model and enter the actual coordinates of the position where the model is detected.	p. 374
Parameter	Enter the numeric values of the parameters directly to calculate the calibration data.	p. 377

2 Select the calibration pattern to use.

Select the calibration pattern to use from the calibration settings.

 *Selecting the Calibration Pattern to Use: p. 379*

Note

You can set the calibration setting for each scene.

You can use the same calibration setting for different scenes or use a different calibration setting for each scene.

Setting the Calibration Pattern

Point Specification

Set the pixel coordinates of positions to set the calibration pattern.

When you enter the actual coordinates of the specified positions, the calibration parameters are automatically calculated.

You can register the coordinates of up to nine positions.

• Different Magnifications in X and Y Directions

Specify three positions.

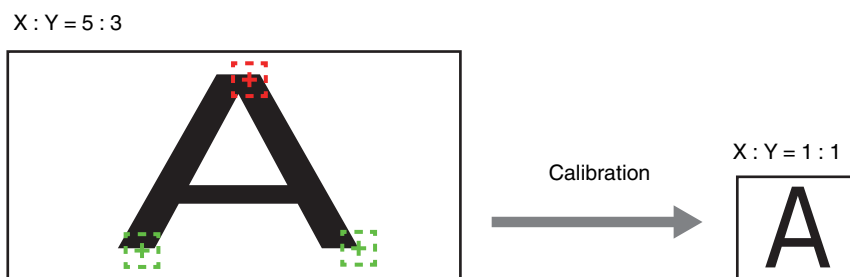

Note

Calibration cannot be performed using two places. Specify at least three places.

► (Setup Mode) – [Calibration]

- 1 Select the data region to set from [Calibration data 0] to [Calibration data 31].
- 2 Press [Modify].
- 3 Press [◀] – [Specify point] on the right of the display.

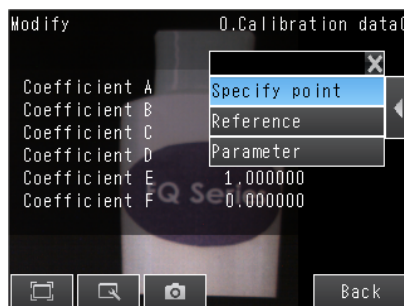

4 Press [No. 1] and then press [Modify].

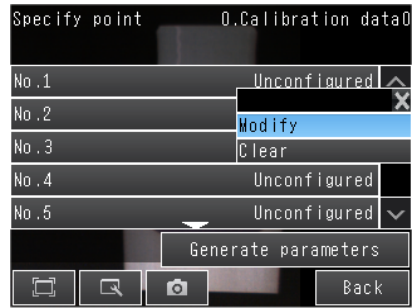

5 Press the Camera coordinates to register on the display to select them.

A cross mark will be displayed on the selected position.



Note

- You can enlarge the display.

Image Zoom: p. 380

- You can fine-tune the coordinates that are set.
Press [◀] – [Console] on the right of the display.
Press the Cross Key on the console to change the coordinates one pixel at a time.

6 Press [OK].

7 Enter the actual coordinates of the specified position.

Press [◀] – [Actual coord.] on the right of the display.

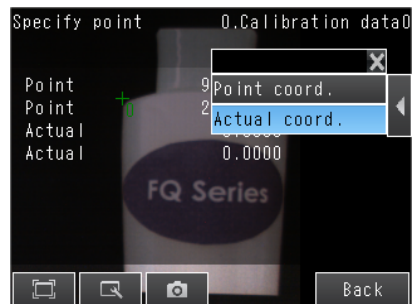

- 8** Enter the actual X and Y coordinates, and then press [OK].

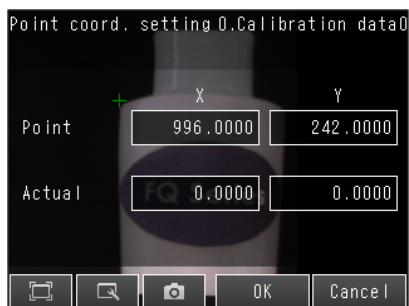

- 9** Repeat the above steps 4 to 8 to set the coordinates of the remaining positions.

- 10** When you have finished setting the coordinates for all of the positions, press [Generate parameters].

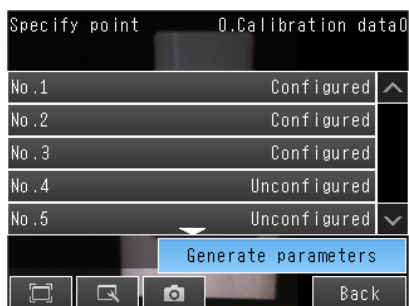

- 11** The calibration parameters will be displayed.

The items in the calibration parameters are listed in the following table.

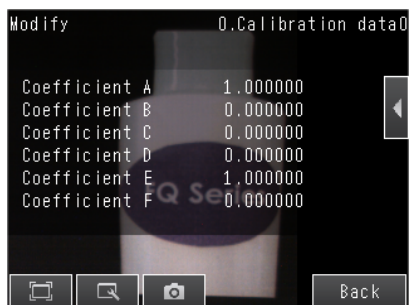

Item	Setting	Description
A	Calculated value	These are the calibration conversion values. These values are used to convert the Camera coordinates to the actual coordinates. The following formulas are used to convert to actual coordinates. (X,Y): Camera coordinates of measurement position, Unit: pixels (X',Y'): Converted coordinates (actual coordinates) $X' = A \times X + B \times Y + C$ $Y' = D \times X + E \times Y + F$
B	Calculated value	
C	Calculated value	
D	Calculated value	
E	Calculated value	
F	Calculated value	

Reference

With this method, the calibration settings are based on measurement results.

When you enter the actual coordinates of the position that results from searching for a registered model, the calibration parameters are calculated automatically.

(The position resulting from the search is found at the subpixel level.)

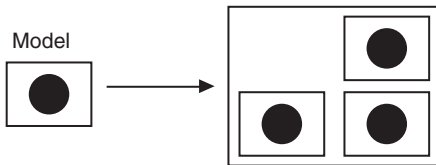

Measure three positions and enter the actual coordinates of them.

▶ (Setup Mode) – [Calibration]

- 1 Select the data region to set from [Calibration data 0] to [Calibration data 31].
- 2 Press [Modify].
- 3 Press [◀] – [Reference] on the right of the display.
- 4 Press [No. 1] and then press [Modify].

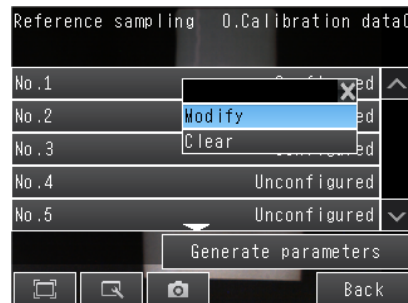
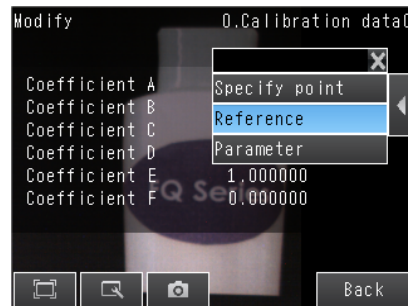

- 5 Move the rectangular frame to specify the model region.**

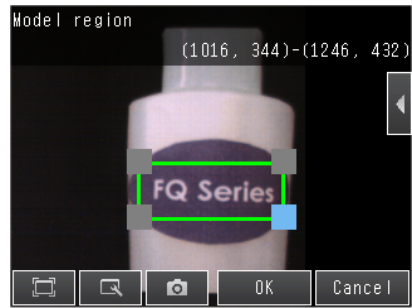

Note

- You can edit the model region.
The procedure is the same as that for the search function.

 Editing the Model and Measurement Regions: p. 224

- 6 Press [OK].**

- 7 Press a reference sample to get the Camera coordinates.**

- 8 Enter the actual coordinates of the specified position.**

Press [\blacktriangleleft] – [Actual coord.] on the right of the display.

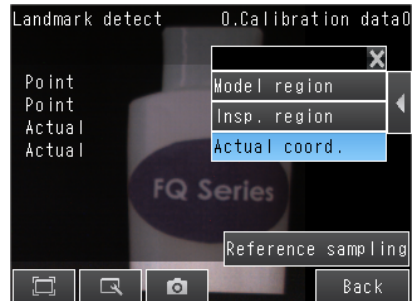

- 9** Enter the actual X and Y coordinates and press [OK].

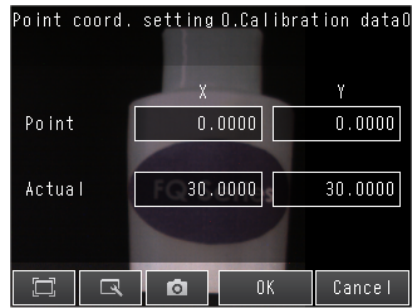

- 10** Repeat the above steps 4 to 8 to set the coordinates of the remaining positions.

- 11** When you have finished setting the coordinates for all of the positions, press [Generate parameters].

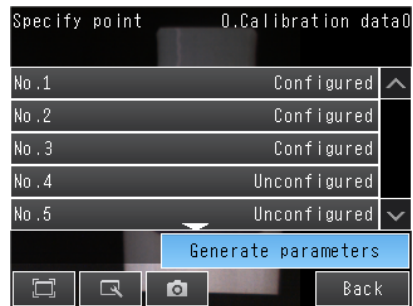

- 12** The calibration parameters will be displayed. The items in the calibration parameters are the same as those for point specification.

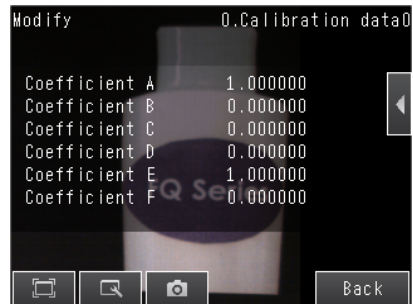

Parameter

With this method, you directly enter values to set calibration.

The calibration parameters will be automatically calculated when you enter the following three parameters.

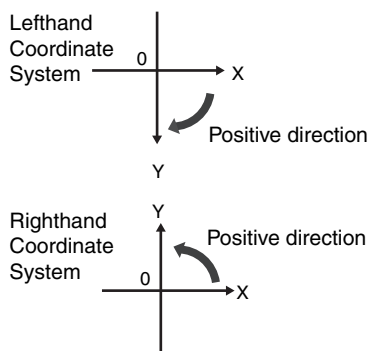
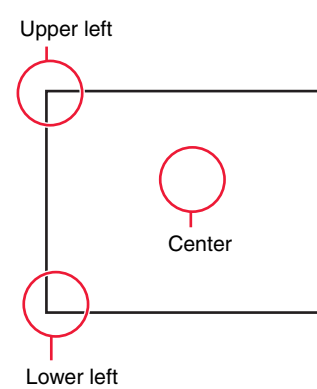
Parameter	Setting	Description
Coordinate (coordinate system)	<ul style="list-style-type: none"> • Righthand • Lefthand (Default) 	<ul style="list-style-type: none"> • Lefthand: The positive direction is clockwise when coordinates are specified. • Righthand: The positive direction is counterclockwise when coordinates are specified. 
Origin	<ul style="list-style-type: none"> • Upperleft (Default) • Lowerleft • Center 	<p>Select the location of the origin of the coordinate system.</p> 
Magnification	0.0001 to 9.9999 Default: 1.0000	Set the actual dimension that corresponds to one pixel.

►  (Setup Mode) – [Calibration]

1 Select the data region to set from [Calibration data 0] to [Calibration data 31].

2 Press [Modify].

3 Press [Left Arrow] – [Parameter] on the right of the display.

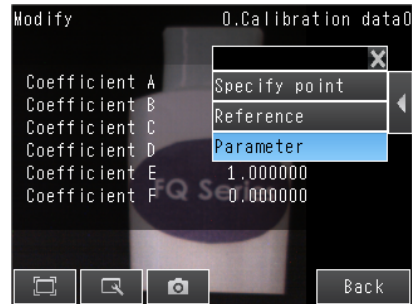

4 Set the following parameters: [Coordinate], [Origin], and [Magnification].

5 Press [OK].



6 The calibration parameters will be displayed.
The items in the calibration parameters are the same as those for point specification.

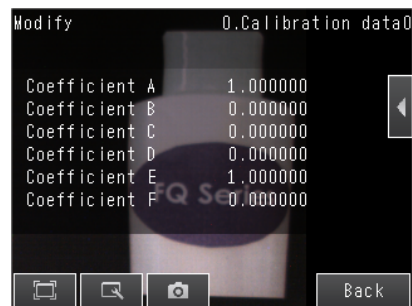

Selecting the Calibration Pattern to Use

In the Camera setup, select the calibration pattern to use.

Note

You can select the calibration pattern for each scene.

► [Image] – [Camera setup]

- 1 Press [**◀**] – [Calibration] on the right of the display.
- 2 Select the calibration pattern from [Calibration data 0] to [Calibration data 31].
- 3 Press [Back].

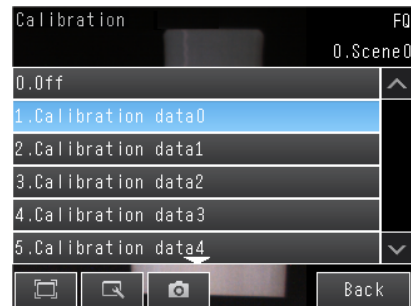

Note

If the selected calibration data has not been set yet, a message will be displayed asking if you want to go to the calibration setting display.

7-3 Display Functions

FQ2-S1

FQ2-S2

FQ2-S3

FQ2-S4

FQ2-CH

The procedures given in this section can be used to make the Sensor easier to use and the display easier to see.

Image Zoom

The display can be zoomed in or out to make the image easier to see.

▶ (Setup Mode or Run Mode)



Enlarges the display.

Reduces the display.

Fits the image to the display size.

Switches between live display and freeze display. (Only in Setup Mode)

Press [Back] to end setting the display.

Displaying a Live Image

You can display a live image to check the image that is input by the Sensor in realtime.

▶ (Setup Mode)

- 1 Press .
- 2 Press [Camera].
- 3 Press [Live].
- 4 Press the [Back] Button to return to the [Display] Display.



Note

This can also be set with the [Live] button () in the display settings display.

Displaying a Frozen Image

You can display a frozen image to stop image refreshing and display the last image that was input.

▶ (Setup Mode)

- 1 Press  .
- 2 Press [Camera].
- 3 Press [Freeze].
- 4 Press the [Back] Button to return to the [Display] Display.



Note

This can also be set with the [Freeze] button () in the display settings display.

Displaying a Saved Image

You can display an image that was saved in internal memory in the Sensor or in an SD card. This can be done to configure inspection items or to check measurements using saved images.

▶ (Setup Mode)

1 Press .

2 You can select one of the following types of images to display.

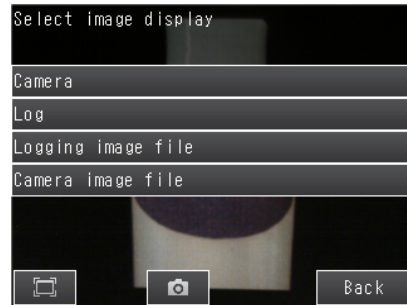

- [Log]: Images that are logged in the Sensor's internal memory
- [Logging image file]: Images that are logged in the SD card
- [Camera image file]: Images that were logged with  (Logging Button)

 *Saving the Currently Displayed Camera Image: p. 416*

3 Press the [Back] Button to return to the [Display] Display.

Note

Refer to the following information for the procedures to save images.

 *Logging Measurement Data: p. 392*

Updating the Display and Measurement Results Only for NG Measurement Results

In Run Mode, you can specify updating the display of the image and measurement results only when the measurement result is NG.

▶ (Run Mode)

- 1 Press .
- 2 Press [Last NG image].
- 3 Press [Back].

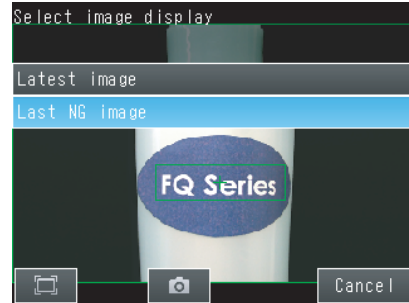

Change the following setting to display the last NG image after restarting.

▶ (Setup Mode or Run Mode) – [TF Settings] – [Startup display] – [Display update mode]

- 1 Press [Last NG image].

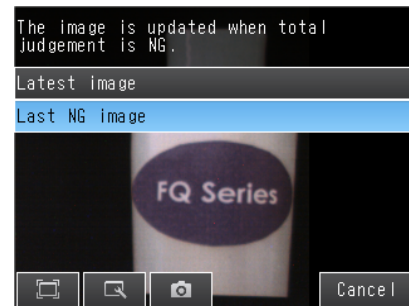

Note

If an operation to change the display is performed (e.g., if the display pattern is changed or the inspection item is changed) when displaying images for NG results is set, the display will change to refreshing the most recent measurement results and the most recent NG display will disappear.
To ensure that you can check the NG results, log the NG results.

 [Checking Recent Measurement Trends \(Recent Results Logging\): p. 401](#)

Automatically Changing to the Display for Any Sensor with an NG Result

You can change the settings to automatically display the Sensor for which the measurement result is NG if more than one Sensor is connected.

- ▶  (Run Mode) – [Sensor monitor] – [NG Sensor]

Hiding the Menu

To view an image that is hidden behind the menu, or to set a shape to full screen display, you can display only the image in the touch finder or on your computer.

If you press the icon again, the menu will be displayed.

- ▶  (Setup Mode or Run Mode)

Turning ON/OFF the Touch Finder Backlight

You can use Eco Mode to turn OFF the LCD backlight and reduce the power consumed by the Touch Finder whenever there is no operation on the Touch Finder for 30 seconds or longer. The LCD backlight will turn ON whenever any part of the touch panel is pressed.

- ▶  (Setup Mode or Run Mode) – [TF settings] – [LCD Backlight] – [ECO mode]

Changing the Brightness of the Touch Finder

The brightness of the LCD backlight can be changed to any of five levels.

- ▶  (Setup Mode or Run Mode) – [TF settings] – [LCD Backlight] – [Brightness]

7-4 Monitoring the Signal I/O Status

FQ2-S1

FQ2-S2

FQ2-S3

FQ2-S4

FQ2-CH

You can check if the I/O connections are working normally.

► [In/Out] – [I/O monitor] – [I/O monitor]

- 1 The I/O status of the external devices will be displayed.
- 2 Press the [OK] Button to return to the [Communication check] Display.

Input Signals (TRIG and IN0 to IN5)
Signals that are displayed in red are currently being input from the external devices to the Sensor.

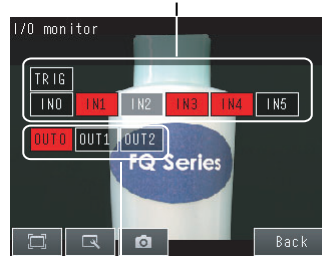

Output Signals (OUT0, OUT1, and OUT2)
Signals that are displayed in red are currently being output from the Sensor to the external devices.
You can turn the signals ON and OFF by pressing them to test the outputs.

Note

When the Sensor Data Unit is connected, the I/O status of the following signals are displayed.

FQ-SDU1□: TRIG, DSA, RST, IN0 to IN7,

RUN, OR, BUSY, ERR, STG, SHT, ACK, GATE, and D0 to D15

FQ-SDU2□: TRIG, RST, IN0 to IN5,

RUN, OR, BUSY, ERR, STG, SHT, and ACK

7-5 Connecting to More Than One Sensor

FQ2-S1

FQ2-S2

FQ2-S3

FQ2-S4

FQ2-CH

Up to eight sensors can be connected to one Touch Finder or a computer used for PC Tool. This sections describes how to connect more than one Sensor to a Touch Finder or computer.

Setting the Sensors to Connect

Use the following setting to connect more than one Sensor to a Touch Finder.

Automatically Connecting Sensors

The Touch Finder can detect Sensors and automatically connect to them in the order that it detects them. The Touch Finder can detect up to 32 Sensors and it can connect to up to eight Sensors at the same time. Set this parameter to [OFF] to connect to only a specific Sensor.

(Setup Mode or Run Mode) – [TF settings]

- 1 Set [Auto sensor detection] to [ON].

Note

If there are more than eight Sensors available for connection, use [Sensor List] to select the Sensors to connect.



Selecting the Sensors to Connect: p. 388

Registering the Sensors to Connect

You can set any of the Sensors for connection to the Touch Finder and register them.

▶ (Run Mode) – [Sensor List]

- 1 Press any line and then press [Add].

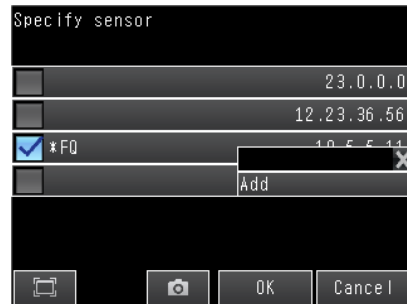

- 2 Enter the IP address.

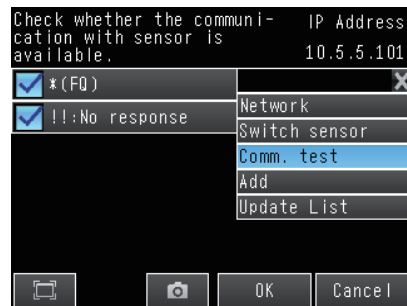

- 3 Press the IP address that you entered, and then press [Comm. test] to confirm that connection is possible.

Selecting the Sensors to Connect

You can select the Sensors to connect to the Touch Finder from a list.

► (Run Mode) – [Sensor List]

- 1 Press the check boxes of the Sensors to connect to select them.

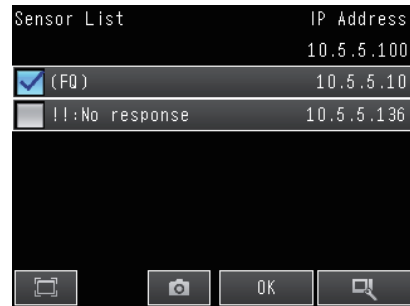

Note

- Sensors that are logged are indicated by "*" in before the sensor name.
- The names of Sensors that are on the same network as the Touch Finder are given in parentheses.
- If a sensor's IP address is abnormal, "!" will appear in front of the sensor name.
- "!!:No response" will appear in the sensor name of a sensor that is not responding.
- "!!:Unknown device" will appear if the device is not an FQ2 sensor.
- Automatically assigned IP addresses appear in gray.
- Manually set IP addresses appear in white.
- The IP address of the touch finder appears at the upper right.





Selecting the Display When More Than One Sensor Is Connected

Selecting the Display When More Than One Sensor Is Connected

You can select the display to appear on the Touch Finder when more than one Sensor is connected.

►  (Setup Mode or Run Mode) – [TF Settings] – [Startup display] – [Startup screen type]

1 Select one of the following display types.

Display type	Description
Multi Sensor	<p>Simultaneously displays the images from up to eight detected Sensors. The display positions for Sensors that are not connected will remain blank.</p> <p>The Sensors are connected in the order that they are detected. You can change the display positions of the Sensors.</p> <p> <i>Specifying Sensor Display Positions for Multiple Sensors ([Multi Sensor] or [Auto] Only): p. 390</i></p> <p>If there are more than eight Sensors that can be connected, select the Sensors to connect from the list of Sensors</p> <p> <i>Selecting the Sensors to Connect: p. 388</i></p> <p>Register the Sensor to connect to display a specific Sensor.</p> <p> <i>Registering the Sensors to Connect: p. 387</i></p>
NG sensor	Of the connected Sensors, displays the image from the Sensor that most recently had an NG result.
Single sensor	<p>Displays the image from only one Sensor. Of the Sensors, the image from only the Sensor that is specified in [Sensor selection] is displayed.</p> <p>If a Sensor is not specified in [Sensor selection], the image from the first Sensor that is detected will be displayed.</p> <p> <i>Specifying the Sensors to Connect Continuously: p. 417</i></p>
Auto (Default)	<p>Automatically adjusts the display according to the number of Sensors that are detected. If more than one Sensor is detected, the images from up to eight Sensors are displayed at the same time.</p> <p>If eight Sensors are connected, the display is the same as that for [Multi sensor].</p>

Specifying Sensor Display Positions for Multiple Sensors ([Multi Sensor] or [Auto] Only)

If [Startup screen type] is set to [Multi sensor] or [Auto],*1 you can specify the position of the image on a split display for each Sensor that is displayed.

*1 This can only be specified when at least two Sensors have been connected.

▶  (Run Mode) – [Sensor monitor] – [Multi sensor]

or

▶  (Run Mode) – [Switch sensor]

1 Press [] – [Display position] on the right of the display.

2 Press the display of the Sensor for which to specify the display position. A list of numbers for the display positions will be displayed.



3 Select a number from the list of display positions. The display for the Sensor will be displayed in the position that corresponds to the specified number.

Note

The display positions that are set with [Display position] are cleared when the power supply to the Touch Finder is turned OFF.

However, if the Sensor status is changed (by changing from Setup Mode to Run Mode), the current settings for [Display position] are saved in the Touch Finder. Therefore, the next time the same Sensors are connected, they will be displayed in the same positions.

If a previously connected Sensor is not detected, either the display position will be blank, or if [Auto sensor detection] is set to [ON], the Touch Finder will display another Sensor that it has detected.

If a previously connected Sensor is then detected by the Touch Finder, it will display the image from it in the previous display position.

Displaying information of individual sensors when multiple sensors are connected

The information of individual sensors can be displayed in the “Multi sensor” display and the “Switch sensor” display.

“OFF”, “IP address”, or “Sensor name” can be selected for the information that is displayed. The Default is “IP address”.

▶  (Run Mode) – [Sensor monitor] – [Multi sensor] or  (Run Mode) – [Switch sensor]

- 1 Press [◀] – [Setting disp. info.] at the right of the display.

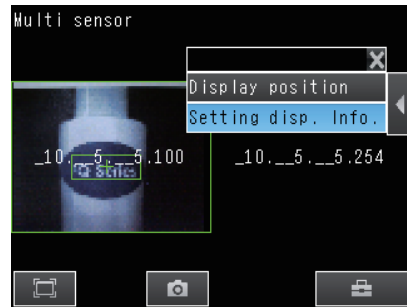

- 2 Press the connected sensor information you want to display.



7-6 Logging Measurement Data and Image Data

FQ2-S1

FQ2-S2

FQ2-S3

FQ2-S4

FQ2-CH

There are two ways to log data.

Recent results logging: Data is temporarily saved in memory inside the Sensor.

File logging: Large amounts of data are saved in SD cards or other external media.

The amounts and types of data that can be logged depend on the logging method that is used, as shown in the following table.

Logged data	Logged quantity	
	Recent results logging ^{*1}	File logging
Statistical data	One value (The average value of the measurement results in the collected measurement data is continuously updated.)	Not possible.
Measurement data	1,000 measurement values max. ^{*2}	Up to the capacity of the external memory
Image data	20 images max.	

*1: For recent results logging, the oldest data is overwritten when the maximum number of saved data items is exceeded.

*2: This limit is for one data item.

If more than one data item is logged at the same time, logging can be performed as long as the total number of data items in all logged data is 32,000 or less.

Logging Procedure

Use the following procedure to log data.

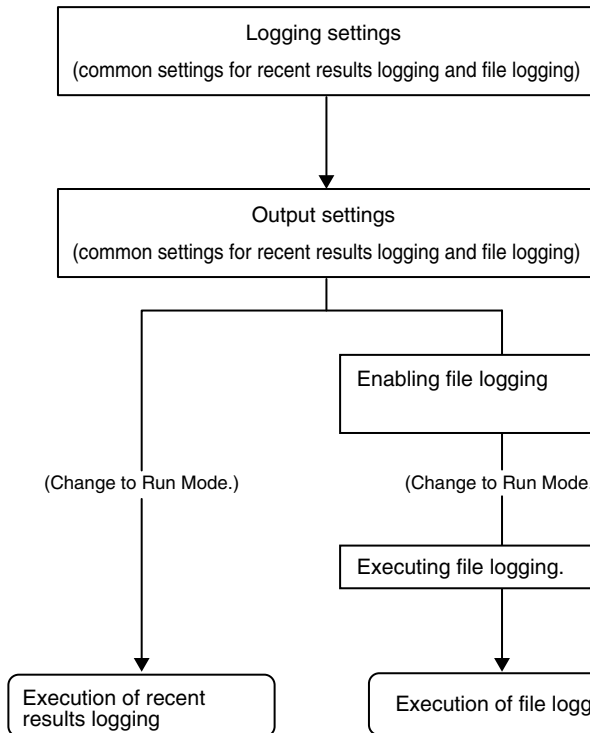

- Setting Logging Conditions
 - ☐ File logging: p. 394
 - Recent results logging: p. 401
- Selecting the Measurement Data To Log
 - ☐ p. 396
- Setting the File Name for Logged Data
 - ☐ p. 397
- Setting the Format for Saving Measurement Data
 - ☐ p. 399
- Enabling File Logging
 - ☐ p. 399
- Starting and Stopping Logging
 - ☐ p. 399

- Saving Recent Results Logging Data
 - ☐ p. 403
- Deleting Logged Data
 - ☐ p. 403

Logging All Data (File Logging)

Large amounts of measurement and image data can be saved in files in external memory (SD cards or computer).

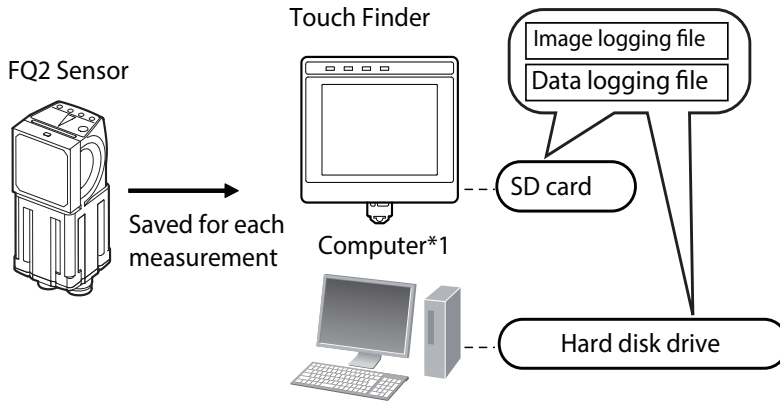

*1: Image data and measurement data can be logged in the same way as for the Touch Finder by installing the PC Tool for FQ.

 *System Configuration: p. 32*

Note

Only the data for the Sensor that is currently being displayed will be logged even if more than one Sensor is connected.

If multiple sensors are displayed, or if the most recent NG sensor is displayed, only the results of the sensor that was displayed before changing to the other sensor monitor screen will continue to be logged. Simultaneous logging of the results of multiple sensors is not possible.

Setting Logging Conditions

Use the following procedures to set the conditions to log data.

► [In/Out] – [Log setting]

• Image Data

- 1 Press [Image logging].
- 2 Change the logging conditions, and then press [Back].

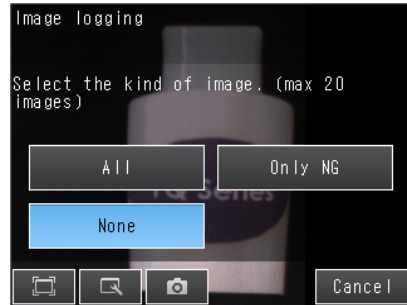

• Measurement Data

- 1 Press [Data logging] – [Condition].
- 2 Change the logging conditions, and then press [Back].

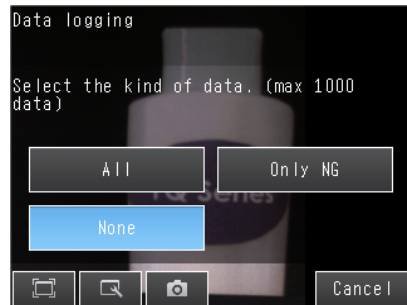

Item	Description
Image logging (image data)	All: All images will be logged regardless of the measurement results. Only NG: Only images for which the overall judgment was NG will be logged. None: No images will be logged (Default).
Data logging (measurement data)	All: All measurement data (Measured values and calculation results) will be logged regardless of the measurement results. Only NG: Only measurement data (Measured values and calculation results) for which the overall judgment was NG will be logged. None: No measurement data (Measured values and calculation results) will be logged (Default).

Note

The logging parameter settings are the same for recent results logging.

Selecting the Measurement Data To Log

Use the following procedure to select the measurement data to log.

► [In/Out] – [Log setting] – [Measurement data] – [Select data]

- 1 Press the measurement pre-processing, inspection item, or calculation that has the parameter to be logged.

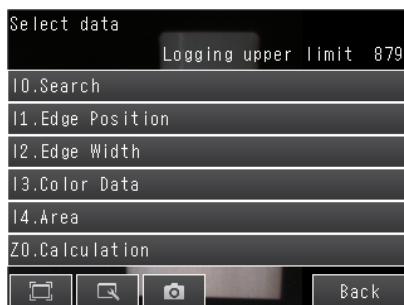

- 2 Press the parameter for which to log data to select it.

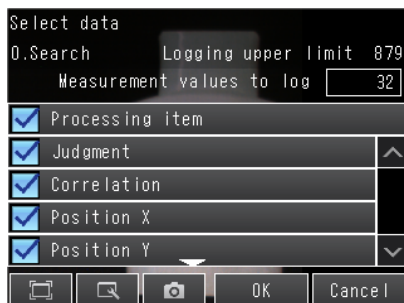

Note

The procedure to select the measurement data to log is the same for recent results logging.

Storage Locations and File Names for Logged File Data

Data	Storage location		File name
	TouchFinder	TouchFinder for PC	
Image logging (image data)	\sensor_name\ LOGIMAGE\number* ¹	\My Documents\OMRON FQ\SDCard\Sensor name\LOGIMAGE\	img_Scnxxx_YYYY_MM_DD-HH_MM_SS(n)_ <i>MeasurementID_OverallJudgementResult</i> .IFZ* ^{3,4,5} Example: The following name would be used for mea- surements performed at 10:10:21 pm on May 10, 2012 when Scene1 is set, and it's measurement result is OK. Then Image logging (image data) is as below. img_Scn001_2012_05_10- 22_10_21(0)_0000_OK.IFZ.IFZ
Data logging (measurement data)	\sensor_name\LOG- DATA	\My Docu- ments\OMRON FQ\SDCard\Sensor name\LOGDATA	YYYY_MM_DD-HH_MM_SS.CSV* ⁶ Example: The following name would be used for mea- surements performed at 10:10:21 pm on May 10 2012: 2012_05_10-22_10_21.CSV

- *1: A five-digit number is assigned as a name to the image data storage folder in the order of folder creation as shown below.
 Up to 100 images are stored in each folder.
 00000
 00001
 :
 :
 :
- *2: Files are stored in the following folder when the PC Tool is used.
 \My Documents\OMRON FQ\SDCard
- *3: "n" is a serial number that is added when images are logged at the same time.
- *4: You can change the "img" at the beginning of the file name.
- *5: You can add a character string to the beginning of the file name.
- *6: Measurement ID is a value equal to the measurement count minus 1.
 When launching the FQ2, the count starts from zero.

Note

- TouchFinder file save capacity is limited by capacity of SD card.
- TouchFinder for PC's file save capacity is limited by capacity of your PC's hard disk.

- Setting the File Name for Logged Data

You can set a character string to add to the beginning of the file name for logged data.

Image data: You can change the "img_" at the beginning of the file name for logged data to another text string.

Measurement data: You can add a character string to the beginning of the file name for logged data.

▶ (Setup Mode or Run Mode) – [TF settings] – [File format]

- 1** Select the item for which to add to or change the file name and then press [Logging image file] or [Logging data file].
- 2** Press [File name prefix].
- 3** Enter the file name (up to 15 alphanumeric characters) and press [OK].
- 4** Press [OK].

File Format

Image data: Image data is saved in a special format for OMRON Sensors.

(The file name extension is IFZ.)

Measurement data: Measurement data is saved in the following CSV format.

Data	Time	Measurement ID	Scene No.	Judge	ID.CR0	ID.X0	...	ID.CR1	...	I1.Diff	Zn.D00	...
yyyy mm dd	hh mm ss	100	0	0	85	152		79		578	58	
yyyy mm dd	hh mm ss	150	0	-1	88	155		82		581	61	

1) 2) 3) 4) 5) 6) 7)

Item	Format	Description
1)	Date ^{*1}	YYYY/MM/DD This is the date that the measurement data was obtained from the Sensor. ^{*1}
2)	Time ^{*1}	hh:mm:ss This is the time that the measurement data was obtained from the Sensor.
3)	Measurement ID	--- This is the measurement ID information. ^{*2}
4)	Scene No.	--- Scene number
5)	Judge	--- Overall judgment 0: OK, -1: NG, -2: NC (not measured)
6)	Inspection item region	I(inspection_item_number).(measurement_item)(detection_point) Example 1: The correlation of the second detection point in a search for inspection item number 0 would be given as follows: I0.CR2 Example 2: The judgement result of OCR of inspection item No. 0 would be given as follows: I0.JG The data selected for logging in the [Measurement data] under [Log setting] is output. If multiple results are detected, only the maximum number of data items that is set in the [Measurement data] are output.
7)	Expression region	Zn.J**,Zn.D** Example: The fourth registered expression would be: Z0.J04,Z0.D04 (FQ2-S1) The judgement result and calculation result of each expression are output. ** indicates 00 to 31. Zn (expression variable): Z0 for FQ2-S1/S2/S3, Z1 for FQ2-S4/CH.

*1: The data and time are not recorded with the measurement data. Therefore, this is not the date that the measurement was executed. This is the date that the PC Tool or the Touch Finder obtained the data from the Sensor.

*2: Measurement ID is a value equal to the measurement count minus 1.
When launching the FQ2, the count starts from zero.

Changing the Format for Saving Measurement Data

The output CSV file format can be changed according to the external device.

▶  (Setup Mode or Run Mode) – [TF settings] – [File format] – [Logging data file]

- 1 Press [Output format].
- 2 Change the required items in the CSV format.
- 3 Press [Back].

Item	Symbol
Field separator	None, comma (Default), tabs, space, colon, semicolon, CR, or CR+LF
Decimal symbol	None, point (Default), or comma
Record separator	None, comma, tabs, space, colon, semicolon, CR, or CR+LF (Default)

Enabling File Logging

You must enable file logging before you can execute it.

▶  (Setup Mode) – [TF settings] – [Logging setting]

- 1 Press [ON].

Starting and Stopping Logging

After logging is started (i.e., set to ON), the specified image data and measurement data will be saved in the SD card or computer hard disk each time measurements are performed.

▶  (Run Mode)

- 1 Press [Logging].
- 2 Press [Image logging] or [Data logging].
- 3 Press [ON] to start logging.
Press [OFF] to stop logging.
- 4 Press [Back].

Note

To save logged data, you must first select either [All] (all data is saved) or [Only NG] (only NG data is saved) in the logging parameters.

 Setting Logging Conditions: p. 395

Ensuring That All Measurement Results Are Logged in External Memory

To ensure that all measurement results are actually saved, change the settings so that the BUSY signal remains ON until logging has been completed. During operation, do not input the next trigger until the BUSY signal turns OFF.

► [In/Out] – [I/O setting] – [I/O terminals] – [Output] Tab Page – [BUSY output]

Change the BUSY output parameter to [Data logging].

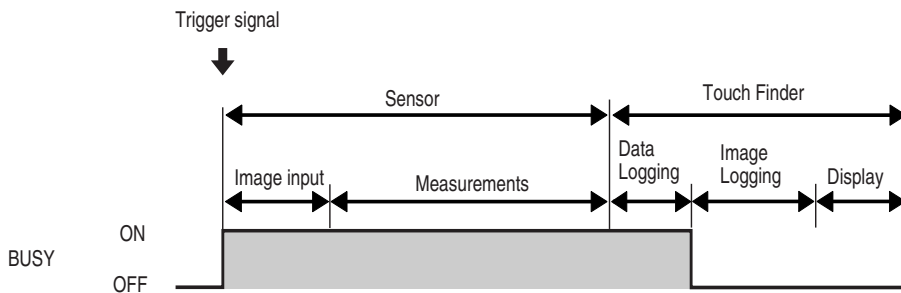

Note

- File logging cannot be used when performing continuous measurements.
- If you use the PC Tool, the logging time may vary by up to 100 ms depending on the application conditions of your computer.
- If logging data to an SD card, the write time varies depending on the amount of the available space on the SD card.
Reference value: For SDHC class 4, the time required to write image data is approx. 200 to 800 ms.

Checking Recent Measurement Trends (Recent Results Logging)

The most recent measurement results can be logged inside the Sensor.

Even if data is not logged in external memory, such as an SD card, trends in measurement results can be easily checked on the Touch Finder.

However, if the power supply is turned OFF, this data will be lost.

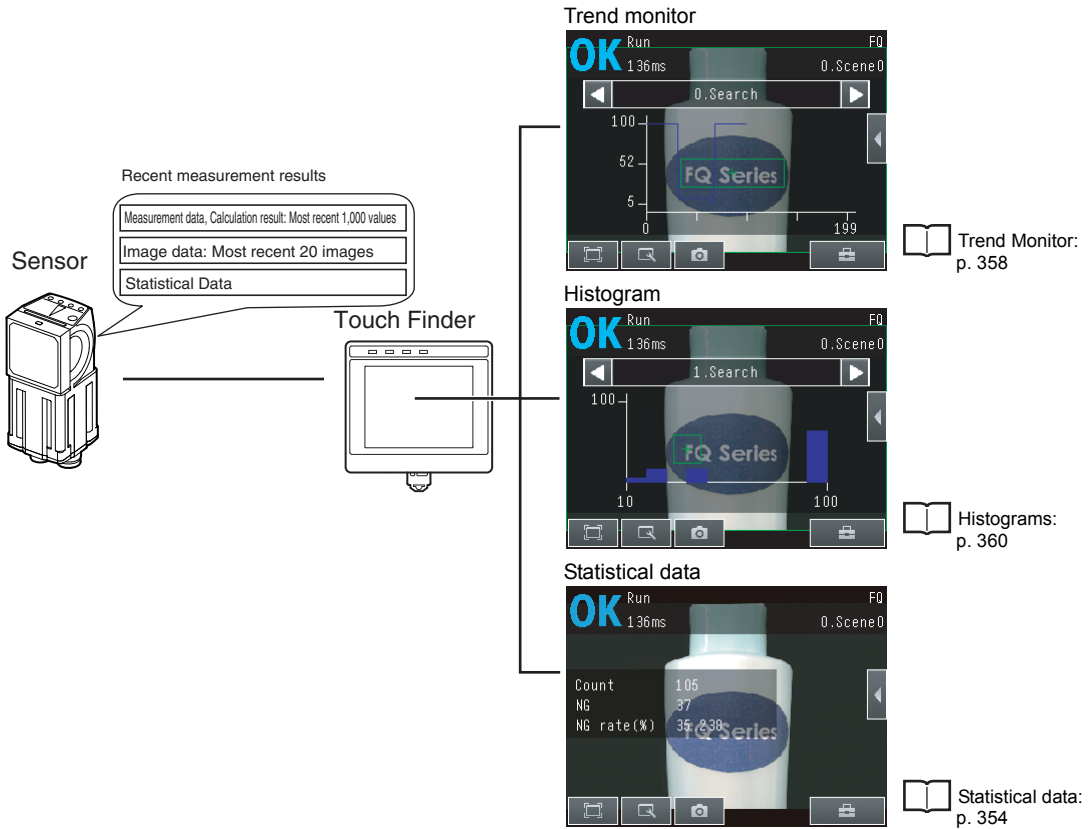

Setting Logging Conditions

Use the following procedure to set the conditions for the measurement data, image data, and statistical data that will be logged.

Some of these operations and settings are the same as for file logging.

 *Setting Logging Conditions: p. 395*

Item	Description
Statistical data	Statistical data, such as the number of measurements, the number of NG overall judgments, and the NG rate, since the power supply was turned ON will be logged. ON : Statistical data will be displayed (Default). OFF: Statistical data will not be displayed.
Logging image (image data)	These are the same as for file logging.
Logging data (measurement data)	

Note

The logging parameters for image data and measurement data are the same as those for file logging.

Selecting the Measurement Data To Log

With recent results logging, you can select the measurement pre-processing, measurement data, or calculation items to be logged. These settings also apply to file logging.

 *Selecting the Measurement Data To Log: p. 396*

Starting Logging

Logging will be started as soon as the conditions for logging have been set.

If the settings are saved, logging will start automatically the next time the power supply is turned ON.

Checking the Results of Logging

The results of logging can be checked using the trend monitors, histograms, or statistical data.

 6-2 *Configuring the Run Mode Display: p. 354*

Use the following menu command to check the image data.

▶  (Setup Mode) –  – [Log]

Deleting Logged Data

The logged data will be deleted when the power supply to the Sensor is turned OFF. The logged data can also be deleted without turning OFF the power supply.

• Setup Mode

▶ [In/Out] – [Log setting]

1 Press [Delete Log].

Saving Logged Recent Results Data in a File

Although the logged recent results data will be deleted when the power supply is turned OFF, it can be saved in a file in external memory.

The most recent 1,000 measurement values and the most recent 20 images at the time save is executed will be saved in the file. (When the logging data number is one. When more than one, logging can be performed until the total number of values of all logging data is 32,000.)

▶  (Setup Mode) – [Save to file] – [Logging] Tab Page

1 Press the data to save.

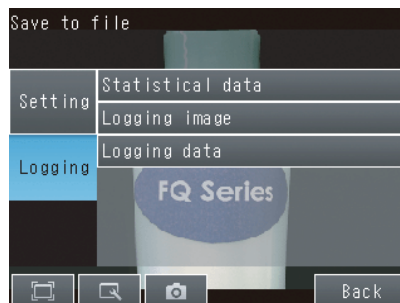

2 The following display will appear if [Logging image] is pressed.



Select whether to save the most recently logged image or to save all of the image data that is logged in the Sensor.

The file storage locations and file format are given in the following table.

Item	Storage location	File name
Statistical data	\sensor_name\LOGDATA* ¹	YYYY_MM_DD-HH_MM_SS_record.CSV* ²
Logging data (measurement data)		Example: The following name would be used for measurements performed at 10:10:21 pm on May 10, 2012: 2012_05_10-22_10_21_record.CSV
Logging image (image data)	\sensor_name\LOGIMAGE* ¹	img_Scn0**_YYYY_MM_DD-HH_MM_SS(n)_MeasurementID_OverallJudgementResult.IFZ* ^{3*4*5} Example: The following name would be used for measurements performed at 10:10:21 pm on May 10, 2012: img_2012_05_10-22_10_21(0)_0000_OK.IFZ

*1: Files are stored in the following folder when the PC Tool is used.
 \My Documents\OMRON FQ\SDCard

*2: You can add a character string to the beginning of the file name.

*3: "n" is a serial number that is added when images are logged at the same time.

*4: You can change the "img" at the beginning of the file name.

*5: You can add a character string to the beginning of the file name.

*6: Measurement ID is a value equal to the measurement count minus 1. When launching the FQ2, the count starts from zero.

• File format

Statistical data : The data is saved in the following CSV format.

Image data : Number of measurements, number of OKs, number of NGs, OK rate, NG rate (delimiter)
 Image data is saved in a special format for OMRON Sensors.
 (The file name extension is IFZ.)

Measurement data : Measurement data is saved in CSV format.

Index	Measurement	Scene No.	Judge	10. CR1	10. X0	11. JG	Zn. J00	Zn. D00
1	0	0	0	85	152	0	0	58
2	1	0	-1	88	155	0	0	61
3	2	0	-1	88	155	0	0	61
1)	2)	3)	4)	5)		6)		

Item	Format	Content
1)	Index	—
2)	Measurement ID	—
3)	Scene No.	—
4)	Judge	—
5)	Inspection item region	Inspection item No., Measurement item, Inspection point Example 1 When Search is executed with inspection item No.0, the second correlation value is I0, CR1. Example 2 Judgment result in OCR of inspection item No.1 is I1, JG
6)	Arithmetic expression region	Example Arithmetic expression judgment registered the fist: Z0.J00,Z0.D00?FQ2-S1?

*1 Measurement ID is calculated -1 from measurement counts. This ID is counted from zero at launch of FQ2.

Note

- The saved recent measurement data cannot be loaded back into the Sensor and displayed on a trend monitor or histogram.
- The data and time are not recorded with the measurement data.
The file name is created from the time when the file is saved. It does not indicate when the measurement was made.

Important

The recent log data will be cleared if the scene is changed.

Changing the Format for Saving Measurement Data

The output CSV file format can be changed according to the external device.

 *Changing the Format for Saving Measurement Data: p. 399*

Displaying Image Data

• Images Saved in Internal Sensor Memory

▶  (Setup Mode) –  – [Log]

• Image Files in an SD Card

▶  (Setup Mode) –  – [Logging image file] or [Camera image file]

 *Displaying a Saved Image: p. 382*

7-7 Saving Sensor Settings

FQ2-S1

FQ2-S2

FQ2-S3

FQ2-S4

FQ2-CH

The Sensor settings are saved in flash memory inside the Sensor.

This section describes how to back up the settings in and restore them from an SD card or other external memory.

Backing Up Settings in External Memory

▶  (Setup Mode) – [Save to file] – [Setting] Tab Page

1 Press the data to save.

2 Enter the file name in 15 characters or less.

After entering the file name, press [OK]. The data will be saved and the display will return to [Save to file].

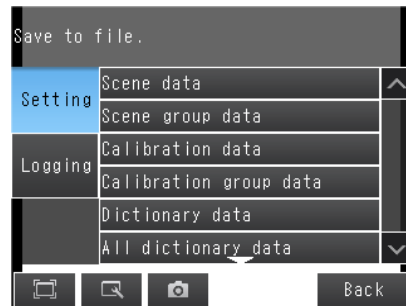

Applicable Data

Data	Storage location ^{*1}	Description
Scene data (The file name extension is SCN.)	\sensor_name\SCN	The following data are backed up for each scene. Settings for all inspection items Order of inspection items
Scene group data ^{*2} (The file name extension is SGP.)	\sensor_name\SGP	All scene data are backed up.
Calibration data (file name extension: CLB)	\sensor_name\CLB	The calibration data are backed up.
Calibration group data (file name extension: CGP)	\sensor_name\CGP	All calibration data are backed up.
Dictionary data ^{*2} (The file name extension is DIC.)	\sensor_name\DIC	Dictionary data are backed up.
All dictionary data (The file name extension is DGP.)	\sensor_name\DGP	All dictionary data are backed up.
Code data ^{*2} (file name extension: .csv)	\sensor_name\CODE	Code data will be backed up.
Sensor system data (The file name extension is SYD.)	\sensor_name\SYD	All system data in the Sensor are backed up. The system data are the same for all scenes.
All Sensor data (The file name extension is BKD.)	\sensor_name\BKD	All settings in the Sensor (scene group data, Sensor system data, calibration group data, and all dictionary data ^{*2}) are backed up.
Touch Finder data (The file name extension is MSD.)	MSD	All settings in the Touch Finder are backed up.

*1: For the PC Tool, data will be saved in the following folder: \\.\My Documents\OMRON FQ\SDCard\

*2: Only supported on the FQ2-S4/CH Series.

Restoring Data to the Sensor from External Memory

▶  (Setup Mode) – [Load from file]

1 Press the data to be restored.

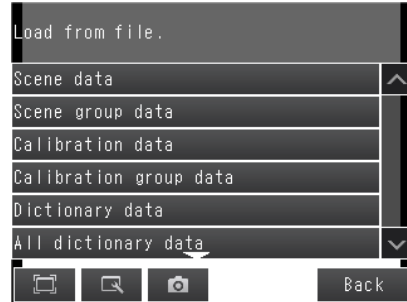

2 The selected data will be read from external memory and displayed. Press the file to load.



7-8 SD Card Operations

FQ2-S1

FQ2-S2

FQ2-S3

FQ2-S4

FQ2-CH

With an FQ2 Sensor, the following folders are automatically created in the SD card according to the data that is saved. The specified data is saved in files in these folders.

Storage folder ^{*1}	Data
\\sensor_name\\SCN	Scene data (The file name extension is SCN.)
\\sensor_name\\SGP	Scene group data (The file name extension is SGP.)
\\sensor_name\\DIC ^{*2}	Dictionary data (The file name extension is DIC.)
\\sensor_name\\DGP ^{*2}	All dictionary data (The file name extension is DGP.)
\\sensor_name\\CODE ^{*2}	All dictionary data (The file name extension is CSV.)
\\sensor_name\\SYD	Sensor system data (The file name extension is SYD.)
\\sensor_name\\BKD	All sensor data (The file name extension is BKD.)
\\sensor_name\\CLB	Calibration data (The file name extension is CLB.)
\\sensor_name\\CGP	Calibration data (The file name extension is CGP.)
\\MSD	Touch Finder data (The file name extension is MSD.)
\\sensor_name\\LOGIMAGE	Image data (The file name extension is IFZ.)
\\sensor_name\\LOGDATA	Statistical data and measurement data (The file name extension is CSV.)
\\CAPTURE	Captured images (The file name extension is BMP.) Camera image data (The file name extension is IFZ.)

*1 : For the PC Tool, data will be saved in the following folder: \\.\My Documents\OMRON FQ\SDCard\

*2 : Only supported on the FQ2-S4/CH Series.

Note

- The PC Tool does not support SD card operations.
- To display an image file saved in an SD card, refer to the following.
- Use SD card formatted as FAT or FAT32. Touch Finder will not recognize other formats.

▶  (Setup Mode) –  – [Logging image file] or [Camera image file]

 *Display Functions - Displaying a Saved Image: p. 382*

Inserting and Removing SD Cards

Inserting an SD Card in the Touch Finder

- 1** Open the cover to the SD card slot on the top of the Touch Finder.

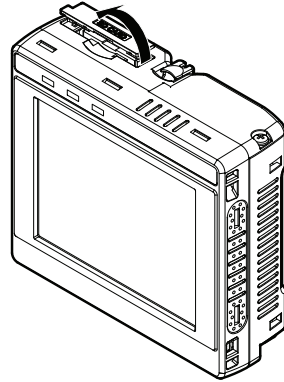

- 2** Insert the SD card with the back of the SD card facing the front of the Touch Finder and press it in until it clicks into place.

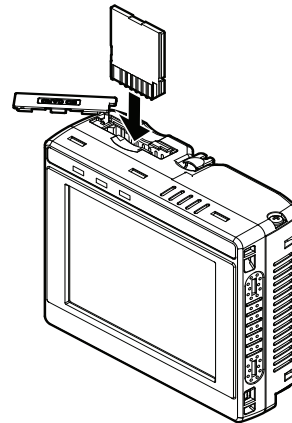

- 3** Close the cover to the SD card slot.

Removing an SD Card from the Touch Finder

- 1 Open the cover to the SD card slot on the top of the Touch Finder.
- 2 Press in on the SD card until you hear a click.
- 3 Pull out the SD card.
- 4 Close the cover to the SD card slot.

- Never remove the SD card while data is being saved or read. The data on the SD card may be corrupted.

Important

Do not restart or turn OFF the power supply to the Sensor or Touch Finder while a message is being displayed saying that data is being saved to or read from the SD card. The settings or system data may be corrupted.

Checking the Available Space on the SD Card

Before saving data to the SD card, use the following display to make sure that there is sufficient space available on the SD card.

- ▶  (Setup Mode or Run Mode) – [TF settings] – [SD card] – [SD card information]

- 1 The following information in the SD card inserted in the Touch Finder can be checked.



Formatting an SD Card

▶  (Setup Mode or Run Mode) – [TF settings] – [SD card] – [Format]

1 Press [Yes] to start formatting.

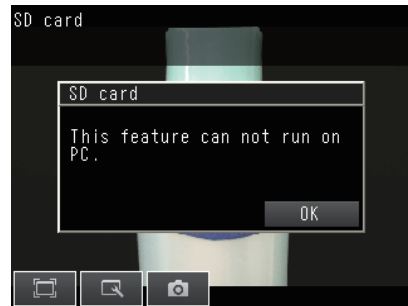

7-9 Convenient Functions for Operation

FQ2-S1

FQ2-S2

FQ2-S3

FQ2-S4

FQ2-CH

This section describes the functions that can be used during Sensor operation.

Setting a Password to Prevent Unwanted Changes

A password can be set to prevent unwanted changes to settings.

If a password is set, you cannot change from Run Mode to Setup Mode without entering the password.

Setting a Password

▶  (Setup Mode) – [Sensor settings] – [Password settings]

- 1 Press [Password on/off] and press [ON].
- 2 Press [Enter password].
- 3 Enter a password containing up to 15 characters and press [OK].

Clearing the Password

▶  (Setup Mode) – [Sensor settings] – [Password settings]

Press [Password on/off] and press [OFF].

Entering the password when switching from [Run] Mode to [Setup] Mode.

- 1 If a password is set and you try to change from Run Mode to Setup Mode, the following password entry display will appear.

- 2  (Setup Mode) – [Sensor settings]

- 3 Press the text box. A keyboard display will appear. Enter the password and press [OK]. If the password is correct, the Setup Mode will be displayed.

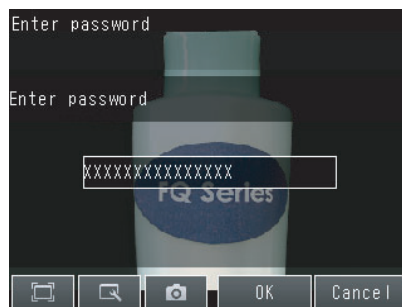

Important

- This password restricts only the operation to switch from Run Mode to Setup Mode. It does not restrict other operations.
- If you forget the password, contact your OMRON representative for the procedure to clear the password.
- The password is deleted when the Sensor is initialized.

Capturing the Displayed Image

The current display on the Touch Finder or PC Tool can be captured and used in text files and other files on the computer.

The captured images are saved in external memory*1 as bit maps.

*1: Images captured on the Touch Finder are saved in the SD card. Images captured with the PC Tool are saved in the computer's hard disk drive.

▶ (Setup Mode or Run Mode)

The image that is being displayed when the button is pressed is saved in external memory.

• Storage Location and File Names

Storage location	File name
\\CAPTURE	YYYY_MM_DD-HH_MM_SS.BMP Example: The following name would be used for an image that was captured at 10:10:21.350 pm on March 10, 2010. 2010_03_10-22_10_21_350.BMP

Important

Make sure an SD card is inserted in the Touch Finder before capturing display images.

Note

For the PC Tool, data will be saved in the following folder: \\.\My Documents\OMRON FQ\SDCard\

Saving the Currently Displayed Camera Image

You can save the Camera image that is displayed on the Touch Finder or computer.

▶  (Setup Mode) –  –  (Log Image Button)

The Camera image that is being displayed when the  Button is pressed is saved in external memory.

• Storage Location and File Names

Storage location	File name
\\CAPTURE	YYYY_MM_DD-HH_MM_SS.IFZ Example: The following name would be used for an image that was captured at 10:10:21.350 pm on March 10, 2010: 2010_03_10-22_10_21_350.IFZ

Important

Make sure an SD card is inserted in the Touch Finder before capturing display images.

Note

For the PC Tool, data will be saved in the following folder: \\.\My Documents\OMRON FQ\SDCard\

Setting the Startup Run Display Pattern

You can select the startup run display pattern. This only appears when [Start screen type] under [Startup display] is set to [Single sensor].

▶  (Setup Mode or Run Mode) – [TF settings] – [Startup display] – [Display pattern]

- 1 Select from the following: [Graphics], [Graphics + Details], [Statistical data], [All results/region], [Trend monitor], or [Histogram].

Note

The Default display setting for startup can be changed.

 *Selecting the Display When More Than One Sensor Is Connected: p. 389*

Specifying the Sensors to Connect Continuously

You can specify one Sensor to connect to the Touch Finder.
The Touch Finder will connect to that Sensor each time the Touch Finder is started.

▶  (Setup Mode or Run Mode) – [TF settings] – [Startup display]

- 1 Set [Specify sensor] to [ON].
- 2 Set [Sensor selection] to the IP address of the Sensor.

Note

If the Touch Finder cannot connect to the specified Sensor when the Touch Finder is started, it will continue to retry until a connection is made.

If connection to the specified Sensor is not possible, press the [Sensor List] Button to cancel connecting to the specified Sensor.

Monitoring and Setting Up a Sensor from Two Touch Finders

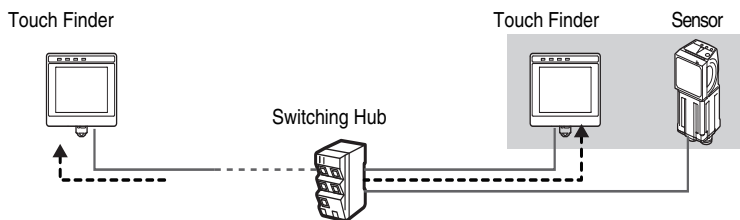

You can monitor and set up the same Sensor from two Touch Finders.
You can simultaneously monitor the Sensor from both Touch Finders.
You can set up the Sensor only from one of the two Touch Finders at any one time.



You can monitor the same Sensor at the same time from a locally installed Touch Finder and a remotely installed Touch Finder.

Operations during Simultaneous Connection of Two Touch Finders

The following restrictions apply to operations when two Touch Finders are simultaneously connected to the same Sensor.

Operation	Sensor status	Changes
Editing model regions in Run Mode	Monitor	Operation is possible with only one of the Touch Finders. Operation will be possible from the Touch Finder where [Model region] was pressed first.
Run Mode operations	Setup	<p>When either of the Touch Finders changes to Setup Mode, operation will no longer be possible from the other Touch Finder.</p> <p>When that occurs, a message will be displayed on the other Touch Finder saying that another Touch Finder is currently setting up the Sensor.</p> <p>A  (Switch sensor) icon will be displayed on the lower right of the display.</p> <p>When Run Mode operations are possible again, Run Mode will be displayed in the initial status.</p>
Logging	Monitoring or setup	<p>Logging (including file logging and recent results logging) can be performed by only one of the Touch Finders.</p> <p>If logging is enabled on both of the Touch Finders, logging will be performed only on the Touch Finder that was connected to the Sensor first.</p> <p>An error will be displayed on the other Touch Finder when it connects to the Sensor and logging will automatically be disabled.</p> <p>If logging is disabled on both of the Touch Finders when they are connected, logging will be performed only on the Touch Finder for which logging is enabled first.</p> <p>You can use the following parameter to enable and disable logging.</p> <p> <i>Enabling File Logging: p. 399</i></p>
Trend monitors and histograms	Monitoring or setup	Trend monitors and histograms can be displayed only if logging is enabled. Therefore, they can be displayed only on the Touch Finder for which logging is enabled as described above.

Checking the cause of a sensor NG from the multisensor display

It is easy to check the cause of a sensor NG when multiple sensors are connected.

You can immediately move between the detailed result display of a sensor, the multi-sensor display, and the result list display.

▶ (Setup Mode) – [TF settings]

1 Press the [Multi sensor button] in [Display setting in Run mode].

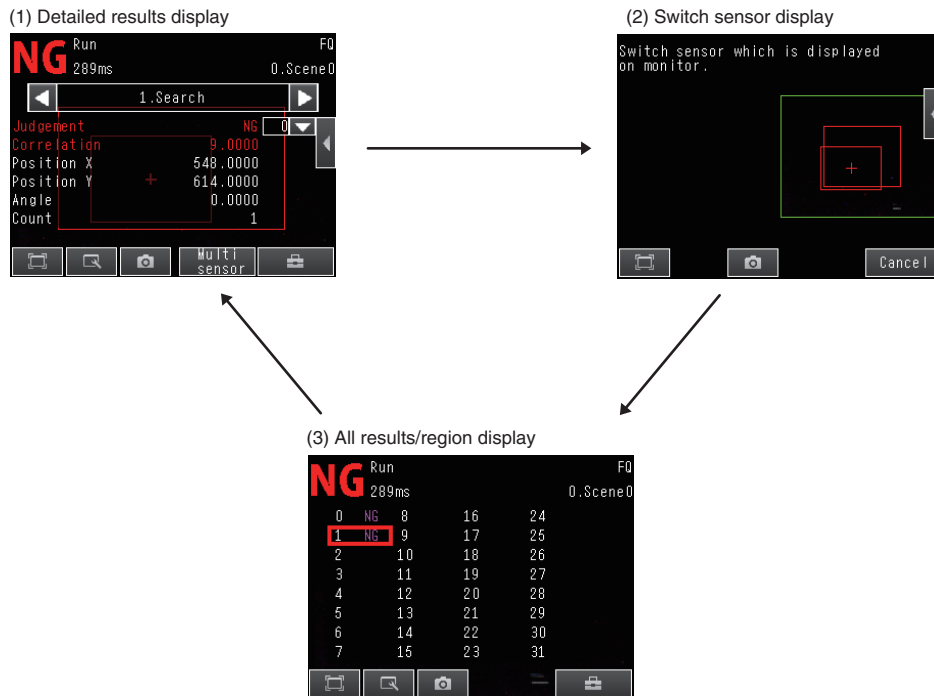

(1) Press [Multi sensor] in the detailed results display to move to the Switch sensor display.

(2) In the switch sensor display, press the sensor whose results you want to check. The result list display of that sensor appears.

(3) In the result list display, press the inspection item for which the NG occurred. The detailed results display of the selected inspection item appears.

7-10 Convenient Functions for Setup

FQ2-S1

FQ2-S2

FQ2-S3

FQ2-S4

FQ2-CH

This section describes the functions that can be used when setting inspection items.

Making Settings with Stored Images

With an FQ2 Sensor, judgment parameters can be set by using the following images.

- Images saved in internal Sensor memory.
- Image files in an SD card

Note

You can also use images that were captured on the display.

 *Capturing the Displayed Image: p. 415*

Saving Image Data

• Temporarily Saving Images in the Sensor

The measured images can be temporarily saved inside the Sensor. These images are held until the Sensor power supply is turned OFF.

▶ [In/Out] – [Log setting] – [Image logging]



 *Setting Logging Parameters for Image Data: p. 401*

• Saving Images in the Sensor to an SD Card

The images that are temporarily saved inside the Sensor can be saved to an SD card.

▶ (Setup Mode) – [Save to file] – [Logging] Tab Page

- 1 Press [Logging image].
- 2 Select whether to save the most recently logged image or to save all of the data that is logged in the Sensor.

Storage location	File name
\sensor_name\LOGIMAGE	 <code>Img_Scn0**_YYYY_MM_DD-HH_MM_SS(n)_MeasurementID_OverallJudgementResult.IFZ*</code> Example: The following name would be used for files saved at 10:10:21 pm on March 10, 2010.  <code>Img_Scn000_2010_03_10-22_10_21(0)_0000_OK.IFZ</code>

* Measurement ID is a value equal to the measurement count minus 1. When launching the FQ2, the count starts from zero.

• Saving Images in an SD Card

The image data can be saved in the SD card each time measurements are performed.

▶ (Run Mode) – [Logging]

 *Logging All Data (File Logging): p. 394*

You can also save the data in Setup Mode by using  (Display Arrangement) –  (Log Image Button).

Displaying Image Data

• Images Saved in Internal Sensor Memory

▶ (Setup Mode) – – [Log]

• Image Files in a SD Card

▶ (Setup Mode) – – [Logging image file] or [Camera image file]

 *Display Functions - Displaying a Saved Image: p. 382*

7-11 Setting the Retry Function

FQ2-S4

FQ2-CH

Retry Function

This function repeats the Scan (with a single measurement trigger) until the overall judgment is OK.

The retry function has four modes: normal retry, exposure retry (*1), scene retry, and trigger retry.

*1: The brightness (exposure) depends on the shutter speed and gain. When HDR is ON, the shutter speed and gain are automatically adjusted for the optimum exposure. When HDR is OFF, the gain is fixed.

▶  (Setup Mode) – [Sensor settings] – [Retry details] – [Retry mode]

1 Select the retry mode.



Retry mode	Description
Normal retry	This function repeats the Scan at the specified interval and count until the overall judgment is OK. Sets the repeat count and imaging interval. These settings are set from Retry settings of each Scenes.
Exposure retry	Scanning is repeated the specified number of times while varying the exposure (when HDR is OFF, the shutter speed is varied) until the entire code is successfully scanned. The brightness step (shutter speed step when HDR is OFF), increment count, and decrement count are specified. The settings are configured in the retry settings of each scene.
Scene retry	This function repeats the scan at the specified count while switching the Scenes until the overall judgment is OK. [Auto] or [Fixed] is selected for the switch order. [Auto]: Switches through the scenes in the order of highest frequency of use. [Fixed]: Switches scenes in the set order.
Trigger retry	This function repeats the reading procedure until the overall judgment is OK when IN5 signal of parallel is ON. To use trigger retry, the I/O input mode must be set to expanded mode.
None (Default)	Retry is not performed.

Combining retry modes

Normal retry, exposure (shutter speed) retry, scene retry, and trigger retry cannot be used at the same time. When scene retry is ON, the normal retry and exposure retry modes in the same scene are OFF. When normal retry, exposure retry, or scene retry is ON, trigger retry is OFF.

Setting normal retry

- Set the retry mode to [Normal retry] in "Retry details".

▶  (Setup Mode) – [Sensor settings] – [Retry details]

- 1 Press [Normal retry] for the retry mode.
- 2 Press OK.

- Specify the maximum count and interval.

▶ [Inspect] – [Retry details]

- 1 Set the maximum count and interval.



Parameter	Settings	Description
Max count	0 to 20, (Default: 4)	Sets the maximum number of retries.
Interval	32 to 999 (Default: 100)	Sets the capture interval (msec).

Setting exposure retry

- Set the retry mode to [Exposure retry] in "Retry details".

▶  (Setup Mode) – [Sensor settings] – [Retry details]

1 Press [Exposure retry] for the retry mode.

- Set the brightness (shutter speed) step, increment count, and decrement count.

▶ [Inspect] – [Retry details]

1 Set the brightness (shutter speed) step, increment count, and decrement count.



Parameter	Settings	Description
Brightness (shutter speed) step	Brightness: 1 to 20 (Default: 5) Shutter speed: 0.01 to 1.00 (Default: 0.30)	Sets the brightness or shutter speed step (msec).
Increment count	0 to 10 (Default: 2)	Sets the brightness (shutter speed) increment count.
Decrement count	0 to 10 (Default: 2)	Sets the brightness (shutter speed) decrement count.

Setting scene retry

- Set the retry mode to [Scene retry] in "Retry details".

▶  (Setup Mode) – [Sensor settings] – [Retry details]

- 1 Press [Scene retry] for the retry mode.
- 2 Set the switch order.
- 3 Set the scenes that are switched through.



Parameter	Settings	Description
Switch Order	Auto (Default) Fixed	Sets the scene switching order. Auto: Switches through the scenes in the order of highest frequency of use. Fixed: Switches through the scenes in the order that the scenes were registered for scene switching.
Retry scene	1st to 32nd	Register the scenes for scene switching. Register the scenes to switch in order from "1st" If there are any scenes for scene switching that are not registered, the remaining scenes are ignored.

Reading order of the Sort order

The scanning procedure when the sort order is set to auto is shown below.

1st : The last Scene which was scanned successfully.
2nd and following: Scene order by most successful scans

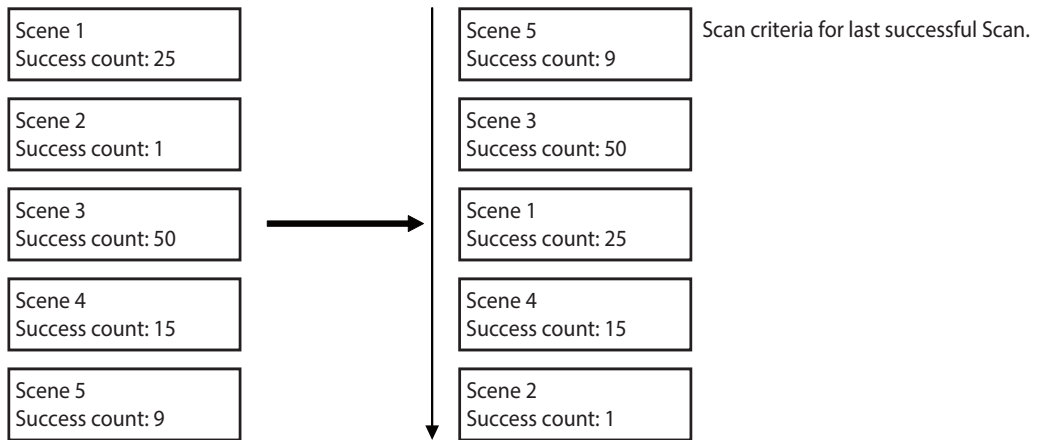

- In the Default state, the order is the order of the scene numbers.
- If the power is interrupted or the sensor is restarted, the success counts are initialized when adjust mode is entered.

Note

For the timing chart, refer to the following manual:

 *FQ2-S/CH Series User's Manual for Communications Settings (Cat. No. Z338)*

7-12 Functions Related to the System

FQ2-S1

FQ2-S2

FQ2-S3

FQ2-S4

FQ2-CH

This section describes system settings.

Turning OFF the Integrated Sensor Lighting (Only Sensors with Built-in Lighting)

The internal light can be turned OFF to use external illumination.

▶  – [Camera setup] – [] – [Lighting control]
Press [OFF].

Switching the Display Language

Any of the following languages can be selected for display on the Touch Panel or PC Tool.
Japanese, English, German, French, Italian, Spanish, Traditional Chinese, Simplified Chinese, or Korean

▶  (Setup Mode or Run Mode) – [TF settings] – [Language]

Press the language to be displayed.

Setting the Time on the TouchFinder

You can set the date and time.

▶  (Setup Mode or Run Mode) – [TF settings] – [Time settings]

Setting the Day and Time Information

Sensor does not have day and time information.
When you want to use Calendar Matching in OCR, day and time setting is required.

▶  (Setup Mode) – [Sensor settings] – [Sensor Day/Time]

 *Set or Acquire the Date and Time: p. 167*

Initializing the Sensor and Touch Finder

- Initializing the Sensor

- ▶  (Setup Mode) – [Sensor settings] – [Initialize]

- Initializing the Touch Finder

- ▶  (Setup Mode or Run Mode) – [TF settings] – [Initialize]

Restarting the Sensor and Touch Finder

- Restarting the Sensor

- ▶  (Setup Mode) – [Sensor settings] – [Restart]

- Restarting the Touch Finder

- ▶  (Setup Mode or Run Mode) – [TF settings] – [Restart]

Checking Versions

- Checking the Sensor Version

- ▶  (Setup Mode) – [Sensor settings] – [Information]

- Checking the Touch Finder Version

- ▶  (Setup Mode or Run Mode) – [TF settings] – [Information]

Checking the Touch Finder Battery Level

- Checking the Sensor Version

- ▶  (Setup Mode or Run Mode) – [TF settings] – [Battery level]

Important

- The battery level is displayed only for a Touch Finder with a DC/AC/battery power supply (FQ2-D31).
- The settings will be lost if the battery runs out while you are making the settings. If the battery level is low, save the settings and charge the battery immediately.

Changing the Sensor Name

An alphanumeric name can be assigned to a Sensor to make it easier to recognize. This is convenient when more than one Sensor is connected.

- ▶  (Setup Mode) – [Sensor settings] – [Information] – [◀] – [Rename]

Checking Available Memory in the Sensor

If a setting cannot be made, check the amount of memory that is available in the Sensor.

- ▶  (Setup Mode) – [Sensor settings] – [Information] – [◀] – [Memory state]

Correcting the Touch Screen Positions of the Touch Finder

Use this function to correct the touch screen positions if they are offset from the opposite position.

- ▶  (Setup Mode) – [TF settings] – [Touch screen calib]

Setting the Resolution of Measurement Objects Displayed on the PC Tool

Use this function to set the resolution of measurement object that are displayed on the Touch Finder on the computer.

- ▶  (Run Mode) – [TF settings] – [Resolution]

Changing the Sensor's BUSY Indicator

You can change the BUSY indicator to a RUN indicator.

- ▶ [In/Out] – [In/Out setting] – [In/Out setting] – [Output] – [BUSY LERD]

Setting the Inspection Timeout Time (FQ2-S4 series or FQ2-CH series only)

The time after which inspection times out can be set (msec).

- ▶  (Setup Mode) – [Sensor settings] – [Timeout]

MEMO

Troubleshooting

8-1 Error Histories	432
8-2 Error Messages	434
8-3 Basic Troubleshooting	435

8-1 Error Histories

FQ2-S1

FQ2-S2

FQ2-S3

FQ2-S4

FQ2-CH

Error histories are stored with the PC Tool and in the Sensor and in the Touch Finder. Up to 100 errors will be stored in the error history in the Sensor or Touch Finder.

Errors Stored in the Error History

Error code	Cause	Points to check	Measures to perform
TRIG Input Error  (Error code (hex): 01040302)	A TRIG signal was input when the BUSY signal for Sensor measurement was ON.	<ul style="list-style-type: none"> Check the program in the PLC or other host to see if an interlock or similar measure has been implemented. If a relay or other device with contacts is being used as the input device, see if chattering has occurred. 	<ul style="list-style-type: none"> Program interlocks to control the TRIG so that they do not turn ON while the BUSY signal is ON. Switch from a device with contacts (e.g., relay) to a device without contacts (e.g., SSR or PLC transistor output).
IN Input Error  (Error code (hex): 11020900)	A parallel command was input while the BUSY signal was ON.	<ul style="list-style-type: none"> Is an interlock or other countermeasure provided, e.g., in a ladder program in the PLC? Is the wiring appropriate? 	<ul style="list-style-type: none"> Interlock so that a parallel command is not input when the BUSY signal is ON in a ladder or otherwise. Malfunctioning will occur if the power ground level of the FQ-S is different from the power ground level of the connected IO device. Short the two power GNDs together.
Scene Data Error  (Error code (hex): 01030800)	The scene data to switch to is corrupted.	---	The scene data to be switched to is corrupted. Reset the scene data from the beginning.
Model Error  (Error code (hex): 01050405 or 01050500)	A model was re-registered with an image with low contrast.	Check the image to see if the contrast is too low to register the model.	Increase the image contrast and try again to register the model.
Logging Error (Error code (hex): 02160702 or 02160703)	Some data was not saved when logging data to files on an SD card.	Check to see if the BUSY output parameter is set to <i>Measurement</i> .	Set a sufficiently long measurement interval or set the BUSY output condition to [Data logging] or [Image logging].
Communication error (Error code (hex): 01010100)	After EtherNet/IP communication or PROFINET communication was established, normal communication could not be performed.	Check to see if communications were cut off with the data link partner device and to see if a cable is broken.	Check the cable connection to the data link partner device.
EtherNet/IP communications error (Error code (hex): 01010101)	A timeout occurred in processing to output the measurement results via EtherNet/IP, PROFINET.	Make sure that handshake processing is being performed by the master. Also, make sure that the measurement interval is long enough.	Check the measurement interval and handshake processing. Change the timeout time so that it is suitable for the ladder program processing time.
Output buffer error (Error code (hex): 01010701)	An output data buffer overflow occurred during output processing of measurement results for PLC Link or EtherNet/IP, PROFINET.	<ul style="list-style-type: none"> Check the measurement interval to see if it is long enough. Make sure that handshake processing is being performed by the master. 	Check the measurement interval and handshake processing.
SD card output error (Error code (hex): 01050300)	A write to the SD card failed. An attempt was made to save more data than the available space on the SD card.	<ul style="list-style-type: none"> Check to see if the SD card is locked. Check to see if there is sufficient space available on the SD card. Verify that the SD card's format is FAT/ FAT32. 	<ul style="list-style-type: none"> Make the SD card's format FAT or FAT32 using a PC.

Note:  ERR If an error that is indicated by this icon occurs, the ERROR operation indicator will light and the ERROR signal will turn ON.

Note

You cannot check the error codes from the Touch Finder. Use the command to acquire the most recent error information for the connection method.

 *FQ2-S/CH Series User's Manual for Communications Settings (Cat. No. Z338)*

Checking the Error Histories

• Checking the History of Errors That Have Occurred in the Sensor

- ▶  (Setup Mode) – [Sensor settings] – [Error history] – [View history]

Errors will be displayed in order with the most recent ones on top.

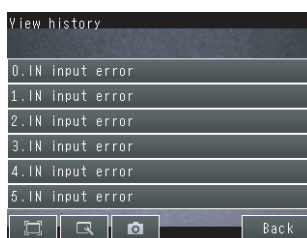

• Checking the Log of Errors That Have Occurred in the Touch Finder

- ▶  (Setup Mode or Run Mode) – [TF settings] – [Error history] – [View history]

Clearing the Error Histories

• Deleting the History of Errors That Were Detected in the Sensor

- ▶  (Setup Mode) – [Sensor settings] – [Error history] – [Delete history]

• Deleting the History of Errors That Were Detected in the Touch Finder

- ▶  (Setup Mode or Run Mode) – [TF settings] – [Error history] – [Delete history]

8-2 Error Messages

FQ2-S1

FQ2-S2

FQ2-S3

FQ2-S4

FQ2-CH

If an error occurs while making settings on the PC Tool or the Touch Finder, an error message will appear on the display.

For these errors, the ERR indicator on the Sensor will not light, the ERROR signal will not be output, and the error will not be recorded in the error history.

Follow the instructions that are given in the error message.

If the following messages appear, the hardware may be faulty.

Contact your OMRON representative.

- System error.
- Application system error. Please reboot.
- Failed to startup.

8-3 Basic Troubleshooting

FQ2-S1

FQ2-S2

FQ2-S3

FQ2-S4

FQ2-CH

Problem	Measures to perform	
The Sensor or Touch Finder will not start.	Check the power supply capacity to see if it is sufficient.	---
The Sensor cannot be detected.	Check the Ethernet cable to see if it is connected correctly.	---
	Check the Ethernet settings to see if they are correct between the devices.	p. 67
	If you do not know the IP address of the sensor, execute [TF settings] - [Re-assign IP forcibly]. The sensor IP address will be assigned based on the network settings of the computer.	p. 436
	Check the communications cable to see if it is disconnected.	---
	Check the switching hubs to see if any of them are faulty. (If switching hubs are used.)	---
	No more than a combined total of two PC Tool / Touch Finder units can be connected at once. If the PC Tool or Touch Finder is already connected to the Sensor, disconnect it.	---
The Setup Mode display opens.	Check if an inspection item is set in the scene of the connected FQ. If an inspection item is set in the scene of the connected FQ, the Run Mode display will open at startup. If the Touch Finder is started when the scene of the connected FQ does not have an inspection item set, the Setup Mode display will open.	p. 29
The judgement result JG is -15 (out of range error) during measurement.	An area where the image does not exist is included in the measurement area due to position compensation or partial input. Change the settings so that the area where the image exists is the measurement area.	---
"Touch Finder setting version error" appears when switching Sensors or switching between the Run Mode and Setup Mode displays at startup (Sensor software version 1.91 or later).	This appears when the Touch Finder software version is older than the Sensor software version. Functions not supported by the Touch Finder are shown as "XXX". Update the Touch Finder software to the latest version.	p. 574
The results display is not updated.	Check to see if the TRIG signal is being correctly input to the Sensor.	p. 385
	Check to see if the most recent NG result is being displayed.	p. 383
Updating the results display is slow.	If other devices are connected to the same network as the Sensor, disconnect the other devices from the network and check the update speed. If the update speed returns to normal, check the specifications of the disconnected devices and take suitable measures.	---
	If there are power lines running in parallel with the Ethernet cable or if there are inverters or other sources of noise near the communications cable, separate the communications cable from them and check the update speed. Noise may be adversely affecting the communications response.	---
Data is not logged properly.	Check to see if the logging setting in the Sensor are correct.	p. 392
	If logging to an SD card is not possible, check the available space on the SD card and check to see if the SD card is write-protected.	p. 409
The ERROR indicator lights.	Check the error history to see what error has occurred and take suitable measures.	p. 432
The measurement trigger is not input.	Check to see if the measurement trigger is set correctly.	---
The image brightness does not stabilize. (FQ2-S1□□□□□/ FQ2-S2□□□□□/ FQ2-S3□□□□□/ FQ2-S3□□□□□-M/ FQ2-S4□□□□□/ FQ2-S4□□□□□M/ FQ2-CH only)	Turn ON the brightness correction mode. When the Brightness Correction Mode is ON, the timing when images are taken changes. Check that the images of the measured objects taken when the Brightness Correction Mode is ON are appropriate.	p. 78

Restoring a Sensor Connection

If you cannot connect to a sensor because the sensor is not detected in the [Sensor List] and the IP address set in the sensor is unknown, you can execute [Re-assign IP forcibly] to forcibly change the IP address of the sensor and connect.

The sensor' IP address will be re-assigned as shown below based on the IP address settings of the Touch Finder (PC Tool) that is connected to the sensor.

Example: Settings on computer

[IP] : 10.5.5.50
[Subnetmask] : 255.255.255.0
[Defaultgateway] : 10.5.5.1



Settings on FQ2

[IP] : 10.5.5.XXX
[Subnetmask] : 255.255.255.0
[Defaultgateway] : 10.5.5.1

XXX: The host part is automatically assigned

Important

- Execute this function with the Touch Finder (PC Tool) in a one-to-one connection with the sensor. If connected to multiple sensors, IP address assignment will be performed for all sensors and reconnection will not take place normally.
- The reassign IP address function is valid for Version 1.84 and later sensors.

1 Configure the network settings (IP address, subnet mask, and Default gateway) of the Touch Finder (PC Tool).

2 Connect the sensor and the Touch Finder (PC Tool) in a one-to-one connection.
(If the sensor is connected via a network, disconnect the sensor from the network.)

3 Press  (Run Mode) - [TF settings] - [Re-assign IP forcibly].

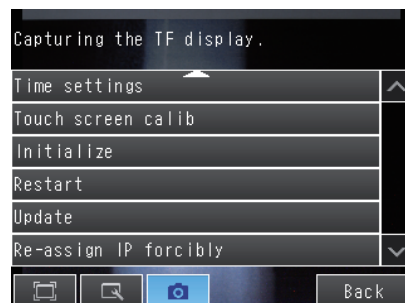

4 Make sure that the sensor and Touch Finder are connected in a one-to-one connection, and press [Yes].



Appendices

9-1 Menu Tables	438
9-2 External Reference Parameters	477
9-3 Specifications and Dimensions	546
9-4 Updating the Software	573
9-5 Connecting a Previous Touch Finder (FQ-D30/D31) to the FQ2-S Sensor	574
Index	580
Revision History	586

9-1 Menu Tables

FQ2-S1

FQ2-S2

FQ2-S3

FQ2-S4

FQ2-CH

Image Tab Page

Menu command		Description	Setting range	Data	
Camera setup ◀	Focus	The value shown here is used as a reference when adjusting the focus with the focus adjustment screw.	---	---	p. 76
	Image mode	Pixel sampling can be applied to the input image to reduce image input time.	<ul style="list-style-type: none"> Normal (Default) Fast 	Scene	p. 345
	Shutter speed (Normal mode)	Sets the shutter speed for Normal Mode.	<ul style="list-style-type: none"> FQ2-S4□-□□□□ 1/1 to 1/4,155 FQ2-S3, FQ2-S4□□□□□-08□ Built-in lighting off: 1/1 to 1/4,155 Built-in lighting on: 1/250 to 1/60,000 (control by lighting emission time) FQ2-S1, FQ2-S2, FQ2-S4□□□□□, FQ2-S4□□□□□-M, FQ2-CH Built-in lighting off: 1/1 to 1/50,000 Built-in lighting on: 1/250 to 1/50,000 (control by lighting emission time) Default: 1/250 	Scene	p. 80
	Gain (Normal mode)	If the gain is high, the image will be bright. If the gain is low, the image will be dark.	<ul style="list-style-type: none"> FQ2-S3, FQ2-S4□□□□□-08□, FQ2-S4□-□□□□ Range: 0 to 10 (Default: 10) FQ2-S1, FQ2-S2, FQ2-S4□□□□□□□□, FQ2-S4□□□□□□□□-M, FQ2-CH Range: 16 to 64 (Default: 16) 	Scene	p. 80
	Brightness correction (When HDR mode is OFF.)	Use to stabilize the brightness.	<ul style="list-style-type: none"> ON OFF (Default) 	System	p. 78
	Brightness (HDR mode)	Sets the brightness level of the image for HDR Mode.	1 to 100	Scene	p. 81
	Brightness correction (HDR mode)	Use to stabilize the brightness.	<ul style="list-style-type: none"> ON OFF (Default) 	System	p. 78
	HDR	Suppresses reflections and differences in brightness.	<ul style="list-style-type: none"> OFF (Default) Level 1 to Level4 	Scene	p. 83
	White balance	Corrects differences in coloring between the image and the actual object.	<ul style="list-style-type: none"> AUTO R: 0.001 to 7.999 G: 0.001 to 7.999 B: 0.001 to 7.999 	Scene	p. 85

Menu command		Description	Setting range	Data		
Camera setup	Partial input	Used to make the image input range smaller.	<ul style="list-style-type: none"> • 752×8 to 752×480 FQ2-S1□□□□□□ FQ2-S2□□□□□□ FQ2-S4□□□□□□ FQ2-S4□□□□□□-M FQ2-CH 	Scene	p. 343	
			<ul style="list-style-type: none"> • 928×8 to 928×828 FQ2-S□□□□□□-08□ FQ2-S4□□□□□□-08□ 			
			<ul style="list-style-type: none"> • 1280×8 to 1280×1024 FQ2-S3□-□8□ FQ2-S4□-□□□ 			
	Rotate 180	You can rotate the Camera image by 180°.	<ul style="list-style-type: none"> • ON • OFF (Default) 	Scene	p. 86	
	Calibration setting	Sets a registered calibration pattern.	<ul style="list-style-type: none"> • Off (Default) Calibration Data 0 to 31 	Scene	p. 379	
Lighting control	Turns off built-in lighting when external lighting is used.	<ul style="list-style-type: none"> • ON (Default) • OFF 	Scene	p. 427		
Lightning control	Strobe output delay	Sets the delay time for the strobe output signal (STGOUT) in response to the trigger signal.	0 to 65,535 μs (Default: 0 μs)	Scene	---*1	
	Strobe output time	Sets the output time of the strobe output signal (STGOUT).	0 to 65,535 μs (Default: 1,000 μs)	Scene	---*1	
Trigger setup	Trigger delay	Adjusts the time until the Camera shutter opens after the trigger signal is received. Only valid for external triggers.	0 to 163 ms (Default: 0)	System	p. 87	
Image adjustment	Add filter	These commands are used to add, modify, delete, copy, or change the name of filter items and position compensation items.	<ul style="list-style-type: none"> • Color Gray Filter • Weak Smoothing • Strong Smoothing • Dilate • Erosion • Median • Extract Edges • Extract Horiz • Edges • Extract vertical edges • Enhance edges • Background Suppression 	Scene	p. 94	
	Add pos. comp.		Model	<ul style="list-style-type: none"> • Shape Sear III. pos. comp • Shape Sear. pos. comp • Search position comp 	Scene	p. 102
			Edge	<ul style="list-style-type: none"> • Edge position comp • 2Edge position comp • 2ed. midp. comp • Edge rot. pos. Comp 	Scene	p. 102
			Value	Position compensation (Image rotation,Parameter)	Scene	p. 102
	Modify			---	---	p. 94
	Delete			---	---	p. 94
	Copy			---	---	p. 94
	Rename			15 alphanumeric characters	Scene	p. 94

Menu command		Description	Setting range	Data				
Image adjustment	(Color Gray Filter)	Filter type	You can specify the ranges of colors to which the Color Gray Filter item is applied.	<ul style="list-style-type: none"> • RGB (Default) • HSV 	Scene	p. 96		
		Filter settings	Select the type of color filter to use.	<ul style="list-style-type: none"> • Red filter (Default) • Green filter • Blue filter • Cyan filter • Magenta filter • Yellow filter • Brgt.F. (R+G+B) • Brgt.F. (R+2G+B) • Custom filter 	Scene	p. 96		
		Source image	You must set the image to which the filter is to be applied.	<ul style="list-style-type: none"> • Camera • Prev. (Default) 	Scene	p. 95		
	(Items other than Color Gray Filter)	Filter region	You can specify the region to which to apply the filter.	---	Scene	p. 95		
		Source image	You must set the image to which the filter is to be applied.	<ul style="list-style-type: none"> • Camera • Prev. (Default) 	Scene	p. 95		
		Suppression level (for Background Suppression Item Only)	The range in which to enhance the contrast and the brightness range to extract are set for the Background Suppression item.	---	Scene	p. 98		
	Basic	Teach	for Search Position Compensation, Shape Search Position Compensation, and Shape Search Position Ill Compensation	Model region	---	Scene	---	
				Add	Used to specify the region of the image to register as the model with a combination of figures.	<ul style="list-style-type: none"> • Rectangle • Ellipse • Wide circle • Polygon 	Scene	---
				Delete		---	Scene	---
Copy				---		Scene	---	
Console				---		Scene	---	
OR/NOT				<ul style="list-style-type: none"> • OR (Default) • NOT 		Scene	---	
One/All				<ul style="list-style-type: none"> • One (Default) • All 		Scene	---	
Insp. region				Adjusts the size and position of the measurement region.	---	Scene	---	
Detection point			You can specify which part of the model to detect as coordinates during inspections.	---	Scene	---		

Menu command		Description	Setting range	Data			
Image adjustment (Position compensation items)	Basic Teach	for Edge Position Compensation 	Insp. region	Adjusts the size and position of the measurement region, changes the measurement direction, etc.	---	Scene	---
			Color ON/OFF	Sets whether to specify an edge color.	<ul style="list-style-type: none"> • ON • OFF (Default) 	Scene	
	Set color.		Specifies the color of the image for edge detection (i.e., the border between the measurement object and background).	<ul style="list-style-type: none"> • R: 0 to 255 • B: 0 to 255 • G: 0 to 255 	Scene	---	
	Color palette		Displays a palette for color specification.				
	Detection mode OUT		Specifies whether to detect a change in color as an edge.	<ul style="list-style-type: none"> • Color IN (Default) • Color 	Scene	---	
	for Two-edge Position Compensation, Two-edge Midpoint Compensation, and Edge Rotation Position Compensation 	Edge 0 region, Edge 1 region	Adjusts the size and position of the measurement region, changes the measurement direction, etc.	---	Scene	---	
		Edge 0 clr ON/OFF Edge 1 clr ON/OFF	Sets whether to specify an edge color.	<ul style="list-style-type: none"> • ON • OFF (Default) 	Scene	---	
		Edge 0 set color. Edge 1 set color.	Specifies the color of the image for edge detection (i.e., the border between the measurement object and background).	<ul style="list-style-type: none"> • R: 0 to 255 • B: 0 to 255 • G: 0 to 255 	Scene	---	
		Color palette	Displays a palette for color specification.				
		Detection mode	Specifies whether to detect a change in color as an edge.	<ul style="list-style-type: none"> • Color IN (Default) • Color OUT 			
		Edit Ref. angle (Edge Rotation Position Compensation only)	Set the reference angle.	-180 to 180° (Default:0)	Scene	---	
	Judgement	<ul style="list-style-type: none"> • Shape Search III Position Compensation Item, Shape Search Position Compensation Item, and Search Position Compensation Item Almost the same as for the Shape Search III, Shape Search II, and Search inspection item. • Edge Position Compensation, Two-edge Position Compensation, Two-edge Midpoint Compensation, and Edge Rotation Position Compensation Almost the same as for the Edge Position inspection item. 		Scene	---		

Menu command		Description	Setting range	Data			
Image adjustment (Position compensation items)	Details	Model parameters (Shape Search and Shape Search III Position Compensation Items only)	<ul style="list-style-type: none"> Shape Search Position Compensation Item and Search Position Compensation Item Almost the same as for the Shape Search III, Shape Search II, and Search inspection item. However, the [Sub-pixel] and [Multi-point output] settings of the Search inspection item do not exist. Edge Position Compensation, Two-edge Position Compensation, Two-edge Mid-point Compensation, and Edge Rotation Position Compensation The settings for the Edge Position Compensation item are almost the same as those for the Edge Position inspection item. 	Scene	---		
		Meas. Parameter		Scene	---		
		Output parameter		Scene	---		
	Scroll parameter	Source image	You can select the image to which to apply the results of position compensation processing.	<ul style="list-style-type: none"> Camera Prev. (Default) 	Scene	p. 107	
		Interpolation	You can select the precision of position compensation.	<ul style="list-style-type: none"> Bilinear None (Default) 	Scene	p. 108	
	for Position Compensation (Image rotation, Parameter)	Image rotation		Select to correct the position by rotating the image around the center of the screen.	-180° to 180° (Default: 90°)	Scene	p. 126
Parameter		Reference position	Reference position X coordinate	Sets the X coordinate of the reference position.	-99999 to 99999 (Default: p. 127)	Scene	p. 126
			Reference position Y coordinate	Sets the Y coordinate of the reference position.	-99999 to 99999 (Default: p. 127)	Scene	
			Reference angle	Sets the reference angle θ .	-180 to 180 (Default: 90)	Scene	
Measurement position		Measurement position X coordinate	Sets the X coordinate of the measurement position.	-99999 to 99999 (Default: p. 127)	Scene		
		Measurement position Y coordinate	Sets the Y coordinate of the measurement position.	-99999 to 99999 (Default: p. 127)	Scene		
		Measurement angle	Sets the measurement angle θ .	-180 to 180 (Default: 0)	Scene		
for Linear Correction	Ref. position		Sets the reference position.	---	Scene	p. 129	
	Meas. position		Sets the measurement position.	---	Scene	p. 129	
	Filter region		You can specify the range over which position correction is performed.	---	Scene	p. 131	
	Source image		You must set the image to which the filter is to be applied.	<ul style="list-style-type: none"> Camera Prev. (Default) 	Scene	p. 132	
	Interpolation		You can select the precision of position compensation.	<ul style="list-style-type: none"> None Bilinear (Default) 	Scene	p. 132	



*1 Refer to FQ2-S/CH Series User's Manual for Communications Settings (Cat. No. Z338).

Inspect Tab Page

Menu command		Description	Setting range	Data			
Inspection	Item selected	Add item Used to add, modify, delete, copy, or change the name of an inspection item.	<ul style="list-style-type: none"> • OCR^{*4} • Bar code^{*3} • 2D-code^{*3} • 2D-code (DPM)^{*3} • Search^{*2} • ShapeSearch III ^{*2} • Shape Search II^{*2} • Sensitive Search^{*2} • Edge Position^{*2} • Edge Width^{*2} • Edge Pitch^{*2} • Color Data^{*2} • Area • Labeling^{*2} 	---	p. 138		
				Modify	---	p. 139	
				Delete	---		
				Copy	---	p. 139	
				Rename	15 alphanumeric characters	Scene	
	Settings	Teach	Teach Mode	Set the Teach Mode.	<ul style="list-style-type: none"> • Simple Teach (Default) • Correct String 	Scene	p. 142
			Insp. region	Moves the measurement region or adjusts the size of the measurement region.	---	Scene	p. 141
		Format	L. 1 to L. 4	Sets the character format for recognition.	32 alphanumeric characters	Scene	p. 141
			Correct String	L. 1 to L. 4	Sets the character format for recognition.	32 alphanumeric characters	Scene
		Camera setup		Same as Camera adjustments on the Image Tab Page.		Scene	p. 76
Meas. Parameter		Reading Speed	Set the Reading Speed.	<ul style="list-style-type: none"> • Normal (Default) • Fast 	Scene	p. 156	
		Character color	Sets the color of the characters to detect.	<ul style="list-style-type: none"> • Black (Default) • White 	Scene		
		Printing type	Sets the type of printing of the characters to detect.	<ul style="list-style-type: none"> • Solid character • Dot character (Default) 	Scene		
		Dot ver. interval	Adjusts the vertical dot interval of the characters to detect. This parameter is enabled only when [Printing type] is set to [Dot character].	0 (Default) to 30	Scene		
		Dot hor. interval	Adjusts the horizontal dot interval of the characters to detect. This parameter is enabled only when [Printing type] is set to [Dot character].	0 (Default) to 30	Scene	p. 156	
	Char. thick. th.	Sets the thickness of the characters. Negative numbers indicate thinner characters. Positive numbers indicate thicker characters.	-128 to 128 (Default: 0)	Scene			
Boundary correction	Treats dark areas at the edges of the measurement region as noise and removes them from the read candidates.	<ul style="list-style-type: none"> • ON (Default) • OFF 	Scene				

Menu command		Description	Setting range	Data		
Inspection Settings	Teach for OCR*4 Meas. Parameter	Rotation compensation	Turned ON when characters on the workpiece are rotated because the workpiece itself is rotated. Correction is possible in a rotation range of $\pm 15^\circ$.	<ul style="list-style-type: none"> • ON • OFF (Default) 	Scene	p. 156
		Slant compensation	Used when the characters are at a slant. Correction is possible in a rotation range of $\pm 15^\circ$.	<ul style="list-style-type: none"> • ON • OFF (Default) 	Scene	
		Hyphen height upper.	Sets the upper limit of the height of the region to treat as a hyphen or other symbol.	0 to 100 (Default: 30)	Scene	
		Hyphen height lower.	Sets the lower limit of the height of the region to treat as a hyphen or other symbol.	0 to 100 (Default: 70)	Scene	
		Slender char. th.	Sets the ratio of the height to the width of the detection rectangle to judge as thin characters (l, j, 1, :, and /).	1 to 10 (Default: 3)	Scene	p. 156
		Max Width Setting	Set the Max Width Setting.	<ul style="list-style-type: none"> • ON • OFF (Default) 	Scene	
		Max Width	specify the max width for attempted character string.	0 to 9,999 (Default: 0)	Scene	
		Max Height	Specify the max height of the character to be read.	0 to 9,999 (Default: 0)	Scene	
		Min Height	Specify the min height of the character to be read.	0 to 100 (Default: 50)	Scene	
		Reading Length	If character strings with a variable number of characters are to be read, specify variable.	<ul style="list-style-type: none"> • Variable (Default) • Fixed 	Scene	
	Continuous test	Same as [Continuous test] on the [Test] Tab Page.		---	---	p. 340
	for Bar code*3 Meas. Parameter	Insp. region	Moves the measurement region or adjusts the size of the measurement region.	---	Scene	---
		Camera setup	Same as Camera adjustments on the Image Tab Page.		Scene	p. 76
		Code type	Sets the type of code to read.	<ul style="list-style-type: none"> • JAN/EAN/UPC (Default) • Code39 • Codebar • ITF • Code93 • Code128 / GS 1-128 • GS1 DataBar • Pharmacode 	Scene	p. 186
		Code color	Sets the color of the code to be read.	<ul style="list-style-type: none"> • Black (Default) • White 	Scene	p. 186
		Composite codes on/off	Sets whether or not composite codes are supported. (Only valid for Code128/GS1-128, GS1 Databar)	<ul style="list-style-type: none"> • Yes • No (Default) 	Scene	
		Check digit on/off (Except for Pharmacode)	Sets whether there is a check digit.	<ul style="list-style-type: none"> • Yes (Default) • No 	Scene	
		Direction (For Pharmacode only)	Sets the direction in which to read.	<ul style="list-style-type: none"> • Horizontal mode (Default) • Vertical mode 	Scene	
	Reverse on/off (For Pharmacode only)	Sets whether to use Reverse Mode.	<ul style="list-style-type: none"> • Yes • No (Default) 	Scene		

Menu command		Description	Setting range	Data						
Inspection	Settings	Teach	for Bar code ^{*3}	Meas. Parameter	Timeout	Sets the timeout time for read processing.	1 to 9999 ms (Default: 9999)	Scene		
				Continuous test	Same as [Continuous test] on the [Test] Tab Page.		---	p. 340		
				Insp. region	Moves the measurement region or adjusts the size of the measurement region.	---	Scene	---		
				Camera setup	Same as Camera adjustments on the Image Tab Page.		Scene	p. 76		
				Meas. Parameter	Code type	Sets the type of code to read.	<ul style="list-style-type: none"> JAN/EAN/UPC (Default) Code39 Codebar ITF Code128/GS 1-128 Pharmacode 	Scene	p. 196	
					Reverse (Other than PDF417, Micro-PDF417)	Sets a normal or reverse image.	<ul style="list-style-type: none"> Normal (Default) Reverse 	Scene		
					Code color (Other than PDF417, Micro-PDF417)	Sets the code color.	<ul style="list-style-type: none"> Black (Default) White 	Scene		
					Grid correction (Micro QR Codes only)	Set whether grid correction is ON or OFF.	<ul style="list-style-type: none"> ON OFF (Default) 	Scene		
					Shape (for DataMatrix Only)	Sets the code shape.	<ul style="list-style-type: none"> Square (Default) Square Rect. 	Scene		
					Print quality (Data Matrix only)	Sets print quality evaluation ON/OFF.	<ul style="list-style-type: none"> ON OFF (Default) 	Scene		
					Timeout	Sets the timeout time for read processing.	1 to 9999 ms (Default: 9999)	Scene		
					Continuous test	Same as [Continuous test] on the [Test] Tab Page.		---		p. 340
				for 2D-code (DPM) ^{*3}	Meas. Parameter	Insp. region	Moves the measurement region or adjusts the size of the measurement region.	---	Scene	---
						Camera setup	Same as Camera adjustments on the Image Tab Page.		Scene	p. 76
						Code type	Sets the type of code to read.	<ul style="list-style-type: none"> DataMatrix (Default) QR MicroQRCode PDF417 MicroPDF417 	Scene	p. 210
						Shape (for DataMatrix only)	Sets the code shape.	<ul style="list-style-type: none"> Square (Default) Rectangle 	Scene	
						QR Code Model (for QR Code only)	Sets the QR code model.	<ul style="list-style-type: none"> Model 1 Model 2 Auto (Default) 	Scene	
						ECC Level (for QR Code only)	Sets the error correction level (i.e., the ECC level).	<ul style="list-style-type: none"> L (7%) M (15%) Q (25%) H (30%) Auto (Default) 	Scene	

Menu command		Description	Setting range	Data						
Inspection	Settings	Teach	for 2D-code (DPM)*3	Meas. Parameter		Cell (for DataMatrix and QR Code only)	Sets the number of cells in the code.	For QR codes 21 × 21, 25 × 25, 29 × 29, 33 × 33, 37 × 37, 41 × 41, 45 × 45, 49 × 49, 53 × 53, 57 × 57, or Auto (default)	Scene	
						Auto length (Except for when the number of cells is set to automatic for data matrices or QR codes.)	Sets whether the code size is detected automatically.	<ul style="list-style-type: none"> • Yes (Default) • No 		
						Reverse	Sets a normal or reverse image.	<ul style="list-style-type: none"> • Normal • Reverse • Auto (Default) 		
						Code color	Sets the code color.	<ul style="list-style-type: none"> • Black • White • Auto (Default) 		
						Grid correction	Set whether grid correction is ON or OFF.	<ul style="list-style-type: none"> • ON • OFF (Default) 		
						Fast mode	Sets whether to use the Fast Mode. Reading time is reduced if Fast Mode is used.	<ul style="list-style-type: none"> • Yes • No (Default) 		
						DPM print quality (Data Matrix only)	Sets print quality evaluation ON/OFF.	<ul style="list-style-type: none"> • ON • OFF (Default) 		
						Timeout	Sets the timeout time for read processing.	0 to 9999 ms (Default: 9999)		
		Continuous test	Same as [Continuous test] on the [Test] Tab Page.	---	p. 210					

Menu command		Description	Setting range	Data		
Inspection Settings	Teach (Search ⁺ , Shape search II ⁺ , Shape search III ⁺ , Sensitive search ⁺)	Model region		---	Scene	p. 224 p. 244 p. 225
		Add	Used to specify the region of the image to register as the model with a combination of figures.	<ul style="list-style-type: none"> • Rectangle • Ellipse • Wide circle • Polygon 	Scene	p. 225
		Delete		---	Scene	
		Copy		---	Scene	---
		Console		---	Scene	p. 227
		OR/NOT		<ul style="list-style-type: none"> • OR (Default) • NOT 	Scene	p. 226
		One/All		<ul style="list-style-type: none"> • One (Default) • All 	Scene	---
		Insp. region		Adjusts the size and position of the measurement region.	---	Scene
		Detection point	You can specify which part of the model to detect as coordinates during inspections.	---	Scene	p. 228
		Insp. region	Adjusts the size and position of the measurement region, changes the measurement direction, etc.	---	Scene	p. 279 p. 285 p. 291
		Edge Setting				
		Mask size	Select the pixel size to be used at	<ul style="list-style-type: none"> • 3×3(Default) • 5×5 • 7×7 		
		Edge level auto	The [Edge level] can be set automatically by selecting ON. If edge recognition results are not good with this setting, set to OFF.	<ul style="list-style-type: none"> • ON (Default) • OFF 		
		Edge level	This function will be enabled if you uncheck [Auto] check box. Set the lower limit to recognize the [Edge level]. Edges higher than set value are recognized. Decrease the setting value when it is difficult to find edges. Increase the setting value when the effect of noise is high.	0 to 1024 (Default: 20)	Scene	p. 239
		Noise Removal Level	Specify the upper value to remove noise.	0 to 100 (Default: 0)		
		Disp. Image Selection	Select the displayed image.	<ul style="list-style-type: none"> • Meas. Img. • Meas. Img.+Model Img (Default) • Edge Image • Edge Img.+ Model Img. 		
		Insp. region	Adjusts the size and position of the measurement region, changes the measurement direction, etc.	---	Scene	
		Color ON/OFF (for Edge width and Edge position Only)	Sets whether to specify an edge color.	<ul style="list-style-type: none"> • ON • OFF(Default) 		p. 278

Menu command		Description	Setting range	Data			
Inspection	Settings	Teach for Edge Position*2, Edge Width*2, and Edge Pitch*2	Set color	Specifies the color of the image for edge detection (i.e., the border between the measurement object and background).			
			Color palette	Displays a palette for color specification.	R: 0 to 255 B: 0 to 255 G: 0 to 255		
			Detection mode	Select the situation when the Edge is detected.	<ul style="list-style-type: none"> Color IN (Default) Color OUT 		
	for Area*2, Labeling*2	Insp. region	Insp. region	Adjusts the size and position of the measurement region.	---	Scene	p. 308 p. 320
			Set color	The color for which to find the area is specified.	---	Scene	
			Color palette	Displays a palette for color specification.	<ul style="list-style-type: none"> Hue: 0 to 359 Saturation: 0 to 255 Brightness: 0 to 255 Exclusion: ON or OFF Color inv.: Yes or No (Default) 	Scene	p. 305 p. 314
			Display Setting	Specifies the type of image to display on the color specification display to check on the image the color that was set for the reference color.	<ul style="list-style-type: none"> Measurement Image All Color Image (Default) Selected Color Image Binary Image 	Scene	
			Background color	Specifies the background color of the extracted image.	<ul style="list-style-type: none"> Black (Default) White Red Green Blue 	Scene	
	for Color Data*2	Insp. region	Insp. region	Moves the measurement region or adjusts the size of the measurement region.	---	Scene	p. 299
			Judgement			Scene	---
	(OCR*4)	Similarity	Similarity	Sets the similarity of the read characters that is to be judged as OK.	0 to 100 (Defaults: lower limit: 60 upper limit: 100)	Scene	p. 146
			Stability	Sets the stability of the read characters that is to be judged as OK. If there is more than one candidate for the same character, the difference between the first and second candidates is numerically expressed by the stability.	0 to 100 (Defaults: lower limit: 10 upper limit: 100)	Scene	
			Read Char. Str L1 to Read Char. Str L4	Display the read character string.	---	Scene	
			Verif. Str L1 to Verif. Str L4	Display the verification string.	---	Scene	
			Character Count	Set the number of character that judgement is OK.	0 to 32 (Defaults: lower limit: 0 upper limit: 32)	Scene	

		Menu command	Description	Setting range	Data		
Inspection	Settings	Judgement	2D-code	Num. of char.	Displays the number of characters that were read.	---	p. 193
				Characters	Displays the character string that was read.	---	
				Overall quality	Displays the evaluation value of overall quality.	0 to 4	
				Decode	Displays the evaluation value of decode.	---	
				Cell Contrast	Displays the evaluation value of cell contrast.	---	
				Cell Modulation	Displays the evaluation value of cell modulation.	---	
				Fixed pattern damage	Displays the evaluation value of fixed pattern damage.	---	
				Axial nonuniformity	Displays the evaluation value of axial nonuniformity.	---	
				Grid nonuniformity	Displays the evaluation value of grid nonuniformity.	---	
				Unused err. Corr.	Displays the evaluation value of unused error correction.	---	
				Print scale	Displays the evaluation value of the print scale.	---	
				Print scale X	Displays the evaluation value of print scale X.	---	
				Print scale Y	Displays the evaluation value of print scale Y.	---	
				2D-code(DPM) ^{*3}	Contrast	Sets the upper and lower limits of the contrast that is to be judged as OK.	
	Focus	Sets the upper and lower limits of the focus that is to be judged as OK.	0 to 100 (Defaults: lower limit: 0 upper limit: 100)		Scene		
	Cell Recog. Rate	Sets the upper and lower limits of the cell recognition rate that is to be judged as OK.	0 to 100 (Defaults: lower limit: 0 upper limit: 100)		Scene		
	Num. of char.	Displays the number of characters that were read.	---		---		
	Characters	Displays the character string that was read.	---		---		
	Cell size	Outputs the number of pixels per cell of the scanned code.	---		---		
	Overall quality	Displays the evaluation value of overall quality.	0 to 4		---		
	Decode	Displays the evaluation value of decode.	---		---		
	Cell Contrast	Displays the evaluation value of cell contrast.	---		---		
	Cell Modulation	Displays the evaluation value of cell modulation.	---		---		
	Fixed pattern damage	Displays the evaluation value of fixed pattern damage.	---	---			
Axial nonuniformity	Displays the evaluation value of axial nonuniformity.	---	---				
Grid nonuniformity	Displays the evaluation value of grid nonuniformity.	---	---				
Unused err. Corr.	Displays the evaluation value of unused error correction.	---	---				

Menu command		Description	Setting range	Data					
Inspection	Settings	Judgement	(Search ⁺ , Shape search II ⁺ , Shape search III ⁺ , Sensitive search ⁺)	Correlation	Sets the correlation OK range.	0 to 100 (Defaults: Lower limit: 60 Upper limit: 100)	Scene	p. 218 p. 234 p. 262	
				Position X	Sets the position OK range.	(Defaults: Lower limit: -99,999.9999 Upper limit: 99,999.9999)	Scene		
				Position Y		(Defaults: Lower limit: -99,999.9999 Upper limit: 99,999.9999)	Scene		
				Density deviat. (Sensitive search only)	Set the density deviation OK range.	<ul style="list-style-type: none"> Color image Range: 0 to 221 Defaults: Upper limit: 221 Lower limit: 0 Monochrome image Range: 0 to 127 Defaults: Upper limit: 127 Lower limit: 0 	Scene		
				Angle	Sets the angle OK range.	-180 to 180 (Defaults: Lower limit: -180 Upper limit: 180)	Scene		
				Count	Sets the count OK range.	0 to 32 (Default: 0)	Scene		
				(Edge position ⁺)	Offset amount (Edge position only)	Sets the upper/lower limit range for the amount of position deviation considered to be OK.	-99,999.9999 to 99,999.9999 (Defaults: Lower limit: -1,640 Upper limit: 1,640)	Scene	p. 274
					Position X	Sets the position OK range.	-99,999.9999 to 99,999.9999 (Defaults: Lower limit: -99,999.9999 Upper limit: 99,999.9999)	Scene	
					Position Y		-99,999.9999 to 99,999.9999 (Defaults: Lower limit: -99,999.9999 Upper limit: 99,999.9999)	Scene	
				(Edge width ⁺)	Edge width	Sets the Edge width OK range.	<ul style="list-style-type: none"> When the result type is set to absolute value: Range: 0.0000 to 99,999.9999 Defaults: Upper limit: 99,999.9999, Lower limit: 0.0000 When the result type is set to relative values: Range: -99,999.9999 to 99,999.9999 Defaults: Upper limit: 99,999.9999 Lower limit: -99,999.9999 When the result type is set to ratios: Range: 0.000 to 999.9999(%) Defaults: Upper limit: 999.9999 Lower limit: 0.000 	Scene	p. 284

Menu command		Description	Setting range	Data			
Inspection	Settings	Judgement (Edge pitch* ²)	Edge pitch	Range: 0 to 1000 Defaults: Lower limit: 0 Upper limit: 1000	Scene	p. 289	
			Average pitch		Scene		
			Max. pitch (maximum pitch)		Scene		
			Min. pitch (minimum pitch)	Sets the Edge pitch OK range.	Range: 0.0000 to 99,999.9999 Defaults: Lower limit: 0.0000 Upper limit: 99,999.9999		Scene
			Average width		Scene		
			Max. width (maximum pitch)		Scene		
			Min. width (minimum pitch)		Scene		
	(Color Data* ²)	Color difference (Color images only)	Sets the upper and lower limits of the difference between the average color and reference color that is to be judged as OK.	0.0000 to 442.0000 (Defaults: Lower limit: 0 Upper limit: 442)	Scene	p. 296	
		Color deviation (Color images only)	Set the upper and lower limits of the range of the deviation in the region that is to be judged as OK.	0.0000 to 221.0000 (Defaults: Lower limit: 0 Upper limit: 221)	Scene		
		R average (Color images only)	Set the difference in the average value of the R (red) component that is to be judged as OK.	0.0000 to 255.0000 (Defaults: Lower limit: 0 Upper limit: 255)	Scene		
		G average (Color images only)	Set the difference in the average value of the G (green) component that is to be judged as OK.	0.0000 to 255.0000 (Defaults: Lower limit: 0 Upper limit: 255)	Scene		
		B average (Color images only)	Set the difference in the average value of the B (blue) component that is to be judged as OK.	0.0000 to 255.0000 (Defaults: Lower limit: 0 Upper limit: 255)	Scene		
		Density average (monochrome images only)	Sets the upper/lower limit range for the density average in the measurement region.	0 to 255 (Defaults: Lower limit: 0 Upper limit: 255)	Scene		
		Density deviat. (monochrome images only)	Sets the upper/lower limit range for the density deviation in the measurement region.	0 to 127 (Defaults: Lower limit: 0 Upper limit: 127)	Scene		
	(Area* ²)	Area	Set the upper and lower limits for an OK judgement.	<ul style="list-style-type: none"> When the result type is set to absolute value: Range: 0.0000 to 999,999,999.9999 Defaults: Upper limit: 999,999,999.9999 Lower limit: 0.0000 When the result type is set to relative values: Range: -999,999,999.9999 to 999,999,999.9999 Defaults: Upper limit: 999,999,999.9999, Lower limit: -999,999,999.9999 When the result type is set to ratios: Range: 0.0000 to 999.9999(%) Defaults: Upper limit: 999.9999 Lower limit: 0.0000 	Scene	p. 303	
		Gravity X	Set the upper and lower limits of the range of gravity X that is to be judged as OK.	Range: -99,999.9999 to 99,999.9999 Defaults: Upper limit: 99,999.9999 Lower limit: -99,999.9999	Scene		
		Gravity Y	Set the upper and lower limits of the range of the gravity Y that is to be judged as OK.	Range: -99,999.9999 to 99,999.9999 Defaults: Upper limit: 99,999.9999 Lower limit: -99,999.9999	Scene		

Menu command		Description	Setting range	Data			
Inspection	Settings	Judgement (Labeling ²)	Number of labels	Set the upper and lower limits of the number of labels for an OK judgement.	0 to 100 (Defaults: Upper limit: 100 Lower limit: 0)	Scene	p. 313
			Total label area	Set the upper and lower limits of the total label area for an OK judgement.	0 to 999,999,999.9999 (Defaults: upper limit: 999,999,999.999 lower limit: 0)	Scene	
			Area	Sets the upper and lower limits of the area for an OK judgement.	0 to 999,999,999.9999 (Defaults: upper limit: 999,999,999.999 lower limit: 0)	Scene	
			Gravity X	Set the upper and lower limits of the gravity X for an OK judgement.	-99,999.9999 to 99,999.9999 (Defaults: upper limit: 99,999.9999 lower limit: -99,999.9999)	Scene	
			Gravity Y	Set the upper and lower limits of the gravity Y for an OK judgement.	-99,999.9999 to 99,999.9999 (Defaults: upper limit: 99,999.9999 lower limit: -99,999.9999)	Scene	
			Master angle	Sets the upper and lower limits of the master angle for an OK judgement.	-180 to 180 (Defaults: upper limit: 180 lower limit: -180)	Scene	
		Result type (Except for OCR, 2D-code (DPM), Edge Pitch, and Labeling)	You can change the output form of the measurement values.	<ul style="list-style-type: none"> Absolute value (Default) Relative value Ratio (Edge Position or Area only) 	Scene	p. 218 p. 234 p. 262 p. 274 p. 284 p. 303	
		Display setting	You can change the parameters of the judgment conditions.	The names of the judgment conditions are displayed.	Scene	p. 218 p. 234 p. 262 p. 274 p. 284 p. 303	
		Auto adjustment (Except for Labeling and Edge Pitch)	Automatically adjusts the judgment parameters by using actual workpieces which are considered as good or faulty products.	<ul style="list-style-type: none"> OK Teach NG Teach 	Scene	p. 346	
		Judgment Mode (Only for OCR)	Select the Judgment mode.	<ul style="list-style-type: none"> All (Default) Individual 	Scene	p. 146	
		Verif. master data	Sets whether to verify the read character string against a character string that is registered in the master data. Sets the character string to use to verify the read character string against the master data.	<ul style="list-style-type: none"> OFF (Default) Master data 0 to 31	Scene	p. 148	

Menu command		Description	Setting range	Data					
Inspection	Settings	Verification ⁴⁾ (OCR ⁴⁾	Matching Mode	Register the loaded strings to verify with the specified string.	<ul style="list-style-type: none"> • Direct Input (Default) • Calendar Matching • Code Matching 	Scene	p. 148		
			Master data regist. (only Direct Input)	Registers a character string in the master data.	Master data 0 to 31 • OFF	Scene			
			[MENU]	Auto	Reads a character string from an input image and registers it in the master data.	---	Scene		
				Insp. region					
			Item ref.	Manual	L.1 to L.4	A character string is entered directly in the master data.	32 alphanumeric characters	Scene	p. 148
				Ref. data		Registers the immediately preceding read results as a verification character string.	---	Scene	
				L.1 verif. range to L.4 verif. range		Sets the beginning and end characters to verify.	1 to 1024 (Defaults: beginning: 1, end: 1024)	Scene	
				Copy		Copies or clears registered master data.	---	---	---
				Delete					
			Auto teach No.		Sets the character string in the master data in which to automatically register the read result for teaching from an external device.	<ul style="list-style-type: none"> • OFF • Master data 0 to 31 	Scene		
			Master data regist. (only Calendar Matching)		Registers the Master data.	---	Scene	---	
			L1 to L4		Enter the Master data.			---	
			Master data regist. (only Code Matching)		Registers the Master data.	---		---	
			Master data regist.		Registers the latest result as a verification string.	---	Scene	---	
			Verif. Line Select		Select the Line to verify.	<ul style="list-style-type: none"> • Check • Unchecked (Default) 	Scene	---	
			Partial verif L1 to L4		Set the beginning and end lines to verify.	1 to 1024 (Defaults: beginning: 1, end: 1024)	Scene	---	

Menu command		Description	Setting range	Data						
Inspection	Settings	Verification ⁴ (Bar code ³ , 2D-code ³ , 2D-code (DPM) ³)	Verif. master data	<ul style="list-style-type: none"> • OFF • All master data (Default) • Master data 0 to 31 	Scene	p. 182 p. 194 p. 207				
			Master data regist.	Registers a character string in the master data.	Master data 0 to 31		Scene			
			[MENU]	Auto	Reads a character string from an input image and registers it in the master data.		---	Scene		
				Insp. region						
			Manual	L. 1 to L. 4	Registers a character string directly in the master data.		32 alphanumeric characters	Scene		
			Item ref.	Ref. data	Registers the immediately preceding read results as a verification character string.		---	Scene		
				Line 1 verif. range to Line 4 verif. range	Sets the beginning and end characters to verify for each line.		1 to 1024 (Defaults: beginning: 1 end: 1024)	Scene		
			Copy	Copies or clears registered master data.			---	---		
			Delete							
			Details	(OCR ⁴)	Meas. Parameter		Same as [Teach] – [Meas. Parameter] under [Modify] or [Inspection].		Scene	p. 156
					Dictionary param.		Sets the model dictionary to register custom characters.	---	Scene	
					Dictionary ref.		Sets the dictionary data to use for character recognition.	<ul style="list-style-type: none"> • None (Default) Dictionary data 0 to 31	Scene	
Individual char.	When you have number, alphabet, or symbol that want to exclude, touch Individual char, and then unchecked the attempt character,	---			Scene					
Number		0 to 9								
Alphabet		A to Z								
Symbol		: (colon) / (slash) () (parentheses)			p. 169					
Date Parameters										
Period Setting	Year	Set the period setting of the current date and time.			0 to 99 (Default: 0)	Scene				
	Month				0 to 99 (Default: 0)					
	Day		-999 to 999 (Default: 0)							

Menu command		Description	Setting range	Data				
Inspection	Details (OCR)*4	Date Parameters						
		Date Setting	Zero Suppress	Select the method for Zero Suppress.	<ul style="list-style-type: none"> • 0 (Default) • Blank 			
			Date Calc. Order	Select the calculate method when the Period Setting is set,	<ul style="list-style-type: none"> • Month → Day (Default) • Day → Month 			
			Month end adjust	Select the adjust method when not exist day is calculated.	<ul style="list-style-type: none"> • Last day of current month (Default) • First day of next month • Gap day of next month 			
		Common Setting	Auto Update	Set the Update method.	<ul style="list-style-type: none"> • Don't Update • Fist Update • Always Update (Default) 	Scene	p. 159	
			Back Margin	Set the Time Margin that is before the current time.	0 to 99 (Default: 0)			
			Ahead Margin	Set the Time Margin that is after the current time.	0 to 99 (Default: 0)			
		Code data						
		Output parameter	File name	Displays the file name of code data.		Scene		
			Reflect	Specifies whether to reflect the judgment results of an inspection item in the overall judgment.	<ul style="list-style-type: none"> • Yes (Default) • No 	Scene	p. 146	
			Error string	Sets the character string that is output for read errors.	20 alphanumeric characters (Default: NG)	Scene	p. 158	
		(Bar code)*3	Meas. Parameter	Same as [Teach] – [Meas. Parameter] under [Modify] or [Inspection].		Scene	p. 186	
			Output parameter	Reflect	Specifies whether to reflect the judgment results of an inspection item in the overall judgment.	<ul style="list-style-type: none"> • Yes (Default) • No 	Scene	p. 185
				Error string	Sets the character string that is output for read errors.	20 alphanumeric characters (Default: NG)	Scene	p. 187
			Meas. Parameter	Same as [Teach] – [Meas. Parameter] under [Modify] or [Inspection].		Scene	p. 196	
	Output parameter		Reflect	Specifies whether to reflect the judgment results of an inspection item in the overall judgment.	<ul style="list-style-type: none"> • Yes (Default) • No 	Scene	p. 196	
			Error string	Sets the character string that is output for read errors.	20 alphanumeric characters (Default: NG)	Scene	p. 198	
	(2D-code)*3	Meas. Parameter	Same as [Teach] – [Meas. Parameter] under [Modify] or [Inspection].		Scene	p. 210		
		Output parameter	Reflect	Specifies whether to reflect the judgment results of an inspection item in the overall judgment.	<ul style="list-style-type: none"> • Yes (Default) • No 	Scene	---	
			Error string	Sets the character string that is output for read errors.	20 alphanumeric characters (Default: NG)	Scene	p. 212	
			Error string	Sets the character string that is output for read errors.	20 alphanumeric characters (Default: NG)	Scene	p. 212	

Menu command		Description	Setting range	Data			
Inspection	Details (Search*)	Model parameter	Rotation	Sets the angle range for the registered model.	<ul style="list-style-type: none"> No (Default) Yes 	Scene	p. 222
			Angle range		-180 to 180 (Defaults: Lower limit: -180 Upper limit: 180)	Scene	p. 222
			Stability	Sets whether priority is given to measurement stability or speed.	1 to 15 (Default: 12)	Scene	p. 223
			Accuracy	Sets whether priority is given to measurement position accuracy or speed.	1 to 3 (Default: 2)	Scene	p. 223
		Meas. Parameter	Sub-pixel	You can increase the accuracy of measurement positioning.	<ul style="list-style-type: none"> No (Default) Yes 	Scene	p. 219
			Meas. Parameter	Extraction condition			Scene
		Candidate level		Sets the detection target to only objects with a correlation above the specified candidate level.	0 to 100 Default: 80	Scene	
		Extraction X		Results are output only for objects with a measured X coordinate that is within this range.	-999,999,999.9999 to 999,999,999.9999 (Defaults: Lower limit: -999,999,999.9999 Upper limit: 999,999,999.9999)	Scene	p. 221
		Extraction Y		Results are output only for objects with a measured Y coordinate that is within this range.	-999,999,999.9999 to 999,999,999.9999 (Defaults: Lower limit: -999,999,999.9999 Upper limit: 999,999,999.9999)	Scene	
		Detection count		Sets the maximum number of detection results to output.	1 to 32 Default: 32	Scene	
		Output parameter	Multi-point output	Sets whether to output only the result with the highest correlation, or to output all results that meet the specified extraction conditions.	<ul style="list-style-type: none"> ON (Default) OFF 	Scene	p. 221
			Sorting method	Sets the sort condition to use when multiple measurement results meet the extraction conditions.	<ul style="list-style-type: none"> Corr. ascending order Corr. descending order (Default) Pos.X ascending order Pos.X descending order Pos.Y ascending order Pos.Y descending order 	Scene	p. 220
			Reflect	You can specify whether to reflect the measurement results of an inspection item in the overall judgement.	<ul style="list-style-type: none"> None Yes (Default) 	Scene	p. 222

Menu command		Description	Setting range	Data		
Inspection	Details	Model parameter	Rotation (Only for Shape Search III)	<ul style="list-style-type: none"> No Yes (Default) 	Scene	p. 238
			Angle range	Sets the angle range for the registered model. -180 to 180 (Defaults: Lower limit: -180 Upper limit: 180)	Scene	p. 238
	(Shape search II*2 Shape search III*2)	Meas. Parameter	Model mode	You can change to a mode that makes it easier to search for images similar to a model. <ul style="list-style-type: none"> Fast Stable (Default) 	Scene	p. 223
			Extraction condition		Scene	
			Candidate level	Sets the detection target to only objects with a correlation above the specified candidate level. 0 to 100 Default Shape Search II: 80 Shape Search III: 50	Scene	
			Extraction X	Results are output only for objects with a measured X coordinate that is within this range. -999,999,999.9999 to 999,999,999.9999 (Defaults: Lower limit: -999,999,999.9999, Upper limit: 999,999,999.9999)	Scene	p. 237
			Extraction Y	Results are output only for objects with a measured Y coordinate that is within this range. -999,999,999.9999 to 999,999,999.9999 (Defaults: Lower limit: -999,999,999.9999, Upper limit: 999,999,999.9999)	Scene	
		Detection count	Sets the maximum number of detection results to output. 1 to 32 Default : 1	Scene		
		Sorting method	Sets the sort condition to use when multiple measurement results meet the extraction conditions.. <ul style="list-style-type: none"> Corr. ascending order Corr. descending order (Default) Pos.X ascending order Pos.X descending order Pos.Y ascending order Pos.Y descending order 	Scene	p. 235	
		Overlay Judgment (only for Shape Search III)	When you want to find the detected result when the detected result is overlapped, set this parameter to ON. <ul style="list-style-type: none"> ON OFF (Default) 	Scene	p. 236	
		Overlay Rejection (only for Shape Search III)	Set the range to remove overlapped target. 0 to 100 (Default: 100)	Scene		
		Edger level auto (only for Shape Search III)	The [Edge level] can be set automatically by selecting ON. If edge recognition results are not good with this setting, set to OFF. <ul style="list-style-type: none"> ON (Default) OFF 	Scene		
	Output parameter	Edge level (only for Shape Search III)	This function will be enabled if you uncheck [Auto] check box. Set the lower limit to recognize the [Edge level]. Edges higher than set value are recognized. Decrease the setting value when it is difficult to find edges. Increase the setting value when the effect of noise is high. 0 to 1024 (Default: 70)	Scene	p. 239	
		Acceptable Dist. Level (only for Shape Search III)	Set the acceptable level of distortion. <ul style="list-style-type: none"> Low Medium High 	Scene	p. 240	
		Reflect	You can specify whether to reflect the judgement results of an inspection item in the overall judgement. <ul style="list-style-type: none"> No Yes (Default) 	Scene	p. 238	

Menu command		Description	Setting range	Data				
Inspection	Details (Sensitive search ^{*2})	Model parameter	Rotation	<ul style="list-style-type: none"> No (Default) Yes 	Scene	p. 266		
			Angle range	Sets the angle range for the registered model.	-180 to 180 (Defaults: Lower limit: -180 Upper limit: 180)	Scene	p. 266	
		Model parameter	Sub-model number	You can change the number of divisions of the registered model.	<ul style="list-style-type: none"> 3 × 3 5 × 5 (Default) 9 × 9 	Scene	p. 265	
			Plain inspection	Enables or disables inspecting plain sections.	<ul style="list-style-type: none"> Yes No (Default) 	Scene	p. 214	
			Sub-pixel	You can increase the accuracy of measurement positioning.	<ul style="list-style-type: none"> No (Default) Yes 	Scene	p. 264	
		Meas. Parameter	Candidate level	Sets the detection target to only objects with a correlation above the specified candidate level.	0 to 100 (Default: 70)	Scene	p. 264	
			Output parameter	Reflect	You can specify whether to reflect the judgement results of an inspection item in the overall judgement.	<ul style="list-style-type: none"> No Yes (Default) 	Scene	p. 263
		(Edge width ^{*2} , Edge position ^{*2} , Edge pitch ^{*2})	Meas. Parameter	Edge level (Color image only)	Sets the color density level of the edge.	<ul style="list-style-type: none"> Color difference (%): 0 to 100 (Default: 50) Color difference: 0 to 442 (Default: 20) 	Scene	p. 275 p. 266 p. 276
				Noise level (Color image only)	Sets the color density level to treat as noise.	0 to 442 (Default: 5)	Scene	p. 275 p. 266 p. 276
				Measurement method (monochrome image only)	Specifies the edge detection method.	<ul style="list-style-type: none"> Projection (Default) Differentiation 	Scene	p. 275 p. 266 p. 276
	Output parameter		Density change (monochrome image only)	Specifies the density direction that is detected.	<ul style="list-style-type: none"> Light to Dark (Default) Dark to Light 	Scene	p. 275 p. 266 p. 276	
			Edge level (monochrome image only)	Specifies the density level that is regarded as an edge.	Density diff. (%): 0 to 100 (Default: 50) Density diff.: 0 to 255 (Default: 20)	Scene	p. 275 p. 266 p. 276	
			Noise level (monochrome image only)	Specifies the density change level that is regarded as an edge.	0 to 255 (Default: 5)	Scene	p. 275 p. 266 p. 276	
			Reflect	You can specify whether to reflect the judgment results of an inspection item in the overall judgment.	<ul style="list-style-type: none"> No Yes (Default) 	Scene	p. 275 p. 266 p. 276	
	(Color Data ^{*2})	Output parameter	Reflect	You can specify whether to reflect the judgement results of an inspection item in the overall judgement.	<ul style="list-style-type: none"> No Yes (Default) 	Scene		

Menu command		Description	Setting range	Data			
Inspection	Details (Area*2)	Meas. Parameter Fill profile	You can set how to process holes for an Area inspection item.	<ul style="list-style-type: none"> None (Default) Filling up holes Fill Outline 	Scene	p. 308	
		Output parameter Reflect	You can specify whether to reflect the judgement results of an inspection item in the overall judgement.	<ul style="list-style-type: none"> No Yes (Default) 	Scene	p. 319	
	(Labeling*2)	Meas. Parameter	Filling up holes	Sets how to process areas surrounded by the specified color.	<ul style="list-style-type: none"> Yes No (Default) 	Scene	p. 308
			Extract image	Select this option if there are areas of the specified color inside the measurement region that you do not want to measure.	<ul style="list-style-type: none"> Yes No (Default) 	Scene	p. 317
		Extraction condition			Scene	p. 317	
		Number of labels	Set the maximum number of labels to detect.	Range: 1 to 100 Default: 100	Scene		
		Area	Specify the area range to judge as a label.	Range: 0 to 999,999,999.9999 (Defaults: Lower limit: 0 Upper limit: 999,999,999.9999)	Scene		
		Gravity X	Specify the gravity X position to judge as a label.	Range: -99,999,999.9999 to 999,999,999.9999 (Defaults: Lower limit: 0 Upper limit: 999,999,999.9999)	p. 218		
			Gravity Y	Specify the gravity Y position to judge as a label.		Range: -999,999,999.9999 to 999,999,999.9999 (Defaults: Lower limit: 0 Upper limit: 999,999,999.9999)	
	Sorting method	Set the condition to use for label number reassignment.	Area ascending order Area descending order (Default) Pos. X ascending order Pos. X descending order Pos. Y ascending order Pos. Y descending order	Scene	p. 319		
	Output parameter	Reflect	You can specify whether to reflect the judgement results of an inspection item in the overall judgement.	<ul style="list-style-type: none"> No Yes (Default) 	Scene	p. 319	

Menu command		Description	Setting range	Data			
Calculation	Settings	Expression [MENU]	Expression 0 to expression 31	Sets the number of the expression for which to set a calculation.	---	Scene	p. 323
			Expression settings	Sets the expressions.	---	Scene	
			Data	Uses the measurement result of other items.	Inspection item calculation symbols () / * . , + TJG	Scene	p. 330
			Const.	Inputs constants or mathematical operators.	0 to 9, .. calculation symbol () / * ? , + TJG	Scene	p. 330
			Math.	Uses functions in expressions.	SIN, COS, ATAN, AND, OR, NOT, ABS, MAX, MIN, MOD, SQRT, ANGL (angle of straight line joining two points (center of gravity and model center)), DIST (distance between two points), calculation symbols () / * . , + TJG	Scene	p. 330
			Rename	Deletes/copies the expression or changes the expression name.	---	Scene	p. 330
			Copy		---	---	
	Delete	---	---				
		Judgement	Specifies the parameters for judgment of results.		Scene	p. 323	
		Details	Output parameter	Reflect	You can specify whether to reflect the judgment results of a calculation in the overall judgment.	<ul style="list-style-type: none"> No Yes (Default) 	Scene
Retry details	Max Count (Normal retry)		Sets the number of retries.	0 to 20 Default: 4	Scene	---*1	
	Interval (Normal retry)		Sets the retry interval (msec).	32 to 999 Default: 100	Scene		
	Brightness step or Shutter speed step (Exposure retry)		Sets the exposure time step (msec).	<ul style="list-style-type: none"> Brightness step: 1 to 20, Default 5 shutter speed step: 0.01 to 1.00 (Default: 0.30) 	Scene		
	Increment count (Exposure retry)		Sets the increment count for the brightness (shutter speed) step.	0 to 10 (Default: 2)	Scene		
	Decrement count (Exposure retry)		Sets the decrement count for the brightness (shutter speed) step.	0 to 10 (Default: 2)	Scene		

*1 Refer to FQ2-S/CH Series User's Manual for Communications Settings (Cat. No. Z338).

*2 Not supported on the FQ2-CH Series.

*3 Not supported on the FQ2-S1/S2/S3 Series or FQ2-CH Series.

*4 Not supported on the FQ2-S1/S2/S3 Series.

In/Out Tab Page

Menu command		Description	Setting range	Data						
Log setting	Statistical data		Sets whether to record the number of measurements and the number of NG overall judgments.	<ul style="list-style-type: none"> • ON (Default) • OFF 	System	p. 402				
	Image logging		Sets the parameter to log measurement image data.	<ul style="list-style-type: none"> • All • Only NG • None (Default) 	System	p. 395 p. 402				
	Data logging	Condition	Sets the parameter to log measurement data from inspection items.	<ul style="list-style-type: none"> • All • Only NG • None (Default) 	System	p. 395				
		Select data	You can select the parameters to log from the parameters in the filter items, position compensation items, inspection items and expression that are set.	Parameter names for the filter items position compensation items, inspection items and expression that are set	System	p. 396				
	Delete Log		Resets the log data without turning OFF the power supply.	---	---	p. 403				
I/O setting	I/O setting	Output	Control signal	Specify the output signal to OUT0 to OUT2.	<ul style="list-style-type: none"> • OR (Total judgement (Default assignment: OUT0)) • BUSY • ERROR (Default assignment: OUT2) • READY (Default assignment: OUT1) • RUN • STG 	System	---*1			
								Item judgement	When model FQ-SDU is connected, OUT0 to OUT2 are not displayed.	OR0 (Item0 judgement) to OR31 (Item31 judgement)
								Expression judgement		Exp.0 judgement to EXP. 31 judgement
	OR output		OK: ON NG: ON (Default)		System	---*1				
	Output mode		You can set the output mode for the OR signal and for output signals to which judgements are assigned.	<ul style="list-style-type: none"> • One-shot output • Level output (Default) 	System	---*1				
	Output delay		When one-shot output mode is selected, this parameter sets the delay from when measurement processing is completed until when the OR signal turns ON.	0 to 1,000 ms (Default: 0 ms)	System	---*1				
	Output time		When one-shot output mode is selected, this parameter sets the time that the OR signal is ON.	1 to 1,000 ms (Default: 5 ms)	System					
	BUSY output		Specifies when to turn OFF the BUSY signal after starting measurement processing.	<ul style="list-style-type: none"> • Measurement (Default) • Data logging • Image logging • Result display 	System	---*1				

Menu command		Description	Setting range	Data			
I/O setting	I/O setting	Output	OUT0 Polarity	You can change the polarity of the output signals that are assigned to OUT0 to OUT2 (regardless of what signal is assigned to the output). When FQ-SDU is connected, OUT0 to 2 will not appear.	<ul style="list-style-type: none"> • Positive (Default) • Negative 	System	---*1
			OUT1 Polarity		<ul style="list-style-type: none"> • Positive (Default) • Negative 	System	
			OUT2 Polarity		<ul style="list-style-type: none"> • Positive (Default) • Negative 	System	
			BUSY LED		You can change the BUSY indicator to a RUN indicator.	<ul style="list-style-type: none"> • BUSY (Default) • RUN 	System
			Output control	You can select the data output method. (Only when the FQ-SDU1□ is connected.)	<ul style="list-style-type: none"> • None (Default) • Handshaking • Sync. Output 	System	---*1
			Output period	Sets the period for outputting measurement results. (Only when the FQ-SDU1□ is connected.)	2.0 to 5,000.0 ms 10.0 ms (Default)	System	---*1
			GATE ON delay	Sets the time from when the result is output to the parallel interface until the GATE signal turns ON. (Only when the FQ-SDU1□ is connected.)	1.0 to 1,000.0 ms 1.0 ms (Default)	System	---*1
			Output time	Sets the time to turn ON the GATE signal. (Only when the FQ-SDU1□ is connected.)	1.0 to 1,000.0 ms 5.0 ms (Default)	System	---*1
			Timeout	Sets the timeout time for output control. (Only when the FQ-SDU1□ is connected.)	0.5 to 120.0 s 10.0 s (Default)	System	---*1
			Number of delay	Set the number of times to ignore the TRIG signal turning ON between when the TRIG signal turns ON and the measurement results are output. (Only when the FQ-SDU1□ is connected.)	1 (Default) to 15	System	---*1
			ACK signal ON period	Sets the output time of the normal execution completion signal for parallel commands. (Only when the FQ-SDU is connected.)	1.0 to 1,000.0 ms 5.0 ms (Default)	System	---*1
			Output polarity	Sets the ON/OFF polarity for all of the output signals (Only when the FQ-SDU is connected.)	<ul style="list-style-type: none"> • Positive (Default) • Negative 	System	---*1
		Input	Input mode	Specifies whether to use functions other than scene switching for external parallel commands.	<ul style="list-style-type: none"> • Standard mode (Default) • Expanded mode 	System	---*1
Output data setting	Noprotocol data output	[MENU]	Output data set	---	Data 0 to data 31	Scene	---*1
			Data settings	Sets data to output to selected data number.	Text strings for the filter items, position compensation items, inspection items and expression that are set	Scene	
			Multi-data setting			Scene	
			Rename	Changes the name of the selected data number.	The name can be changed to a name with up to 15 alphanumeric characters.	Scene	
			Copy	Copies the contents registered in the selected data number to another data number.		Scene	
			Delete	Clears the content of the selected data number.		Scene	

Menu command		Description	Setting range	Data				
I/O setting	Output data setting	Output character set	Specifies the output settings for characters read by OCR, Bar code, 2D-code, and 2D-code (DPM).	---	---	---*1		
		String output on/off	Selects whether the string that was read is output.	<ul style="list-style-type: none"> • ON • OFF (Default) 	Scene			
		Partial output on/off	Selects whether part of the string is to be specified for output.	<ul style="list-style-type: none"> • ON • OFF (Default) 	Scene			
		Output string setup	Species the part of the string that is output.	1 to 1024 (Defaults: beginning: 1, end: 1024)	Scene			
		NG String output on/off	Specifies whether NG strings are output.	<ul style="list-style-type: none"> • ON • OFF (Default) 	Scene			
	Output form		---	---	---	---*1		
	Output form (No-Protocol (TCP) and No-Protocol (UDP) only)		Selects the format of the data to be output.	<ul style="list-style-type: none"> • ASCII (Default) • Binary 	Scene	---*1		
	When output format is ASCII	Digits of integer	<p>Sets the digits of the integer part, including the sign. However, + is not output for positive numbers.</p> <p>Example: Setting 4-digit data: -5963 is output as -999.</p>	1 to 10 (Default: 6)	Scene			
		Digits of decimal	Sets the output digits for the decimal part. If it is set to 0, the decimal part is rounded off before the data is output.	0 to 4 (Default: 4)	Scene			
		Negative	Selects what to display as the sign when the number is negative.	<ul style="list-style-type: none"> • - (Default) • 8 	Scene			
		0 suppress	<p>Selects the method to adjust unused digits on the left in output data.</p> <p>Example: The following examples are for when five integer digits and three decimal digits are set and the data is 100.000. ON: 00100.000 OFF: _100.000 (The underscore indicates a space.)</p>	<ul style="list-style-type: none"> • ON • OFF (Default) 	Scene			
	Noprotoal data output	Output form	Field separator	When Output Format is ASCII	Selects the separator to use between output data.	<ul style="list-style-type: none"> • None (Default) • comma • tab, space • CR • LF • CR+LF 	Scene	---*1
					Record separator	Selects the separator to use between sets of output data.	<ul style="list-style-type: none"> • None (Default) • comma • tab space • CR • LF • CR+LF 	
		When output format is Binary	Decimal output form	Selects the numerical expression for binary output. Fixed-decimal-point data is multiplies by 1,000 and the result is output.	Floating-point decimal or fixed decimal (Default)	Scene	---*1	
				Output form (No-Protocol (TCP) and No-Protocol (UDP) only)	Sets whether to output the data.	<ul style="list-style-type: none"> • Floating-point decimal • Fixed decimal (Default) 		Scene

Menu command		Description	Setting range	Data			
I/O setting	Output data setting Link data / Fieldbus data output	Output data set	The same as for no-protocol data output, above.	Scene	---*1		
		Output character set		Scene			
		Output format		Scene			
Par. Jdg Output(Only when the FQ-SDU1□ is connected.)	Basic	Settings	---	Data0 to Data15	Scene		
		Settings	Sets the data from the inspection item to judge.	Inspection item text strings	Scene		
		Rename	Changes, copies, or clears the data.	---	Scene		
		Copy			Scene		
	Delete	Scene					
	Judgement condition	Data 0 to Data 15	Sets the range of the output data to judge OK.	Range: -999,999,999.9999 to 999,999,999.999 Defaults: Upper limit: 999,999,999.999 Lower limit: -999,999,999.9999	Scene	---*1	
	Details	Output parameter	Reflect	You can specify whether to reflect the judgment results of an inspection item in the overall judgment.	<ul style="list-style-type: none"> No Yes (Default) 	Scene	---*1
		Data output	Data output	Sets whether to output the judgment results.	<ul style="list-style-type: none"> No Yes (Default) 	Scene	---*1
	Par. Data Output (Only when the FQ-SDU1□ is connected.)	Basic	Data settings	---	Data0 to Data31	Scene	
			Data settings	Sets the output data.	Inspection item text strings	Scene	
Rename			Changes, copies, or clears the data.	---	Scene		
Copy					Scene		
Delete		Scene					
Output format		Output format	Sets the output form.	Binary(Default) or BCD	Scene	---*1	
Output parameter		Data output	Output form	Sets whether to output the data.	<ul style="list-style-type: none"> No Yes (Default) 	Scene	---*1
I/O monitor		Used to check I/O connections.	---	---	p. 385		

*1 Refer to FQ2-S/CH Series User's Manual for Communications Settings (Cat. No. Z338).

Test Tab Page

Menu command	Description	Setting range	Data					
Continuous test	Used to check the individual judgment results for the inspection items and to adjust the judgment parameters.							
	Graphic	Displays the input image.		p. 340				
	Graphics + Details	Displays the inspection item individual judgment results and measurement values.						
	All results/Region	Displays the inspection item individual judgment results for all inspection items.	---	---	p. 349			
	Trend Monitor	Displays the individual judgment results saved in the Sensor in a trend monitor.			p. 340 p. 358			
	Histogram	Displays the individual judgment results saved in the Sensor in a histogram.						
	Model region	Same as for the Search item settings.		Scene	---			
			Insp. region	Scene				
	Adjust judgement	Adjusts judgment parameters without stopping measurements.	---		p. 346			
	Result type	Specifies the measurement result type.	<ul style="list-style-type: none"> • Absolute value (Default) • Relative value • Ratio 	Scene	p. 346			
Continuous test		Specifies whether to display individual inspection results.	<ul style="list-style-type: none"> • Area, Labeling • Measurement image • All color image (Default) • Selected color image • Binary image • When the Shape Search III.. <ul style="list-style-type: none"> • Meas. Img. • Meas. Img.+Model Img. • Edge Image • Edge Img.+ Model Img. 	Scene	p. 346			
				Auto judgement condition setting	Automatically adjusts the judgment parameters by using actual workpieces which are considered as good or faulty products.	<ul style="list-style-type: none"> • OK Teach • NG Teach 		
				Method	Selects the expression to use to automatically adjust the judgment parameters.	<ul style="list-style-type: none"> • Threshold (minimum) • Threshold (average) (Default) • Threshold (maximum) 		
				Auto display (trend monitor and histogram only)				
				Display range (trend monitor and histogram only)	Same as the trend monitor and histogram for [Run] Mode.		---	p. 358 p. 360
				Number of data (trend monitor only)				p. 358
				Number of data (histogram only)				p. 360
				Erase display				---
				Save data	Saves scene data, Calibration data, and system data.	---	---	p. 350

Run Tab Page (from Setup Display)



Menu command	Description	Setting range	Data	
Switch to Run mode	Switches to Run Mode.	---	---	p. 353

Tool

Setup Mode

Menu command	Description	Setting range	Data			
Select scene		---	---	p. 366		
Select	Switches to a registered scene.	---	Scene			
Rename	Used to delete, copy, or change the name of a scene.	15 alphanumeric characters	---			
Copy		---				
Clear						
Calibration*2	Select	Sets a registered calibration pattern.	Calibration data 0 to 31	---		
	Modify	Used to edit calibration data.	Calibration data 0 to 31	Calibration data		
	Specify point	Sets the type of calibration data to set.	Specify point (No. 1 to No. 9)	---	p. 371	
	Reference			---	p. 374	
	Parameter			---	p. 377	
	Modify	Sets the parameters for the calibration data.	---	---	---	
	(Specify point)	Specify point coord.	Sets the Camera coordinates.	---	Calibration data	
	Actual coord.					
	Generate parameters	Actual coord.	Sets the Camera coordinates and the actual coordinates.	Point coordinate: 0 to 9999 Actual coordinate: 0 to 99999.9999	Calibration data	p. 371
		Generate parameters	Used to create calibration parameters.	---	Calibration data	

Menu command		Description	Setting range	Data			
Calibration*2	 	(Reference sampling)	Model region	Used to edit the model regions. The procedure is the same as for setting the model region for a Search inspection item.	---	Calibration data	p. 374
		Insp. region	Changes the size and position of the measurement region.	---	Calibration data		
		Actual coord.	Sets the Camera coordinates and the actual coordinates.	Point coordinate: 0 to 9999 Actual coordinate: 0 to 99999.9999	Calibration data		
	(Reference sampling)	Generate parameters	Used to create calibration parameters.	---	Calibration data	p. 374	
	(Parameter)	Coordinate	Sets the positive direction when specifying coordinates.	<ul style="list-style-type: none"> • Righthand • Lefthand (Default) 	Calibration data	p. 377	
		Origin	Select the location of the origin of the coordinate system.	<ul style="list-style-type: none"> • Lowerleft • Upperleft (Default) • Center 	Calibration data		
		Magnification	Set the actual dimension that corresponds to one pixel.	0.0001 to 9.9999 (Default:1.0000)	Calibration data		
	Clear		Clears the parameter settings for the calibration data.	---	---	---	
	Copy		Copies the calibration data.	---	---	---	
	Rename		Changes the name of the calibration data.	15 alphanumeric characters max.	Calibration data	---	
Model dictionary*2	Dictionary data 0 to 31 [MENU]	Modify	Used to edit the dictionary data in the model dictionary for character recognition using custom characters.	---	Dictionary data	p. 175	
		Rename	Changes the name of dictionary data.	15 characters max.	Dictionary data		
		Copy	Copies dictionary data.	---	---		
		Clear	Clears the settings of dictionary data.	---	---		
Save to file	Setting	Scene data	Saves scene data with an SCN file name extension.	---	---	p. 406	
		Scene group data	Saves all scene data with an SGP file name extension.				
		Calibration data	Saves calibration data with an CLB file name extension.				
		Calibration group data	Saves calibration group data with an CGP file name extension.				
		Dictionary data*2	Saves dictionary data with a DIC file name extension.				
		All dictionary data*2	Saves all dictionary data with a DGP file name extension.				
		Code data*2	Saves all dictionary data with a DGP file name extension.				
Sensor system data	Saves system data with csv file name extension.						

Menu command		Description	Setting range	Data		
Save to file	Setting	All Sensor data	Saves all Sensor data with a BKD file name extension.	---	---	p. 406
		Touch Finder data	Saves Touch Finder data with an MSD file name extension.			
	Logging	Statistical data	Saves statistical data with a CSV file name extension.			p. 403
		Logging image	Saves image data with an IFZ file name extension.			
		Logging data	Saves measurement data with a CSV file name extension.			
Load from file	Scene data		Loads scene data.	---	---	p. 408
	Scene group data		Loads scene group data.			
	Calibration data		Loads calibration data.			
	Calibration group data		Loads calibration group data.			
	Dictionary data*2		Loads dictionary data.			
	All dictionary data*2		Loads all dictionary data.			
	Code data*2		Loads all dictionary data with .csv file name extension.			
	Sensor system data		Loads system data.			
	All Sensor data		Loads all Sensor data.			
	Touch Finder data		Loads Touch Finder data.			
Sensor settings	Information		Used to check the Sensor information.	---	---	System ---*1
	Model		Used to check the model and software version of the connected Sensor.	---	---	
	Version					
	Name		Displays the name of the connected Sensor.			
	MAC address		Used to check the MAC address of the connected Sensor.	---		
		Rename	Used to change the name of a connected Sensor.	15 alphanumeric characters max.	---	p. 367
		Memory state	Used to check the status of Sensor memory.	---	---	p. 367
	Error history	View history	Displays a history of errors that have occurred in the Sensor.	---	---	p. 433
		Delete history	Deletes the error history.		---	---
	Startup settings	Startup mode	Sets whether the startup scene number is set manually.	<ul style="list-style-type: none"> • ON • OFF (Scene number when settings were saved is startup scene number.)	System	p. 368
		Startup scene	Set the scene number to use at startup.	<ul style="list-style-type: none"> • Standard models: 0 to 31 • Single-function models: 0 to 7 Default: 0		
	Sensor Day/Time					
	Current Day/Time		Confirms the current day and time information of Sensor.		System	p. 167
Auto-Sync with TF		Synchronizes automatically the day and time setting of TouchFinder when the TouchFinder is connected.	<ul style="list-style-type: none"> • ON • OFF (Default) 			

Menu command		Description	Setting range	Data			
Sensor settings	Password settings	Password ON/OFF	Enables (ON) or disables (OFF) the password.	<ul style="list-style-type: none"> • OFF (Default) • ON 	System	p. 413	
		Enter password	Sets a password.	15 characters max.			
	Timeout* ²		Sets the timeout time during measurements.	100 to 30,000 ms (Default: 30,000 ms)	System	p. 367	
	Measurement retry* ²	Retry mode		Sets the type of retry for measurements.	<ul style="list-style-type: none"> • Normal retry • Expose retry • Scene retry • Trigger retry • None (Default) 	System	p. 422
		Switch Order (for Scene retry only)		Sets the method for changing scenes.	<ul style="list-style-type: none"> • Auto (Default) • Fixed 	System	p. 425
Retry scene (for Scene retry only)		Changes the order in which to change the scenes. Scenes are registered in order from the first scene.	1st to 32nd	System			
Adjustment mode in Run		Sets whether to adjust measurement contents in Run Mode.	<ul style="list-style-type: none"> • OFF (Default) • ON 	System	p. 362		
Network settings	Ethernet					p. 67	
	IP address setting		Sets the method to use to set IP addresses.	<ul style="list-style-type: none"> • Auto (Default) • Fixed • DHCP 	System		
	IP address		Enter the IP address of the Sensor. (Valid only when the [IP address setting] is set to [Fixed].)	a.b.c.d a: 1 to 223 b: 0 to 255 c: 0 to 255 d: 2 to 254 (Default: 10.5.5.100)	System		p. 67
	Subnet mask		Inputs the subnet mask. (Valid only when the [IP address setting] is set to [Fixed].)	0.0.0.0 to 255.255.255.255 (Default: 255.255.255.0)	System		p. 67
	Gateway		Sets the Default gateway address. (When the [IP address setting] is set to [Fixed].)	1.0.0.1 to 223.255.255.254 (Default: 10.5.5.1)	System		
Data output	No-protocol data	Communication type		Sets the communications type to use to output no-protocol data.	No protocol (TCP) (Default) No protocol (FINS/TCP) No protocol (RS-232C)* No-protocol (UDP) * Displays by connecting FQ-SDU□□ Sensor Data Unit.	System	...* ¹
		When the communications type is TCP no-protocol, FINS/TCP no-protocol or UDP No-protocol					
		Connection mode		Sets whether to communicate with the communications devices as a server device or a client device. * Cannot be specified when the communication type is no-protocol (UDP).	<ul style="list-style-type: none"> • TCP server (Default) • TCP client 	System	...* ¹
		IP address		Sets the IP address to which to output no-protocol data. *Setting is not possible if the connection mode is set to a TCP server.	a.b.c.d a: 1 to 223 b: 0 to 255 c: 0 to 255 d: 1 to 254 (Default:10.5.5.111)	System	...* ¹
		Output port No.		Sets the output port number. * Setting is not possible if the connection mode is set to a TCP server.	0 to 65535 (Default: 9876 (FINS/TCP) 9600 No-protocol (UDP))	System	...* ¹
		Input port No.		Sets the input port number.	0 to 65535 (Default: 9876 (FINS/TCP) 9600 No-protocol (UDP))	System	...* ¹

Menu command		Description	Setting range	Data			
Sensor settings	Data output	No-protocol data	When the communications type is RS-232C no-protocol				
			Baud rate	Set the baud rate to use for RS-232C communications.	2400, 4800, 9600, 19200, 38400, 57600, or 115200 (Default: 38400)	System	---*1
			Data length	Sets the data length.	<ul style="list-style-type: none"> 7bit 8bit (Default: 8bit) 	System	---*1
			Parity	Sets the parity.	None Odd Even (Default: None)	System	---*1
			Stop bit	Sets the number of stop bits.	1bit 2bit (Default: 1bit)	System	---*1
			Flow control	Sets the controls for the flow of communications with the software.	None Xon/Xoff (Default: None)	System	---*1
		Delimiter	Set the delimiter to add to the end of commands and responses.	CR LF CR+LF (Default:CR)	System	---*1	
		When the communications type is RS-232C no-protocol	Interval timeout (text)	Timeout [s] Set the time in seconds to generate a timeout error.	1 to 120 s, 0: Not monitored. (Default: 0 s)	System	---*1
			Interval timeout(after Xoff reception)	Timeout [s] Set the time in seconds to generate a timeout error.	1 to 120 s, 0: Not monitored. (Default: 0 s)	System	---*1
		Link data output	Communication type	Sets the communications type to use for EtherNet/IP outputs.	Invalid (Default) PLC link (SYSMAC) PLC link (MELSEC)	System	---*1
				Area settings(Only when communications type is PLC Link)			
			Command	Area type	Sets the area to write command data to the Sensor. Control inputs, command codes, and command parameters are written to this area.	PLC Link (SYSMAC CS/CJ/CP/One) CIO Area (CIO) (Default) Work Area (WR) Holding Bit Area (HR) Auxiliary Bit Area (AR) DM Area (DM) EM Area (EM0 to EMC)	System
					PLC Link (MELSEC QnU/Q/QnAS) Data Register (Default) File Register Link Register		
	Response		Area type	Sets the area to write execution results from the Sensor. Control outputs, command codes, response codes, and response data	PLC Link (SYSMAC CS/CJ/CP/One) CIO Area (CIO) (Default), Work Area (WR), Holding Bit Area (HR), Auxiliary Bit Area (AR), DM Area (DM), EM Area (EM0 to EMC)	System	---*1
				PLC Link (MELSEC QnU/Q/QnAS) Data Register (Default) File Register Link Register			
Address	Address	Set the first address of the command area.	0 to 99,999 (Default: 0)	System			
		Set the first address of the response area.	0 to 99999 (Default: 100)	System			

Menu command			Description	Setting range	Data			
Sensor settings	Data output	Link data output	Area settings	Output Area type	Sets the area to write output data from measurements. Output data 0 to 31	PLC Link (SYSMAC CS/CJ/CP/One) CIO Area (CIO) (Default) Work Area (WR) Holding Bit Area (HR) Auxiliary Bit Area (AR) DM Area (DM) EM Area (EM0) EM Area (EM1) : EM Area (EMC) PLC Link (MELSEC QnU/Q/QnAS) Data Register (Default) File Register Link Register	System	---*1
		Set the first address of the output area .						
		Output hand-shake	Sets whether to establish an interlock with the PLC when data is output.	<ul style="list-style-type: none"> No (Default) Yes 	System	---*1		
		Retry details	Enables or disables retrying communications.	<ul style="list-style-type: none"> ON (Default) OFF 	System	---*1		
		Retry interval	Sets the interval for retrying communications. This setting is enabled only when [Retry details] is set to [ON].	0 to 2,147,483,647 ms (Default:10,000 ms)	System	---*1		
		Max output data	Sets the upper limit of the number of output data to use for PLC Link outputs. Any output data that is beyond this value is discarded.	32 to 1024 (Default: 256)	System	---*1		
		Connection mode	Sets the TCP connection mode.	<ul style="list-style-type: none"> TCP server (Default) TCP client 	System	---*1		
		Data output period	Set the period for outputting measurement results. This parameter is displayed and can be set only when [Handshake setting] is set to [No].	2 to 5,000 ms (Default: 40 ms)	System	---*1		
		GATE signal ON period	Set the time to turn ON the GATE signal. This parameter is displayed and can be set only when [Handshake setting] is set to [No].	1 to 1,000 ms (Default: 20 ms)	System	---*1		
	IP address	Sets the IP address to which to output. * Setting is not possible if the connection mode is set to a TCP server.	a.b.c.d a: 1 to 223 b: 0 to 255 c: 0 to 255 d: 1 to 254 (Default:10.5.5.111)	System	---*1			
	Output port No.	Sets the output port number. * Setting is not possible if the connection mode is set to a TCP server.	0 to 65535 (Default: 9600)	System	---*1			
	Fieldbus data output settings	Communication type	Specifies the type of communication used for Fieldbus data output.	Invalid (Default) EtherNet/IP PROFINET	System	---*1		
		Output hand-shake	Sets whether to establish an interlock with the PLC when data is output. OFF: Outputs data regardless of the state of the signal from the PLC. Handshake: Outputs data after recognition of DSA from the PLC.	No Yes (Default)	System	---*1		
Output data size		Sets the data size to output for EtherNet/IP or PROFIBUS output. If the data size that is set is exceeded, data will be output in more than one transfer.	32 bytes (Default) 64 bytes 128 bytes 256 bytes	System	---*1			
Refreshing task period		Set the communications cycle for cyclic tag data link communications for the Sensor.	1 to 10,000 ms (Default:10 ms)	System	---*1			

Menu command		Description	Setting range	Data			
Sensor settings	Data output Fieldbus data output settings	Timeout	Sets the timeout time when handshaking is enabled.	0.1 to 120.0 s (Default: 10 s)	System	---*1	
		Data output period	Set the period for outputting measurement results. This parameter is displayed and can be set only when [Handshake setting] is set to [No].	2 to 5,000 ms (Default: 40 ms)	System	---*1	
		GATE signal ON period	Set the time to turn ON the GATE signal. This parameter is displayed and can be set only when [Handshake setting] is set to [No].	1 to 1,000 ms (Default: 20 ms)	System	---*1	
	Initialize		Initializes the Sensor settings and saved data.	---	---	p. 428	
	Restart		Restarts the Sensor.	---	---		
	Update		Updates the Sensor system to the most recent data.	---	---	p. 573	
	TF settings	Information		Used to check the Touch Finder information.	---	Touch Finder data	p. 428
Model		Used to check the Touch Finder model.	---	Touch Finder data	p. 428		
Version		Used to check the software version of the Touch Finder.	---				
MAC address		Used to check the MAC address of the Touch Finder.	---	---	---		
		Memory state	Used to check the Touch Finder memory state.	---	---	p. 383	
Error history		View history	Displays a history of errors that have occurred in the Touch Finder.	---	---	p. 435	
		Delete history	Deletes the error history.		---		
Battery level		Used to check the battery level.	---	---	p. 384		
File format Logging data file		Logging image file	File name prefix	You can set a character string to add to the beginning of the file name for logged data.	---	Touch Finder data	p. 397
			File name prefix				
	Output format	Field separator	Used to set the output format for output log data to a file.	None Comma (Default) Tab Space Colon Semicolon CR CR+LF	Touch Finder data	p. 398	
		Decimal symbol		None Point (Default) Comma			
Record separator	None Comma Tab Space Colon Semicolon CR CR+LF (Default)						



Menu command		Description	Setting range	Data				
TF settings	SD card	SD card information	Displays the capacity and remaining memory in the SD card.	---	Touch Finder data	p. 411		
		Format	Formats an SD card.	---		p. 412		
	Startup display	Startup screen type	You can select the display to appear on the Touch Finder when more than one Sensor is connected.	Multi Sensor NG sensor Single sensor Auto (Default)		Touch Finder data	p. 389	
		Specify sensor	You can specify one Sensor to connect to the Touch Finder.	ON OFF (Default)			p. 417	
		Display pattern	Sets the display to use in Run Mode. (Only appears when [Start screen type] under [Startup display] is set to [Single sensor].)	Graphic All results/Region Trend monitor	Graphics + Details Statistical data Histogram			p. 356 p. 416
		Display update mode	Sets the image to update in Run Mode.	Latest image Last NG image			p. 383	
	LCD backlight	Brightness	Sets the brightness.	0 to 5		Touch Finder data	p. 384	
		ECO mode	Enables (ON) or disables (OFF) ECO Mode.	ON OFF			p. 384	
	Ethernet			---		Touch Finder data	p. 67	
		DHCP	Used to automatically connect to the IP address of the Touch Finder.	OFF (Default) ON		Touch Finder data	p. 67	
		IP address	Inputs the IP address of the Touch Finder. (Valid only when the [IP address setting] is set to [Fixed].)	a.b.c.d a: 1 to 223 b: 0 to 255 c: 0 to 255 d: 0 to 255 (Default: 10.5.5.10)		Touch Finder data	p. 67	
		Subnet mask	Inputs the subnet mask. (Valid only when the [IP address setting] is set to [Fixed].)	0.0.0.0 to 255.255.255.255 (Default: 255.255.255.0)		Touch Finder data	p. 67	
		Gateway	Sets the Default gateway address. (When the [IP address setting] is set to [Fixed].)	1.0.0.1 to 223.255.255.254 (Default: 10.5.5.1)		Touch Finder data	p. 67	
	Auto sensor detection		The Touch Finder can detect Sensors and automatically connect to them in the order that it detects them.	ON OFF (Default)		Touch Finder data	p. 386	
	Logging setting		You must enable file logging before you can execute it.	ON (Default) OFF			p. 399	
Language		Changes the language to display on the Touch Finder.	English, German French, Italian, Spanish, Traditional Chinese Simplified Chinese Korean, Japanese (The Default language is selected at startup.)			p. 427		
Time settings		Used to set the current date and time.	Default: Selected at startup.	---		p. 427		
Touch screen calib		Used when there is an offset between the touch screen positions and pointers.	---	---		p. 427		
Initialize		Initializes the Touch Finder settings.	---	---		p. 428		
Restart		Restarts the Touch Finder.	---	---		p. 428		
Update		Updates the Touch Finder system to the most recent data.	---	---		p. 573		
Re-assign IP forcibly		Executed when a sensor on the same network cannot be detected and the sensor's IP address is not known.	---	---		p. 436		

*1 Refer to FQ2-S/CH Series User's Manual for Communications Settings (Cat. No. Z338).

*2 Not supported on the FQ2-S1/S2/S3 Series.











*3 Not supported on the FQ2-CH Series.

Run Mode

Menu command		Description	Setting range	Data		
Select display	Graphic	Displays the input image.		---	p. 354	
	Graphics + Details	Displays the inspection item individual judgement results and measurement values.		---		
	Statistical data	Displays the total number of measurements and the total number of NG overall judgements and the NG ratio from when the power supply was turned ON.	---	---		
	All results/Region	Displays the inspection item individual judgement results for all inspection items.		---		
	Trend Monitor	Displays the individual judgement results saved in the Sensor in a trend monitor.		---		p. 358
	Histogram	Displays the individual judgement results saved in the Sensor in a histogram.		---		p. 360
	 Model region (Search, Shape Search III, Search, Shape Search II, and Sensitive Search only in [Adjustment mode in Run] to [ON])	Changes to Setup Mode to adjust the model region set for each inspection item.	---	---	---	
	Insp. region (Only in [Adjustment mode in Run] to [ON])	Changes to Setup Mode to adjust the inspection region set for each inspection item.		---	---	
	Select display image (Area and Labeling only)	Changes the display method of the extracted color.	<ul style="list-style-type: none"> • For Area and Labeling • Measurement image (Default) • Color extraction image • Binary image after extraction <ul style="list-style-type: none"> • For Area and Labeling • Measurement image (Default) • ImageMeas. Img.+Targ. Mdl. • Edge Image • Edge Image+Targ. Mdl. 	---		
	Adjust judgement (Except for statistical data)	Adjusts judgement parameters without stopping measurements.	---	---	p. 362	
	Auto display (trend monitor and histogram only)	Automatically sets the display range according to the measurement results.	OFF ON (Default)		p. 359 p. 361	
	Display range (trend monitor and histogram only)	Changes the display range of measurement values.	Measurement value: -999,999,999 to 999,999,999 (Defaults: Lower limit: 0 Upper limit: 100) class: 5 to 100 (Default: 10) (Histograms only)		Touch Finder data p. 359 p. 361	
	Number of data (trend monitor only)	Changes the number of displayed measurement values.	200 400 1000 (Default: 200)		p. 359	
	Number of data (histogram only)	Changes the number of displayed measurement values (i.e., the vertical display range of the histogram).	5 to 1,000		p. 361	
Clear results (graphic or graphic + details list)	Clears the measurement results of the inspection items.	---		---		
Delete stats (total data)	Clears the Statistical data.	---		---		

Menu command		Description	Setting range	Data	
Logging	Image logging	Starts and stops logging in external memory.	ON: Start or OFF: Stop		p. 399
	Data logging		ON: Start or OFF: Stop		
TF settings		The same as for Setup Mode. (This does not apply to the PC Tool.) The resolution of the measurement image can be set on the PC Tool.			p. 427
Sensor setting		Switches to Setup Mode.	---	---	p. 353
Sensor monitor	Single sensor	Displays the image of a sensor specified from among multiple connected sensors.	---	Touch Finder data	p. 389
	Multi sensor	Simultaneously displays the images for multiple connected Sensors.	---		
		Display position	Specifies the display position when multiple sensors are connected.		
		Auto position	Resets the display position.	---	
	Setting disp. info.	Specifies the information displayed for the connected sensor.	OFF IP address (Default) Sensor name	Touch Finder data	
NG sensor		From multiple connected Sensors, displays the image of only the Sensors with NG results.	---	Touch Finder data	
Switch sensor	Select	Switches to the selected Sensor.	---	---	Touch Finder data
		Display position	Specifies the display position when multiple sensors are connected.	---	
	Setting disp. info.	Specifies the information displayed to identify the connected sensor.	OFF IP address (Default) Sensor name	Touch Finder data	
Sensor list		Specifies sensors to be connected.	---	---	p. 388
Network		Changes the network settings of a sensor.	---	---	
Switch sensor		Applies the connection settings and changes the displayed sensor.	---	---	
Delete		Deletes a sensor from the sensor list.	---	---	
Comm. test		Tests communication with the sensor.	---	---	
Add		Adds a fixed IP address to the sensor list.	---	---	
Update list		Updates the sensor list to the most recent state.	---	---	

Common Menu Commands

Menu command	Description	Setting range	Data		
 Only-image Button	Hides text and displays only the image.	---	---	p. 384	
 Display Button	 Zoom-in Button	Enlarges the image display.	---	p. 380	
	 Zoom-out Button	Reduces the image display.			
	 FIT Button	Fits the image to the display size.			
	 Live	Switches the camera image between a live image and a frozen image.	(Only in Setup Mode)	--	p. 380
	 Freeze			--	p. 381
	 Display Button	Changes the image display method.	Setup Mode: Camera (Live, Freeze) Log Logging image file Camera image file Run Mode: Latest image or Last NG image	---	p. 380 p. 381 p. 383
	 Log Image Button (Only in Setup Mode)	You can save the Camera image that is displayed on the Touch Finder or computer.	---	---	p. 382
 Capture Button	Used to capture the current display and save it in external memory, e.g., an SD card.	---	---	p. 415	

9-2 External Reference Parameters

FQ2-S1

FQ2-S2

FQ2-S3

FQ2-S4

FQ2-CH

Color Gray Filter (Color type only)

External reference number	Category	Data name	Set/Get	Data range	Default	Expression text string	Logged data/Judgement parameter
0	Measurement result	Judgement	Get only	-2: No judgement (not measured), 0: Judgement is OK, -1: Judgement is NG, -13: Teaching not performed error -14: Figure not registered error -15: Out of range error	-2	JG	---
120	Measurement conditions	Source image	Set / Get	0: Camera image 1: Previous image	1	---	---
121		Setting method	Set / Get	0: Filtering OFF, 1: Filtering ON	1	---	---
122		Filter type	Set / Get	Filter type 0: RGB 1: HSV	0	---	---
123		Color filter type	Set / Get	Color Filter Type 0: Red filter 1: Green filter 2: Blue filter 3: Cyan filter 4: Magenta filter 5: Yellow filter 6: Gray filter (R+G+B) 7: Gray filter (R+2G+B) 8: Gray filter (user-set)	0	---	---
124		Color gray filter type	Set / Get	Color Gray Filter Type 0: High speed, 1: High precision	1	---	---
125		RGB gain R	Set / Get	0.0001 to 9.9999	0.3	---	---
126		RGB gain G	Set / Get	0.0001 to 9.9999	0.59	---	---
127		RGB gain B	Set / Get	0.0001 to 9.9999	0.11	---	---
128		Standard hue	Set / Get	0 to 359	0	---	---
129		Hue range	Set / Get	10 to 180	90	---	---
130		Chroma upper limit	Set / Get	0 to 255	255	---	---
131	Chroma lower limit	Set / Get	0 to 255	0	---	---	

Weak Smoothing

External reference number	Category	Data name	Set / Get	Data range	Default	Expression text string	Logged data/ Judgement parameter
0	Measurement result	Judgement	Get only	-2: No judgement (not measured), 0: Judgement is OK, -1: Judgement is NG, -13: Teaching not performed error, -14: Figure not registered error, -15: Out of range error	-2	JG	---
120	Measurement conditions	Source image	Set / Get	0: Camera image 1: Previous image	1	---	---
121		Setting method	Set / Get	0: Filtering OFF 1: Filtering ON	1	---	---

Strong Smoothing

External reference number	Category	Data name	Set / Get	Data range	Default	Expression text string	Logged data/ Judgement parameter
0	Measurement result	Judgement	Get only	-2: No judgement (not measured), 0: Judgement is OK, -1: Judgement is NG, -13: Teaching not performed error, -14: Figure not registered error, -15: Out of range error	-2	JG	---
120	Measurement conditions	Source image	Set / Get	0: Camera image, 1: Previous image	1	---	---
121		Setting method	Set / Get	0: Filtering OFF, 1: Filtering ON	1	---	---

Dilate

External reference number	Category	Data name	Set / Get	Data range	Default	Expression text string	Logged data/ Judgement parameter
0	Measurement result	Judgement	Get only	-2: No judgement (not measured), 0: Judgement is OK, -1: Judgement is NG, -13: Teaching not performed error, -14: Figure not registered error, -15: Out of range error	-2	JG	---
120	Measurement conditions	Source image	Set / Get	0: Camera image, 1: Previous image	1	---	---
121		Setting method	Set / Get	0: Filtering OFF, 1: Filtering ON	1	---	---

Erosion, Median, Extract Edges, Extract Horizontal Edges, Extract Vertical Edges, Enhance edges

External reference number	Category	Data name	Set / Get	Data range	Default	Expression text string	Logged data/ Judgement parameter
0	Measurement result	Judgement	Get only	-2: No judgement (not measured), 0: Judgement is OK, -1: Judgement is NG, -13: Teaching not performed error, -14: Figure not registered error, -15: Out of range error	-2	JG	---
120	Measurement conditions	Source image	Set / Get	0: Camera image, 1: Previous image	1	---	---
121	Measurement conditions	Setting method	Set / Get	0: Filtering OFF, 1: Filtering ON	1	---	---

Background Suppression

External reference number	Category	Data name	Set / Get	Data range	Default	Expression text string	Logged data/ Judgement parameter
0	Measurement result	Judgement	Get only	-2: No judgement (not measured) 0: Judgement is OK -1: Judgement is NG -13: Teaching not performed error -14: Figure not registered error -15: Out of range error	-2	JG	---
120	Measurement conditions	Source image	Set / Get	0: Camera image 1: Previous image	1	---	---
122	Measurement conditions	Image format	Set / Get	0: Binary image 1: Monochrome image 2: Color image	0	---	---
123	Measurement conditions	Color setting mode	Set / Get	0: RGB common, 1: RGB individual	0	---	---
124	Measurement conditions	Common color lower limit	Set / Get	0 to 255	0	---	---
125	Measurement conditions	Common color upper limit	Set / Get	0 to 255	255	---	---
126	Measurement conditions	R lower limit	Set / Get	0 to 255	0	---	---
127	Measurement conditions	R upper limit	Set / Get	0 to 255	255	---	---
128	Measurement conditions	G lower limit	Set / Get	0 to 255	0	---	---
129	Measurement conditions	G upper limit	Set / Get	0 to 255	255	---	---

External reference number	Category	Data name	Set / Get	Data range	Default	Expression text string	Logged data/ Judgement parameter
130	Measurement conditions	B lower limit	Set / Get	0 to 255	0	---	---
131		B upper limit	Set / Get	0 to 255	255	---	---
132		Grayscale lower limit	Set / Get	0 to 255	0	---	---
133		Grayscale upper limit	Set / Get	0 to 255	255	---	---

Shape Search II (FQ2-S1/S2/S3 series or FQ2-S4 series only)

External reference number	Category	Data name	Set / Get	Data range	Default	Expression text string	Logged data/ Judgement parameter	
0	Measurement result	Judgement	Get only	-2: No judgement (not measured) 0: Judgement is OK -1: Judgement is NG -13: Teaching not performed error -14: Figure not registered error -15: Out of range error	-2	JG	Logged	
5		Correlation	Get only	0 to 100	0	CR[0] to CR[31]	Logged	
6		Position X	Get only	-99,999.9999 to 99,999.9999	0	Y[0] to Y[31]	Logged	
7		Position Y	Get only	-99,999.9999 to 99,999.9999	0	---	Logged	
8		Angle	Get only	-180 to 180	0	---	Logged	
9		Reference X	Get only	-99,999.9999 to 99,999.9999	255	---	---	
10		Reference Y	Get only	-99,999.9999 to 99,999.9999	0	---	---	
11		Reference angle	Get only	-180 to 180	255	---	---	
12		Detection coordinate X	Get only	-99,999.9999 to 99,999.9999	0	---	---	
13		Detection coordinate Y	Get only	-99,999.9999 to 99,999.9999	255	---	---	
14		Count	Get only	0 to 32	0	C	---	
103		Output parameter	Reflect	Set / Get	0: Yes 1: No	0	---	---
120		Model region	Rotation	Set / Get	0: No 1: Yes	0	---	---
121			Rotation angle upper limit	Set / Get	-180 to 180	180	---	---
122	Rotation angle lower limit		Set / Get	-180 to 180	-180	---	---	
133	Measurement conditions	Candidate level	Set / Get	0 to 100	80	---	---	

External reference number	Category	Data name	Set / Get	Data range	Default	Expression text string	Logged data/ Judgement parameter
134	Detection point coordinate	Detection point X	Set / Get	0 to 9999	0	---	---
135		Detection point Y	Set / Get	0 to 9999	0	---	---
136	Measurement condition	Sort condition	Set / Get	0: Ascending order of correlation value, 1: Descending order of correlation value, 2: Ascending order of position X, 3: Descending order of position X, 4: Ascending order of position Y, 5: Descending order of position Y	1	---	---
138	Judgement conditions	Judgement upper limit for correlation	Set / Get	0 to 100	100	---	Judgement condition
139		Judgement lower limit for correlation	Set / Get	0 to 100	0	---	Judgement condition
140		Judgement upper limit for detection count	Set / Get	0 to 32	32	---	Judgement condition
141		Setting/Acquisition	Set / Get	0 to 32	0	---	Judgement condition
142		Judgement upper limit for search coordinate X	Set / Get	-99,999.9999 to 99,999.9999	99,999.9999	---	Judgement condition
143		Judgement lower limit for search coordinate X	Set / Get	-99,999.9999 to 99,999.9999	-99,999.9999	---	Judgement condition
144		Judgement upper limit for search coordinate Y	Set / Get	-99,999.9999 to 99,999.9999	99,999.9999	---	Judgement condition
145		Judgement lower limit for search coordinate Y	Set / Get	-99,999.9999 to 99,999.9999	-99,999.9999	---	Judgement condition
146		Judgement upper limit for search angle	Set / Get	-180 to 180	180	---	Judgement condition
147		Judgement lower limit for search angle	Set / Get	-180 to 180	-180	---	Judgement condition
152	Measurement conditions	Extraction condition, X upper limit	Set / Get	-99,999.9999 to 99,999.9999	99,999.9999	---	Judgement condition
153		Extraction condition, X lower limit	Set / Get	-99,999.9999 to 99,999.9999	-99,999.9999	---	Judgement condition
154		Extraction condition, Y upper limit	Set / Get	-99,999.9999 to 99,999.9999	99,999.9999	---	Judgement condition
155		Extraction condition, Y lower limit	Set / Get	-99,999.9999 to 99,999.9999	-99,999.9999	---	Judgement condition
161		Detection count	Set / Get	1 to 32	32	---	---
170		Number of data log records upper limit	Set / Get	0: Fast 1: Stable	0	---	---
300		Number of data log records upper limit	Set / Get	0: Data logging OFF 1: Data logging ON	1	---	---
310		Data logging switch for entire unit	Set / Get	0: Data logging OFF 1: Data logging ON	1	---	---
311		Data logging switch for judgement	Set / Get	0: Data logging OFF 1: Data logging ON	1	---	---

External reference number	Category	Data name	Set / Get	Data range	Default	Expression text string	Logged data/Judgement parameter
312	Logging conditions	Data logging switch for correlation	Set / Get	0: Data logging OFF 1: Data logging ON	1	---	---
313		Data logging switch for position X	Set / Get	0: Data logging OFF 1: Data logging ON	1	---	---
314		Data logging switch for position Y	Set / Get	0: Data logging OFF 1: Data logging ON	1	---	---
315		Data logging switch for measurement angle	Set / Get	0: Data logging OFF 1: Data logging ON	1	---	---
321		Data logging switch for detection count	Set / Get	0: Data logging OFF 1: Data logging ON	1	---	---
700	Display settings	Correlation display	Set / Get	0: Display 1: Do not display	0	---	---
701		Position X display	Set / Get	0: Display 1: Do not display	0	---	---
702		Position Y display	Set / Get	0: Display 1: Do not display	0	---	---
703		Measurement angle display	Set / Get	0: Display 1: Do not display	0	---	---
704		Count display	Set / Get	0: Display 1: Do not display	0	---	---
800		Position X display pattern	Set / Get	0: Absolute value 1: Relative value	0	---	---
801		Position Y display pattern	Set / Get	0: Absolute value 1: Relative value	0	---	---
802		Measurement angle display pattern	Set / Get	0: Absolute value 1: Relative value	0	---	---

Shape Search III Position Compensation (FQ2-S1/S2/S3 series or FQ2-S4 series only)

External reference number	Category	Data name	Set / Get	Data range	Default	Expression text string	Logged data/ Judgement parameter
0	Measurement result	Judgement	Get only	-2: No judgement (not measured) 0: Judgement is OK -1: Judgement is NG -13: Teaching not performed error -14: Figure not registered error -15: Out of range error	-2	JG	Logged data
5		Scroll X	Get only	-99999.9999 to 99999.9999	0	DX	Logged data
6		Scroll Y	Get only	-99999.9999 to 99999.9999	0	DY	Logged data
7		Scroll θ	Get only	-180 to 180	0	DT	Logged data
8		Position X	Get only	-99999.9999 to 99999.9999	0	X	Logged data
9		Position Y	Get only	-99999.9999 to 99999.9999	0	Y	Logged data
10		Angle	Get only	-180 to 180	0	TH	Logged data
11		Reference X	Get only	0 to 9,999	0	SX	Logged data
12		Reference Y	Get only	0 to 9,999	0	SY	Logged data
13		Reference angle	Get only	-180 to 180	0	ST	Logged data
14		Correlation	Get only	0 to 100	0	CR	Logged data
103	Output parameter	Reflect	Set / Get	0: Yes 1: No	0	---	---
120	Model region	Position compensation precision	Set / Get	0: None 1: Bilinear	0	---	---
122		Position compensation image	Set / Get	0: Camera image 1: Previous image	1	---	---
123	Model region	Rotation	Set / Get	0: No rotation 1: Rotation	1	---	---
124		Rotation	Set / Get	0 to 9,999	0	---	---
125		Reference X	Set / Get	0 to 9,999	0	---	---
126		Reference Y	Set / Get	-180 to 180	0	---	---
140		Reference angle	Set / Get	-180 to 180	180	---	---
141		Rotation angle upper limit	Set / Get	-180 to 180	-180	---	---
149	Measurement condition	Rotation angle lower limit	Set / Get	0 to 100	70	---	---
150	Detection point coordinate	Candidate level	Set / Get	0 to 9,999	0	---	---
151		Detection point X	Set / Get	0 to 9,999	0	---	---
160	Judgement conditions	Judgement upper limit for search coordinate X	Set / Get	-99,999.9999 to 99,999.9999	99,999.9999	---	Judgement condition

External reference number	Category	Data name	Set / Get	Data range	Default	Expression text string	Logged data/ Judgement parameter
161	Judgement conditions	Judgement lower limit for search coordinate X	Set / Get	-99,999.9999 to 99,999.9999	- 99,999.9999	---	Judgement condition
162		Judgement upper limit for search coordinate Y	Set / Get	-99,999.9999 to 99,999.9999	99,999.9999	---	Judgement condition
163		Judgement lower limit for search coordinate Y	Set / Get	-99,999.9999 to 99,999.9999	- 99,999.9999	---	Judgement condition
164		Judgement upper limit for search angle	Set / Get	-180 to 180	180	---	Judgement condition
165		Judgement lower limit for search angle	Set / Get	-180 to 180	-180	---	Judgement condition
166		Judgement upper limit for correlation	Set / Get	0 to 100	100	---	Judgement condition
167		Judgement lower limit for correlation	Set / Get	0 to 100	60	---	Judgement condition
168		Position compensation X upper limit	Set / Get	-99,999.9999 to 99,999.9999	99,999.9999	---	Judgement condition
169		Position compensation X lower limit	Set / Get	-99,999.9999 to 99,999.9999	- 99,999.9999	---	Judgement condition
170		Position compensation Y upper limit	Set / Get	-99,999.9999 to 99,999.9999	99,999.9999	---	Judgement condition
171		Position compensation Y lower limit	Set / Get	-99,999.9999 to 99,999.9999	- 99,999.9999	---	Judgement condition
172		Theta position compensation upper limit	Set / Get	-180 to 180	180	---	Judgement condition
173		Theta position compensation lower limit	Set / Get	-180 to 180	-180	---	Judgement condition
174		Judgement condition	Disp. Image Selection	Set / Get	0: Measurement image 1: Meas. Img.+Model Img. 2: Edge Image 3: Edge Img.+ Model Img.	1	---
178	Edge Level		Set / Get	0: No 1: Yes	1	---	---
179	Mask Size		Set / Get	0: 3×3 1: 5×5 2: 7×7	0	---	---
182	Edge Level Auto		Set / Get	0: OFF 1: ON	1	---	---
184	Acceptable Dist. Level		Set / Get	0: Low 1: Medium 2: High	2	---	---
185	Noise Removal Level		Set / Get	0 to 100	0	---	---

External reference number	Category	Data name	Set / Get	Data range	Default	Expression text string	Logged data/ Judgement parameter
310	Logging conditions	Data logging switch for entire unit	Set / Get	0: Data logging OFF 1: Data logging ON	0	---	---
311		Data logging switch for judgement	Set / Get	0: Data logging OFF 1: Data logging ON	0	---	---
312		Data logging switch for scroll X	Set / Get	0: Data logging OFF 1: Data logging ON	0	---	---
313		Data logging switch for scroll Y	Set / Get	0: Data logging OFF 1: Data logging ON	0	---	---
314		Data logging switch for scroll θ	Set / Get	0: Data logging OFF 1: Data logging ON	0	---	---
315		Position compensation X display	Set / Get	0: Data logging OFF 1: Data logging ON	0	---	---
316		Position compensation Y display	Set / Get	0: Data logging OFF 1: Data logging ON	0	---	---
317		Theta position compensation display	Set / Get	0: Data logging OFF 1: Data logging ON	0	---	---
318		Correlation display	Set / Get	0: Data logging OFF 1: Data logging ON	0	---	---
319		Position X display	Set / Get	0: Data logging OFF 1: Data logging ON	0	---	---
320		Position Y display	Set / Get	0: Data logging OFF 1: Data logging ON	0	---	---
321		Measurement angle display	Set / Get	0: Data logging OFF 1: Data logging ON	0	---	---
700	Display settings	Position compensation X display	Set / Get	0: Display 1: Do not display	0	---	---
701		Position compensation Y display	Set / Get	0: Display 1: Do not display	0	---	---
702		Theta position compensation display	Set / Get	0: Display 1: Do not display	0	---	---
703		Correlation display	Set / Get	0: Display 1: Do not display	0	---	---
704		Position X display	Set / Get	0: Display 1: Do not display	0	---	---
705		Position Y display	Set / Get	0: Display 1: Do not display	0	---	---
706		Measurement angle display	Set / Get	0: Display 1: Do not display	0	---	---

Shape Search Position Compensation

External reference number	Category	Data name	Set / Get	Data range	Default	Expression text string	Logged data/ Judgement parameter	
0	Measurement result	Judgement	Get only	-2: No judgement (not measured) 0: Judgement is OK -1: Judgement is NG -13: Teaching not performed error -14: Figure not registered error -15: Out of range error	-2	JG	Logged data	
5		Scroll X	Get only	-99999.9999 to 99999.9999	0	DX	Logged data	
6		Scroll Y	Get only	-99999.9999 to 99999.9999	0	DY	Logged data	
7		Scroll θ	Get only	-180 to 180	0	DT	Logged data	
8		Position X	Get only	-99999.9999 to 99999.9999	0	X	Logged data	
9		Position Y	Get only	-99999.9999 to 99999.9999	0	Y	Logged data	
10		Angle	Get only	-180 to 180	0	TH	Logged data	
11		Reference X	Get only	0 to 9,999	0	SX	Logged data	
12		Reference Y	Get only	0 to 9,999	0	SY	Logged data	
13		Reference angle	Get only	-180 to 180	0	ST	Logged data	
14		Correlation	Get only	0 to 100	0	CR	Logged data	
103		Output parameter	Reflect	Set / Get	0: Yes 1: No	0	---	---
120		Measurement conditions	Position compensation precision	Set / Get	0: None 1: Bilinear	0	---	---
121			Setting method	Set / Get	0: Cancel position compensation 1: Position compensation based on internal search	1	---	---
122	Position compensation image		Set / Get	0: Camera image, 1: Previous image	1	---	---	
123	Model region	Rotation	Set / Get	0: No rotation 1: Rotation	1	---	---	
124		Reference X	Set / Get	0 to 9,999	0	---	---	
125		Reference Y	Set / Get	0 to 9,999	0	---	---	
126		Reference angle	Set / Get	-180 to 180	0	---	---	
140		Rotation angle upper limit	Set / Get	-180 to 180	180	---	---	
141		Rotation angle lower limit	Set / Get	-180 to 180	-180	---	---	
149	Measurement condition	Candidate level	Set / Get	0 to 100	70	---	---	
150	Detection point coordinate	Detection point X	Set / Get	0 to 9,999	0	---	---	
151		Detection point Y	Set / Get	0 to 9,999	0	---	---	

External reference number	Category	Data name	Set / Get	Data range	Default	Expression text string	Logged data/ Judgement parameter
156	Measurement condition	Model mode	Set / Get	0: Stable 1: High-speed	0	---	---
160	Judgement conditions	Judgement upper limit for search coordinate X	Set / Get	-99,999.9999 to 99,999.9999	99,999.9999	---	Judgement condition
161		Judgement lower limit for search coordinate X	Set / Get	-99,999.9999 to 99,999.9999	-99,999.9999	---	Judgement condition
162		Judgement upper limit for search coordinate Y	Set / Get	-99,999.9999 to 99,999.9999	99,999.9999	---	Judgement condition
163		Judgement lower limit for search coordinate Y	Set / Get	-99,999.9999 to 99,999.9999	-99,999.9999	---	Judgement condition
164		Judgement upper limit for search angle	Set / Get	-180 to 180	180	---	Judgement condition
165		Judgement lower limit for search angle	Set / Get	-180 to 180	-180	---	Judgement condition
166		Judgement upper limit for correlation	Set / Get	0 to 100	100	---	Judgement condition
167	Judgement conditions	Judgement lower limit for correlation	Set / Get	0 to 100	60	---	Judgement condition
168		Position compensation X upper limit	Set / Get	-99,999.9999 to 99,999.9999	99,999.9999	---	Judgement condition
169		Position compensation X lower limit	Set / Get	-99,999.9999 to 99,999.9999	-99,999.9999	---	Judgement condition
170		Position compensation Y upper limit	Set / Get	-99,999.9999 to 99,999.9999	99,999.9999	---	Judgement condition
171		Position compensation Y lower limit	Set / Get	-99,999.9999 to 99,999.9999	-99,999.9999	---	Judgement condition
172		Theta position compensation upper limit	Set / Get	-180 to 180	180	---	Judgement condition
173		Theta position compensation lower limit	Set / Get	-180 to 180	-180	---	Judgement condition
310	Logging conditions	Data logging switch for entire unit	Set / Get	0: Data logging OFF 1: Data logging ON	0	---	---
311		Data logging switch for judgement	Set / Get	0: Data logging OFF 1: Data logging ON	0	---	---
312		Data logging switch for scroll X	Set / Get	0: Data logging OFF 1: Data logging ON	0	---	---
313		Data logging switch for scroll Y	Set / Get	0: Data logging OFF 1: Data logging ON	0	---	---
314		Data logging switch for scroll θ	Set / Get	0: Data logging OFF 1: Data logging ON	0	---	---

External reference number	Category	Data name	Set / Get	Data range	Default	Expression text string	Logged data/Judgement parameter
315	Logging conditions	Data logging switch for position X	Set / Get	0: Data logging OFF 1: Data logging ON	0	---	---
316		Data logging switch for position Y	Set / Get	0: Data logging OFF 1: Data logging ON	0	---	---
317		Data logging switch for measurement angle	Set / Get	0: Data logging OFF 1: Data logging ON	0	---	---
321		Data logging switch for correlation	Set / Get	0: Data logging OFF 1: Data logging ON	0	---	---
700	Display settings	Position compensation X display	Set / Get	0: Display, 1: Do not display	0	---	---
701		Position compensation Y display	Set / Get	0: Display, 1: Do not display	0	---	---
702		Theta position compensation display	Set / Get	0: Display, 1: Do not display	0	---	---
703		Correlation display	Set / Get	0: Display, 1: Do not display	0	---	---
704		Position X display	Set / Get	0: Display, 1: Do not display	0	---	---
705		Position Y display	Set / Get	0: Display, 1: Do not display	0	---	---
706		Measurement angle display	Set / Get	0: Display, 1: Do not display	0	---	---

Search Position Compensation

External reference number	Category	Data name	Set / Get	Data range	Default	Expression text string	Logged data/ Judgement parameter
0	Measurement result	Judgement	Get only	-2: No judgement (not measured), 0: Judgement is OK, -1: Judgement is NG, -13: Teaching not performed error, -14: Figure not registered error, -15: Out of range error	-2	JG	Logged data
5	Measurement result	Scroll X	Get only	-99,999.9999 to 99,999.9999	0	DX	Logged data
6		Scroll Y	Get only	-99,999.9999 to 99,999.9999	0	DY	Logged data
8		Position X	Get only	-99,999.9999 to 99,999.9999	0	X	Logged data
9		Position Y	Get only	-99,999.9999 to 99,999.9999	0	Y	Logged data
11		Reference X	Get only	-99,999.9999 to 99,999.9999	0	SX	Logged data
12		Reference Y	Get only	-99,999.9999 to 99,999.9999	0	SY	Logged data
14		Correlation	Get only	0 to 100	0	CR	Logged data
103	Output parameter	Reflect	Set / Get	0: Yes 1: No	0	---	---
120	Measurement conditions	Position compensation precision	Set / Get	0: None 1: Bilinear	0	---	---
122	Measurement conditions	Position compensation image	Set / Get	0: Camera image, 1: Previous image	1	---	---
124	Model region	Reference X	Set / Get	0 to 99,999.9999	0	---	---
125		Reference Y	Set / Get	0 to 99,999.9999	0	---	---
145	Detection coordinate	Detection point X	Set / Get	0 to 9,999	0	---	---
146		Detection point Y	Set / Get	0 to 9,999	0	---	---
147	Measurement conditions	Sub-pixel	Set / Get	0: No, 1: Yes	0	---	---
148		Candidate level	Set / Get	0 to 100	70	---	---
166	Judgement conditions	Judgement upper limit for correlation	Set / Get	0 to 100	100	---	Judgement condition
167		Judgement lower limit for correlation	Set / Get	0 to 100	60		

External reference number	Category	Data name	Set / Get	Data range	Default	Expression text string	Logged data/Judgement parameter
310	Logging conditions	Data logging switch for entire unit	Set / Get	0: Data logging OFF 1: Data logging ON	0	---	---
311		Data logging switch for judgement	Set / Get	0: Data logging OFF 1: Data logging ON	0	---	---
312		Data logging switch for scroll X	Set / Get	0: Data logging OFF 1: Data logging ON	0	---	---
313		Data logging switch for scroll Y	Set / Get	0: Data logging OFF 1: Data logging ON	0	---	---
315		Data logging switch for position X	Set / Get	0: Data logging OFF 1: Data logging ON	0	---	---
316		Data logging switch for position Y	Set / Get	0: Data logging OFF 1: Data logging ON	0	---	---
321		Data logging switch for correlation	Set / Get	0: Data logging OFF 1: Data logging ON	0	---	---
700		Display settings	Position compensation X display	Set / Get	0: Display 1: Do not display	0	---
701	Position compensation Y display		Set / Get	0: Display 1: Do not display	0	---	---
702	Correlation display		Set / Get	0: Display 1: Do not display	0	---	---
703	Position X display		Set / Get	0: Display, 1: Do not display	0	---	---
704	Position Y display		Set / Get	0: Display 1: Do not display	0	---	---

Edge Position Compensation

External reference number	Category	Data name	Get / Set	Data range	Default	Expression text string	Logged data/Judgement parameter
0	Measurement result	Judgement	Get only	-2: No judgement (not measured) 0: Judgement is OK -1: Judgement is NG -13: Teaching not performed error -14: Figure not registered error -15: Out of range error	-2	JG	Logged data
5		Scroll X	Get only	-99,999.9999 to 99,999.9999	0	DX	Logged data
6		Scroll Y	Get only	-99,999.9999 to 99,999.9999	0	DY	Logged data
7		Edge position X	Get only	-99,999.9999 to 99,999.9999	0	X	Logged data
8		Edge position Y	Get only	-99,999.9999 to 99,999.9999	0	Y	Logged data
9		Standard position X	Get only	-99,999.9999 to 99,999.9999	0	SX	Logged data
10		Standard position Y	Get only	-99,999.9999 to 99,999.9999	0	SY	Logged data
103		Output parameter	Reflect	Set / Get	0: Yes, 1: No	0	---

External reference number	Category	Data name	Get / Set	Data range	Default	Expression text string	Logged data/ Judgement parameter
120	Measurement conditions	Position compensation precision	Set / Get	0: None, 1: Bilinear	0	---	---
122		Position compensation image	Set / Get	0: Camera image 1: Previous image	1	---	---
140		Set color	Set / Get	0: No edge color specification, 1: Edge color specification	0	---	---
141		Edge color red	Set / Get	0 to 255	255	---	---
142		Edge color green	Set / Get	0 to 255	255	---	---
143		Edge color blue	Set / Get	0 to 255	255	---	---
147	Measurement conditions	Detection mode	Set / Get	0: Color IN 1: Color OUT	0	---	---
149		Edge level	Set / Get	0 to 100	50	---	---
150		Noise level	Set / Get	0 to 442	5	---	---
153		Monochrome density change	Set / Get	(Monochrome Cameras) 0: Light to Dark 1: Dark to Light	0	---	---
154		Edge level absolute value	Set / Get	0 to 442	20	---	---
155		Edge level specification method	Set / Get	0:%, 1: Absolute value	0	---	---
157		Measurement method	Set / Get	(Monochrome Cameras) 0: Projection 1: Differentiation	0	---	---
158		Edge level absolute value (Monochrome Cameras)	Set / Get	0 to 255	20	---	---
180	Judgement conditions	Edge position X upper limit	Set / Get	-99,999.9999 to 99,999.9999	99,999.9999	---	Judgement condition
181		Edge position X lower limit	Set / Get	-99,999.9999 to 99,999.9999	-99,999.9999	---	Judgement condition
182		Edge position Y upper limit	Set / Get	-99,999.9999 to 99,999.9999	99,999.9999	---	Judgement condition
183		Edge position Y lower limit	Set / Get	-99,999.9999 to 99,999.9999	-99,999.9999	---	Judgement condition
184		Position compensation X upper limit	Set / Get	-99,999.9999 to 99,999.9999	99,999.9999	---	Judgement condition
185		Position compensation X lower limit	Set / Get	-99,999.9999 to 99,999.9999	-99,999.9999	---	Judgement condition
186		Position compensation Y upper limit	Set / Get	-99,999.9999 to 99,999.9999	99,999.9999	---	Judgement condition
187	Position compensation Y lower limit	Set / Get	-99,999.9999 to 99,999.9999	-99,999.9999	---	Judgement condition	

External reference number	Category	Data name	Get / Set	Data range	Default	Expression text string	Logged data/ Judgement parameter
310	Logging conditions	Data logging switch for entire unit	Set / Get	0: Data logging OFF 1: Data logging ON	0	---	---
311		Data logging switch for judgement	Set / Get	0: Data logging OFF 1: Data logging ON	0	---	---
312		Data logging switch for scroll X	Set / Get	0: Data logging OFF 1: Data logging ON	0	---	---
313		Data logging switch for scroll Y	Set / Get	0: Data logging OFF 1: Data logging ON	0	---	---
314		Data logging switch for detected edge position X	Set / Get	0: Data logging OFF 1: Data logging ON	0	---	---
315		Data logging switch for detected edge position Y	Set / Get	0: Data logging OFF 1: Data logging ON	0	---	---
700	Display settings	Position compensation X display	Set / Get	0: ON 1: OFF	0	---	---
701		Position compensation Y display	Set / Get	0: ON 1: OFF	0	---	---
702		Detected edge position X display	Set / Get	0: ON 1: OFF	0	---	---
703		Detected edge position Y display	Set / Get	0: ON 1: OFF	0	---	---

Two-edge Position Compensation

External reference number	Category	Data name	Set / Get	Data range	Default	Expression text string	Logged data/ Judgement parameter
0	Measurement result	Judgement	Get only	-2: No judgement (not measured) 0: Judgement is OK, -1: Judgement is NG, -13: Teaching not performed error -14: Figure not registered error -15: Out of range error	-2	JG	Logged data
5		Scroll X	Get only	-99,999.9999 to 99,999.9999	0	DX	Logged data
6		Scroll Y	Get only	-99,999.9999 to 99,999.9999	0	DY	Logged data
7		Detected edge position X0	Get only	-99,999.9999 to 99,999.9999	0	X0	Logged data
8		Detected edge position Y0	Get only	-99,999.9999 to 99,999.9999	0	Y0	Logged data
9		Detected edge position X1	Get only	-99,999.9999 to 99,999.9999	0	X1	Logged data
10		Detected edge position Y1	Get only	-99,999.9999 to 99,999.9999	0	Y1	Logged data
11		Standard position X0	Get only	-99,999.9999 to 99,999.9999	0	SX0	Logged data
12		Standard position Y0	Get only	-99,999.9999 to 99,999.9999	0	SY0	Logged data
13		Standard position X1	Get only	-99,999.9999 to 99,999.9999	0	SX1	Logged data
14		Standard position Y1	Get only	-99,999.9999 to 99,999.9999	0	SY1	Logged data

External reference number	Category	Data name	Set / Get	Data range	Default	Expression text string	Logged data/ Judgement parameter
103	Output parameter	Reflect	Set / Get	0: Yes 1: No	0	---	---
120	Measurement conditions	Position compensation precision	Set / Get	0: None 1: Bilinear	0	---	---
122		Position compensation image	Set / Get	0: Camera image 1: Previous image	0	---	---
140		Edge color specification 0	Set / Get	0: No edge color specification, 1: Edge color specification	0	---	---
141		Edge color R0	Set / Get	0 to 255	255	---	---
142		Edge color G0	Set / Get	0 to 255	255	---	---
143		Edge color B0	Set / Get	0 to 255	255	---	---
147		Density change 0	Set / Get	0: Color IN 1: Color OUT	0	---	---
149		Edge level 0	Set / Get	0 to 100	50	---	---
150		Noise level 0	Set / Get	0 to 442	5	---	---
153		Monochrome density change 0	Set / Get	(Monochrome Cameras) 0: Light to Dark 1: Dark to Light	0	---	---
154		Edge level absolute value	Set / Get	0 to 442	20	---	---
155		Edge level specification method	Set / Get	0:% 1: Absolute value	0	---	---
157		Measurement method 0	Set / Get	(Monochrome Cameras) 0: Projection 1: Differentiation	0	---	---
158		Measurement conditions	Edge level absolute value (Monochrome Cameras)	Set / Get	0 to 255	20	---
160	Edge color specification 1		Set / Get	0: No edge color specification, 1: Edge color specification	0	---	---
161	Edge color R1		Set / Get	0 to 255	255	---	---
162	Edge color G1		Set / Get	0 to 255	255	---	---
163	Edge color B1		Set / Get	0 to 255	255	---	---
167	Density change 1		Set / Get	0: Color IN 1: Color OUT	0	---	---
169	Edge level 1		Set / Get	0 to 100	50	---	---
170	Noise level 1		Set / Get	0 to 442	5	---	---
173	Monochrome density change 1		Set / Get	(Monochrome Cameras) 0: Light to Dark 1: Dark to Light	0	---	---
177	Measurement method 1		Set / Get	(Monochrome Cameras) 0: Projection 1: Differentiation	0	---	---
180	Judgement conditions	Edge position X upper limit 0	Set / Get	-99,999.9999 to 99,999.9999	99,999.9999	---	Judgement condition
181		Edge position X lower limit 0	Set / Get	-99,999.9999 to 99,999.9999	-99,999.9999	---	Judgement condition
182		Edge position Y upper limit 0	Set / Get	-99,999.9999 to 99,999.9999	99,999.9999	---	Judgement condition

External reference number	Category	Data name	Set / Get	Data range	Default	Expression text string	Logged data/Judgement parameter
183	Judgement conditions	Edge position Y lower limit 0	Set / Get	-99,999.9999 to 99,999.9999	-99,999.9999	---	Judgement condition
185		Edge position X upper limit 1	Set / Get	-99,999.9999 to 99,999.9999	99,999.9999	---	Judgement condition
186		Edge position X lower limit 1	Set / Get	-99,999.9999 to 99,999.9999	-99,999.9999	---	Judgement condition
187		Edge position Y upper limit 1	Set / Get	-99,999.9999 to 99,999.9999	99,999.9999	---	Judgement condition
188		Edge position Y lower limit 1	Set / Get	-99,999.9999 to 99,999.9999	-99,999.9999	---	Judgement condition
190		Position compensation X upper limit	Set / Get	-99,999.9999 to 99,999.9999	99,999.9999	---	Judgement condition
191		Position compensation X lower limit	Set / Get	-99,999.9999 to 99,999.9999	-99,999.9999	---	Judgement condition
192		Position compensation Y upper limit	Set / Get	-99,999.9999 to 99,999.9999	99,999.9999	---	Judgement condition
193		Position compensation Y lower limit	Set / Get	-99,999.9999 to 99,999.9999	-99,999.9999	---	Judgement condition
310	Logging conditions	Data logging switch for entire unit	Set / Get	0: Data logging OFF 1: Data logging ON	0	---	---
311		Data logging switch for judgement	Set / Get	0: Data logging OFF 1: Data logging ON	0	---	---
312		Data logging switch for scroll X	Set / Get	0: Data logging OFF 1: Data logging ON	0	---	---
313		Data logging switch for scroll Y	Set / Get	0: Data logging OFF 1: Data logging ON	0	---	---
314		Data logging switch for detected edge position X0	Set / Get	0: Data logging OFF 1: Data logging ON	0	---	---
315	Logging conditions	Data logging switch for detected edge position Y0	Set / Get	0: Data logging OFF 1: Data logging ON	0	---	---
316		Data logging switch for detected edge position X1	Set / Get	0: Data logging OFF 1: Data logging ON	0	---	---
317		Data logging switch for detected edge position Y1	Set / Get	0: Data logging OFF, 1: Data logging ON	0	---	---
700	Display settings	Position compensation X display	Set / Get	0: ON 1: OFF	0	---	---
701		Position compensation Y display	Set / Get	0: ON 1: OFF	0	---	---
702		Detected edge position X0 display	Set / Get	0: ON 1: OFF	0	---	---
703		Detected edge position Y0 display	Set / Get	0: ON 1: OFF	0	---	---
704	Display settings	Detected edge position X1 display	Set / Get	0: ON 1: OFF	0	---	---
705		Detected edge position Y1 display	Set / Get	0: ON 1: OFF	0	---	---

Two-edge Midpoint Compensation

External reference number	Category	Data name	Set / Get	Data range	Default	Expression text string	Logged data/Judgement parameter	
0	Measurement result	Judgement	Get only	-2: No judgement (not measured), 0: Judgement is OK, -1: Judgement is NG, -13: Teaching not performed error, -14: Figure not registered error, -15: Out of range error	-2	JG	Logged data	
5		Scroll X	Get only	-99,999.9999 to 99,999.9999	0	DX	Logged data	
6		Scroll Y	Get only	-99,999.9999 to 99,999.9999	0	DY	Logged data	
7		Detected edge position X0	Get only	-99,999.9999 to 99,999.9999	0	X0	Logged data	
8		Detected edge position Y0	Get only	-99,999.9999 to 99,999.9999	0	Y0	Logged data	
9		Detected edge position X1	Get only	-99,999.9999 to 99,999.9999	0	X1	Logged data	
10		Detected edge position Y1	Get only	-99,999.9999 to 99,999.9999	0	Y1	Logged data	
11		Detected edge midpoint position X	Get only	-99,999.9999 to 99,999.9999	0	MX	Logged data	
12		Detected edge midpoint position Y	Get only	-99,999.9999 to 99,999.9999	0	MY	Logged data	
13		Standard position X0	Get only	-99,999.9999 to 99,999.9999	0	SX0	Logged data	
14		Standard position Y0	Get only	-99,999.9999 to 99,999.9999	0	SY0	Logged data	
15		Standard position X1	Get only	-99,999.9999 to 99,999.9999	0	SX1	Logged data	
16		Standard position Y1	Get only	-99,999.9999 to 99,999.9999	0	SY1	Logged data	
17		Standard midpoint position X	Get only	-99,999.9999 to 99,999.9999	0	SMX	Logged data	
18		Standard midpoint position Y	Get only	-99,999.9999 to 99,999.9999	0	SMY	Logged data	
103		Output parameter	Reflect	Set / Get	0: Yes 1: No	0	---	---
120		Measurement conditions	Position compensation precision	Set / Get	0: None 1: Bilinear	0	---	---
122			Position compensation image	Set / Get	0: Camera image 1: Previous image	0	---	---
140	Edge color specification 0		Set / Get	0: No edge color specification, 1: Edge color specification	0	---	---	
141	Edge color R0		Set / Get	0 to 255	255	---	---	
142	Edge color G0		Set / Get	0 to 255	255	---	---	

External reference number	Category	Data name	Set / Get	Data range	Default	Expression text string	Logged data/Judgement parameter
143	Measurement conditions	Edge color B0	Set / Get	0 to 255	255	---	---
147		Density change 0	Set / Get	0: Color IN, 1: Color OUT	0	---	---
149		Edge level 0	Set / Get	0 to 100(Monochrome Cameras)	50	---	---
150		Noise level 0	Set / Get	0 to 442	5	---	---
153		Monochrome density change 0	Set / Get	(Monochrome Cameras) 0: Light to Dark 1: Dark to Light	0	---	---
154		Edge level absolute value	Set / Get	0 to 442	20	---	---
155		Edge level specification method	Set / Get	0:% 1: Absolute value	0	---	---
157		Measurement method 0	Set / Get	(Monochrome Cameras) 0: Projection 1: Differentiation	0	---	---
158		Edge level absolute value (Monochrome Cameras)	Set / Get	0 to 255	20	---	---
160		Edge color specification 1	Set / Get	0: No edge color specification, 1: Edge color specification	0	---	---
161		Edge color R1	Set / Get	0 to 255	255	---	---
162		Edge color G1	Set / Get	0 to 255	255	---	---
163		Edge color B1	Set / Get	0 to 255	255	---	---
167		Density change 1	Set / Get	0: Color IN 1: Color OUT	0	---	---
169		Edge level 1	Set / Get	0 to 100	50	---	---
170		Noise level 1	Set / Get	0 to 442	5	---	---
173		Monochrome density change 1	Set / Get	(Monochrome Cameras) 0: Light to Dark 1: Dark to Light	0	---	---
177	Measurement method 1	Set / Get	(Monochrome Cameras) 0: Projection 1: Differentiation	0	---	---	
180	Judgement conditions	Edge position X upper limit 0	Set / Get	-99,999.9999 to 99,999.9999	99,999.9999	---	Judgement condition
181		Edge position X lower limit 0	Set / Get	-99,999.9999 to 99,999.9999	-99,999.9999	---	Judgement condition
182		Edge position Y upper limit 0	Set / Get	-99,999.9999 to 99,999.9999	99,999.9999	---	Judgement condition
183		Edge position Y lower limit 0	Set / Get	-99,999.9999 to 99,999.9999	-99,999.9999	---	Judgement condition
185		Edge position X upper limit 1	Set / Get	-99,999.9999 to 99,999.9999	99,999.9999	---	Judgement condition
186		Edge position X lower limit 1	Set / Get	-99,999.9999 to 99,999.9999	-99,999.9999	---	Judgement condition

External reference number	Category	Data name	Set / Get	Data range	Default	Expression text string	Logged data/Judgement parameter
187	Judgement conditions	Edge position Y upper limit 1	Set / Get	-99,999.9999 to 99,999.9999	99,999.9999	---	Judgement condition
188		Edge position Y lower limit 1	Set / Get	-99,999.9999 to 99,999.9999	-99,999.9999	---	Judgement condition
190		Edge midpoint position X upper limit	Set / Get	-99,999.9999 to 99,999.9999	99,999.9999	---	Judgement condition
191		Edge midpoint position X lower limit	Set / Get	-99,999.9999 to 99,999.9999	-99,999.9999	---	Judgement condition
192		Edge midpoint position Y upper limit	Set / Get	-99,999.9999 to 99,999.9999	99,999.9999	---	Judgement condition
193		Edge midpoint position Y lower limit	Set / Get	-99,999.9999 to 99,999.9999	-99,999.9999	---	Judgement condition
194		Position compensation X upper limit	Set / Get	-99,999.9999 to 99,999.9999	99,999.9999	---	Judgement condition
195		Position compensation X lower limit	Set / Get	-99,999.9999 to 99,999.9999	-99,999.9999	---	Judgement condition
196		Position compensation Y upper limit	Set / Get	-99,999.9999 to 99,999.9999	99,999.9999	---	Judgement condition
197		Position compensation Y lower limit	Set / Get	-99,999.9999 to 99,999.9999	-99,999.9999	---	Judgement condition
310	Logging conditions	Data logging switch for entire unit	Set / Get	0: Data logging OFF, 1: Data logging ON	0	---	---
311		Data logging switch for judgement	Set / Get	0: Data logging OFF, 1: Data logging ON	0	---	---
312		Data logging switch for scroll X	Set / Get	0: Data logging OFF, 1: Data logging ON	0	---	---
313		Data logging switch for scroll Y	Set / Get	0: Data logging OFF, 1: Data logging ON	0	---	---
314		Data logging switch for detected edge position X0	Set / Get	0: Data logging OFF, 1: Data logging ON	0	---	---
315		Data logging switch for detected edge position Y0	Set / Get	0: Data logging OFF, 1: Data logging ON	0	---	---
316		Data logging switch for detected edge position X1	Set / Get	0: Data logging OFF, 1: Data logging ON	0	---	---
317		Data logging switch for detected edge position Y1	Set / Get	0: Data logging OFF, 1: Data logging ON	0	---	---
318	Logging conditions	Data logging switch for detected edge midpoint position X	Set / Get	0: Data logging OFF, 1: Data logging ON	0	---	---
319		Data logging switch for detected edge midpoint position Y	Set / Get	0: Data logging OFF, 1: Data logging ON	0	---	---

External reference number	Category	Data name	Set / Get	Data range	Default	Expression text string	Logged data/Judgement parameter
700	Display settings	Position compensation X display	Set / Get	0: ON, 1: OFF	0	---	---
701		Position compensation Y display	Set / Get	0: ON, 1: OFF	0	---	---
702		Detected edge mid-point position X display	Set / Get	0: ON, 1: OFF	0	---	---
703		Detected edge mid-point position Y display	Set / Get	0: ON, 1: OFF	0	---	---
704		Detected edge position X0 display	Set / Get	0: ON, 1: OFF	0	---	---
705		Detected edge position Y0 display	Set / Get	0: ON, 1: OFF	0	---	---
706		Detected edge position X1 display	Set / Get	0: ON, 1: OFF	0	---	---
707		Detected edge position Y1 display	Set / Get	0: ON, 1: OFF	0	---	---

Edge Rotation Position Compensation

External reference number	Category	Data name	Set / Get	Data range	Default	Expression text string	Logged data/Judgement parameter
0	Measurement result	Judgement	Get only	-2: No judgement (not measured) 0: Judgement is OK -1: Judgement is NG -13: Teaching not performed error -14: Figure not registered error -15: Out of range error	-2	JG	Logged data
5		Position compensation TH	Get only	-99,999.9999 to 99,999.9999	0	DT	Logged data
6		Detected edge position X0	Get only	-99,999.9999 to 99,999.9999	0	X0	Logged data
7		Detected edge position Y0	Get only	-99,999.9999 to 99,999.9999	0	Y0	Logged data
8		Detected edge position X1	Get only	-99,999.9999 to 99,999.9999	0	X1	Logged data
9		Detected edge position Y1	Get only	-99,999.9999 to 99,999.9999	0	Y1	Logged data
10		Detected edge angle	Get only	-180 to 180	0	TH	Logged data
11		Standard position X0	Get only	-99,999.9999 to 99,999.9999	0	SX0	Logged data
12		Standard position Y0	Get only	-99,999.9999 to 99,999.9999	0	SY0	Logged data
13		Standard position X1	Get only	-99,999.9999 to 99,999.9999	0	SX1	Logged data
14		Standard position Y1	Get only	-99,999.9999 to 99,999.9999	0	SY1	Logged data
15		Standard edge angle	Get only	-180 to 180	0	STH	Logged data
103		Output parameter	Reflect	Set / Get	0: Yes, 1: No	0	---

External reference number	Category	Data name	Set / Get	Data range	Default	Expression text string	Logged data/ Judgement parameter
120	Measurement conditions	Position compensation precision	Set / Get	0: None, 1: Bilinear	0	---	---
122		Position compensation image	Set / Get	0: Camera image, 1: Previous image	1	---	---
140		Edge color specification 0	Set / Get	0: No edge color specification, 1: Edge color specification	0	---	---
141		Edge color R0	Set / Get	0 to 255	255	---	---
142		Edge color G0	Set / Get	0 to 255	255	---	---
143		Edge color B0	Set / Get	0 to 255	255	---	---
147		Density change 0	Set / Get	0: Color IN, 1: Color OUT	0	---	---
149		Edge level 0	Set / Get	0 to 100	50	---	---
150		Noise level 0	Set / Get	0 to 442	5	---	---
153		Monochrome density change 0	Set / Get	(Monochrome Cameras) 0: Light to Dark, 1: Dark to Light	0	---	---
154		Edge level absolute value	Set / Get	0 to 442	20	---	---
155		Edge level specification method	Set / Get	0:% 1: Absolute value	0	---	---
157		Measurement method 0	Set / Get	(Monochrome Cameras) 0: Projection 1: Differentiation	0	---	---
158		Edge level absolute value (Monochrome Cameras)	Set / Get	0 to 255	20	---	---
160		Edge color specification 0	Set / Get	0: No edge color specification, 1: Edge color specification	0	---	---
161		Edge color R1	Set / Get	0 to 255	255	---	---
162		Edge color G1	Set / Get	0 to 255	255	---	---
163		Edge color B1	Set / Get	0 to 255	255	---	---
167		Density change 1	Set / Get	0: Color IN, 1: Color OUT	0	---	---
169		Edge level 1	Set / Get	0 to 100	50	---	---
170	Noise level 1	Set / Get	0 to 442	5	---	---	
173	Monochrome density change 1	Set / Get	(Monochrome Cameras) 0: Light to Dark 1: Dark to Light	0	---	---	
177	Measurement method 1	Set / Get	(Monochrome Cameras) 0: Projection 1: Differentiation	0	---	---	
180	Judgement conditions	Edge position X upper limit 0	Set / Get	-99,999.9999 to 99,999.9999	99,999.99 99	---	Judgement condition
181		Edge position X lower limit 0	Set / Get	-99,999.9999 to 99,999.9999	- 99,999.99 99	---	Judgement condition
182		Edge position Y upper limit 0	Set / Get	-99,999.9999 to 99,999.9999	99,999.99 99	---	Judgement condition
183		Edge position Y lower limit 0	Set / Get	-99,999.9999 to 99,999.9999	- 99,999.99 99	---	Judgement condition
185		Edge position X upper limit 1	Set / Get	-99,999.9999 to 99,999.9999	99,999.99 99	---	Judgement condition
186		Edge position X lower limit 1	Set / Get	-99,999.9999 to 99,999.9999	- 99,999.99 99	---	Judgement condition

External reference number	Category	Data name	Set / Get	Data range	Default	Expression text string	Logged data/Judgement parameter
187	Judgement conditions	Edge position Y upper limit 1	Set / Get	-99,999.9999 to 99,999.9999	99,999.99 99	---	Judgement condition
188		Edge position Y lower limit 1	Set / Get	-99,999.9999 to 99,999.9999	- 99,999.99 99	---	Judgement condition
190		Edge angle upper limit	Set / Get	-180 to 180	180	---	Judgement condition
191		Edge angle lower limit	Set / Get	-180 to 180	-180	---	Judgement condition
310	Logging conditions	Data logging switch for entire unit	Set / Get	0: Data logging OFF 1: Data logging ON	0	---	---
311		Data logging switch for judgement	Set / Get	0: Data logging OFF 1: Data logging ON	0	---	---
312		Data logging switch for position compensation TH	Set / Get	0: Data logging OFF 1: Data logging ON	0	---	---
313		Data logging switch for detected edge position X0	Set / Get	0: Data logging OFF 1: Data logging ON	0	---	---
314		Data logging switch for detected edge position Y0	Set / Get	0: Data logging OFF 1: Data logging ON	0	---	---
315		Data logging switch for detected edge position X1	Set / Get	0: Data logging OFF 1: Data logging ON	0	---	---
316	Logging conditions	Data logging switch for detected edge position Y1	Set / Get	0: Data logging OFF 1: Data logging ON	0	---	---
317		Data logging switch for detected edge angle	Set / Get	0: Data logging OFF 1: Data logging ON	0	---	---
700	Display settings	Position compensation theta display	Set / Get	0: ON 1: OFF	0	---	---
701		Detected edge angle display	Set / Get	0: ON 1: OFF	0	---	---
702	Display settings	Detected edge position X0 display	Set / Get	0: ON 1: OFF	0	---	---
703		Detected edge position Y0 display	Set / Get	0: ON 1: OFF	0	---	---
704		Detected edge position X1 display	Set / Get	0: ON 1: OFF	0	---	---
705		Detected edge position Y1 display	Set / Get	0: ON 1: OFF	0	---	---

Position Compensation (Image Rotation, Parameter)

External reference number	Category	Data name	Set / Get	Data range	Default	Expression text string	Logged data/ Judgement parameter
0	Measurement result	Judgement	Get only	-2: No judgement (not measured) 0: Judgement is OK -1: Judgement is NG	-2	JG	---
5		Scroll X	Get only	-99999.9999 to 99999.9999	0	DX	---
6		Scroll Y	Get only	-99999.9999 to 99999.9999	0	DY	---
7		Scroll θ	Get only	-180.0000 to 180.0000	0	DT	---
8		Position X	Get only	-99999.9999 to 99999.9999	0	X	---
9		Position Y	Get only	-99999.9999 to 99999.9999	0	Y	---
10		Angle	Get only	-180.0000 to 180.0000	0	TH	---
11		Reference X	Get only	-99999.9999 to 99999.9999	0	SX	---
12		Reference Y	Get only	-99999.9999 to 99999.9999	0	SY	---
13		Reference angle	Get only	-180.0000 to 180.0000	0	ST	---
200	Measurement conditions	Ref. position X (reference position X)	Set / Get	-99999.9999 to 99999.9999	*1	---	---
201		Ref. position Y (reference position Y)	Set / Get	-99999.9999 to 99999.9999	*1	---	---
202		Ref. position θ (reference position θ)	Set / Get	-180.0000 to 180.0000	90	---	---
203		Measurement position X	Set / Get	-99999.9999 to 99999.9999	*1	---	---
204		Measurement position Y	Set / Get	-99999.9999 to 99999.9999	*1	---	---
205		Measurement position θ	Set / Get	-180.0000 to 180.0000	0	---	---

*1: Depends on the model. Refer to Compensating for Position Offset (Position Compensation Items): p. 102.

Linear Correction

External reference number	Category	Data name	Set / Get	Data range	Default	Expression text string	Logged data/Judgement parameter
0	Measurement result	Judgement	Get only	-2: No judgement (not measured) 0: Judgement is OK -1: Judgement is NG	-2	JG	---
120	Measurement conditions	Position interpolation	Set / Get	0: None, 1: Bilinear	1	---	---
122		Source image	Set / Get	0: Camera image, 1: Previous image	1	---	---

OCR (FQ2-S4 or FQ2-CH series only)

External reference number	Category	Data name	Set / Get	Data range	Default	Expression text string	Logged data/Judgement parameter
0	Measurement result	Judgement	Get only	-2: No judgement (not measured) 0: Judgement is OK -1: Judgement is NG -11: Model mismatch error -13: Teaching not performed error -16: Measurement timeout error -17: Format not entered error	-2	JG	Logged data
5		Index number	Get only	-2: No verification pattern or read was NG, -1: Verification result is NG 0 to 31: Master data number	0	IN	Logged data
6		Number of characters	Get only	0 to 128	0	N	Logged data
7		Read character string	Get only	128 characters max.		--	---
8		Similarity	Get only	0 to 100	0	SIM	Logged data
9		Stability	Get only	0 to 100	0	STB	Logged data
103	Output parameter	Reflect	Set / Get	0: Yes 1: No	0	---	---
110		Reading speed	Set / Get	0: Normal 1: Fast	0	---	---
120	Measurement conditions	Character color	Set / Get	0: Black 1: White	0	---	---
121		Dot horizontal interval	Set / Get	0 to 30	0	---	---
122		Dot vertical interval	Set / Get	0 to 30	0	---	---
123		Character thickness threshold	Set / Get	-128 to 128	0	---	---
124		Boundary correction	Set / Get	0: OFF 1: ON	1	---	---
126		Slender character threshold	Set / Get	1 to 10	3	---	---
127		Hyphen height upper threshold	Set / Get	0 to 100	30	---	---

External reference number	Category	Data name	Set / Get	Data range	Default	Expression text string	Logged data/ Judgement parameter
128	Measurement conditions	Hyphen height lower threshold	Set / Get	0 to 100	70	---	---
129		Printing type	Set / Get	0: Solid character 1: Dot character	1	---	---
130		Rotation compensation	Set / Get	0: OFF 1: ON	0	---	---
131		Slant compensation	Set / Get	0: OFF 1: ON	1	---	---
132	Judgement conditions	Similarity judgement upper limit	Set / Get	0 to 100	100	---	Judgement condition
133		Similarity judgement lower limit	Set / Get	0 to 100	60	---	Judgement condition
134		Stability judgement upper limit	Set / Get	0 to 100	100	---	Judgement condition
135		Stability judgement lower limit	Set / Get	0 to 100	10	---	Judgement condition
136	Output parameter	Line delimiter	Set / Get	0: None 1: Comma 2: Space	0	---	---
138		String output ON/OFF	Set / Get	0: OFF 1: ON	0	---	---
139		NG error code output	Set / Get	0: OFF 1: ON	1	---	---
141 ^{*1}		Error string	Set / Get	20 characters max.	NG	---	---
142		Partial output ON/OFF	Set / Get	0: No 1: Yes	0	---	---
143		Output end digit	Set / Get	1 to 128	128	---	---
144		Output beginning digit	Set / Get	1 to 128	1	---	---
146	Measurement conditions	Reading speed	Set / Get	0: Fixed 1: Variable	1	---	---
150 ^{*1}		Format character string 0	Set / Get	32 characters max.		---	---
151 ^{*1}		Format character string 1	Set / Get	32 characters max.		---	---
152 ^{*1}		Format character string 2	Set / Get	32 characters max.		---	---
153 ^{*1}		Format character string 3	Set / Get	32 characters max.		---	---
154 ^{*1}		Teach mode	Set / Get	0: Simple teach 1: Correct string	1	---	---
155 ^{*1}		Correct string (L.1)	Set / Get	32 characters max.		---	---
156 ^{*1}		Correct string (L.2)	Set / Get	32 characters max.		---	---
157 ^{*1}		Correct string (L.3)	Set / Get	32 characters max.		---	---
158 ^{*1}		Correct string (L.4)	Set / Get	32 characters max.		---	---
160		Dictionary reference	Set / Get	-1: None 0 to 31	-1	---	---
170	Output character set	String output ON/OFF (memory link)	Set / Get	0: OFF 1: ON	0	---	---
171		NG error code output (memory link)	Set / Get	0: OFF 1: ON	1	---	---
172		Partial output ON/OFF (memory link)	Set / Get	0: OFF 1: ON	0	---	---

External reference number	Category	Data name	Set / Get	Data range	Default	Expression text string	Logged data/Judgement parameter
173	Output character set	Output end digit (memory link)	Set / Get	1 to 128	128	---	---
174		Output beginning digit (memory link)	Set / Get	1 to 128	1	---	---
195		Max width setting	Set / Get	0: OFF 1: ON	0	---	---
196	Measurement condition	Max width	Set / Get	0 to 9999	0	---	---
197		Max height	Set / Get	0 to 9999	0	---	---
198		Min height	Set / Get	0 to 100	50	---	---
250	Judgement conditions	Number of characters upper limit (L.1)	Set / Get	0 to 32	32	---	---
251		Number of characters upper limit (L.2)	Set / Get	0 to 32	32	---	---
252		Number of characters upper limit (L.3)	Set / Get	0 to 32	32	---	---
253		Number of characters upper limit (L.4)	Set / Get	0 to 32	32	---	---
260		Number of characters lower limit (L.1)	Set / Get	0 to 32	0	---	---
261		Number of characters lower limit (L.2)	Set / Get	0 to 32	0	---	---
262		Number of characters lower limit (L.3)	Set / Get	0 to 32	0	---	---
263		Number of characters lower limit (L.4)	Set / Get	0 to 32	0	---	---
300		Logging conditions	Data logging count	Set / Get	1 to 128	128	---
310	Data logging switch (unit)		Set / Get	0: Data logging OFF 1: Data logging ON	1	---	---
311	Data logging switch (judgement)		Set / Get	0: Data logging OFF 1: Data logging ON	1	---	---
312	Data logging switch (minimum similarity)		Set / Get	0: Data logging OFF 1: Data logging ON	1	---	---
313	Data logging switch (minimum stability)		Set / Get	0: Data logging OFF 1: Data logging ON	1	---	---
314	Data logging switch (number of characters 1)		Set / Get	0: Data logging OFF 1: Data logging ON	1	---	---
315	Data logging switch (number of characters 2)		Set / Get	0: Data logging OFF 1: Data logging ON	1	---	---
316	Data logging switch (number of characters 3)		Set / Get	0: Data logging OFF 1: Data logging ON	1	---	---
317	Data logging switch (number of characters 4)		Set / Get	0: Data logging OFF 1: Data logging ON	1	---	---
318	Data logging switch (similarity (individual))	Set / Get	0: Data logging OFF 1: Data logging ON	1	---	---	
319	Logging conditions	Data logging switch (stability (individual))	Set / Get	0: Data logging OFF 1: Data logging ON	1	---	---

External reference number	Category	Data name	Set / Get	Data range	Default	Expression text string	Logged data/Judgement parameter
400	Verification conditions	Verification master data	Set / Get	-1: OFF 0: All master data, 1 to 32: Selected master data	-1	---	---
401		Matching mode	Set / Get	0: Direct input 1: Calendar matching 2: Code matching	0	---	---
410		Auto master data number	Set / Get	-1: OFF 0 to 31: Selected master data	-1	---	---
420	Judgement conditions	Judgement mode	Set / Get	0: All 1: Individual	0	---	---
450+N (N=0 to 9)		Individual characters (number)	Set / Get	0: Disable 1: Enable	1	---	---
450+N (N=10 to 35)		Individual characters (Alphabet)	Set / Get	0: Disable 1: Enable	1	---	---
450+N (N=36 to 39)		Individual characters (Symbol)	Set / Get	0: Disable 1: Enable	1	---	---
500	Verification conditions	Selected master data number	Set / Get	0 to 31	0	---	---
700	Display settings	Similarity display	Set / Get	0: Display 1: Do not display	0	---	---
701		Stability display	Set / Get	0: Display 1: Do not display	0	---	---
702		Number of read characters display	Set / Get	0: Display 1: Do not display	1	---	---
703		Character display	Set / Get	0: Display 1: Do not display	0	---	---
704		Character count display Ver.2.10 or later	Set / Get		0	---	---
705		Characters display Ver.2.10 or later	Set / Get	0: Display 1: Do not display	0	---	---
706		Verification string display Ver.2.10 or later	Set / Get		0	---	---
800+N (N=0 to 39)	Judgement conditions	Similarity upper limit	Set / Get	0 to 100	100	---	---
850+N (N=0 to 39)		Similarity lower limit	Set / Get	0 to 100	60	---	---
900+N (N=0 to 39)		Stability upper limit	Set / Get	0 to 100	100	---	---
950+N (N=0 to 39)		Stability lower limit	Set / Get	0 to 100	10	---	---
1001	Verification conditions	Reference unit number 0	Set / Get	-1: OFF 0 to 31	-1	---	---

External reference number	Category	Data name	Set / Get	Data range	Default	Expression text string	Logged data/Judgement parameter
1002+N × 2 (N = 0 to 3)	Verification on conditions	Verification end digit 0N	Set / Get	1 to 1024	1024	---	---
1003+N × 2 (N = 0 to 3)		Verification beginning digit 0N	Set / Get	1 to 1024	1	---	---
1011+N × 2 (N = 0 to 3) ^{*1}		Master data 0N	Set / Get	32 characters max.		---	---
1021		Reference unit number 1	Set / Get	-1: OFF 0 to 31	-1	---	---
1022+N × 2 (N = 0 to 3)		Verification end digit 1N	Set / Get	1 to 1024	1024	---	---
1023+N × 2 (N = 0 to 3)		Verification beginning digit 1N	Set / Get	1 to 1024	1	---	---
1031+N × 2 (N = 0 to 3) ^{*1}		Master data 1N	Set / Get	32 characters max.		---	---
1041		Reference unit number 2	Set / Get	-1: OFF 0 to 31	-1	---	---
1042+N × 2 (N = 0 to 3)		Verification end digit 2N	Set / Get	1 to 1024	1024	---	---
1043+N × 2 (N = 0 to 3)		Verification beginning digit 2N	Set / Get	1 to 1024	1	---	---
1051+N × 2 (N = 0 to 3) ^{*1}		Master data 2N	Set / Get	32 characters max.		---	---
1061		Reference unit number 3	Set / Get	-1: OFF, 0 to 31	-1		
1062+N × 2 (N = 0 to 3)		Verification end digit 3N	Set / Get	1 to 1024	1024	---	---
1063+N × 2 (N = 0 to 3)		Verification beginning digit 3N	Set / Get	1 to 1024	1	---	---
1071+N × 2 (N = 0 to 3) ^{*1}		Master data 3N	Set / Get	32 characters max.		---	---
1081		Reference unit number 4	Set / Get	-1: OFF 0 to 31	-1		
1082+N × 2 (N = 0 to 3)	Verification end digit 4N	Set / Get	1 to 1024	1024	---	---	
1083+N × 2 (N = 0 to 3)	Verification beginning digit 4N	Set / Get	1 to 1024	1	---	---	
1091+N × 2 (N = 0 to 3) ^{*1}	Master data 4N	Set / Get	32 characters max.		---	---	
1101	Reference unit number 5	Set / Get	-1: OFF 0 to 31	-1			

External reference number	Category	Data name	Set / Get	Data range	Default	Expression text string	Logged data/Judgement parameter
1102+N × 2 (N = 0 to 3)	Verification on conditions	Verification end digit 5N	Set / Get	1 to 1024	1024	---	---
1103+N × 2 (N = 0 to 3)		Verification beginning digit 5N	Set / Get	1 to 1024	1	---	---
1111+N × 2 (N = 0 to 3) ^{*1}		Master data 5N	Set / Get	32 characters max.		---	---
1121		Reference unit number 6	Set / Get	-1: OFF, 0 to 31	-1		
1122+N × 2 (N = 0 to 3)		Verification end digit 6N	Set / Get	1 to 1024	1024	---	---
1123+N × 2 (N = 0 to 3)		Verification beginning digit 6N	Set / Get	1 to 1024	1	---	---
1131+N × 2 (N = 0 to 3) ^{*1}		Master data 6N	Set / Get	32 characters max.		---	---
1141		Reference unit number 7	Set / Get	-1: OFF, 0 to 31	-1		
1142+N × 2 (N = 0 to 3)		Verification end digit 7N	Set / Get	1 to 1024	1024	---	---
1143+N × 2 (N = 0 to 3)		Verification beginning digit 7N	Set / Get	1 to 1024	1	---	---
1151+N × 2 (N = 0 to 3) ^{*1}		Master data 7N	Set / Get	32 characters max.		---	---
1161		Reference unit number 8	Set / Get	-1: OFF, 0 to 31	-1		
1162+N × 2 (N = 0 to 3)		Verification end digit 8N	Set / Get	1 to 1024	1024	---	---
1163+N × 2 (N = 0 to 3)		Verification beginning digit 8N	Set / Get	1 to 1024	1	---	---
1171+N × 2 (N = 0 to 3) ^{*1}		Master data 8N	Set / Get	32 characters max.		---	---
1181		Reference unit number 9	Set / Get	-1: OFF, 0 to 31	-1		
1182+N × 2 (N = 0 to 3)	Verification end digit 9N	Set / Get	1 to 1024	1024	---	---	
1183+N × 2 (N = 0 to 3)	Verification beginning digit 9N	Set / Get	1 to 1024	1	---	---	
1191+N × 2 (N = 0 to 3) ^{*1}	Master data 9N	Set / Get	32 characters max.		---	---	
1201	Reference unit number 10	Set / Get	-1: OFF, 0 to 31	-1			

External reference number	Category	Data name	Set / Get	Data range	Default	Expression text string	Logged data/Judgement parameter
1202+N × 2 (N = 0 to 3)	Verification conditions	Verification end digit 10N	Set / Get	1 to 1024	1024	---	---
1203+N × 2 (N = 0 to 3)		Verification beginning digit 10N	Set / Get	1 to 1024	1	---	---
1211+N × 2 (N = 0 to 3) ^{*1}		Master data 10N	Set / Get	32 characters max.		---	---
1221		Reference unit number 11	Set / Get				
1222+N × 2 (N = 0 to 3)		Verification end digit 11N	Set / Get	1 to 1024	1024	---	---
1223+N × 2 (N = 0 to 3)		Verification beginning digit 11N	Set / Get	1 to 1024	1	---	---
1231+N × 2 (N = 0 to 3) ^{*1}		Master data 11N	Set / Get	32 characters max.		---	---
1241		Reference unit number 12	Set / Get	-1: OFF, 0 to 31	-1		
1242+N × 2 (N = 0 to 3)		Verification end digit 12N	Set / Get	1 to 1024	1024	---	---
1243+N × 2 (N = 0 to 3)		Verification beginning digit 12N	Set / Get	1 to 1024	1	---	---
1251+N × 2 (N = 0 to 3) ^{*1}		Master data 12N	Set / Get	32 characters max.		---	---
1261		Reference unit number 13	Set / Get	-1: OFF, 0 to 31	-1		
1262+N × 2 (N = 0 to 3)		Verification end digit 13N	Set / Get	1 to 1024	1024	---	---
1263+N × 2 (N = 0 to 3)		Verification beginning digit 13N	Set / Get	1 to 1024	1	---	---
1271+N × 2 (N = 0 to 3) ^{*1}		Master data 13N	Set / Get	32 characters max.		---	---
1281	Reference unit number 14	Set / Get	-1: OFF 0 to 31	-1			
1282+N × 2 (N = 0 to 3)	Verification end digit 14N	Set / Get	1 to 1024	1024	---	---	
1283+N × 2 (N = 0 to 3)	Verification beginning digit 14N	Set / Get	1 to 1024	1	---	---	
1291+N × 2 (N = 0 to 3) ^{*1}	Master data 14N	Set / Get	32 characters max.		---	---	
1301	Reference unit number 15	Set / Get	-1: OFF, 0 to 31	-1			
1302+N × 2 (N = 0 to 3)	Verification end digit 15N	Set / Get	1 to 32	32	---	---	

External reference number	Category	Data name	Set / Get	Data range	Default	Expression text string	Logged data/Judgement parameter
1303+N × 2 (N = 0 to 3)	Verification conditions	Verification beginning digit 15N	Set / Get	1 to 32	1	---	---
1311+N × 2 (N = 0 to 3) ^{*1}		Master data 15N	Set / Get	32 characters max.		---	---
1321		Reference unit number 16	Set / Get	-1: OFF 0 to 31	-1		
1322+N × 2 (N = 0 to 3)		Verification end digit 16N	Set / Get	1 to 1024	1024	---	---
1323+N × 2 (N = 0 to 3)		Verification beginning digit 16N	Set / Get	1 to 1024	1	---	---
1331+N × 2 (N = 0 to 3) ^{*1}		Master data 16N	Set / Get	32 characters max.		---	---
1341		Reference unit number 17	Set / Get	-1: OFF, 0 to 31	-1		
1342+N × 2 (N = 0 to 3)		Verification end digit 17N	Set / Get	1 to 32	32	---	---
1343+N × 2 (N = 0 to 3)		Verification beginning digit 17N	Set / Get	1 to 32	1	---	---
1351+N × 2 (N = 0 to 3) ^{*1}		Master data 17N	Set / Get	32 characters max.		---	---
1361		Reference unit number 18	Set / Get	-1: OFF, 0 to 31	-1		
1362+N × 2 (N = 0 to 3)		Verification end digit 18N	Set / Get	1 to 32	32	---	---
1363+N × 2 (N = 0 to 3)		Verification beginning digit 18N	Set / Get	1 to 32	1	---	---
1371+N × 2 (N = 0 to 3) ^{*1}		Master data 18N	Set / Get	32 characters max.		---	---
1381		Reference unit number 19	Set / Get	-1: OFF, 0 to 31	-1		
1382+N × 2 (N = 0 to 3)		Verification end digit 19N	Set / Get	1 to 32	32	---	---
1383+N × 2 (N = 0 to 3)		Verification beginning digit 19N	Set / Get	1 to 32	1	---	---
1391+N × 2 (N = 0 to 3) ^{*1}		Master data 19N	Set / Get	32 characters max.		---	---
1401		Reference unit number 20	Set / Get	-1: OFF, 0 to 31	-1		
1402+N × 2 (N = 0 to 3)		Verification end digit 20N	Set / Get	1 to 32	32	---	---

External reference number	Category	Data name	Set / Get	Data range	Default	Expression text string	Logged data/Judgement parameter
1403+N × 2 (N = 0 to 3)	Verification conditions	Verification beginning digit 20N	Set / Get	1 to 32	1	---	---
1411+N × 2 (N = 0 to 3) ^{*1}		Master data 20N	Set / Get	32 characters max.		---	---
1421		Reference unit number 21	Set / Get	-1: OFF, 0 to 31	-1		
1422+N × 2 (N = 0 to 3)		Verification end digit 21N	Set / Get	1 to 1024	1024	---	---
1423+N × 2 (N = 0 to 3)		Verification beginning digit 21N	Set / Get	1 to 1024	1	---	---
1431+N × 2 (N = 0 to 3) ^{*1}		Master data 21N	Set / Get	32 characters max.		---	---
1441		Reference unit number 22	Set / Get	-1: OFF, 0 to 31	-1		
1442+N × 2 (N = 0 to 3)		Verification end digit 22N	Set / Get	1 to 1024	1024	---	---
1443+N × 2 (N = 0 to 3)		Verification beginning digit 22N	Set / Get	1 to 1024	1	---	---
1451+N × 2 (N = 0 to 3) ^{*1}		Master data 22N	Set / Get	32 characters max.		---	---
1461		Reference unit number 23	Set / Get	-1: OFF, 0 to 31	-1		
1462+N × 2 (N = 0 to 3)		Verification end digit 23N	Set / Get	1 to 1024	1024	---	---
1463+N × 2 (N = 0 to 3)		Verification beginning digit 23N	Set / Get	1 to 1024	1	---	---
1471+N × 2 (N = 0 to 3) ^{*1}		Master data 23N	Set / Get	32 characters max.		---	---
1481		Reference unit number 24	Set / Get	-1: OFF, 0 to 31	-1		
1482+N × 2 (N = 0 to 3)		Verification end digit 24N	Set / Get	1 to 1024	1024	---	---
1483+N × 2 (N = 0 to 3)		Verification beginning digit 24N	Set / Get	1 to 1024	1	---	---
1491+N × 2 (N = 0 to 3) ^{*1}		Master data 24N	Set / Get	32 characters max.		---	---
1501		Reference unit number 25	Set / Get	-1: OFF, 0 to 31	-1		
1502+N × 2 (N = 0 to 3)		Verification end digit 25N	Set / Get	1 to 1024	1024	---	---

External reference number	Category	Data name	Set / Get	Data range	Default	Expression text string	Logged data/Judgement parameter
1503+N × 2 (N = 0 to 3)	Verification conditions	Verification beginning digit 25N	Set / Get	1 to 1024	1	---	---
1511+N × 2 (N = 0 to 3) ^{*1}		Master data 25N	Set / Get	32 characters max.		---	---
1521		Reference unit number 26	Set / Get	-1: OFF, 0 to 31	-1		
1522+N × 2 (N = 0 to 3)		Verification end digit 26N	Set / Get	1 to 1024	1024	---	---
1523+N × 2 (N = 0 to 3)		Verification beginning digit 26N	Set / Get	1 to 1024	1	---	---
1531+N × 2 (N = 0 to 3) ^{*1}		Master data 26N	Set / Get	32 characters max.		---	---
1541		Reference unit number 27	Set / Get	-1: OFF, 0 to 31	-1		
1542+N × 2 (N = 0 to 3)		Verification end digit 27N	Set / Get	1 to 1024	1024	---	---
1543+N × 2 (N = 0 to 3)		Verification beginning digit 27N	Set / Get	1 to 1024	1	---	---
1551+N × 2 (N = 0 to 3) ^{*1}		Master data 27N	Set / Get	32 characters max.		---	---
1561		Reference unit number 28	Set / Get	-1: OFF 0 to 31	-1		
1562+N × 2 (N = 0 to 3)		Verification end digit 28N	Set / Get	1 to 1024	1024	---	---
1563+N × 2 (N = 0 to 3)		Verification beginning digit 28N	Set / Get	1 to 1024	1	---	---
1571+N × 2 (N = 0 to 3) ^{*1}		Master data 28N	Set / Get	32 characters max.		---	---
1582		Reference unit number 29	Set / Get	-1: OFF, 0 to 31	-1		
1582+N × 2 (N = 0 to 3)		Verification end digit 29N	Set / Get	1 to 1024	1024	---	---
1583+N × 2 (N = 0 to 3)		Verification beginning digit 29N	Set / Get	1 to 1024	1	---	---
1591+N × 2 (N = 0 to 3) ^{*1}		Master data 29N	Set / Get	32 characters max.		---	---
1601		Reference unit number 30	Set / Get	-1: OFF, 0 to 31	-1		
1602+N × 2 (N = 0 to 3)		Verification end digit 30N	Set / Get	1 to 1024	1024	---	---

External reference number	Category	Data name	Set / Get	Data range	Default	Expression text string	Logged data/Judgement parameter
1603+N × 2 (N = 0 to 3)	Verification conditions	Verification beginning digit 30N	Set / Get	1 to 1024	1	---	---
1611+N × 2 (N = 0 to 3) ^{*1}		Master data 30N	Set / Get	32 characters max.		---	---
1621		Reference unit number 31	Set / Get	-1: OFF 0 to 31	-1		
1622+N × 2 (N = 0 to 3)		Verification end digit 31N	Set / Get	1 to 1024	1024	---	---
1623+N × 2 (N = 0 to 3)		Verification beginning digit 31N	Set / Get	1 to 1024	1	---	---
1631+N × 2 (N = 0 to 3) ^{*1}		Master data 31N	Set / Get	32 characters max.		---	---
1701		Reference unit number (in code matching mode)	Set / Get	-1: OFF 0 to 31			
1702+N × 2 (N=0 to 3)		Verification end digit Nth line (in calendar matching mode, or code matching mode)	Set / Get	1 to 1024	1024	---	---
1703+N × 2 (N=0 to 3)		Verification beginning digit Nth line (in calendar matching mode, or code matching mode)	Set / Get	1 to 1024	1	---	---
1711+N × 2 (N=0 to 3) to 1		Master data Nth line (in calendar matching mode, or code matching mode)	Set / Get	32 characters max.		---	---
1720+N × 2 (N=0 to 3)		Verification line select Nth line (in code matching mode)	Set / Get	0: Disable 1: Enable	0	---	---
1800 ^{*1}		Code data file name	Set / Get	32 characters max.	code	---	---
1825		Period setting: Year	Set / Get	0 to 99	0	---	---
1826		Period setting: Month	Set / Get	0 to 99	0	---	---
1827		Period setting: Day	Set / Get	-999 to 999	0	---	---
1828		Auto update	Set / Get	0: Don't update 1: First update 2: Always update	2	---	---
1829		Zero suppress	Set / Get	0: 0 1: Space	0	---	---
1830		Data calc. order	Set / Get	0: Month→Day 1: Day→Month	0	---	---
1831		Month end adjust	Set / Get	0: Last day of current month 1: First day of next month 2: Gap day of next month	0	---	---
1832	Ahead margin	Set / Get	0 to 99	0	---	---	
1833	Back margin	Set / Get	0 to 99	0	---	---	

External reference number	Category	Data name	Set / Get	Data range	Default	Expression text string	Logged data/Judgement parameter
2000	Measurement result	Number of read characters on line 1	Get only	0 to 32	0	---	---
2001		Number of read characters on line 2	Get only	0 to 32	0	---	---
2002		Number of read characters on line 3	Get only	0 to 32	0	---	---
2003		Number of read characters on line 4	Get only	0 to 32	0	---	---
2100		Read character string on line 1	Get only	32 characters max.	---	---	---
2101*1		Read character string on line 2	Get only	32 characters max.	---	---	---
2102*1		Read character string on line 3	Get only	32 characters max.	---	---	---
2103*1		Read character string on line 4	Get only	32 characters max.	---	---	---
2500+N (N= 0 to 127*1)		Individual read character	Get only	1 character	---	---	---
3000+N (N= 0 to 127)		Individual similarity	Get only	0 to 100	0	---	---
3500+N (N= 0 to 127)		Individual stability	Get only	0 to 100	0	---	---

*1: To acquire the detected text string, use the ITEMDATA2 command.

Bar code (FQ2-S4 series only)

External reference number	Category	Data name	Set / Get	Data range	Default	Expression text string	Logged data/Judgement parameter
0	Measurement result	Judgement	Get only	-2: No judgement (not measured), 0: Judgement is OK, 1: Judgement is NG, -16: Measurement timeout error	-2	JG	Logged data
5		Index No.	Get only	-2: No verification pattern, or reading error -1: Verification is NG, 0 to 31: Master data No.	-2	IN	---
6		Num. of characters	Get only	0 to 1024	0	N	Logged data
7*1		Characters	Get only	32 characters max.	0	---	---
103	Output parameter	Reflect	Get only	0: Yes, 1: No	0	---	---
121	Verification condition	Verified master data	Set / Get	-1: OFF 0: Verify all master data 1: Verify master data 0 2: Verify master data 1 ⋮ 31: Verify master data 31	-1	---	---
122		Partial verif. on/off	Set / Get	0: No 1: Yes	0	---	---

External reference number	Category	Data name	Set / Get	Data range	Default	Expression text string	Logged data/ Judgement parameter
123	Verification condition	Last compared digit	Set / Get	1 to 1024	1024	---	---
124		First compared digit	Set / Get	1 to 1024	1	---	---
125	Output parameter	String output on/off	Set / Get	0: None 1: Enable	0	---	---
127 ^{*1}		Error string	Set / Get	20 characters max	NG	---	---
128		Partial output on/off	Set / Get	0: None 1: Enable	0	---	---
129		Output last digit	Set / Get	1 to 1024	1024	---	---
130		Output first digit	Set / Get	1 to 1024	1	---	---
131	Measurement condition	Code type	Set / Get	0: JAN/EAN/UPC 1: Code 39 2: Codabar 3: ITF 4: Code 93 5: Code128/GS1-128 6: GS1 DataBar 7: Pharmacode	0	---	---
132		Timeout time (ms)	Set / Get	1 to 9999	9999	---	---
133		Check digit on/off	Set / Get	0: None 1: Enable	1	---	---
134		Composite codes on/off	Set / Get	0: None 1: Enable	0	---	---
135	Measurement result	Direction	Set / Get	0: Horizontal mode 1: Vertical mode	0	---	---
136		Reverse on/off	Set / Get	0: None 1: Enable	0	---	---
141		Code color	Set / Get	0: Black 1: White	0	---	---
150	Verification condition	Selected master number	Set / Get	1 to 31	0	---	---
152		Auto master data number	Set / Get	0 to 31: Master data number -1: OFF	-1	---	---
160	Output parameter	NG error code output	Set / Get	0: OFF 1: ON	1	---	---
170		String output ON/OFF (memory link)	Set / Get	0: OFF 1: ON	0	---	---
171		NG error code output (memory link)	Set / Get	0: OFF 1: ON	1	---	---
172		Partial output ON/OFF (memory link)	Set / Get	0: OFF 1: ON	0	---	---
173		Output end digit (memory link)	Set / Get	1 to 1024	1024	---	---
174		Output beginning digit (memory link)	Set / Get	1 to 1024	1	---	---
202+3N (N=0 to 31)	Verification condition	Master data N	Set / Get	32 characters max.	None	---	---
300+N (N=0 to 31)		Reference unit number N	Set / Get	0 to 31	0	---	---

External reference number	Category	Data name	Set / Get	Data range	Default	Expression text string	Logged data/Judgement parameter
410	Logging conditions	Data logging switch for unit	Set / Get	0: Data logging OFF 1: Data logging ON	1	---	---
411		Data logging switch for judgement	Set / Get	0: Data logging OFF 1: Data logging ON	1	---	---
412		Data logging switch for number of characters	Set / Get	0: Data logging OFF 1: Data logging ON	1	---	---
500	Display setting	Number of characters display	Set / Get	0: OFF 1: ON	0	---	---
501		Character display	Set / Get	0: ON 1: OFF	0	---	---

*1 Use the ITEMDATA2 command to set and/or acquire a text string.

2D-code (FQ2-S4 series only)

External reference number	Category	Data name	Set / Get	Data range	Default	Expression text string	Logged data/Judgement parameter
0	Measurement result	Judgement	Get only	-2: Not measured, 0: Judgement is OK, 1: Judgement is NG, -16: Measurement timeout error	-2	JG	Logged data
5		Index No.	Get only	-2: No verification pattern, or reading error -1: Verification is NG, 0 to 31: Master data No.	-2	IN	---
6		Num. of characters	Get only	0 to 1024	0	N	Logged data
7 ^{*1}		Characters	Get only	32 characters max.	0	---	---
50		Overall quality	Get only	0 to 4	0	GD0	Logged data
51		Decode	Get only	0 to 4	0	GD1	Logged data
52		Cell Contrast	Get only	0 to 4	0	GD2	Logged data
53		Cell Modulation	Get only	0 to 4	0	GD3	Logged data
54		Fixed pattern damage	Get only	0 to 4	0	GD4	Logged data
55		Axial nonuniformity	Get only	0 to 4	0	GD5	Logged data
56		Grid nonuniformity	Get only	0 to 4	0	GD6	Logged data
57		Unused err. Corr.	Get only	0 to 4	0	GD7	Logged data
58		Print scale	Get only	0 to 4	0	GD8	Logged data
59		Print Scale X	Get only	0 to 4	0	GD9	Logged data
60	Print Scale Y	Get only	0 to 4	0	GD10	Logged data	
103	Output parameter	Reflect	Set / Get	0: Yes, 1: No	0	---	---

External reference number	Category	Data name	Set / Get	Data range	Default	Expression text string	Logged data/Judgement parameter
121	Verification condition	Verified master data	Set / Get	-1: OFF 0: Verify all master data 1: Verify master data 0 2: Verify master data 1 ⋮	0	---	---
122		Partial verif. on/off	Set / Get	0: No 1: Yes	0	---	---
123		Last compared digit	Set / Get	1 to 1024	1024	---	---
124		First compared digit	Set / Get	1 to 1024	1	---	---
125	Output parameter	String output on/off	Set / Get	0: None 1: Enable	0	---	---
126		Error string size (bytes)	Set / Get	1 to 20	2	---	---
127 ^{*1}		Error string	Set / Get	20 characters max.	NG	---	---
128		Partial output on/off	Set / Get	0: None 1: Enable	0	---	---
129		Output last digit	Set / Get	1 to 1024	1024	---	---
130		Output first digit	Set / Get	1 to 1024	1	---	---
131	Measurement condition	Code type	Set / Get	0: Data Matrix 1: QR Code 2: MicroQR Code 3: PDF417 4: MicroPDF417	0	---	---
132		Timeout time (ms)	Set / Get	1 to 9999	9999	---	---
133		Reverse (Data Matrix, QR Code, Micro QR Code only)	Set / Get	0: Normal 1: Reverse	0	---	---
134		Code color (Data Matrix, QR Code, Micro QR Code only)	Set / Get	0: Black 1: White 2: Auto	2	---	---
135	Measurement result	Shape (DataMatrix only)	Set / Get	0: Square 1: Square or Rect.	0	---	---
150	Verification condition	Selected master number	Set / Get	0 to 31	0	---	---
152		Auto master data number	Set / Get	0 to 31: Master data number -1: OFF	-1	---	---
160	Output parameter	NG error code output	Set / Get	0: OFF 1: ON	1	---	---
167	Judgement condition threshold	Print quality threshold upper limit	Set / Get	0 to 4	4	---	Judgement condition
168		Print quality threshold lower limit	Set / Get	0 to 4	0	---	Judgement condition

External reference number	Category	Data name	Set / Get	Data range	Default	Expression text string	Logged data/Judgement parameter
170	Output parameter	String output ON/OFF (memory link)	Set / Get	0: OFF 1: ON	0	---	---
171		NG error code output (memory link)	Set / Get	0: OFF 1: ON	1	---	---
172		Partial output ON/OFF (memory link)	Set / Get	0: OFF 1: ON	0	---	---
173		Output end digit (memory link)	Set / Get	1 to 1024	1024	---	---
174		Output beginning digit (memory link)	Set / Get	1 to 1024	1	---	---
180	Measurement condition	GS conversion	Set / Get	0: OFF 1: ON	0	---	---
181		Replacement character string	Set / Get	Maximum 16 characters	None	---	---
186		Print quality	Set / Get	0: OFF 1: ON	0	---	---
190		Grid correction (MicroQR Code)	Set / Get	0: OFF 1: ON	0	---	---
202+3N (N=0 to 31) ^{*1}	Verification condition	Master data N	Set / Get	32 characters max.	None	---	---
300+N (N=0 to 31)		Reference unit number N	Set / Get	0 to 31	0	---	---
410	Logging conditions	Data logging switch for unit	Set / Get	0: Data logging OFF 1: Data logging ON	1	---	---
411		Data logging switch for judgement	Set / Get	0: Data logging OFF 1: Data logging ON	1	---	---
412		Data logging switch for number of characters	Set / Get	0: Data logging OFF 1: Data logging ON	1	---	---
440		Data logging switch (overall quality)	Set / Get	0: Data logging OFF 1: Data logging ON	1	---	---
441		Data logging switch (decode)	Set / Get	0: Data logging OFF 1: Data logging ON	0	---	---
442		Data logging switch (cell contrast)	Set / Get	0: Data logging OFF 1: Data logging ON	0	---	---
443		Data logging switch (cell modulation)	Set / Get	0: Data logging OFF 1: Data logging ON	0	---	---
444		Data logging switch (fixed pattern damage)	Set / Get	0: Data logging OFF 1: Data logging ON	0	---	---
445		Data logging switch (axial nonuniformity)	Set / Get	0: Data logging OFF 1: Data logging ON	0	---	---
446		Data logging switch (grid nonuniformity)	Set / Get	0: Data logging OFF 1: Data logging ON	0	---	---
447		Data logging switch (unused error correction)	Set / Get	0: Data logging OFF 1: Data logging ON	0	---	---
448		Data logging switch (print scale)	Set / Get	0: Data logging OFF 1: Data logging ON	0	---	---
449		Data logging switch (print scale X)	Set / Get	0: Data logging OFF 1: Data logging ON	0	---	---
450		Data logging switch (print scale Y)	Set / Get	0: Data logging OFF 1: Data logging ON	0	---	---

External reference number	Category	Data name	Set / Get	Data range	Default	Expression text string	Logged data/Judgement parameter
500	Display setting	Number of characters display	Set / Get	0: ON 1: OFF	0	---	---
501		Character display	Set / Get	0: ON 1: OFF	0	---	---
520		Display ON/OFF (overall quality)	Set / Get	0: ON 1: OFF	0	---	---
521		Display ON/OFF (decode)	Set / Get	0: ON 1: OFF	0	---	---
522		Display ON/OFF (cell contrast)	Set / Get	0: ON 1: OFF	0	---	---
523		Display ON/OFF (cell modulation)	Set / Get	0: ON 1: OFF	0	---	---
524		Display ON/OFF (fixed pattern damage)	Set / Get	0: ON 1: OFF	0	---	---
525		Display ON/OFF (axial nonuniformity)	Set / Get	0: ON 1: OFF	0	---	---
526		Display ON/OFF (grid nonuniformity)	Set / Get	0: ON 1: OFF	0	---	---
527		Display ON/OFF (unused error correction)	Set / Get	0: ON 1: OFF	0	---	---
528		Display ON/OFF (print scale)	Set / Get	0: ON 1: OFF	0	---	---
529		Display ON/OFF (print scale X)	Set / Get	0: ON 1: OFF	0	---	---
530		Display ON/OFF (print scale Y)	Set / Get	0: ON 1: OFF	0	---	---

*1 Use the ITEMDATA2 command to set and/or acquire a text string.

2D Codes (DPM) (FQ2-S4 series only)

External reference number	Category	Data name	Set / Get	Data range	Default	Expression text string	Logged
0	Measurement result	Judgment	Get only	-2: No judgment (not inspected) 0: Judgment result OK -1: Judgment result NG -16: Inspection timeout error	-2	JG	Logged
5		Num. of char.	Get only	0 to 1024	0	N	Logged
6 ^{*1}		Characters	Get only	Text string	---	---	---
8		Cell Recog. Rate	Get only	0 to 100	0	E	Logged
9		Contrast	Get only	0 to 100	0	C	Logged
10		Focus	Get only	0 to 100	0	F	---
17		Index number	Get only	-2: No verification pattern or reading error -1: Verification is NG 0 to 31: Master data No.	-2	IN	---
50		Overall quality	Get only	0 to 4	0	GDA0	Logged
51		Decode	Get only	0 to 4	0	GDA1	Logged
52		Cell Contrast	Get only	0 to 4	0	GDA2	Logged
53		Cell Modulation	Get only	0 to 4	0	GDA3	Logged
54		Fixed pattern damage	Get only	0 to 4	0	GDA4	Logged
55		Axial nonuniformity	Get only	0 to 4	0	GDA5	Logged
56		Grid nonuniformity	Get only	0 to 4	0	GDA6	Logged
57	Unused err. Corr.	Get only	0 to 4	0	GDA7	Logged	
103	Output parameter	Reflect	Set / Get	0: Yes, 1: No	0	---	---

External reference number	Category	Data name	Set / Get	Data range	Default	Expression text string	Logged
120	Measurement condition	Code type	Set / Get	0: Auto 1: DataMatrix 2: QR Code	0	---	---
121		Code color	Set / Get	0: Auto 1: Black 2: White	0	---	---
122		Cell (DataMatrix Square)	Set / Get	0: Auto 1: 10 × 10 2: 12 × 12 ... 16: 16 × 64	0	---	---
123		Cell (DataMatrix Rectangle)	Set / Get	0: Auto 1: 8 × 18 2: 8 × 32 3: 12 × 26 4: 12 × 36 5: 16 × 36 6: 16 × 48	0	---	---
124		Cell (QR Code)	Set / Get	0: Auto 1: 21 × 21 2: 25 × 25 ... 10: 57 × 57	0	---	---
125		Code shape (DataMatrix)	Set / Get	0: Auto 1: Square 2: Rectangle	0	---	---
127		Size	Set / Get	50 to 480	480	---	---
128		Reverse	Set / Get	0: Auto 1: Normal 2: Reverse	0	---	---
129		QR Code Model	Set / Get	0: Auto 1: Model 1 2: Model 2	0	---	---
130		Measurement result	Error Correction Level	Set / Get	0: Auto 1: M (15%) 2: L (7%) 3: H (30%) 4: Q (25%)	0	---
131	Timeout time (ms)		Set / Get	1 to 9999	9999	---	---
132	Fast mode		Set / Get	0: OFF 1: ON	0	---	---
133	Output parameter	String output on/off	Set / Get	0: OFF 1: ON	0	---	---
134		Partial output on/off	Set / Get	0: OFF 1: ON	0	---	---
135		Output end digit	Set / Get	1 to 1024	1024	---	---
136		Output starting digit	Set / Get	1 to 1024	1	---	---
137	Measurement result	Auto length	Set / Get	0: OFF 1: ON	1	---	---
138	Output parameter	NG String output on/off	Set / Get	0: OFF 1: ON	0	---	---
140		Error string	Set / Get	0: OFF 1: ON	0	---	---

External reference number	Category	Data name	Set / Get	Data range	Default	Expression text string	Logged
142	Verification condition	Verification master data	Set / Get	-1: OFF 0: All master data 1: Master data 0 verification 2: Master data 1 verification : 32: Master data 31 verification	-1	---	---
143		Partial verification ON/OFF	Set / Get	0: No 1: Yes	0	---	---
144		Verification end digit	Set / Get	1 to 1024	1024	---	---
145		Verification beginning digit	Set / Get	1 to 1024	1	---	---
150		Selected master number	Set / Get	0 to 31	0	---	---
152		Auto master data number	Set / Get	0 to 31: Master data number -1: OFF	-1	---	---
161	Judgement condition threshold	Upper limit for cell recognition rate threshold	Set / Get	0 to 100	100	---	Judgement condition
162		Lower limit for cell recognition rate threshold	Set / Get	0 to 100	0	---	Judgement condition
163		Contrast threshold upper limit	Set / Get	0 to 100	100	---	Judgement condition
164		Contrast threshold lower limit	Set / Get	0 to 100	0	---	Judgement condition
165		Focus threshold upper limit	Set / Get	0 to 100	100	---	Judgement condition
166		Focus threshold lower limit	Set / Get	0 to 100	0	---	Judgement condition
167		Threshold upper limit for print quality DPM	Set / Get	0 to 4	4	---	Judgement condition
168		Threshold lower limit for print quality DPM	Set / Get	0 to 4	0	---	Judgement condition
170	Output parameter	String output ON/OFF (memory link)	Set / Get	0: OFF 1: ON	0	---	---
171		NG error code output (memory link)	Set / Get	0: OFF 1: ON	1	---	---
172		Partial output ON/OFF (memory link)	Set / Get	0: OFF 1: ON	0	---	---
173		Output end digit (memory link)	Set / Get	1 to 1024	1024	---	---
174		Output beginning digit (memory link)	Set / Get	1 to 1024	1	---	---
186	Measurement condition	DPM print quality	Set / Get	0: OFF 1: ON	0	---	---
190		Grid correction (Data-Matrix)	Set / Get	0: OFF 1: ON	0	---	---
191		Grid correction (QR codes)	Set / Get	0: OFF 1: ON	0	---	---
202+3×N (N=0 to 31) ¹	Verification condition	Master data N	Set / Get	32 characters max.	---	---	---
300+N (N=0 to 31)		Reference unit number N	Set / Get	0 to 31	0	---	---

External reference number	Category	Data name	Set / Get	Data range	Default	Expression text string	Logged
410	Logging conditions	Data logging switch for unit	Set / Get	0: Data logging OFF 1: Data logging ON	1	---	---
411		Data logging switch for judgement	Set / Get	0: Data logging OFF 1: Data logging ON	1	---	---
412		Data logging switch for number of characters	Set / Get	0: Data logging OFF 1: Data logging ON	1	---	---
413		Data logging switch for cell recognition rate	Set / Get	0: Data logging OFF 1: Data logging ON	1	---	---
414		Data logging switch for contrast	Set / Get	0: Data logging OFF 1: Data logging ON	1	---	---
415		Data logging switch for focus	Set / Get	0: Data logging OFF 1: Data logging ON	1	---	---
440		Data logging switch (overall quality)	Set / Get	0: Data logging OFF 1: Data logging ON	1	---	---
441		Data logging switch (decode)	Set / Get	0: Data logging OFF 1: Data logging ON	0	---	---
442		Data logging switch (cell contrast)	Set / Get	0: Data logging OFF 1: Data logging ON	0	---	---
443		Data logging switch (cell modulation)	Set / Get	0: Data logging OFF 1: Data logging ON	0	---	---
444		Data logging switch (fixed pattern damage)	Set / Get	0: Data logging OFF 1: Data logging ON	0	---	---
445		Data logging switch (axial nonuniformity)	Set / Get	0: Data logging OFF 1: Data logging ON	0	---	---
446		Data logging switch (grid nonuniformity)	Set / Get	0: Data logging OFF 1: Data logging ON	0	---	---
447		Data logging switch (unused error correction)	Set / Get	0: Data logging OFF 1: Data logging ON	0	---	---

External reference number	Category	Data name	Set / Get	Data range	Default	Expression text string	Logged
500	Display setting	Characters display	Set / Get	0: ON 1: OFF	0	---	---
501		Character display	Set / Get	0: ON 1: OFF	0	---	---
502		Cell recognition rate display	Set / Get	0: ON 1: OFF	0	---	---
503		Contrast display	Set / Get	0: ON 1: OFF	0	---	---
504		Focus display	Set / Get	0: ON 1: OFF	0	---	---
520		Display ON/OFF (overall quality)	Set / Get	0: ON 1: OFF	0	---	---
521		Display ON/OFF (decode)	Set / Get	0: ON 1: OFF	0	---	---
522		Display ON/OFF (cell contrast)	Set / Get	0: ON 1: OFF	0	---	---
523		Display ON/OFF (cell modulation)	Set / Get	0: ON 1: OFF	0	---	---
524		Display ON/OFF (fixed pattern damage)	Set / Get	0: ON 1: OFF	0	---	---
525		Display ON/OFF (axial nonuniformity)	Set / Get	0: ON 1: OFF	0	---	---
526		Display ON/OFF (grid nonuniformity)	Set / Get	0: ON 1: OFF	0	---	---
527		Display ON/OFF (unused error correction)	Set / Get	0: ON 1: OFF	0	---	---

*1 To acquire the detected text string, use the ITEMDATA2 command.

Search (FQ2-S1/S2/S3 series or FQ2-S4 series only)

External reference number	Category	Data name	Set / Get	Data range	Default	Expression text string	Logged data/Judgement parameter	
0	Measurement result	Judgement	Get only	-2: No judgement (not measured), 0: Judgement is OK, -1: Judgement is NG, -13: Teaching not performed error, -14: Figure not registered error, -15: Out of range error	-2	JG	Logged data	
5		Correlation	Get only	0 to 100	0	CR[0] to CR[31]	Logged data	
6		Position X	Get only	-99,999.9999 to 99,999.9999	0	X[0] to X[31]	Logged data	
7		Position Y	Get only	-99,999.9999 to 99,999.9999	0	Y[0] to Y[31]	Logged data	
8		Angle	Get only	-180 to 180	0	TH[0] to TH[31]	Logged data	
9		Reference X	Get only	-99,999.9999 to 99,999.9999	0	SX	---	
10		Reference Y	Get only	-99,999.9999 to 99,999.9999	0	SY	---	
11		Reference angle	Get only	-180 to 180	0	ST	---	
12		Detection coordinate X	Get only	-99,999.9999 to 99,999.9999	0	RX	---	
13		Detection coordinate Y	Get only	-99,999.9999 to 99,999.9999	0	RY	---	
14			Count	Get only	0 to 32	0	C	Logged data
103		Output parameter	Reflect	Set / Get	0: Yes 1: No	0	---	---
121	Model region	Rotation	Set / Get	0: Yes 1: No	0	---	---	
122		Rotation angle upper limit	Set / Get	-180 to 180	180	---	---	
123		Rotation angle lower limit	Set / Get	-180 to 180	-180	---	---	
126		Stability	Set / Get	1 to 15	12	---	---	
127		Precision	Set / Get	1 to 3	2	---	---	
132	Detection coordinate	Detection point X	Set / Get	-99,999.9999 to 99,999.9999	0	---	---	
133		Detection point Y	Set / Get	-99,999.9999 to 99,999.9999	0	---	---	
134	Measurement condition	Sub-pixel	Set / Get	0: Yes 1: No	0	---	---	
136	Judgement conditions	Judgement upper limit for search coordinate X	Set / Get	-99,999.9999 to 99,999.9999	99,999.9999	---	Judgement condition	
137		Judgement lower limit for search coordinate X	Set / Get	-99,999.9999 to 99,999.9999	-99,999.9999	---	Judgement condition	
138		Judgement upper limit for search coordinate Y	Set / Get	-99,999.9999 to 99,999.9999	99,999.9999	---	Judgement condition	
139		Judgement lower limit for search coordinate Y	Set / Get	-99,999.9999 to 99,999.9999	-99,999.9999	---	Judgement condition	
140		Judgement upper limit for search angle	Set / Get	-180 to 180	180	---	Judgement condition	

External reference number	Category	Data name	Set / Get	Data range	Default	Expression text string	Logged data/Judgement parameter
141	Judgement conditions	Judgement lower limit for search angle	Set / Get	-180 to 180	-180	---	Judgement condition
142		Judgement upper limit for correlation	Set / Get	0 to 100	100	---	Judgement condition
143		Judgement lower limit for correlation	Set / Get	0 to 100	60	---	Judgement condition
145		Search candidate level	Set / Get	0 to 100	70	---	---
146	Measurement conditions	Sort condition	Set / Get	For Multiple Searches 0: Ascending order of correlation value, 1: Descending order of correlation value, 2: Ascending order of position X, 3: Descending order of position X, 4: Ascending order of position Y, 5: Descending order of position Y	1	---	---
148	Judgement conditions	Judgement upper limit for detection count	Set / Get	0 to 32	32	---	Judgement condition
149		Judgement lower limit for detection count	Set / Get	0 to 32	0	---	Judgement condition
150	Measurement conditions	Multiple output	Set / Get	0: No, 1: Yes	0	---	---
152		Extraction condition, X upper limit	Set / Get	-99,999.9999 to 99,999.9999	99,999.9999	---	---
153		Extraction condition, X lower limit	Set / Get	-99,999.9999 to 99,999.9999	- 99,999.9999	---	---
154		Extraction condition, Y upper limit	Set / Get	-99,999.9999 to 99,999.9999	99,999.9999	---	---
155		Extraction condition, Y lower limit	Set / Get	-99,999.9999 to 99,999.9999	- 99,999.9999	---	---
160		Detection count	Set / Get	1 to 32	32	---	---
300	Logging conditions	Number of data log records	Set / Get	1 to 32	32	---	---
310		Data logging switch for entire unit	Set / Get	0: Data logging OFF 1: Data logging ON	1	---	---
311		Data logging switch for judgement	Set / Get	0: Data logging OFF 1: Data logging ON	1	---	---
312		Data logging switch for correlation	Set / Get	0: Data logging OFF 1: Data logging ON	1	---	---
313	Logging conditions	Data logging switch for position X	Set / Get	0: Data logging OFF 1: Data logging ON	1	---	---
314		Data logging switch for position Y	Set / Get	0: Data logging OFF 1: Data logging ON	1	---	---
315		Data logging switch for measurement angle	Set / Get	0: Data logging OFF 1: Data logging ON	1	---	---
321		Data logging switch for detection count	Set / Get	0: Data logging OFF 1: Data logging ON	1	---	---

External reference number	Category	Data name	Set / Get	Data range	Default	Expression text string	Logged data/Judgement parameter
700	Display settings	Correlation display	Set / Get	0: Display 1: Do not display	0	---	---
701		Position X display	Set / Get	0: Display 1: Do not display	0	---	---
702		Position Y display	Set / Get	0: Display 1: Do not display	0	---	---
703		Measurement angle display	Set / Get	0: Display 1: Do not display	0	---	---
704		Count display	Set / Get	0: Display 1: Do not display	0	---	---
800		Position X display pattern	Set / Get	0: Absolute value 1: Relative value	0	---	---
801		Position Y display pattern	Set / Get	0: Absolute value 1: Relative value	0	---	---
802		Measured angle display pattern	Set / Get	0: Absolute value 1: Relative value	0	---	---

Sensitive Search (FQ2-S1/S2/S3 series or FQ2-S4 series only)

External reference number	Category	Data name	Set / Get	Data range	Default	Expression text string	Logged data/Judgement parameter
0	Measurement result	Judgement	Get only	-2: No judgement (not measured), 0: Judgement is OK, -1: Judgement is NG, -13: Teaching not performed error, -14: Figure not registered error, -15: Out of range error	-2	JG	Logged data
5		Correlation	Get only	0 to 100	0	CR	Logged data
6		Deviation	Get only	Color Camera: 0.000 to 219.9705 Monochrome Camera: 0.000 to 127.000	0	DV	Logged data
7		Measurement position X (search center position)	Get only	-99,999.9999 to 99,999.9999	0	X	Logged data
8		Measurement position Y (search center position)	Get only	-99,999.9999 to 99,999.9999	0	Y	Logged data
9		Angle	Get only	-180 to 180	0	TH	Logged data
10	Measurement result	Detection X	Get only	-99,999.9999 to 99,999.9999	0	RX	Logged data
11		Detection Y	Get only	-99,999.9999 to 99,999.9999	0	RY	Logged data
12		Reference position X	Get only	-99,999.9999 to 99,999.9999	0	SX	Logged data
13		Reference position Y	Get only	-99,999.9999 to 99,999.9999	0	SY	Logged data
14		Reference angle	Get only	-180 to 180	0	ST	Logged data
15		NG sub-region	Get only	0 to 100	0	CT	Logged data
16		Sub-region number	Get only	0 to 99	0	AN	Logged data
17	Sub-region number (X)	Get only	0 to 9	0	ANX	Logged data	

External reference number	Category	Data name	Set / Get	Data range	Default	Expression text string	Logged data/ Judgement parameter
18	Measurement result	Sub-region number (Y)	Get only	0 to 9	0	ANY	Logged data
19		Measurement position X (sub-region)	Get only	-99,999.9999 to 99,999.9999	0	DX	Logged data
20		Measurement position Y (sub-region)	Get only	-99,999.9999 to 99,999.9999	0	DY	Logged data
103	Output parameter	Reflect	Set / Get	0: Yes 1: No	0	---	---
121	Model region	Rotation	Set / Get	0: No rotation 1: Rotation	0	---	---
122		Rotation angle upper limit	Set / Get	-180 to 180	180	---	---
123		Rotation angle lower limit	Set / Get	-180 to 180	-180	---	---
132	Detection point coordinate	Detection point X	Set / Get	0 to 9999	0	---	---
133		Detection point Y	Set / Get	0 to 9999	0	---	---
134	Measurement conditions	Sub-pixel	Set / Get	0: No 1: Yes	0	---	---
135		Candidate level	Set / Get	0 to 100	70	---	---
136	Judgement conditions	Judgement upper limit for search coordinate X	Set / Get	-99,999.9999 to 99,999.9999	99,999.9999	---	Judgement condition
137		Judgement lower limit for search coordinate X	Set / Get	-99,999.9999 to 99,999.9999	-99,999.9999	---	Judgement condition
138		Judgement upper limit for search coordinate Y	Set / Get	-99,999.9999 to 99,999.9999	99,999.9999	---	Judgement condition
139		Judgement lower limit for search coordinate Y	Set / Get	-99,999.9999 to 99,999.9999	-99,999.9999	---	Judgement condition
140		Judgement upper limit for search angle	Set / Get	-180 to 180	180	---	Judgement condition
141		Judgement lower limit for search angle	Set / Get	-180 to 180	-180	---	Judgement condition
142	Judgement conditions	Judgement upper limit for correlation	Set / Get	0 to 100	100	---	Judgement condition
143		Judgement lower limit for correlation	Set / Get	0 to 100	60	---	Judgement condition
145		Density deviation upper limit	Set / Get	Color Cameras: 0 to 221 Monochrome Cameras: 0 to 127	Color Camera: 221 Monochrome Camera: 127	---	Judgement condition
146		Density deviation lower limit	Set / Get	Color Cameras: 0 to 221 Monochrome Cameras: 0 to 127	0	---	Judgement condition
147		NG sub-region upper limit	Set / Get	0 to 100	100	---	---
148		NG sub-region lower limit	Set / Get	0 to 100	0	---	---

External reference number	Category	Data name	Set / Get	Data range	Default	Expression text string	Logged data/Judgement parameter
153	Measurement conditions	Plain inspection	Set / Get	0: No 1: Yes	0	---	---
169		Gain setting	Set / Get	0: 3×3 sub-divisions 1: 5×5 sub-divisions 2: 9×9 sub-divisions	1	---	---
310	Logging conditions	Data logging switch for entire unit	Set / Get	0: Data logging OFF 1: Data logging ON	1	---	---
311		Data logging switch for judgement	Set / Get	0: Data logging OFF 1: Data logging ON	1	---	---
312		Data logging switch for correlation	Set / Get	0: Data logging OFF 1: Data logging ON	1	---	---
313		Data logging switch for density deviation	Set / Get	0: Data logging OFF 1: Data logging ON	1	---	---
314		Data logging switch for position X	Set / Get	0: Data logging OFF 1: Data logging ON	1	---	---
315		Data logging switch for position Y	Set / Get	0: Data logging OFF 1: Data logging ON	1	---	---
316		Data logging switch for measurement angle	Set / Get	0: Data logging OFF 1: Data logging ON	1	---	---
320		Data logging switch for NG sub-region	Set / Get	0: Data logging OFF 1: Data logging ON	1	---	---
321		Data logging switch for sub-region correlation	Set / Get	0: Data logging OFF 1: Data logging ON	1	---	---
322		Data logging switch for sub-region density deviation	Set / Get	0: Data logging OFF 1: Data logging ON	1	---	---
323		Data logging switch for sub-region number	Set / Get	0: Data logging OFF 1: Data logging ON	1	---	---
324	Data logging switch for sub-region number (X)	Set / Get	0: Data logging OFF 1: Data logging ON	1	---	---	
325	Data logging switch for sub-region number (Y)	Set / Get	0: Data logging OFF 1: Data logging ON	1	---	---	
326	Logging conditions	Data logging switch for measurement position X (sub-region)	Set / Get	0: Data logging OFF 1: Data logging ON	1	---	---
327		Data logging switch for measurement position Y (sub-region)	Set / Get	0: Data logging OFF 1: Data logging ON	1	---	---
700	Display settings	Correlation display	Set / Get	0: Display 1: Do not display	0	---	---
701		Position X display	Set / Get	0: Display 1: Do not display	0	---	---
702		Position Y display	Set / Get	0: Display 1: Do not display	0	---	---
703		Measurement angle display	Set / Get	0: Display 1: Do not display	0	---	---
704		Density deviation display	Set / Get	0: Display 1: Do not display	0	---	---

External reference number	Category	Data name	Set / Get	Data range	Default	Expression text string	Logged data/Judgement parameter
800	Measurement result display	Position X display pattern	Set / Get	0: Absolute value 1: Relative value	0	---	---
801		Position Y display pattern	Set / Get	0: Absolute value 1: Relative value	0	---	---
802		Measured angle display pattern	Set / Get	0: Absolute value 1: Relative value	0	---	---
1000+N (N=0 to 99)	Measurement result	Sub-region correlation N	Get only	0 to 100	0	CRN	---
1100+N (N=0 to 99)		Sub-region density deviation N	Get only	Sub-region density deviation N	0	DVN	---

Shape Search II (FQ2-S1/S2/S3 series or FQ2-S4 series only)

External reference number	Category	Data name	Set / Get	Data range	Default	Expression text string	Logged data/Judgement parameter
0	Measurement result	Judgement	Get only	-2: No judgement (not measured), 0: Judgement is OK, -1: Judgement is NG, -13: Teaching not performed error, -14: Figure not registered error, -15: Out of range error	-2	JG	Logged data
5		Correlation	Get only	0 to 100	0	CR[0] to CR[31]	Logged data
6		Position X	Get only	-99,999.9999 to 99,999.9999	0	X[0] to X[31]	Logged data
7		Position Y	Get only	-99,999.9999 to 99,999.9999	0	Y[0] to Y[31]	Logged data
8		Angle	Get only	-180 to 180	0	TH[0] to TH[31]	Logged data
9	Measurement result	Reference X	Get only	-99,999.9999 to 99,999.9999	0	SX	---
10		Reference Y	Get only	-99,999.9999 to 99,999.9999	0	SY	---
11		Reference angle	Get only	-180 to 180	0	ST	---
12		Detection coordinate X	Get only	-99,999.9999 to 99,999.9999	0	RX	---
13		Detection coordinate Y	Get only	-99,999.9999 to 99,999.9999	0	RY	---
14		Count	Get only	0 to 32	0	C	Logged data
103	Output parameter	Reflect	Set / Get	0: Yes 1: No	0	---	---
120	Model region	Rotation	Set / Get	0: Yes 1: No	0	---	---
121		Rotation angle upper limit	Set / Get	-180 to 180	180	---	---
122		Rotation angle lower limit	Set / Get	-180 to 180	-180	---	---

External reference number	Category	Data name	Set / Get	Data range	Default	Expression text string	Logged data/Judgement parameter
133	Measurement conditions	Candidate level	Set / Get	0 to 100	80	---	---
134	Detection point coordinate	Detection point X	Set / Get	0 to 9999	0	---	---
135		Detection point Y	Set / Get	0 to 9999	0	---	---
136	Measurement condition	Sort condition	Set / Get	0: Ascending order of correlation value, 1: Descending order of correlation value, 2: Ascending order of position X, 3: Descending order of position X, 4: Ascending order of position Y, 5: Descending order of position Y	1	---	---
138	Judgement conditions	Judgement upper limit for correlation	Set / Get	0 to 100	100	---	Judgement condition
139		Judgement lower limit for correlation	Set / Get	0 to 100	60	---	Judgement condition
140		Judgement upper limit for detection count	Set / Get	0 to 32	32	---	Judgement condition
141		Judgement lower limit for detection count	Set / Get	0 to 32	0	---	Judgement condition
142		Judgement upper limit for search coordinate X	Set / Get	-99,999.9999 to 99,999.9999	99,999.9999	---	Judgement condition
143		Judgement lower limit for search coordinate X	Set / Get	-99,999.9999 to 99,999.9999	-99,999.9999	---	Judgement condition
144		Judgement upper limit for search coordinate Y	Set / Get	-99,999.9999 to 99,999.9999	99,999.9999	---	Judgement condition
145		Judgement lower limit for search coordinate Y	Set / Get	-99,999.9999 to 99,999.9999	-99,999.9999	---	Judgement condition
146	Judgement conditions	Judgement upper limit for search angle	Set / Get	-180 to 180	180	---	Judgement condition
147		Judgement lower limit for search angle	Set / Get	-180 to 180	-180	---	Judgement condition
152	Measurement conditions	Extraction condition, X upper limit	Set / Get	-99,999.9999 to 99,999.9999	99,999.9999	---	Judgement condition
153		Extraction condition, X lower limit	Set / Get	-99,999.9999 to 99,999.9999	-99,999.9999	---	Judgement condition
154		Extraction condition, Y upper limit	Set / Get	-99,999.9999 to 99,999.9999	99,999.9999	---	Judgement condition
155		Extraction condition, Y lower limit	Set / Get	-99,999.9999 to 99,999.9999	-99,999.9999	---	Judgement condition
161		Detection count	Set / Get	1 to 32	32	---	---
170		Model mode	Set / Get	0: Fast 1: Stable	0	---	---
300	Logging conditions	Number of data log records upper limit	Set / Get	1 to 32	32	---	---
310		Data logging switch for entire unit	Set / Get	0: Data logging OFF 1: Data logging ON	1	---	---
311		Data logging switch for judgement	Set / Get	0: Data logging OFF 1: Data logging ON	1	---	---

External reference number	Category	Data name	Set / Get	Data range	Default	Expression text string	Logged data/Judgement parameter
312	Logging conditions	Data logging switch for correlation	Set / Get	0: Data logging OFF 1: Data logging ON	1	---	---
313		Data logging switch for position X	Set / Get	0: Data logging OFF 1: Data logging ON	1	---	---
314		Data logging switch for position Y	Set / Get	0: Data logging OFF 1: Data logging ON	1	---	---
315		Data logging switch for measurement angle	Set / Get	0: Data logging OFF 1: Data logging ON	1	---	---
321		Data logging switch for detection count	Set / Get	0: Data logging OFF 1: Data logging ON	1	---	---
700	Display settings	Correlation display	Set / Get	0: Display 1: Do not display	0	---	---
701		Position X display	Set / Get	0: Display 1: Do not display	0	---	---
702		Position Y display	Set / Get	0: Display 1: Do not display	0	---	---
703		Measurement angle display	Set / Get	0: Display 1: Do not display	0	---	---
704		Count display	Set / Get	0: Display 1: Do not display	0	---	---
800		Position X display pattern	Set / Get	0: Absolute value 1: Relative value	0	---	---
801		Position Y display pattern	Set / Get	0: Absolute value 1: Relative value	0	---	---
802	Measurement angle display pattern	Set / Get	0: Absolute value 1: Relative value	0	---	---	

Shape Search III (FQ2-S1/S2/S3 series or FQ2-S4 series only)

External reference number	Category	Data name	Set / Get	Data range	Default	Expression text string	Logged data/Judgement parameter
0	Measurement result	Judgement	Get only	-2: No judgement (not measured) 0: Judgement is OK -1: Judgement is NG -13: Teaching not performed error -14: Figure not registered error -15: Out of range error	-2	JG	Logged data
5		Correlation	Get only	0 to 100	0	CR[0] to CR[31]	Logged data
6		Position X	Get only	-99,999.9999 to 99,999.9999	0	X[0] to X[31]	Logged data
7		Position Y	Get only	-99,999.9999 to 99,999.9999	0	Y[0] to Y[31]	Logged data
8		Angle	Get only	-180 to 180	0	TH[0] to TH[31]	Logged data

External reference number	Category	Data name	Set / Get	Data range	Default	Expression text string	Logged data/Judgement parameter
9	Measurement result	Reference X	Get only	-99,999.9999 to 99,999.9999	0	SX	---
10		Reference Y	Get only	-99,999.9999 to 99,999.9999	0	SY	---
11		Reference angle	Get only	-180 to 180	0	ST	---
12		Detection coordinate X	Get only	-99,999.9999 to 99,999.9999	0	RX	---
13		Detection coordinate Y	Get only	-99,999.9999 to 99,999.9999	0	RY	---
14		Count	Get only	0 to 32	0	C	Logged data
103	Output parameter	Reflect	Set / Get	0: Yes 1: No	0	---	---
120	Model region	Rotation	Set / Get	0: No 1: Yes	0	---	---
121		Rotation angle upper limit	Set / Get	-180 to 180	180	---	---
122		Rotation angle lower limit	Set / Get	-180 to 180	-180	---	---
123	Measurement conditions	Edge level (model)	Set / Get	0 to 1024	20	---	---
133		Candidate level	Set / Get	0 to 100	50	---	---
134	Detection point coordinate	Detection point X	Set / Get	0 to 9999	0	---	---
135		Detection point Y	Set / Get	0 to 9999	0	---	---
136	Measurement condition	Sort condition	Set / Get	0: Ascending order of correlation value, 1: Descending order of correlation value, 2: Ascending order of position X, 3: Descending order of position X, 4: Ascending order of position Y, 5: Descending order of position Y	1	---	---
138	Judgement conditions	Judgement upper limit for correlation	Set / Get	0 to 100	100	---	Judgement condition
139		Judgement lower limit for correlation	Set / Get	0 to 100	60	---	Judgement condition
140		Judgement upper limit for detection count	Set / Get	0 to 32	32	---	Judgement condition
141		Judgement lower limit for detection count	Set / Get	0 to 32	0	---	Judgement condition
142		Judgement upper limit for search coordinate X	Set / Get	-99,999.9999 to 99,999.9999	99,999.9999	---	Judgement condition
143		Judgement lower limit for search coordinate X	Set / Get	-99,999.9999 to 99,999.9999	-99,999.9999	---	Judgement condition
144		Judgement upper limit for search coordinate Y	Set / Get	-99,999.9999 to 99,999.9999	99,999.9999	---	Judgement condition
145		Judgement lower limit for search coordinate Y	Set / Get	-99,999.9999 to 99,999.9999	-99,999.9999	---	Judgement condition
146	Judgement conditions	Judgement upper limit for search angle	Set / Get	-180 to 180	180	---	Judgement condition
147		Judgement lower limit for search angle	Set / Get	-180 to 180	-180	---	Judgement condition

External reference number	Category	Data name	Set / Get	Data range	Default	Expression text string	Logged data/ Judgement parameter
150	Measurement conditions	Edge level (measurement)	Set / Get	0 to 1024	30	---	---
152		Extraction condition, X upper limit	Set / Get	-99,999.9999 to 99,999.9999	99,999.9999	---	Judgement condition
153		Extraction condition, X lower limit	Set / Get	-99,999.9999 to 99,999.9999	-99,999.9999	---	Judgement condition
154		Extraction condition, Y upper limit	Set / Get	-99,999.9999 to 99,999.9999	99,999.9999	---	Judgement condition
155		Extraction condition, Y lower limit	Set / Get	-99,999.9999 to 99,999.9999	-99,999.9999	---	Judgement condition
160		Image type	Set / Get	0: Measurement image 1: Measurement image + Model image 2: Edge image 3: Edge image + Model image	1	---	
161		Detection count	Set / Get	1 to 32	32	---	---
172		Edge level auto (measurement)	Set / Get	0: OFF 1: ON	1	---	---
174		Mask size	Set / Get	0: 3 x 3 1: 5 x 5 2: 7 x 7	0	---	---
178		Edge level auto (model)	Set / Get	0: OFF 1: ON	1	---	---
180		Acceptable distortion level	Set / Get	0: Low 1: Middle 2: High	2	---	---
181		Noise Removal Level	Set / Get	0 to 100	0	---	---
188		Model mode	Set / Get	0: Stable 1: Fast	0	---	---
229		Overlay judgement	Set / Get	0: No 1: Yes	0	---	---
230	Overlay rejection	Set / Get	0 to 100	100	---	---	
300	Logging conditions	Number of data log records upper limit	Set / Get	1 to 32	32	---	---
310		Data logging switch for entire unit	Set / Get	0: Data logging OFF 1: Data logging ON	1	---	---
311		Data logging switch for judgement	Set / Get	0: Data logging OFF 1: Data logging ON	1	---	---
312		Data logging switch for correlation	Set / Get	0: Data logging OFF 1: Data logging ON	1	---	---
313		Data logging switch for position X	Set / Get	0: Data logging OFF 1: Data logging ON	1	---	---
314		Data logging switch for position Y	Set / Get	0: Data logging OFF 1: Data logging ON	1	---	---
315		Data logging switch for measurement angle	Set / Get	0: Data logging OFF 1: Data logging ON	1	---	---
321		Data logging switch for detection count	Set / Get	0: Data logging OFF 1: Data logging ON	1	---	---

External reference number	Category	Data name	Set / Get	Data range	Default	Expression text string	Logged data/Judgement parameter
700	Display settings	Correlation display	Set / Get	0: Display 1: Do not display	0	---	---
701		Position X display	Set / Get	0: Display 1: Do not display	0	---	---
702		Position Y display	Set / Get	0: Display 1: Do not display	0	---	---
703		Measurement angle display	Set / Get	0: Display 1: Do not display	0	---	---
704		Count display	Set / Get	0: Display 1: Do not display	0	---	---
800		Position X display pattern	Set / Get	0: Absolute value 1: Relative value	0	---	---
801		Position Y display pattern	Set / Get	0: Absolute value 1: Relative value	0	---	---
802		Measurement angle display pattern	Set / Get	0: Absolute value 1: Relative value	0	---	---

Edge Position (FQ2-S1/S2/S3 series or FQ2-S4 series only)

External reference number	Category	Data name	Set / Get	Data range	Default	Expression text string	Logged data/Judgement parameter
0	Measurement result	Judgement	Get only	-2: No judgement (not measured) 0: Judgement is OK -1: Judgement is NG -13: Teaching not performed error -14: Figure not registered error -15: Out of range error	-2	JG	Logged data
5		Edge position X	Get only	-99,999.9999 to 99,999.9999	0	X	Logged data
6		Edge position Y	Get only	-99,999.9999 to 99,999.9999	0	Y	Logged data
7		Standard position X	Get only	-99,999.9999 to 99,999.9999	0	SX	---
8		Standard position Y	Get only	-99,999.9999 to 99,999.9999	0	SY	---
9		Difference in position	Get only	-99,999.9999 to 99,999.9999	0	DF	Logged data
103	Output parameter	Reflect	Set / Get	0: Yes, 1: No	0	---	---
120	Set color	Set color	Set / Get	0: No edge color specification, 1: Edge color specification	0	---	---
121		Edge color red	Set / Get	0 to 255	255	---	---
122		Edge color green	Set / Get	0 to 255	255	---	---
123		Edge color blue	Set / Get	0 to 255	255	---	---
132	Measurement conditions	Edge level	Set / Get	0 to 100	50	---	---
133		Noise level	Set / Get	0 to 442	5	---	---

External reference number	Category	Data name	Set / Get	Data range	Default	Expression text string	Logged data/Judgement parameter
136	Judgement conditions	Edge position X upper limit	Set / Get	-99,999.9999 to 99,999.9999	99,999.9999	---	Judgement condition
137		Edge position X lower limit	Set / Get	-99,999.9999 to 99,999.9999	-99,999.9999	---	Judgement condition
138		Edge position Y upper limit	Set / Get	-99,999.9999 to 99,999.9999	99,999.9999	---	Judgement condition
139		Edge position Y lower limit	Set / Get	-99,999.9999 to 99,999.9999	-99,999.9999	---	Judgement condition
140	Measurement condition	Detection mode for Monochrome Sensor	Set / Get	0: Light to Dark 1: Dark to Light	0	---	---
141		Edge level absolute value	Set / Get	0 to 442	20	---	---
142		Edge level specification method	Set / Get	0:% 1:Absolute value	0	---	---
144		Measurement method	Set / Get	0: Projection 1: Differentiation	0	---	---
145	Judgement conditions	Edge position offset upper limit	Set / Get	-99,999.9999 to 99,999.9999	99,999.9999	---	Judgement condition
146		Edge position offset lower limit	Set / Get	-99,999.9999 to 99,999.9999	-99,999.9999	---	Judgement condition
147	Measurement condition	Edge level absolute value (Monochrome Cameras)	Set / Get	0 to 255	20	---	---
310	Logging conditions	Data logging switch for entire unit	Set / Get	0: Data logging OFF 1: Data logging ON	1	---	---
311		Data logging switch for judgement	Set / Get	0: Data logging OFF 1: Data logging ON	1	---	---
312		Data logging switch for detected edge position X	Set / Get	0: Data logging OFF 1: Data logging ON	1	---	---
313		Data logging switch for detected edge position Y	Set / Get	0: Data logging OFF 1: Data logging ON	1	---	---
316		Data logging switch for scroll	Set / Get	0: Data logging OFF 1: Data logging ON	0	---	---
700	Display settings	Edge position offset display	Set / Get	0: Display 1: Do not display	1	---	---
701		Detected edge position X display	Set / Get	0: Display 1: Do not display	0	---	---
702		Detected edge position Y display	Set / Get	0: Display 1: Do not display	0	---	---
800		Detected edge position X display pattern	Set / Get	0: Absolute value 1: Relative value	0	---	---
801		Detected edge position Y display pattern	Set / Get	0: Absolute value 1: Relative value	0	---	---

Edge Width (FQ2-S1/S2/S3 series or FQ2-S4 series only)

External reference number	Category	Data name	Set / Get	Data range	Default	Expression text string	Logged data/Judgement parameter
0	Measurement result	Judgement	Get only	-2: No judgement (not measured), 0: Judgement is OK -1: Judgement is NG -13: Teaching not performed error -14: Figure not registered error -15: Out of range error	-2	JG	---
5		Edge width	Get only	0 to 99,999.9999	0	W	Logged data
6		Reference edge width	Get only	0 to 99,999.9999	0	SW	Logged data
7		Difference in edge width	Get only	0 to 99,999.9999	0	DF	Logged data
103	Output parameter	Reflect	Set / Get	0: Yes 1: No	0	---	---
120	Measurement conditions	Edge level specification method	Set / Get	0:% 1: Absolute value	0	---	---
121	Set color	Set color	Set / Get	Edge color specification 0: Not specified, 1: Specified	0	---	---
122	Measurement conditions	Measurement method	Set / Get	0: Projection 1: Differentiation	0	---	---
131		Edge color red	Set / Get	0 to 255	255	---	---
132		Edge color green	Set / Get	0 to 255	255	---	---
133		Edge color blue	Set / Get	0 to 255	255	---	---
137		Edge level	Set / Get	0 to 100	50	---	---
138		Edge level absolute value	Set / Get	0 to 442	20	---	---
139		Noise level	Set / Get	5 to 442	5	---	---
142		Density change	Set / Get	0: Light to Dark 1: Dark to Light	0	---	---
143		Edge level absolute value (Monochrome Cameras)	Set / Get	0 to 255	20	---	---
190	Judgement conditions	Edge width upper limit	Set / Get	-99,999.9999 to 99,999.9999	99,999.9999	---	Judgement condition
191		Edge width lower limit	Set / Get	-99,999.9999 to 99,999.9999	0	---	
310	Logging conditions	Data logging switch for entire unit	Set / Get	0: Data logging OFF 1: Data logging ON	1	---	---
311		Data logging switch for judgement	Set / Get	0: Data logging OFF 1: Data logging ON	1	---	---
312		Data logging switch for edge width	Set / Get	0: Data logging OFF 1: Data logging ON	1	---	---
700	Display settings	Edge width display	Setting/ Acquisition	0: Display 1: Do not display	0	---	---
800		Wedge width display pattern	Setting/ Acquisition	0: Absolute value 1: Relative value 2: Percentage	0	---	---

Edge Pitch (FQ2-S1/S2/S3 series or FQ2-S4 series only)

External reference number	Category	Data name	Set / Get	Data range	Default	Expression text string	Logged data/Judgement parameter
0	Measurement result	Judgement	Get only	-2: No judgement (not measured), 0: Judgement is OK, -1: Judgement is NG -13: Teaching not performed error, -14: Figure not registered error, -15: Out of range error	-2	JG	Logged data
5		Edge pitch	Get only	0 to 999	0	N	Logged data
6		Average pitch	Get only	0 to 99,999.9999	0	P	Logged data
7		Maximum pitch	Get only	0 to 99,999.9999	0	PH	Logged data
8		Minimum pitch	Get only	0 to 99,999.9999	0	PL	Logged data
9		Average width	Get only	0 to 99,999.9999	0	W	Logged data
10		Maximum pitch	Get only	0 to 99,999.9999	0	WH	Logged data
11		Minimum pitch	Get only	0 to 99,999.9999	0	WL	Logged data
103	Output parameter	Reflect	Set / Get	0: Yes 1: No	0	---	---
120	Measurement conditions	Edge color red	Set / Get	0 to 255	255	---	---
121		Edge color green	Set / Get	0 to 255	255	---	---
122		Edge color blue	Set / Get	0 to 255	255	---	---
127		Edge level	Set / Get	0 to 100	50	---	---
128		Noise level	Set / Get	0 to 442	5	---	---
130	Judgement conditions	Edge pitch upper limit	Set / Get	0 to 1,000	1,000	---	Judgement condition
131		Edge pitch lower limit	Set / Get	0 to 1,000	0	---	Judgement condition
132		Average pitch upper limit	Set / Get	0 to 99,999.9999	99,999.9999	---	Judgement condition
133		Average pitch lower limit	Set / Get	0 to 99,999.9999	0	---	Judgement condition
134		Pitch upper limit	Set / Get	0 to 99,999.9999	99,999.9999	---	Judgement condition
135		Pitch lower limit	Set / Get	0 to 99,999.9999	0	---	Judgement condition
136		Average width upper limit	Set / Get	0 to 99,999.9999	99,999.9999	---	Judgement condition
137		Average width lower limit	Set / Get	0 to 99,999.9999	0	---	Judgement condition
138		Width upper limit	Set / Get	0 to 99,999.9999	99,999.9999	---	Judgement condition
139		Width lower limit	Set / Get	0 to 99,999.9999	0	---	Judgement condition

External reference number	Category	Data name	Set / Get	Data range	Default	Expression text string	Logged data/Judgement parameter
140	Measurement conditions	Edge enhancement level	Set / Get	0 to 442	100	---	---
141		Color to count	Set / Get	(Monochrome Cameras) 0: White 1: Black	0	---	---
142		Mode	Set / Get	(Monochrome Cameras) 0: Standard 1: Precise	0	---	---
310	Logging conditions	Data logging switch for entire unit	Set / Get	0: Data logging OFF 1: Data logging ON	1	---	---
311		Data logging switch for judgement	Set / Get	0: Data logging OFF 1: Data logging ON	1	---	---
312		Data logging switch for edge pitch	Set / Get	0: Data logging OFF 1: Data logging ON	1	---	---
313		Data logging switch for average pitch	Set / Get	0: Data logging OFF 1: Data logging ON	1	---	---
314		Data logging switch for maximum pitch	Set / Get	0: Data logging OFF 1: Data logging ON	1	---	---
315		Data logging switch for minimum pitch	Set / Get	0: Data logging OFF 1: Data logging ON	1	---	---
316		Data logging switch for average width	Set / Get	0: Data logging OFF 1: Data logging ON	1	---	---
317		Data logging switch for maximum width	Set / Get	0: Data logging OFF 1: Data logging ON	1	---	---
318		Data logging switch for minimum width	Set / Get	0: Data logging OFF 1: Data logging ON	1	---	---
700	Display settings	Edge pitch display	Set / Get	0: Display 1: Do not display	0	---	---
701		Average pitch display	Set / Get	0: Display 1: Do not display	0	---	---
702		Pitch display	Set / Get	0: Display 1: Do not display	0	---	---
703		Average width display	Set / Get	0: Display 1: Do not display	0	---	---
704		Width display	Set / Get	0: Display 1: Do not display	0	---	---

Area (FQ2-S1/S2/S3 series or FQ2-S4 series only)

External reference number	Category	Data name	Set / Get	Data range	Default	Expression text string	Logged data/Judgement parameter
0	Measurement result	Judgement	Get only	-2: No judgement (not measured), 0: Judgement is OK, -1: Judgement is NG, -13: Teaching not performed error, -14: Figure not registered error, -15: Out of range error	-2	JG	---
5	Measurement result	Area	Get only	0 to 999,999,999.9999	0	AR	---
6		Gravity X	Get only	-99,999.9999 to 99,999.9999	0	X	Logged data
7		Gravity Y	Get only	-99,999.9999 to 99,999.9999	0	Y	Logged data
8		Reference area	Get only	0 to 999,999,999	0	SA	Logged data
9		Reference position X	Get only	-99,999.9999 to 99,999.9999	0	SX	---
10		Reference position Y	Get only	-99,999.9999 to 99,999.9999	0	SY	---
11		Area deviation	Get only	-999,999,999.9999 to 999,999,999.9999	0	DF	Logged data
103	Output parameter	Reflect	Set / Get	0: Yes 1: No	0	---	---
127	Measurement conditions	Background color	Set / Get	0: Black 1: White 2: Red 3: Green 4: Blue	0	---	---
128		Fill profile	Set / Get	0: No 1: Fill outline, 2: Filling up holes	0	---	---
129		Area color inversion	Set / Get	0: None 1: Enabled The binary inversion is displayed for a Monochrome Camera.	0	---	---
135	Judgement	Judgement upper limit for area	Set / Get	0 to 999,999,999.9999	999,999,999.9999	---	---
136		Judgement lower limit for area	Set / Get	0 to 999,999,999.9999	0	---	---
137		Judgement upper limit for gravity X	Set / Get	-99,999.9999 to 99,999.9999	99,999.9999	---	---
138		Judgement lower limit for gravity X	Set / Get	-99,999.9999 to 99,999.9999	-99,999.9999	---	---
139		Judgement upper limit for gravity Y	Set / Get	-99,999.9999 to 99,999.9999	99,999.9999	---	---
140		Judgement lower limit for gravity Y	Set / Get	-99,999.9999 to 99,999.9999	-99,999.9999	---	---
141		Judgement upper limit for binary threshold	Set / Get	0 to 255	255	---	---
142		Judgement lower limit for binary threshold	Set / Get	0 to 255	128	---	---

External reference number	Category	Data name	Set / Get	Data range	Default	Expression text string	Logged data/Judgement parameter
143	Measurement conditions	Binary image display	Set / Get	(Monochrome Cameras) 0: No binary image display, 1: Binary image display	1	---	---
144		Image type	Set / Get	0: Measurement image, 1: Color extraction image, 2: Selected color image, 3: Binary image after extraction	1	---	---
145		Enable/disable multiple selection	Set / Get	0: Enabled, 1: Disabled	1	---	---
160+N×10 (N=0 to 3)	Set color	Registered color usage flag N	Set / Get	0: Not used 1: Used	1(N=0), 0(N=1 to 3)	---	---
161+N×10 (N=0 to 3)		Registered color OR/NOT flag N	Set / Get	0: OR, 1: NOT	0	---	---
162+N×10 (N=0 to 3)		Registered color maximum hue N	Set / Get	0 to 359	359	---	---
163+N×10 (N=0 to 3)		Registered color minimum hue N	Set / Get	0 to 359	0	---	---
164+N×10 (N=0 to 3)		Registered color maximum saturation N	Set / Get	0 to 255	255	---	---
165+N×10 (N=0 to 3)		Registered color minimum saturation N	Set / Get	0 to 255	0	---	---
166+N×10 (N=0 to 3)		Registered color maximum brightness N	Set / Get	0 to 255	255	---	---
167+N×10 (N=0 to 3)		Registered color minimum brightness N	Set / Get	0 to 255	0	---	---
310	Logging conditions	Data logging switch for entire unit	Set / Get	0: Data logging OFF 1: Data logging ON	1	---	---
311		Data logging switch for judgement	Set / Get	0: Data logging OFF 1: Data logging ON	1	---	---
312		Data logging switch for area	Set / Get	0: Data logging OFF 1: Data logging ON	1	---	---
313		Data logging switch for gravity X	Set / Get	0: Data logging OFF 1: Data logging ON	1	---	---
314		Data logging switch for gravity Y	Set / Get	0: Data logging OFF 1: Data logging ON	1	---	---
700	Display settings	Area display	Set / Get	0: Display area 1: Do not display area	0	---	---
701		Gravity X display	Set / Get	0: Display gravity X 1: Do not display gravity X	0	---	---
702		Gravity Y display	Set / Get	0: Display gravity Y 1: Do not display gravity Y	0	---	---
800		Area display pattern	Set / Get	0: Absolute value 1: Relative value 2: Percentage	0	---	---
801		Gravity X display pattern	Set / Get	0: Absolute value 1: Relative value	0	---	---
802		Gravity Y display pattern	Set / Get	0: Absolute value 1: Relative value	0	---	---

Color Data (FQ2-S1/S2/S3 series or FQ2-S4 series only)

External reference number	Category	Data name	Set / Get	Data range	Default	Expression text string	Logged data/Judgement parameter
0	Measurement result	Judgement	Get only	-2: No judgement (not measured), 0: Judgement is OK, -1: Judgement is NG, -10: Image error, -13: Teaching not performed error, -14: Figure not registered error, -15: Out of range error, -20: Other error	-2	JG	---
5		R average	Get only	0 to 255	0	AR	---
6		G average	Get only	0 to 255	0	AG	---
7		B average	Get only	0 to 255	0	AB	---
8		Color difference	Get only	0 to 442 The density average is displayed for a Monochrome Camera.	0	AD	Logged data
9		Color deviation	Get only	0 to 221 The standard deviation of the density is displayed for a Monochrome Camera.	0	DV	---
103	Output parameter	Reflect	Set / Get	0: Yes, 1: No	0	---	---
124	Judgement conditions	Color difference upper limit	Set / Get	0 to 442	442	---	Judgement condition
125		Color difference lower limit	Set / Get	0 to 442	0		
126	Measurement conditions	Color deviation upper limit	Set / Get	0 to 221	221	---	---
127		Color deviation lower limit	Set / Get	0 to 221	0	---	---
130		Density average upper limit	Set / Get	0 to 255	255	---	---
131		Density average lower limit	Set / Get	0 to 255	0	---	---
132		Density deviation upper limit	Set / Get	0 to 127	127	---	---
133		Density deviation lower limit	Set / Get	0 to 127	0	---	---
134		R average upper limit	Set / Get	0 to 255	255	---	---
135		R average lower limit	Set / Get	0 to 255	0	---	---
136		G average upper limit	Set / Get	0 to 255	255	---	---
137		G average lower limit	Set / Get	0 to 255	0	---	---
138	Measurement conditions	B average upper limit	Set / Get	0 to 255	255	---	---
139		B average lower limit	Set / Get	0 to 255	0	---	---

External reference number	Category	Data name	Set / Get	Data range	Default	Expression text string	Logged data/Judgement parameter
310	Logging conditions	Data logging switch for entire unit	Set / Get	0: Data logging OFF 1: Data logging ON	1	---	---
311		Data logging switch for judgement	Set / Get	0: Data logging OFF 1: Data logging ON	1	---	---
312		Data logging switch for average deviation/density average	Set / Get	0: Data logging OFF 1: Data logging ON	1	---	---
313		Data logging switch for color deviation/density deviation	Set / Get	0: Data logging OFF 1: Data logging ON	1	---	---
314		Data logging switch for R average	Set / Get	0: Data logging OFF 1: Data logging ON	1	---	---
315		Data logging switch for G average	Set / Get	0: Data logging OFF 1: Data logging ON	1	---	---
316		Data logging switch for B average	Set / Get	0: Data logging OFF 1: Data logging ON	1	---	---
317		Data logging switch for reference average	Set / Get	0: Data logging OFF 1: Data logging ON	1	---	---
318		Data logging switch for standard deviation	Set / Get	0: Data logging OFF 1: Data logging ON	1	---	---
319		Data logging switch for density average difference	Set / Get	0: Data logging OFF 1: Data logging ON	1	---	---
320		Data logging switch for density deviation difference	Set / Get	0: Data logging OFF 1: Data logging ON	1	---	---
700		Display settings	Average color display	Set / Get	0: Display 1: Do not display	0	---
701	Color deviation display		Set / Get	0: Display 1: Do not display	0	---	---
702	R average display		Set / Get	0: Display 1: Do not display	1	---	---
703	G average display		Set / Get	0: Display 1: Do not display	1	---	---
704	B average display		Set / Get	0: Display 1: Do not display	1	---	---
705	Density average display		Set / Get	0: Display 1: Do not display	0	---	---
706	Density deviation display		Set / Get	0: Display 1: Do not display	0	---	---

Labeling (FQ2-S1/S2/S3 series or FQ2-S4 series only)

External reference number	Category	Data name	Set / Get	Data range	Default	Expression text string	Logged data/Judgement parameter
0	Measurement result	Judgement	Get only	-2: No judgement (not measured), 0: Judgement is OK, -1: Judgement is NG, -13: Teaching not performed error, -14: Figure not registered error, -15: Out of range error	-2	JG	Logged data
5		Number of labels	Get only	0 to 100	0	L	Logged data
6		Area	Get only	0 to 999,999,999.9999	0	AR[0] to AR[99]	Logged data
7		Gravity center X	Get only	-99,999.9999 to 99,999.9999	0	X[0] to X[99]	Logged data
8		Gravity center Y	Get only	-99,999.9999 to 99,999.9999	0	Y[0] to Y[99]	Logged data
9		Reference area	Get only	0 to 999,999,999.9999	0	SA	---
10		Reference position X	Get only	-99,999.9999 to 99,999.9999	0	SX	---
11		Reference position Y	Get only	-99,999.9999 to 99,999.9999	0	SY	---
15		Total label area	Get only	0 to 999,999,999.9999	0	TAR	Logged data
55		Master angle	Get only	-180 to 180	0	ATH[0] to ATH[99]	Logged data
103	Output parameter	Reflect	Set / Get	0: Yes 1: No	0	---	---
127	Extracted image display condition	Background color	Set / Get	0: Black 1: White 2: Red 3: Green 4: Blue	0	---	---
131	Set color	Area color inversion	Set / Get	0: None 1: Enabled The binary value is displayed for a Monochrome Camera.	0	---	---
	Binary		Set / Get				
132	Measurement conditions	Filling up holes	Set / Get	0: No 1: Yes	0	---	---
133		Outside trimming	Set / Get	0: No 1: Yes	0	---	---
136		Label sort condition	Set / Get	0: Ascending order of area, 1: Descending order of area, 2: Ascending order of gravity X, 3: Descending order of gravity X, 4: Ascending order of gravity Y, 5: Descending order of gravity Y	1	---	---
146	Binary level	Binary level upper limit	Set / Get	0 to 255	255	---	---
147		Binary level lower limit	Set / Get	0 to 255	128	---	---
148	Extracted image display condition	Binary image display	Set / Get	0: No binary image display, 1: Binary image display	1	---	---
149		Image type	Set / Get	0: Measurement image, 1: Color extraction image, 2: Selected color image 3: Binary image after extraction	1	---	---

External reference number	Category	Data name	Set / Get	Data range	Default	Expression text string	Logged data/Judgement parameter
152	Measurement conditions	External reference label number	Set / Get	0 to 99	0	---	---
156		Extraction condition, detection count	Set / Get	1 to 100	100	---	---
160+N×10 (N=0 to 3)	Set color	Registered color usage flag N	Set / Get	0: Not used 1: Used	1	---	---
161+N×10 (N=0 to 3)		Registered color exclusion flag N	Set / Get	0: OR 1: NOT	0	---	---
162+N×10 (N=0 to 3)		Registered color maximum hue N	Set / Get	0 to 359	359	---	---
163+N×10 (N=0 to 3)		Registered color minimum hue N	Set / Get	0 to 359	0	---	---
164+N×10 (N=0 to 3)		Registered color maximum saturation N	Set / Get	0 to 255	255	---	---
165+N×10 (N=0 to 3)		Registered color minimum saturation N	Set / Get	0 to 255	0	---	---
166+N×10 (N=0 to 3)		Registered color maximum brightness N	Set / Get	0 to 255	255	---	---
167+N×10 (N=0 to 3)		Registered color minimum brightness N	Set / Get	0 to 255	0	---	---
300		Logging conditions	Number of data log records	Set / Get	1 to 100	100	---
310	Data logging switch for entire unit		Set / Get	0: Data logging OFF 1: Data logging ON	1	---	---
311	Data logging switch for judgement		Set / Get		1	---	---
312	Data logging switch for number of labels		Set / Get		1	---	---
313	Data logging switch for area		Set / Get		1	---	---
314	Data logging switch for gravity X		Set / Get		1	---	---
315	Data logging switch for gravity Y		Set / Get		1	---	---
317	Data logging switch for Reference average		Set / Get		0	---	---
319	Data logging switch for total label area		Set / Get		1	---	---
326	Data logging switch for master angle		Set / Get		1	---	---
503	Measurement condition	Extraction condition, Upper limit (Area)	Set / Get		0.0000 to 999,999,999.9999	999,999,999.9999	---
504		Extraction condition, Lower limit (Area)	Set / Get	0.0000 to 999,999,999.9999	0	---	---
513		Extraction condition, Upper limit (gravity X)	Set / Get	-999,999,999.9999 to 999,999,999.9999	999999999.9999	---	---
514		Extraction condition, Lower limit (gravity X)	Set / Get	-999,999,999.9999 to 999,999,999.9999	-999,999,999.9999	---	---
523		Extraction condition, Upper limit (gravity Y)	Set / Get	-999,999,999.9999 to 999,999,999.9999	999999999.9999	---	---
524		Extraction condition, Lower limit (gravity Y)	Set / Get	-999,999,999.9999 to 999,999,999.9999	999,999,999.9999	---	---

External reference number	Category	Data name	Set / Get	Data range	Default	Expression text string	Logged data/ Judgement parameter
602	Judgement	Judgement upper limit for number of labels	Set / Get	1 to 100	100	---	---
603		Judgement lower limit for number of labels	Set / Get	1 to 100	0	---	---
612		Judgement upper limit for label area	Set / Get	0 to 999,999,999.9999	999,999,999.9999	---	---
613		Judgement lower limit for label area	Set / Get	0 to 999,999,999.9999	0	---	---
622		Judgement upper limit for area	Set / Get	0 to 999,999,999.9999	999,999,999.9999	---	---
623		Judgement lower limit for area	Set / Get	0 to 999,999,999.9999	0	---	---
632		Judgement upper limit for gravity X	Set / Get	-99,999.9999 to 99,999.9999	99,999.9999	---	---
633		Judgement lower limit for gravity X	Set / Get	-99,999.9999 to 99,999.9999	-99,999.9999	---	---
642		Judgement upper limit for gravity Y	Set / Get	-99,999.9999 to 99,999.9999	99,999.9999	---	---
643		Judgement lower limit for gravity Y	Set / Get	-99,999.9999 to 99,999.9999	-99,999.9999	---	---
652		Judgement upper limit for master angle	Set / Get	-180 to 180	180	---	---
653		Judgement lower limit for master angle	Set / Get	-180 to 180	-180	---	---
700		Display settings	Number of labels display	Set / Get	0: ON 1: OFF	0	---
701	Total label area display		Set / Get	0: ON 1: OFF	0	---	---
702	Area display		Set / Get	0: ON 1: OFF	1	---	---
703	Gravity X display		Set / Get	0: ON 1: OFF	1	---	---
704	Gravity Y display		Set / Get	0: ON 1: OFF	1	---	---
705	Master angle display		Set / Get	0: ON 1: OFF	1	---	---

9-3 Specifications and Dimensions

FQ2-S1

FQ2-S2

FQ2-S3

FQ2-S4

FQ2-CH

Sensor

Specifications

FQ2-S1/S2/S3 Series

Item		Single-function models	Standard models	High-resolution models			
Model	NPN	FQ2-S10□□□□	FQ2-S20□□□□	FQ2-S30□□□□-08	FQ2-S30□□□□-08M	FQ2-S30-13	FQ2-S30-13M
	PNP	FQ2-S15□□□□	FQ2-S25□□□□	FQ2-S35□□□□-08	FQ2-S35□□□□-08M	FQ2-S35-13	FQ2-S35-13M
Field of view		Refer to Table 1.				Lens is select according to the field of vision and installation distance. Refer to the Optical Chart page.	
Installation distance		Refer to Table 1.					
Main functions	Inspection items	Search, shape search II, sensitive search, area, color data, edge position, edge pitch, edge width, and labeling					
	Number of simultaneous measurements	1	32				
	Position compensation	Supported (360° Model position compensation, Edge position compensation, Linear correction)					
	Number of registered scenes*1	8	32				
	Calibration	Supported					
Image input	Image processing method	Real color			Monochrome	Real color	Monochrome
	Image filter	High dynamic range (HDR), pre-processing (color gray filter (Sensors with Color Cameras only), weak smoothing, strong smoothing, dilate, erosion, median, extract edges, extract horizontal edges, extract vertical edges, enhance edges, and background suppression), polarizing filter (attachment), white balance (Sensors with Color Cameras only), and brightness correction					
	Image elements	1/3-inch color CMOS		1/2-inch color CMOS	1/2-inch Monochrome CMOS	1/2-inch color CMOS	1/2-inch Monochrome CMOS
	Shutter	Built-in lighting lit: 1/250 to 1/50,000 Built-in lighting not lit: 1/1 to 1/50,000		Built-in lighting lit: 1/250 to 1/60,000 Built-in lighting not lit: 1/1 to 1/4,155		1/1 to 1/4,155	
	Processing resolution	752×480		928×828		1280×1024	
	Partial input function	Supported horizontally only.		Supported horizontally and vertically			
	Image display	Zoom-in/Zoom-out/Fit Width/Rotate 180°					
	Lens mounts	---				C-mounts	
	Lighting	Lighting method	Pulse				---
Lighting color		White				---	
Data logging	Measurement data	In Sensor: 1,000 items (If a Touch Finder is used, results can be saved up to the capacity of an SD card.)					
	Images	In Sensor: 20 images (If a Touch Finder is used, images can be saved up to the capacity of an SD card.)					
Auxiliary function		Statistical data, test measurement, I/O monitor, password function, simulation software, sensor error history, calibration, math (arithmetic, calculation functions, trigonometric functions, and logic functions)					

Item		Single-function models	Standard models	High-resolution models			
Model	NPN	FQ2-S10□□□□	FQ2-S20□□□□	FQ2-S30□□□□-08	FQ2-S30□□□□-08M	FQ2-S30-13	FQ2-S30-13M
	PNP	FQ2-S15□□□□	FQ2-S25□□□□	FQ2-S35□□□□-08	FQ2-S35□□□□-08M	FQ2-S35-13	FQ2-S35-13M
Measurement trigger		External trigger (single or continuous) Communications trigger (Ethernet TCP no-protocol, Ethernet UDP no-protocol, Ethernet FINS/TCP no-protocol, PROFINET, EtherNet/IP, or PLC Link)					
I/O specifications	Input signals	7 signals • Single measurement input (TRIG) • Control command input (IN0 to IN5)					
	Output signals	3 signals • Control output (BUSY) • Overall judgement output (OR) • Error output (ERROR) Note: The assignments of the three output signals (OUT0 to OUT2) can also be changed to the following. • READY • RUN • STG (Strobe trigger) • OR (Item0 judgment) to OR31 (Item31 judgment) • Exp.0 judgment to Exp.31 judgment					
	Ethernet specifications	100Base-TX/10Base-T					
	Communications	Ethernet TCP no-protocol, Ethernet UDP no-protocol, Ethernet FINS/TCP no-protocol, EtherNet/IP, or PLC Link PROFINET					
	I/O expansion	---	---	Possible by connecting FQ-SDU1□ Sensor Data Unit.11 inputs and 24 outputs			
	RS-232C	---	---	Possible by connecting FQ-SDU2□ Sensor Data Unit.			
	Input specifications	Refer to Table 2.					
	Output specifications						
	Connection method	Special connector cables Power supply and I/O: 1 cable (FQ-WD□□□) Touch Finder and computer: 1 cable (FQ-WN□□□)			Special connector cables Power supply I/O and Sensor Data Units: 1 cable (FQ-WD□□□ and FQ-WU□□□) Touch Finder and computer: 1 cable (FQ-WN□□□)		
Indications		BUSY indicator (BUSY, green), Judgment result indicator (OR, orange), error indicator (ERROR, red), Ethernet communications indicator (ETN, orange) Note: The assignment of the BUSY indicator can be changed to a RUN indicator (display color: green).					
Ratings	Power supply voltage	21.6 to 26.4 VDC (including ripple)					
	Insulation resistance	Between all lead wires and case: 0.5 MΩ (at 250 V)					
	Current consumption	2.4 A max.				0.3 A max.	

Item		Single-function models	Standard models	High-resolution models			
Model	NPN	FQ2-S10□□□□	FQ2-S20□□□□	FQ2-S30□□□□-08	FQ2-S30□□□□-08M	FQ2-S30-13	FQ2-S30-13M
	PNP	FQ2-S15□□□□	FQ2-S25□□□□	FQ2-S35□□□□-08	FQ2-S35□□□□-08M	FQ2-S35-13	FQ2-S35-13M
Environmental immunity	Ambient temperature range	Operating: 0 to 50°C Storage: -25 to 65°C (with no icing or condensation)		Operating: 0 to 40°C, Storage: -25 to 65°C (with no icing or condensation)			
	Ambient humidity range	Operating and storage: 35% to 85% (with no condensation)					
	Ambient atmosphere	No corrosive gas					
	Vibration resistance (destruction)	10 to 150 Hz, single amplitude: 0.35 mm, X/Y/Z directions 8 min each, 10 times					
	Shock resistance (destruction)	150 m/s ² 3 times each in 6 direction (up, down, right, left, forward, and backward)					
	Degree of protection	IEC 60529 IP67 (Except when Polarizing Filter Attachment is mounted or connector cap is removed.)				IEC 60529 IP40	
Materials	Sensor: PBT, PC, SUS Mounting Bracket: PBT Polarizing Filter Attachment: PBT, PC Ethernet connector: Oil-resistance vinyl compound I/O connector: Lead-free heat-resistant PVC				Cover: Zinc-plated steel, Thickness: 0.6 mm Case: Aluminum diecast alloy (ADC-12) Mounting base: Polycarbonate ABS		
Weight	Depends on field of view and installation distance. Refer to Table 1.				Approx. 160 g without base, Approx. 185 g with base		
Accessories	Mounting Bracket (FQ-XL) (1) Polarizing Filter Attachment (FQ-XF1) (1) Instruction Manual Member Registration Sheet				Mounting Base (FQ-XLC) (1) Four Mounting Screws (FQ-XLC) (M3×8 mm)(4) Instruction Manual Member Registration Sheet		
LED class ²	Risk Group 2				---		

Table 1

Single-function models		Standard models		Field of view (H×V) *3	Installation distance	Number of LEDs	Weight
NPN	PNP	NPN	PNP				
FQ2-S10010F	FQ2-S15010F	FQ2-S20010F	FQ2-S25010F	7.5 × 4.7 to 13 × 8.2 mm	38 to 57 mm	4	Approx. 160 g
FQ2-S10050F	FQ2-S15050F	FQ2-S20050F	FQ2-S25050F	13 × 8.2 to 53 × 33 mm	56 to 215 mm	4	
FQ2-S10100F	FQ2-S15100F	FQ2-S20100F	FQ2-S25100F	53 × 33 to 240 × 153 mm	220 to 970 mm	8	Approx. 150 g
FQ2-S10100N	FQ2-S15100N	FQ2-S20100N	FQ2-S25100N	29 × 18 to 300 × 191 mm	32 to 380 mm	8	

High-resolution models		Field of view (H×V) *3	Installation distance	Number of LEDs	Weight
NPN	PNP				
FQ2-S30010F-□□□	FQ2-S35010F-□□□	7.5×6.7 to 13×11.6 mm	38 to 57 mm	4	Approx. 160 g
FQ2-S30050F-□□□	FQ2-S35050F-□□□	13×11.6 to 53×47.3 mm	56 to 215 mm	4	
FQ2-S30100F-□□□	FQ2-S35100F-□□□	53×47.3 to 240×214 mm	220 to 970 mm	8	Approx. 150 g
FQ2-S30100N-□□□	FQ2-S35100N-□□□	29×25.9 to 300×268 mm	32 to 380 mm	8	

*1: Registration may not be possible for all scenes, depending on the settings.

*2: Applicable standards: IEC62471-2

*3: Tolerance: ±10% max.

Table 2

Item	NPN	PNP
Input specifications	ON: Shorted to 0 V, or 1.5 V max. OFF: Open (leakage current: 0.1 mA max.)	ON: Shorted to power supply voltage, or power supply voltage -1.5 V max. OFF: Open (leakage current: 0.1 mA max.)
Output specifications ³	NPN open collector 30 VDC, 50 mA max., residual voltage: 2.0 V max.	PNP open collector 30 VDC, 50 mA max., residual voltage: 2.0 V max.

*4: Do not allow the load current to exceed 50 mA. The output circuit may be damaged if the load current exceeds 50 mA.

FQ2-S4 Series

Item		Inspection and ID models					
Model	NPN	FQ2-S40□□□□	FQ2-S40□□□□-M	FQ2-S40□□□□-08	FQ2-S40□□□□-08M	FQ2-S40-13	FQ2-S40-13M
	PNP	FQ2-S45□□□□	FQ2-S45□□□□-M	FQ2-S45□□□□08	FQ2-S45□□□□-08M	FQ2-S45-13	FQ2-S45-13M
Field of view		Refer to Table 1.				Lens is select according to the field of vision and installation distance. Refer to the Optical Chart page.	
Installation distance		Refer to Table 1.					
Main functions	Inspection items	Shape Search II, Search, Sensitive Search, Edge Position, Edge Width, Edge Pitch, Area, Color Data, Labeling, OCR, Bar Code, 2D Code, 2D Code (DPM), and Model Dictionary					
	Number of simultaneous measurements	32					
	Position compensation	Supported (360° Model position compensation, Edge position compensation, Linear correction)					
	Number of registered scenes*1	32					
	Calibration	Supported					
	Retrying	Normal retry, exposure retry, scene retry, and trigger retry					
	Print quality	ISO/IEC TR 29158 (AIM DPM-1-2006) (Supports code : Datamatrix ECC200)					
Image input	Image processing method	Real color	Monochrome	Real color	Monochrome	Real color	Monochrome
	Image filter	High dynamic range (HDR), pre-processing (color gray filter (Sensors with Color Cameras only), weak smoothing, strong smoothing, dilate, erosion, median, extract edges, extract horizontal edges, extract vertical edges, enhance edges, and background suppression), polarizing filter (attachment), white balance (Sensors with Color Cameras only), and brightness correction					
	Image elements	1/3-inch color CMOS	1/3-inch Monochrome CMOS	1/2-inch color CMOS	1/2-inch Monochrome CMOS	1/2-inch color CMOS	1/2-inch Monochrome CMOS
	Shutter	Built-in lighting lit: 1/250 to 1/50,000 Built-in lighting not lit: 1/1 to 1/50,000		Built-in lighting lit: 1/250 to 1/60,000 Built-in lighting not lit: 1/1 to 1/4,155		1/1 to 1/4,155	
	Processing resolution	752×480		928×828		1,280×1,024	
	Partial input function	Supported horizontally only.		Supported horizontally and vertically			
	Image display	Zoom-in/Zoom-out/Fit Width/Rotate 180°					
	Lens mounts	---				C-mounts	
Lighting	Lighting method	Pulse				---	
	Lighting color	White				---	
Data logging	Measurement data	In Sensor: 1,000 items (If a Touch Finder is used, results can be saved up to the capacity of an SD card.)					
	Images	In Sensor: 20 images (If a Touch Finder is used, images can be saved up to the capacity of an SD card.)					
Auxiliary function		Statistical data, test measurement, I/O monitor, password function, simulation software, sensor error history, calibration, math (arithmetic, calculation functions, trigonometric functions, and logic functions)					
Measurement trigger		External trigger (single or continuous) Communications trigger (Ethernet TCP no-protocol, Ethernet UDP no-protocol, Ethernet FINS/TCP no-protocol, EtherNet/IP, PROFINET, or PLC Link)					

Item		Inspection and ID models					
Model	NPN	FQ2-S40□□□□	FQ2-S40□□□□-M	FQ2-S40□□□□-08	FQ2-S40□□□□-08M	FQ2-S40-13	FQ2-S40-13M
	PNP	FQ2-S45□□□□	FQ2-S45□□□□-M	FQ2-S45□□□□08	FQ2-S45□□□□-08M	FQ2-S45-13	FQ2-S45-13M
I/O specifications	Input signals	7 signals <ul style="list-style-type: none"> • Single measurement input (TRIG) • Control command input (IN0 to IN5) 					
	Output signals	3 signals <ul style="list-style-type: none"> • Control output (BUSY) • Overall judgement output (OR) • Error output (ERROR) Note: The assignments of the three output signals (OUT0 to OUT2) can also be changed to the following. <ul style="list-style-type: none"> • READY • RUN • STG (Strobe trigger) • OR (Item0 judgment) to OR31 (Item31 judgment) • Exp.0 judgment to Exp.31 judgment 					
	Ethernet specifications	100Base-TX/10Base-T					
	Communications	Ethernet TCP no-protocol, Ethernet UDP no-protocol, Ethernet FINS/TCP no-protocol, EtherNet/IP, PLC Link, or PROFINET					
	I/O expansion	Possible by connecting FQ-SDU1□ Sensor Data Unit. 11 inputs and 32 outputs					
	RS-232C	Possible by connecting FQ-SDU2□ Sensor Data Unit..					
	Input specifications	Refer to Table 2.					
	Output specifications	Refer to Table 2.					
	Connection method	Special connector cables Power supply and I/O: 1 cable (FQ-WD□□□□) Touch Finder and computer: 1 cable (FQ-WN□□□□)			Special connector cables Power supply I/O and Sensor Data Unit.s: 1 cable (FQ-WD□□□□ and FQ-WU□□□□) Touch Finder and computer: 1 cable (FQ-WN□□□□)		
	Indications	BUSY indicator (BUSY, green), Judgement result indicator (OR, orange), error indicator (ERROR, red), Ethernet communications indicator (ETN, orange) Note: The assignment of the BUSY indicator can be changed to a RUN indicator (display color: green).					
Ratings	Power supply voltage	21.6 to 26.4 VDC (including ripple)					
	Insulation resistance	Between all lead wires and case: 0.5 MΩ (at 250 V)					
	Current consumption	2.4 A max.				0.3 A max.	

Item		Inspection and ID models					
Model	NPN	FQ2-S40□□□□	FQ2-S40□□□□-M	FQ2-S40□□□□-08	FQ2-S40□□□□-08M	FQ2-S40-13	FQ2-S40-13M
	PNP	FQ2-S45□□□□	FQ2-S45□□□□-M	FQ2-S45□□□□08	FQ2-S45□□□□-08M	FQ2-S45-13	FQ2-S45-13M
Environmental immunity	Ambient temperature range	Operating: 0 to 50°C Storage: -25 to 65°C (with no icing or condensation)					
	Ambient humidity range	Operating and storage: 35% to 85% (with no condensation)					
	Ambient atmosphere	No corrosive gas					
	Vibration resistance (destruction)	10 to 150 Hz, single amplitude: 0.35 mm, X/Y/Z directions 8 min each, 10 times					
	Shock resistance (destruction)	150 m/s ² 3 times each in 6 direction (up, down, right, left, forward, and backward)					
	Degree of protection	IEC 60529 IP67 (Except when Polarizing Filter Attachment is mounted or connector cap is removed.)				IEC 60529 IP40	
Materials	Sensor: PBT, PC, SUS Mounting Bracket: PBT Polarizing Filter Attachment: PBT, PC Ethernet connector: Oil-resistance vinyl compound I/O connector: Lead-free heat-resistant PVC					Cover: Zinc-plated steel, Thickness: 0.6 mm Case: Aluminum diecast alloy (ADC-12) Mounting base: Polycarbonate ABS	
Weight	Depends on field of view and installation distance. Refer to Table 1.					Approx. 160 g without base, Approx. 185 g with base	
Accessories	Mounting Bracket (FQ-XL)(1) Polarizing Filter Attachment (FQ-XF1) (1) Instruction Manual Member Registration Sheet					Mounting Base (1) Four Mounting Screws (M3×8 mm)(4) Instruction Manual Member Registration Sheet	
LED class ^{*2}	Risk Group 2					---	

Table 1

350,000-pixel Models		Field of view (H×V) *3	Installation distance	Number of LEDs	Weight
NPN	PNP				
FQ2-S40010F-□	FQ2-S45010F-□	7.5 × 4.7 to 13 × 8.2 mm	38 to 57 mm	4	Approx. 160 g
FQ2-S40050F-□	FQ2-S45050F-□	13 × 8.2 to 53 × 33 mm	56 to 215 mm	4	
FQ2-S40100F-□	FQ2-S45100F-□	53 × 33 to 240 × 153 mm	220 to 970 mm	8	Approx. 150 g
FQ2-S40100N-□	FQ2-S45100N-□	29 × 18 to 300 × 191 mm	32 to 380 mm	8	

760,000-pixel Models		Field of view (H×V) *3	Installation distance	Number of LEDs	Weight
NPN	PNP				
FQ2-S40010F-□□□	FQ2-S45010F-□□□	7.5×6.7 to 13×11.6 mm	38 to 57 mm	4	Approx. 160 g
FQ2-S40050F-□□□	FQ2-S45050F-□□□	13×11.6 to 53×47.3 mm	56 to 215 mm	4	
FQ2-S40100F-□□□	FQ2-S45100F-□□□	53×47.3 to 240×214 mm	220 to 970 mm	8	Approx. 150 g
FQ2-S40100N-□□□	FQ2-S45100N-□□□	29×25.9 to 300×268 mm	32 to 380 mm	8	

*1: Registration may not be possible for all scenes, depending on the settings.

*2: Applicable standards: IEC62471-2

*3: Tolerance: ±10% max.

Table 2

Item	NPN	PNP
Input specifications	ON: Shorted to 0 V, or 1.5 V max. OFF: Open (leakage current: 0.1 mA max.)	ON: Shorted to power supply voltage, or power supply voltage -1.5 V max. OFF: Open (leakage current: 0.1 mA max.)
Output specifications ³	NPN open collector 30 VDC, 50 mA max., residual voltage: 2.0 V max.	PNP open collector 30 VDC, 50 mA max., residual voltage: 2.0 V max.

*4: Do not allow the load current to exceed 50 mA. The output circuit may be damaged if the load current exceeds 50 mA.

FQ2-CH Series

Item		Inspection and ID models
Model	NPN	FQ2-CH10□□□□-M
	PNP	FQ2-CH15□□□□--M
Field of view		Refer to Table 1.
Installation distance		Refer to Table 1.
Main functions	Inspection items	OCR, and Model Dictionary
	Number of simultaneous measurements	32
	Position compensation	Supported (360° Model position compensation, Edge position compensation, Linear correction)
	Number of registered scenes	32
	Retrying	Normal retry, exposure retry, scene retry, and trigger retry
Image input	Image processing method	Monochrome
	Image filter	High dynamic range (HDR), pre-processing (weak smoothing, strong smoothing, dilate, erosion, median, extract edges, extract horizontal edges, extract vertical edges, enhance edges, and background suppression), polarizing filter (attachment), and brightness correction
	Image elements	1/3-inch Monochrome CMOS
	Shutter	Built-in lighting lit: 1/250 to 1/50,000 Built-in lighting not lit: 1/1 to 1/50,000
	Processing resolution	752×480
	Partial input function	Supported horizontally only.
	Image display	Zoom-in/Zoom-out/Fit Width/Rotate 180°
Lighting	Lighting method	Pulse
	Lighting color	White
Data logging	Measurement data	In Sensor: 1,000 items (If a Touch Finder is used, results can be saved up to the capacity of an SD card.)
	Images	In Sensor: 20 images (If a Touch Finder is used, images can be saved up to the capacity of an SD card.)
Auxiliary function		Statistical data, test measurement, I/O monitor, password function, simulation software, sensor error history, math (arithmetic, calculation functions, trigonometric functions, and logic functions)
Measurement trigger		External trigger (single or continuous) Communications trigger (Ethernet TCP no-protocol, Ethernet UDP no-protocol, Ethernet FINS/TCP no-protocol, EtherNet/IP, PROFINET, or PLC Link)

Item		Inspection and ID models
Model	NPN	FQ2-CH10□□□□-M
	PNP	FQ2-CH15□□□□--M
I/O specifications	Input signals	7 signals <ul style="list-style-type: none"> • Single measurement input (TRIG) • Control command input (IN0 to IN5)
	Output signals	3 signals <ul style="list-style-type: none"> • Control output (BUSY) • Overall judgement output (OR) • Error output (ERROR) Note: The assignments of the three output signals (OUT0 to OUT2) can also be changed to the following. <ul style="list-style-type: none"> • READY • RUN • STG (Strobe trigger) • OR (Item0 judgment) to OR31 (Item31 judgment) • Exp.0 judgment to Exp.31 judgment
	Ethernet specifications	100Base-TX/10Base-T
	Communications	Ethernet TCP no-protocol, Ethernet UDP no-protocol, Ethernet FINS/TCP no-protocol, EtherNet/IP, PLC Link, or PROFINET
	I/O expansion	Possible by connecting FQ-SDU1□ Sensor Data Unit.. 11 inputs and 32 outputs
	RS-232C	Possible by connecting FQ-SDU2□ Sensor Data Unit..
	Input specifications	Refer to Table 2.
	Output specifications	
Connection method	Special connector cables Power supply and I/O: 1 cable (FQ-WD□□□) Touch Finder and computer: 1 cable (FQ-WN□□□)	
Indications		BUSY indicator (BUSY, green), Judgement result indicator (OR, orange), error indicator (ERROR, red), Ethernet communications indicator (ETN, orange) Note: The assignment of the BUSY indicator can be changed to a RUN indicator (display color: green).
Ratings	Power supply voltage	21.6 to 26.4 VDC (including ripple)
	Insulation resistance	Between all lead wires and case: 0.5 MΩ (at 250 V)
	Current consumption	2.4 A max.
Environmental immunity	Ambient temperature range	Operating: 0 to 50°C Storage: -25 to 65°C (with no icing or condensation)
	Ambient humidity range	Operating and storage: 35% to 85% (with no condensation)
	Ambient atmosphere	No corrosive gas
	Vibration resistance (destruction)	10 to 150 Hz, single amplitude: 0.35 mm, X/Y/Z directions 8 min each, 10 times
	Shock resistance (destruction)	150 m/s ² 3 times each in 6 direction (up, down, right, left, forward, and backward)
	Degree of protection	IEC 60529 IP67 (Except when Polarizing Filter Attachment is mounted or connector cap is removed.)
Materials		Sensor: PBT, PC, SUS Mounting Bracket: PBT Polarizing Filter Attachment: PBT, PC Ethernet connector: Oil-resistance vinyl compound I/O connector: Lead-free heat-resistant PVC
Weight		Depends on field of view and installation distance. Refer to Table 1.

Item		Inspection and ID models
Model	NPN	FQ2-CH10□□□□-M
	PNP	FQ2-CH15□□□□--M
Accessories		Mounting Bracket (FQ-XL)(1) Polarizing Filter Attachment (FQ-XF1) (1) Instruction Manual Member Registration Sheet
LED class ^{*2}		Risk Group 2

Table 1

350,000-pixel Models		Field of view (H×V) *1	Installation distance	Number of LEDs	Weight
NPN	PNP				
FQ2-CH10010F-M	FQ2-CH15010F-M	7.5 × 4.7 to 13 × 8.2 mm	38 to 57 mm	4	Approx. 160 g
FQ2-CH10050F-M	FQ2-CH15050F-M	13 × 8.2 to 53 × 33 mm	56 to 215 mm	4	
FQ2-CH10100F-M	FQ2-CH15100F-M	53 × 33 to 240 × 153 mm	220 to 970 mm	8	Approx. 150 g
FQ2-CH10100N-M	FQ2-CH15100N-M	29 × 18 to 300 × 191 mm	32 to 380 mm	8	

*1: Tolerance: ±10% max.

*2: Applicable standards: IEC62471-2

Table 2

Item	NPN	PNP
Input specifications	ON: Shorted to 0 V, or 1.5 V max. OFF: Open (leakage current: 0.1 mA max.)	ON: Shorted to power supply voltage, or power supply voltage -1.5 V max. OFF: Open (leakage current: 0.1 mA max.)
Output specifications ^{*3}	NPN open collector 30 VDC, 50 mA max., residual voltage: 2.0 V max.	PNP open collector 30 VDC, 50 mA max., residual voltage: 2.0 V max.

*3: Do not allow the load current to exceed 50 mA. The output circuit may be damaged if the load current exceeds 50 mA.

Dimensions

FQ2-S10010F/-S10050F
 FQ2-S15010F/-S15050F
 FQ2-S40010F/-S40010F-M/-S40050F/-S40050F-M
 FQ2-S45010F/-S45010F-M/-S45050F/-S45010F-M
 FQ2-CH10010F-M/-CH10050F-M
 FQ2-CH15010F-M/-CH15050F-M
 FQ2-S30010F-08/-S35010F-08/-S30010F-08M/-S35010F-08M
 FQ2-S30050F-08/-S35050F-08/-S30050F-08M/-S35050F-08M
 FQ2-S40010F-08/-S45010F-08/-S40010F-08M/-S45010F-08M
 FQ2-S40050F-08/-S45050F-08/-S40050F-08M/-S45050F-08M

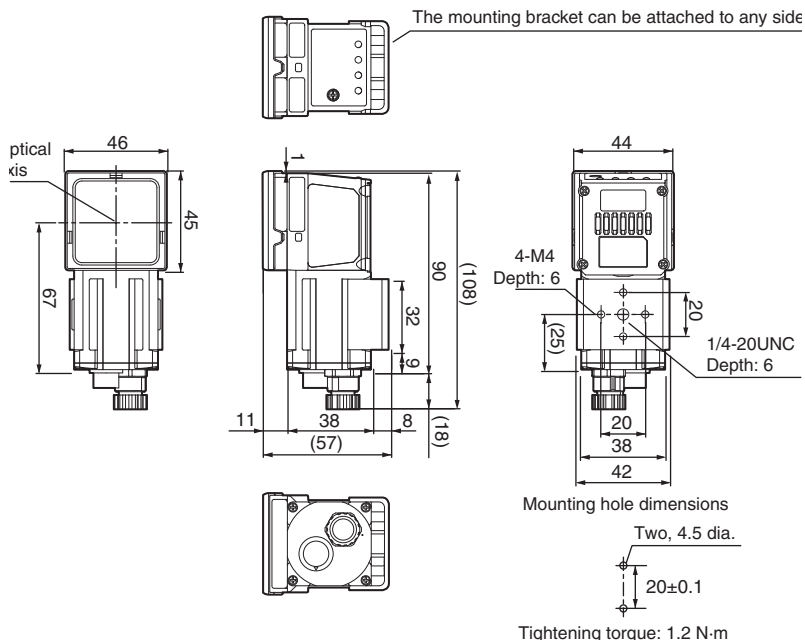

FQ2-S10100F/-S10100N/-S20100N
 FQ2-S15100F/-S15100N/-S25100N
 FQ2-S40100F/-S40100N/-S40100N
 FQ2-S45100F/-S45100N/-S45100N
 FQ2-CH10100F-M/-CH10100N-M
 FQ2-CH15100F-M/-CH15100N-M
 FQ2-S30100F-08/-S35100F-08/-S30100F-08M/-S35100F-08M
 FQ2-S30100N-08/-S35100N-08/-S30100N-08M/-S35100N-08M
 FQ2-S40100F-08/-S45100F-08/-S40100F-08M/-S45100F-08M
 FQ2-S40100N-08/-S45100N-08/-S40100N-08M/-S45100N-08M

FQ2-S20100F
 FQ2-S25100F
 FQ2-S40100F
 FQ2-S45100F

(Unit: mm)

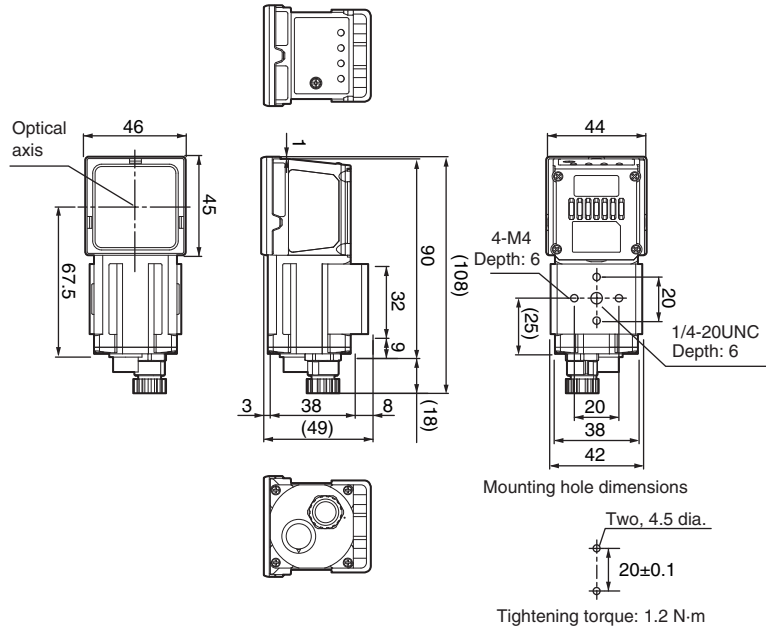

See the diagram below when mounting bracket FQ-XL2 is attached.

(Unit: mm)

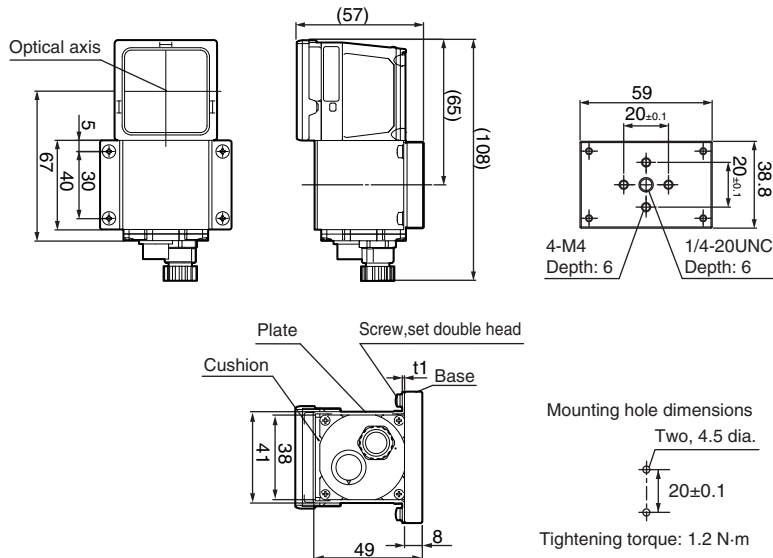

FQ2-S30-13/-S35-13/-S30-13M/-S35-13M
 FQ2-S40-13/-S45-13/-S40-13M/-S45-13M

(Unit: mm)

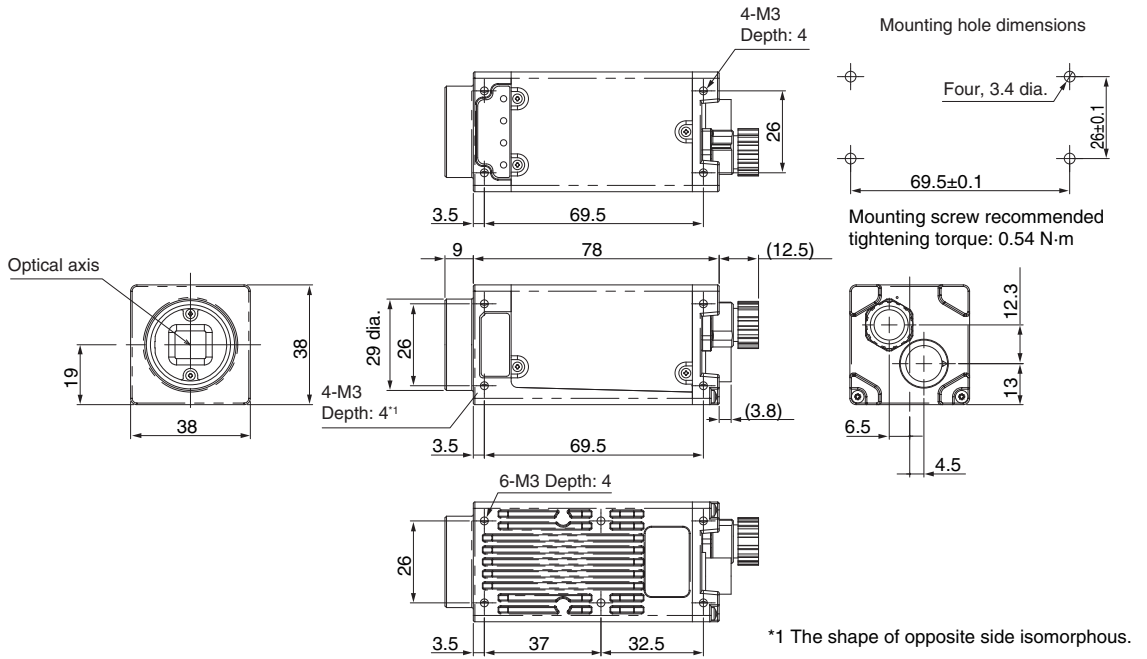

Mounting Base (FQ2-S□□ only)

(Unit: mm)

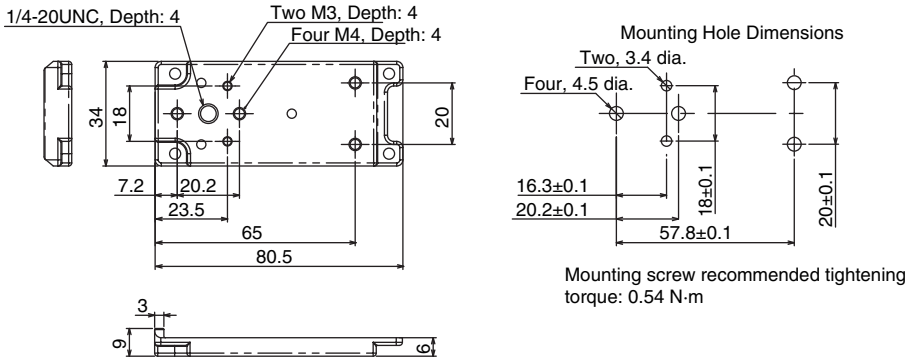

Touch Finder

Specifications

Item		Model with DC power supply		Model with AC/DC/battery power supply	
		FQ2-D30		FQ2-D31	
Number of connectable Sensors		Number of sensors that can be recognized (switched): 32, number or sensor that can displayed on monitor: 8			
Main functions	Types of measurement displays		Last result display, last NG display, trend monitor, histograms		
	Types of display images		Through, frozen, zoom-in, and zoom-out images		
	Data logging		Measurement results, measured images		
	Menu language		English, German, French, Italian, Spanish, Traditional Chinese, Simplified Chinese, Korean, or Japanese		
Indications	LCD	Display device	3.5-inch TFT color LCD		
		Pixels	320 × 240		
		Display colors	16,777,216		
	Backlight	Life expectancy ¹	50,000 hours at 25°C		
		Brightness adjustment	Provided		
		Screen saver	Provided (The time setting can be changed.)		
	Indicators		Power indicator (color: green): POWER Error indicator (color: red): ERROR SD card access indicator (color: yellow): SD ACCESS	Power indicator (color: green): POWER Error indicator (color: red): ERROR SD card access indicator (color: yellow): SD ACCESS Charge indicator (color: orange): CHARGE	
Operation interface	Touch screen	Method	Resistance film		
		Life expectancy ³	1,000,000 operations		
External interface	Ethernet		100BASE-TX/10BASE-T		
	SD card		SDHC-compliant, Class 4 or higher recommended, FAT/FAT32 formatted.		
Battery	Charging function		No	Yes ²	
Ratings	Power supply voltage		DC power connection: 21.6 to 26.4 VDC (including ripple)	DC power connection: 21.6 to 26.4 VDC (including ripple) AC adapter (manufactured by Sino-American Japan Co., Ltd) connection: 100 to 240 VAC, 50/60 Hz Battery connection: FQ-BAT1 Battery (1 cell, 3.7 V)	
	Continuous operation on Battery ⁴		---	1.5 h	
	Current consumption		DC power connection: 0.2 A max.	DC power connection: 0.2 A max., Charging battery: 0.4 A max.	
	Insulation resistance		Between all lead wires and case: 0.5 MΩ (at 250 V)		

Item		Model with DC power supply	Model with AC/DC/battery power supply
		FQ2-D30	FQ2-D31
Environmental immunity	Ambient temperature range	Operating: 0 to 50°C Storage: -25 to 65°C (with no icing or condensation)	Operating: 0 to 50°C when mounted to DIN Track or panel 0 to 40°C when operated on a Battery Storage: -25 to 65°C (with no icing or condensation)
	Ambient humidity range	Operating and storage: 35% to 85% (with no condensation)	
	Ambient atmosphere	No corrosive gas	
	Vibration resistance (destruction)	10 to 150 Hz, single amplitude: 0.35 mm, X/Y/Z directions 8 min each, 10 times	
	Shock resistance (destruction)	150 m/s ² 3 times each in 6 direction (up, down, right, left, forward, and backward)	
	Degree of protection	IEC 60529 IP20	
Weight		Approx. 270 g (without Battery and hand strap)	
Dimensions		95 × 85 × 32.5 mm	
Materials		Case: ABS	
Accessories		Touch Pen (FQ-XT), Instruction Manual	

- *1 This is a guideline for the time required for the brightness to diminish to half the initial brightness at room temperature and humidity. No guarantee is implied. The life of the backlight is greatly affected by the ambient temperature and humidity. It will be shorter at lower or higher temperatures.
- *2 The battery can only be charged when the Touch Finder power is switched OFF.
- *3 This value is only a guideline. No guarantee is implied. The value will be affected by operating conditions.
- *4 This value is only a guideline. No guarantee is implied. The value will be affected by the operating environment and operating conditions.

• Battery Specifications

Item	FQ-BAT1
Battery type	Secondary lithium ion battery
Nominal capacity	1,800 mAh
Rated voltage	3.7 V
Dimensions	35.3 × 53.1 × 11.4 mm
Ambient temperature range	Operating: 0 to 40°C Storage: -25 to 65°C (with no icing or condensation)
Ambient humidity range	Operating and storage: 35% to 85% (with no condensation)
Charging method	Charged in Touch Finder (FQ2-D31).
Charging time ^{*1}	2 h
Usage time ^{*1}	1.5 h
Battery backup life ^{*2}	300 charging cycles
Weight	50 g max.

- *1 This value is only a guideline. No guarantee is implied. The value will be affected by operating conditions
- *2 This is a guideline for the time required for the capacity of the Battery to be reduced to 60% of the initial capacity. No guarantee is implied. The value will be affected by the operating environment and operating conditions.

Dimensions

FQ2-D30/-D31

(Unit: mm)

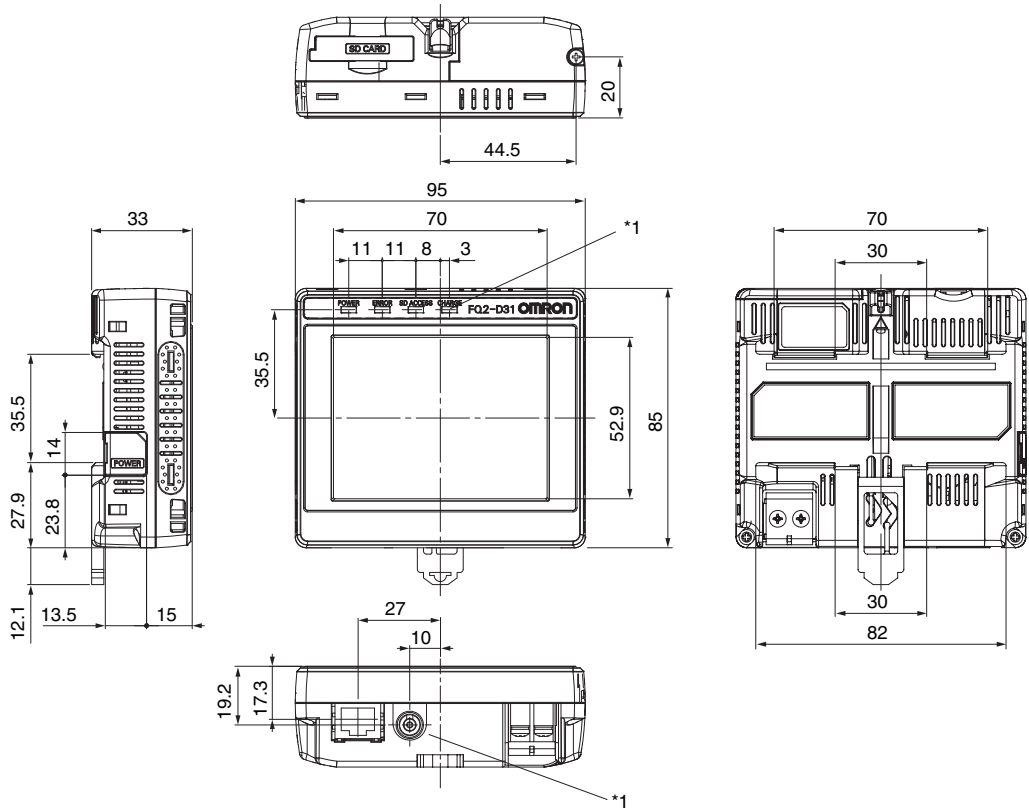

*1: Provided on the FQ2-D31 only.

Panel Mounting Adapter (FQ-XPM)

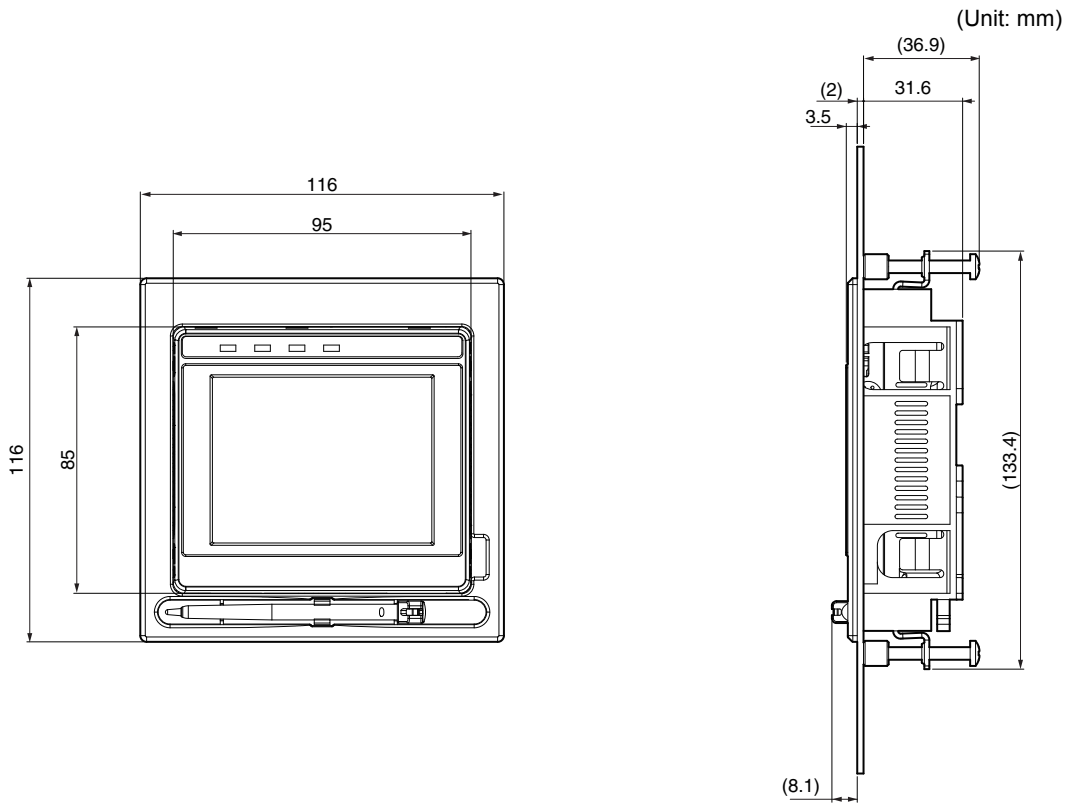

Panel cutout dimensions

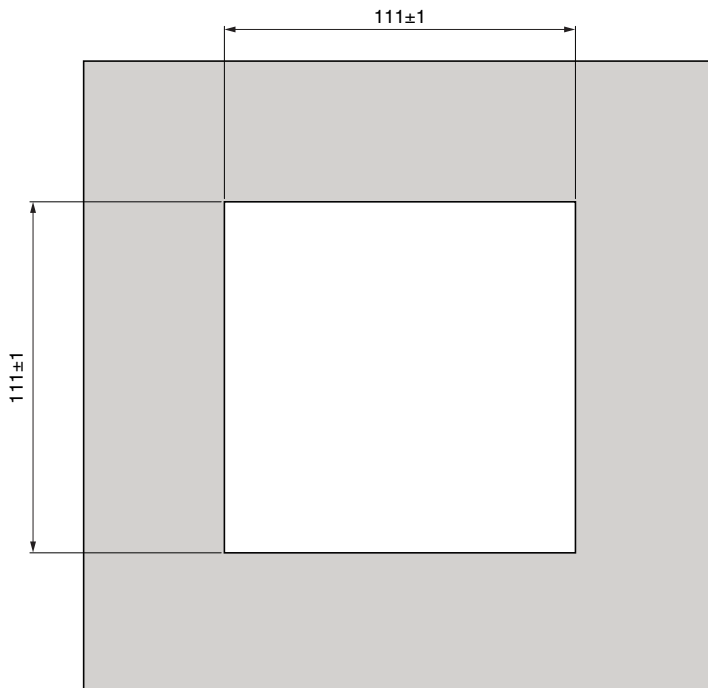

Sensor Data Units

Specifications

Item		Sensor Data Units	
		FQ-SDU1□□ Parallel Interface Sensor Data Unit (SDU10: NPN, SDU15: PNP) FQ-SDU2□ RS-232C Interface Sensor Data Unit (SDU20: NPN, SDU25: PNP)	
I/O specifications	Parallel I/O	SDU1□	11 inputs (TRIG, RESET, IN0 to IN7, and DSA) 24 outputs (GATE, D0 to D15, ACK, RUN, BUSY, OR, ERROR, STGOUT, and SHTOUT)
		SDU2□	8 inputs (IN0 to IN5, TRIG, and RESET) 7 outputs (ACK, RUN, BUSY, OR, ERROR, STGOUT, SHTOUT)
	RS-232C		1 channel, 115,200 bps max. *FQ-SDU2□ only.
	Sensor interface		FQ2-S3, FQ2-S4, FQ2-CH connected with FQ-WU□□□): OMRON interface *Number of connected Sensors: 1
	Input specifications		Refer to Table 2.
	Output specifications		
Ratings	Power supply voltage		21.6 to 26.4 VDC (including ripple)
	Insulation resistance		Between all DC external terminals and case: 0.5 MΩ min. (at 250 VDC)
	Current consumption		2.5 A max. (FQ2-CH, FQ2-S□□□□□□□□□□ + FQ-SDU□□) 0.4 A max. (FQ2-S3□□□□□ + FQ-SDU□□, FQ2-S4□□□□□ + FQ-SDU□□) 0.1 A max. (for FQ-SDU□□)
Environmental immunity	Ambient temperature range		Operating: 0 to 50°C, Storage: -20 to 65°C (with no icing or condensation)
	Ambient humidity range		Operating and storage: 35% to 85% (with no condensation)
	Ambient atmosphere		No corrosive gas
	Vibration resistance (destruction)		10 to 150 Hz, single amplitude: 0.35 mm, X/Y/Z directions, 8 min each, 10 times
	Shock resistance (destruction)		150 m/s ² 3 times each in 6 directions (up, down, right, left, forward, and backward)
	Degree of protection		IEC 60529 IP20
Materials		Case: PC + ABS, PC	
Size		62 × 90 × 65 (W×H×D) (Excluding connectors, DIN Track, and protrusions.)	
Weight		Approx. 150 g	
Accessories		Instruction Manual	

Table 1

Item	NPN	PNP
Input specifications	ON: Shorted to 0 V, or 1.5 V max. OFF: Open (leakage current: 0.1 mA max.)	ON: Shorted to power supply voltage, or power supply voltage -1.5 V max. OFF: Open (leakage current: 0.1 mA max.)
Output specifications ¹	NPN open collector 30 VDC, 50 mA max., residual voltage: 1.2 V max.	PNP open collector 30 VDC, 50 mA max., residual voltage: 1.2 V max.

*1: Do not allow the load current to exceed 50 mA. The output circuit may be damaged if the load current exceeds 50 mA.

Dimensions

FQ-SDU10/-SDU15

(Unit: mm)

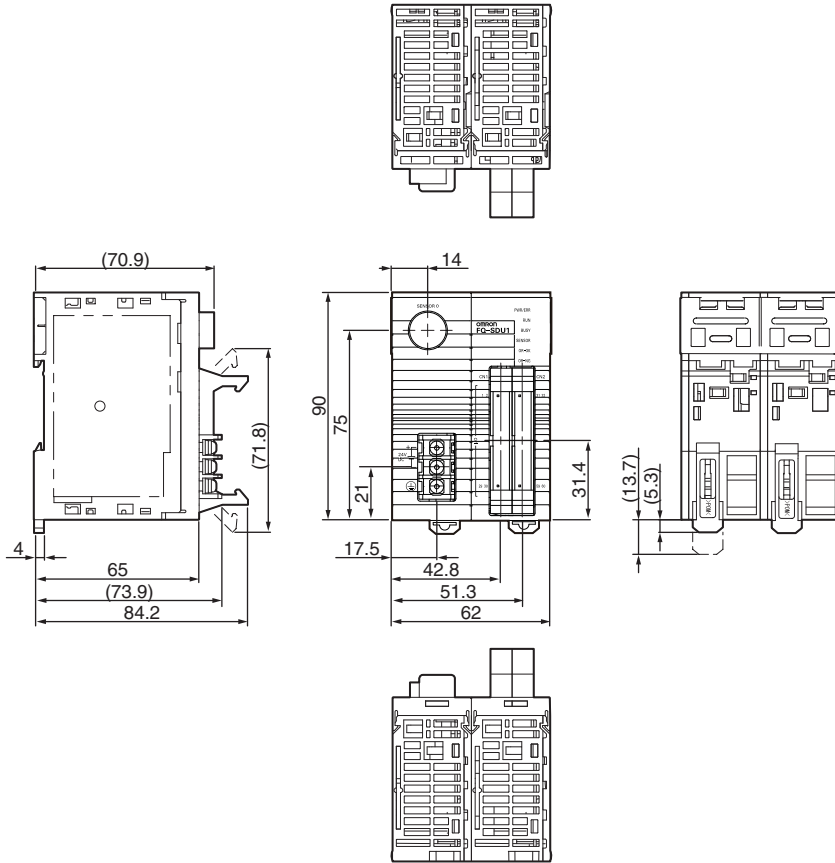

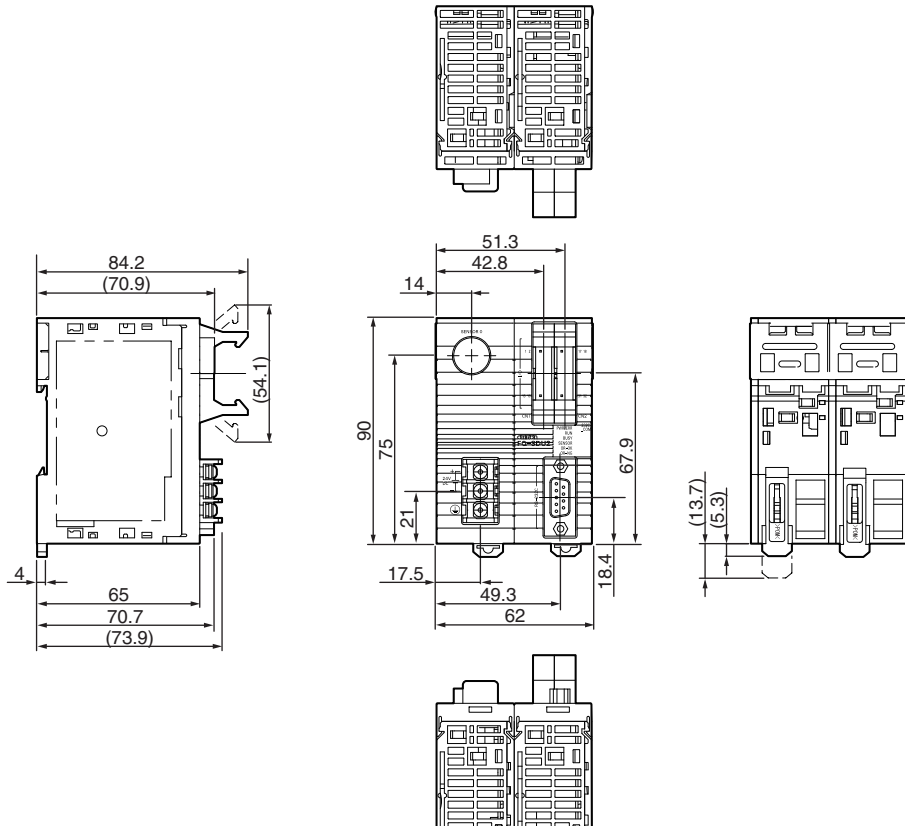

System Requirements for PC Tool for FQ

The system requirements for the PC Tool are given in the following table.

Item	Requirement
OS	<ul style="list-style-type: none"> Microsoft Windows 7 Home Premium or higher (32-bit edition or 64-bit edition) Microsoft Windows 8.1 Pro Edition or higher (32-bit edition or 64-bit edition) Microsoft Windows 10 Home Edition or higher (32-bit edition or 64-bit edition)
Hardware	<ul style="list-style-type: none"> CPU: Core 2 Duo 1.06 GHz or the equivalent or higher RAM: 1 GB min. HDD: 500 MB min. available space^{*1} Monitor: 1,024 x 768 dots min.

*1. Available space is also required separately for data logging.

Options

Specifications

• I/O Cables

Item	Model	FQ-WD002	FQ-WD005	FQ-WD010	FQ-WD020
Cable length		2 m	5 m	10 m	20 m
Cable type		Robot cable			
Wire gauge	Power line	AWG24		AWG24 to AWG20	
	Other lines	AWG28			
Cable diameter		6.4		6.4 to 6.7	
Minimum bending radius		41.4 mm			
Weight		100 g	250g	500 g	1500 g

• FQ Ethernet Cable

Item	Model	FQ-WN002	FQ-WD005	FQ-WN010	FQ-WN020
Cable length		2 m	5 m	10 m	20 m
Cable type		Robot cable			
Minimum bending radius		40 mm			
Weight		125 g	310 g	620 g	1780 g

• Parallel Cable for FQ-SDU1

Item	Model	FQ-VP1002	FQ-VP1005	FQ-VP1010
Applicable Units		FQ-SDU1□		
Cable length		2 m	5 m	10 m
Cable type		Flat cable		
Minimum bending radius		5.5 mm		
Weight		150 g	380 g	750 g

Important

Do not bend any Cable beyond the specified minimum bending radius. Doing so may damage the Cable.

• **Parallel Cable for FQ-SDU2**

Item	Model	FQ-VP2002	FQ-VP2005	FQ-VP2010
Applicable Units		FQ-SDU2□		
Cable length		2 m	5 m	10 m
Cable type		Flat cable		
Minimum bending radius		5.5 mm		
Weight		80 g	200 g	400 g

• **Sensor Data Unit Cable**

Item	Model	FQ-WU002	FQ-WU005	FQ-WU010	FQ-WU020
Cable length		2 m	5 m	10 m	20 m
Cable type		Robot cable			
Cable diameter		7			
Minimum bending radius		35 mm			
Weight		200 g	400 g	800 g	1500 g

Important

Do not bend any Cable beyond the specified minimum bending radius. Doing so may damage the Cable.

• **AC Adapter**

Item	Model	FQ-AC1	FQ-AC2	FQ-AC3	FQ-AC4	FQ-AC5	FQ-AC6
Plug type		A	A	A	C	BF	O
Certified standards		PSE	UL/CSA	CCC mark	---	---	---
Input voltage		100 to 240 VAC (90 to 264 VAC)					
Input current		0.4 A max., 100 VAC, 50 Hz when connected to maximum load					
Input frequency		47 to 63 Hz					
Output voltage		15 VDC±5%					
Output current		1 A max.					
Ambient temperature range		Operating: 0 to 40°C Storage: -20 to 65°C (with no icing or condensation)					
Ambient humidity range		Operating and storage: 35% to 80% (with no condensation)					
Material		Case: PPE					
Cable length		1.5 m					
Dimensions		78 × 50 × 30 mm (without power cable)					
Weight		Approx. 270 g					
Contents of label on AC Adapter		<p>The label on the AC adapter provides the following information: SINO-AMERICAN MODEL 型号: SA115B-15U SWITCHING ADAPTER 电源适配器 INPUT输入: 100-240V~ 50-60Hz 0.4A OUTPUT输出: 15V 1A 15W It also features several certification marks: JIS (Japan Industrial Standards), UL LISTED (Underwriters Laboratories), GS (Germanischer Lloyd), CCC (China Compulsory Certification), and CE (Conformité Européenne). The manufacturer information at the bottom states: 原产地: 中国 (Origin: China) and MADE IN CHINA.</p>					

Dimensions

I/O Cables

FQ-WD002/WD005

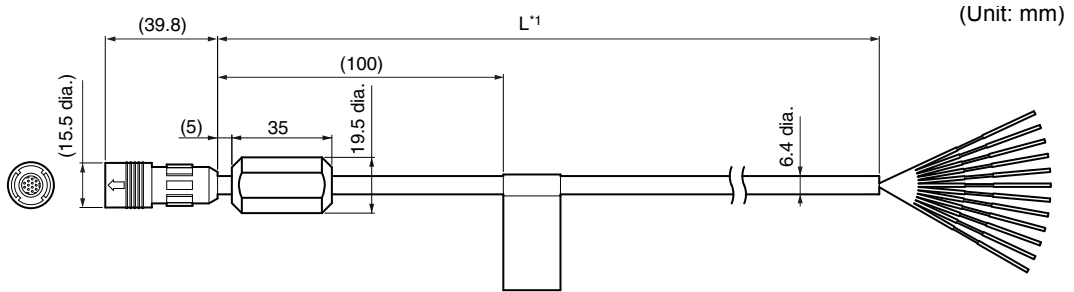

*1: The cable length is given in the following table.

Model	Cable length
FQ-WD002	2 m
FQ-WD005	5 m

FQ-WD010/WD020

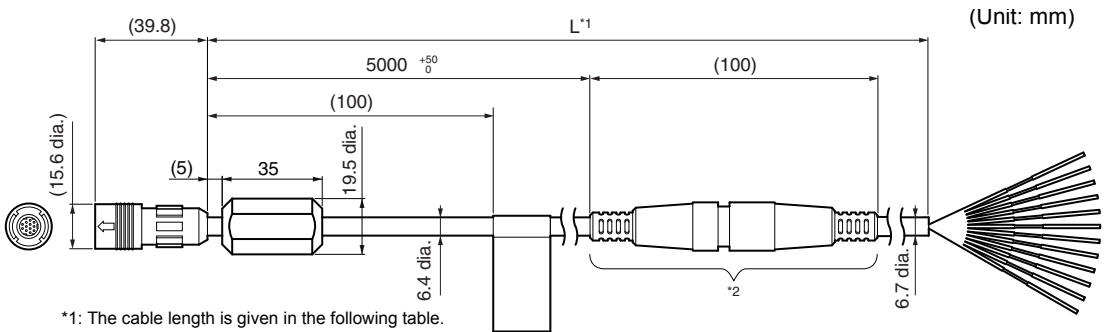

*1: The cable length is given in the following table.

Model	Cable length
FQ-WD010	10 m
FQ-WD020	20 m

*2: The relay connector does not have water-proofing.

• **FQ Ethernet Cable**

FQ-WN002/WN005/WN010/WN020

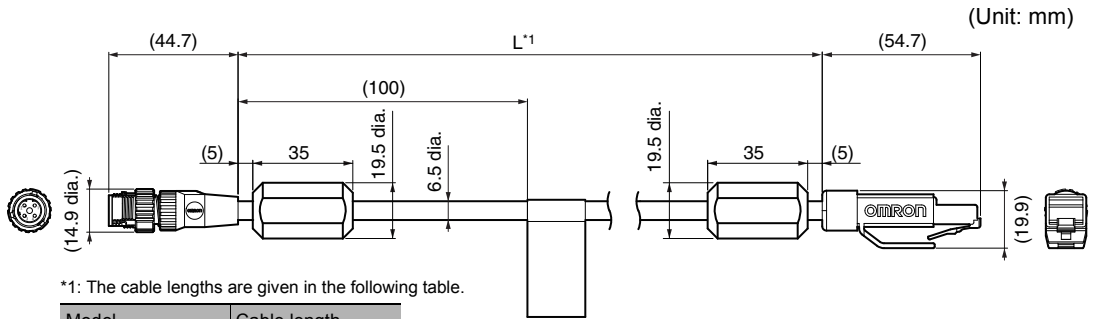

*1: The cable lengths are given in the following table.

Model	Cable length
FQ-WN002	2 m
FQ-WN005	5 m
FQ-WN010	10 m
FQ-WN020	20 m

• **Ethernet CableSensor Data Unit Cable**

FQ-WU002/WU005/WU010/WU020

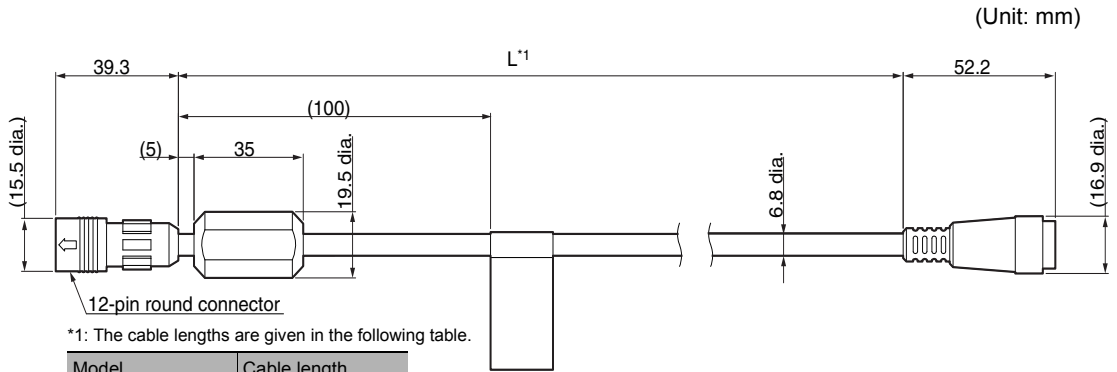

*1: The cable lengths are given in the following table.

Model	Cable length
FQ-WU002	2 m
FQ-WU005	5 m
FQ-WU010	10 m
FQ-WU020	20 m

• **Parallel Cable for FQ-SDU1**

FQ-VP1002/VP1005/VP1010

(Unit: mm)

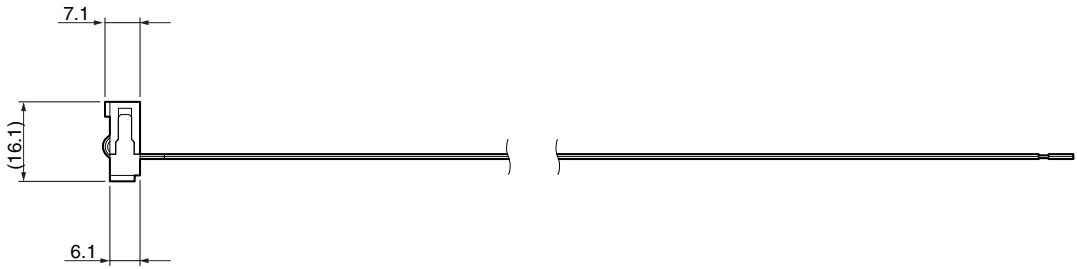
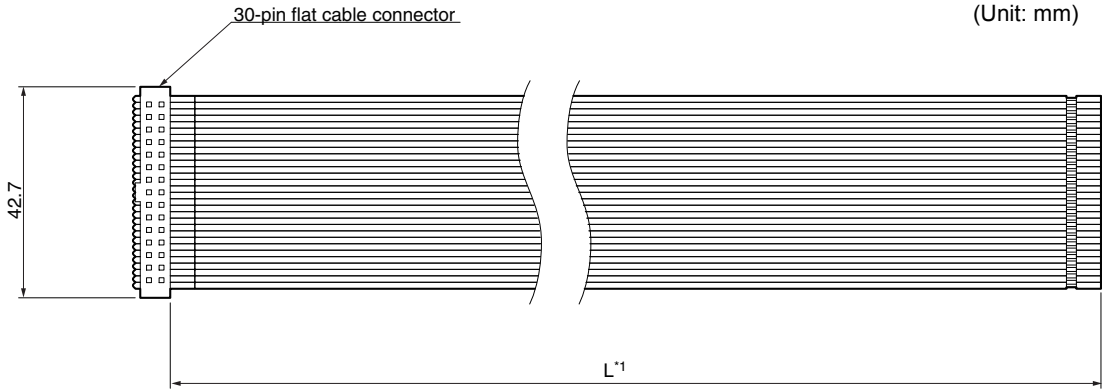

*1: The cable lengths are given in the following table.

Model	Cable length
FQ-VP1002	2 m
FQ-VP1005	5 m
FQ-VP1010	10 m

• **Parallel Cable for FQ-SDU2**

FQ-VP2002/VP2005/VP2010

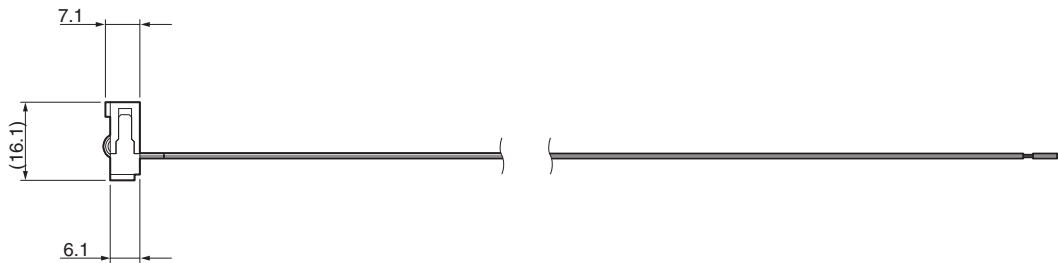
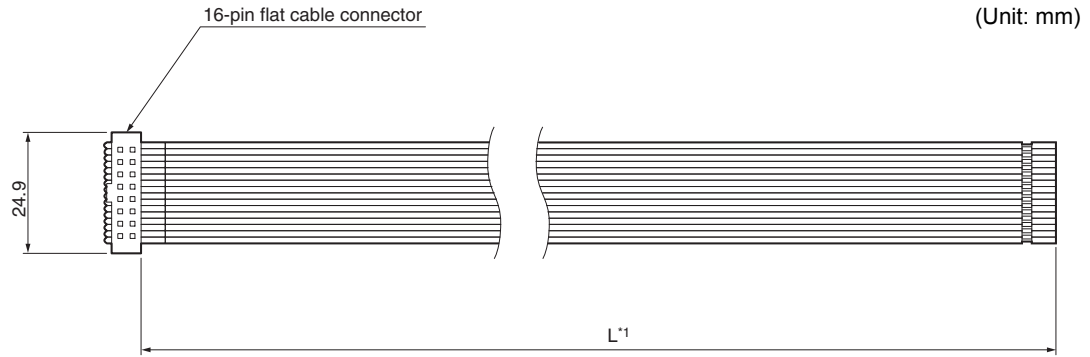

*1: The cable lengths are given in the following table.

Model	Cable length
FQ-VP2002	2 m
FQ-VP2005	5 m
FQ-VP2010	10 m

• **AC Adapter**

FQ-AC1

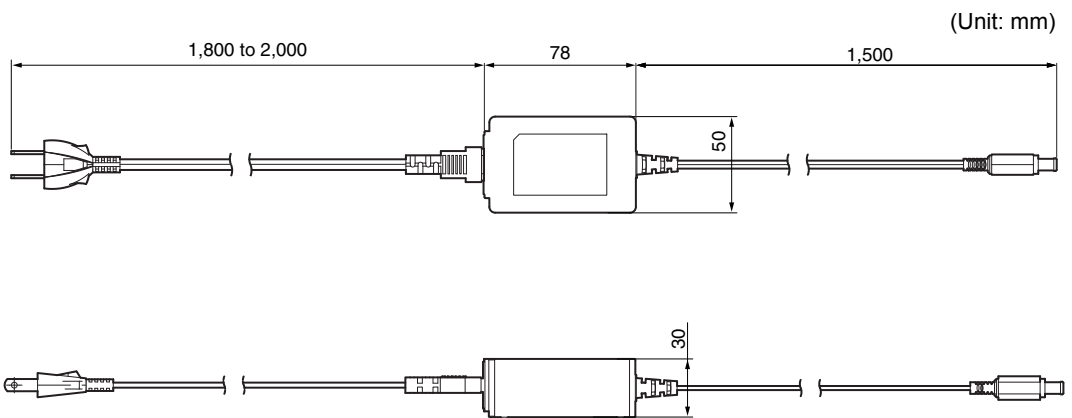

9-4 Updating the Software

FQ2-S1

FQ2-S2

FQ2-S3

FQ2-S4

FQ2-CH

The most recent version of the software and PC Tool can be downloaded from the following website for OMRON members. Refer to the *Member Registration Sheet* that is enclosed with the Sensor.

http://www.omron-cxone.com/vison_sys

After you download the software, use the following procedure to update.

When you update the software, always update the software for the Touch Finder or PC Tool first, and then update the software for the Sensor.

Step 1 Update the software for the PC Tool or Touch Finder.

- Update the PC Tool

Install the PC Tool that was downloaded.

- Update the software for the Touch Finder

- 1** Place the update file that you obtained directly in the root folder of an SD card.
- 2** Insert the SD card into the Touch Finder.
- 3** Press  (Setup Mode or Run Mode) – [TF settings] – [Update].

Step 2 Update the software for the Sensor.

- Updating from the PC Tool

- 1** Store the update file you obtained in the following directory.
\\....\My Documents\OMRON FQ\SDCard\UPDATE\SENSOR
- 2** To update the software in the Sensor, press  (Setup Mode) – [Sensor settings] – [Update].

- Updating from the Touch Finder

- 1** Place the update file that you obtained directly in the root folder of the SD card.
- 2** Insert an SD card into the Touch Finder.
- 3** To update the software in the Sensor, press  (Setup Mode) – [Sensor settings] – [Update].

The software will be updated automatically.

Important

Do not turn OFF the power supply until updating the software has been completed.

The Sensor or Touch Finder may not start normally if power is turned OFF during the update.

9-5 Connecting a Previous Touch Finder (FQ-D30/D31) to the FQ2-S Sensor

FQ2-S1

FQ2-S2

FQ2-S3

FQ2-S4

If you update the previous FQ-D30/D31 Touch Finder to version 1.6 or higher, you can connect it to an FQ2-S Sensor. However, the memory size that is required to use all of the filter items, position compensation items, and inspection items exceeds the memory capacity of the previous FQ-D30/D31 Touch Finder, so you will not be able to use all of the filter items, position compensation items, and inspection items that are provided in the FQ2-S Sensor.

Therefore, it is necessary to select only the filter items, position compensation items, and inspection items that you need to use and register them in the Sensor.

If you connect the Touch Finder without doing this, the Touch Finder may freeze as soon as it is connected or during operation.

Apart from the filter items, position compensation items, and inspection items, you can use all of the functions of the Sensor.

Download the update file for the Touch Finder (version 1.6 or higher) and the FQ Item Selector from the member website, and then use the following procedures to update the Touch Finder and register the filter items, position compensation items, and inspection items in the Sensor.

http://www.omron-cxone.com/vision_sys

• Updating the Touch Finder

- 1 Place the update file directly in the root folder of an SD card.**
- 2 Insert the SD card into the Touch Finder.**
- 3 Press  (Setup Mode or Run Mode) – [TF settings] – [Update].**
The Touch Finder will be updated automatically.

Important

Do not turn OFF the power supply until updating the Touch Finder has been completed.

The Touch Finder may not start normally if power is turned OFF during the update.

- Re-registering Inspection Items, Filter Items, and Position Compensation Items in the Sensor

Re-register the inspection items, filter items, and position compensation items in the Sensor using the FQ Item Selector. Unpack the FQ Item Selector file that you downloaded, execute the setup.exe file, and install the FQ Item Selector.

Important

Perform the following procedure without starting the PC Tool for FQ. If you start the PC Tool, Sensor detection and overwriting the file will not be performed normally.

- 1 Connect the Sensor to the PC.
- 2 Select [All Programs] – [OMRON] – [FQ] – [Tool] – [FQ Item Selector] from the Windows Start Menu to start the FQ Item Selector.
- 3 Select the language to display.
- 4 Select the models and versions of the Sensor and Touch Finder to be used.

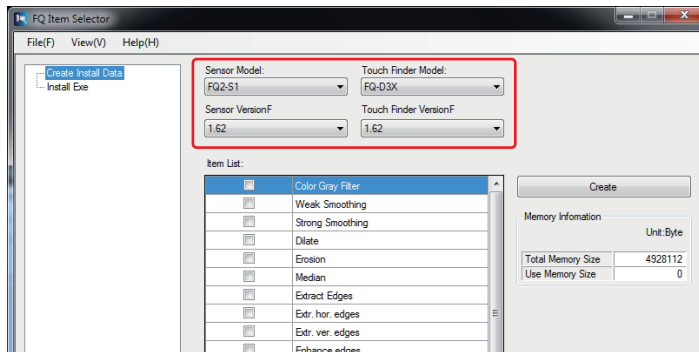

- 5 Select the inspection items to use.

The memory size that is required to use the selected inspection items will be displayed. You must select inspection items so that the total memory size of the Touch Finder is not exceeded.

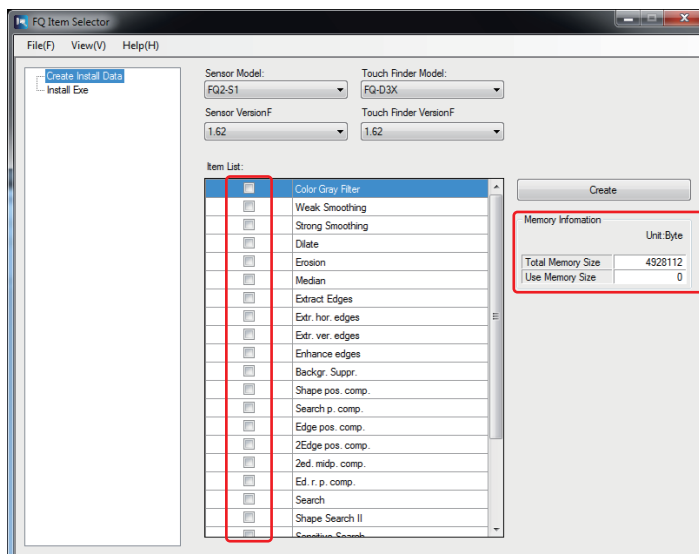

Note

Grayed-out Inspection Items

If selecting an inspection item would cause the total memory size to be exceeded, that inspection item will be grayed-out on the display. Select the inspection items with the highest priority first.

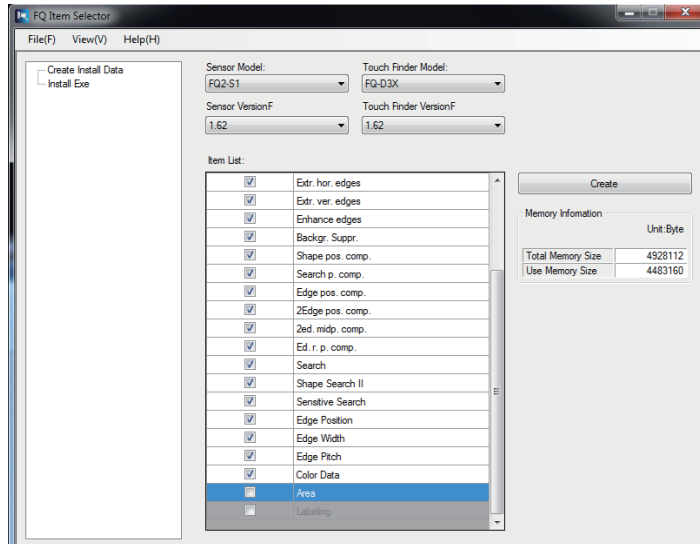

6 Click the [Create] Button to save the installation data.

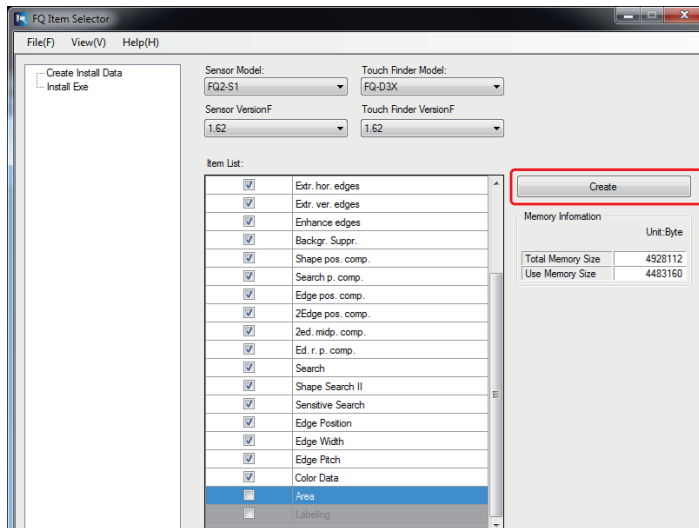

7 Click [Install Exe].

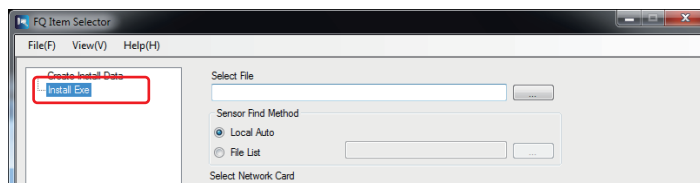

8 Select the Browse Button (...) and select the file that was saved in step 6, above.

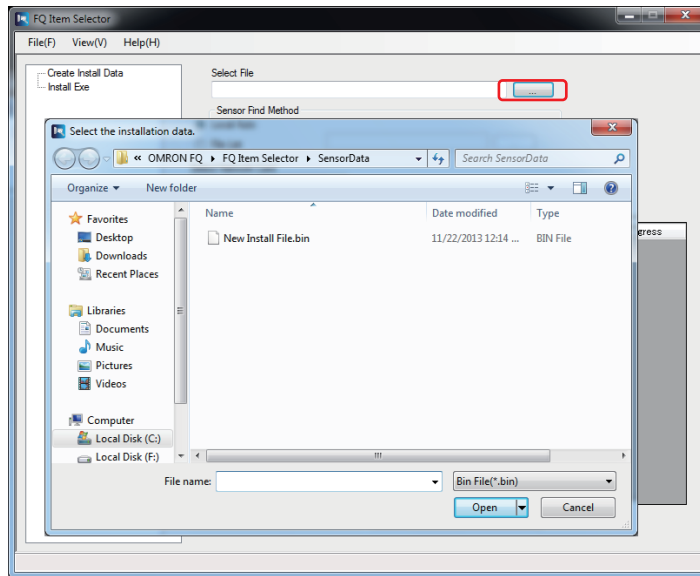

9 Set the Sensor Find Method parameter to [Local Auto].

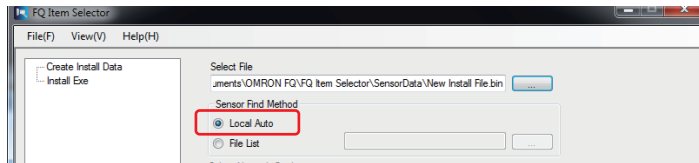

When a sensor cannot be detected automatically, or when connecting across routers, use the [File List] function. Sensors, whose IP addresses are listed in the file, can be detected with this function.

10 If there is more than one network card (NIC) installed in the PC, select the NIC that is connected to the Sensor.

More than one NIC will be displayed for a PC with a wireless LAN.

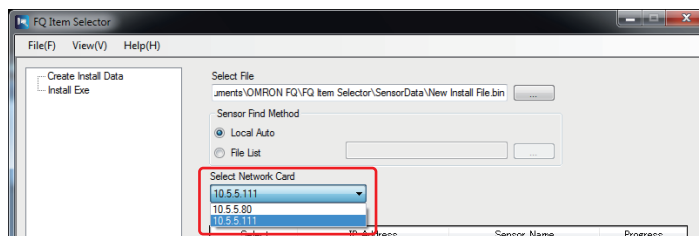

11 Click the [Update Sensor List] Button.

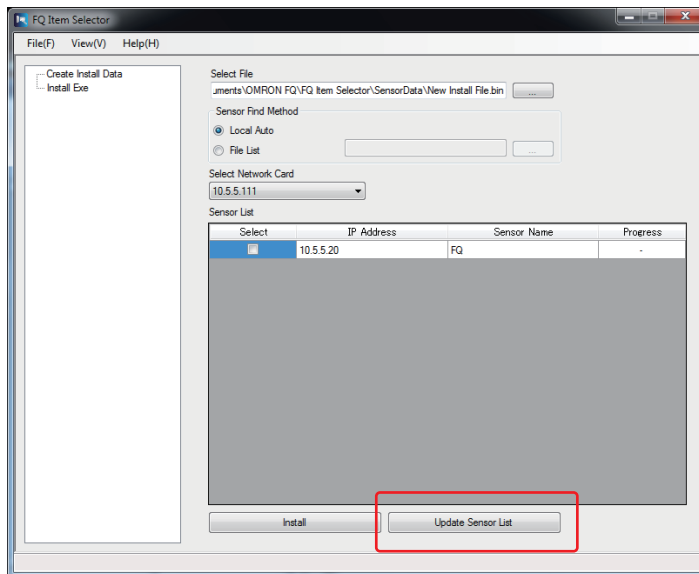

12 Select the Sensor from the list and click the [Install] Button.

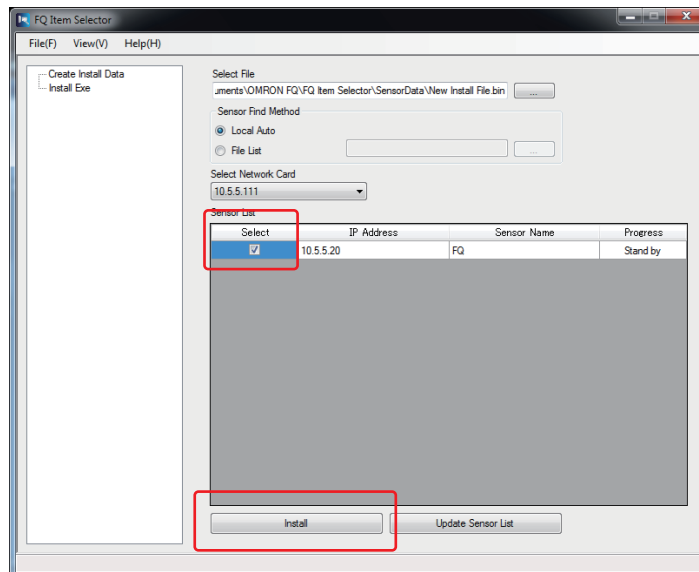

If *Installation completed normally* is displayed in the dialog box, the data has been overwritten normally.

13 Reset the Sensor.

• Restoring Inspection Items to the Sensor

It is not necessary to delete any inspection items to connect the FQ2-D30/D31 Touch Finder. To connect the FQ2-D30/D31 Touch Finder after performing the above operation, repeat the above operation, but select all of the inspection items in step 5 to re-register all of the inspection items in the original state.

MEMO

Index

<hr/>	
Numerics	
2D Codes (DPM)	201
2D-code	190
<hr/>	
A	
AC Adapter	568
AC power supply connector	
Touch Finder	37
ACK	57, 60
adjusting parameters	
adjustment in Run Mode	362
adjustment during operation	362
all color images	306, 315
All Region	356
All Sensor data	407
Angle	218, 234, 250, 263
Angle range	222, 238, 253, 266
Area	303, 313
area	300
Auto length	210
Average pitch	290
Average width	290
<hr/>	
B	
B average	297
Background Suppression	94
backing up data	406
backlight	384
Bar code	179
basic troubleshooting	435
Battery	65
specifications	561
binary images	306, 315
brightness	81, 295
brightness correction mode	78
Brightness step	424
BUSY	57, 60
<hr/>	
C	
calibration	369
calibration data	
saving	407
calibration group data	
saving	407
calibration pattern	371, 379
camera image	416
camera image file	382
Camera input	356
camera setup	76
capturing image	415
Cell	210
Cell Recog. Rate	519
changing line process using scenes	366
Character recognition	140
Characters	519
Check digit on/off	186
checking the error histories	433
clearing the error histories	433
<hr/>	
C-mount cover	36
C-mount lens mounting surface	36
Code color	210
Code type	210
Code type (2D-code)	197
Code type (Bar code)	186
color	
setting	278, 305, 314
color data	293
Color deviation	297
color difference	297
Color Gray Filter	93
Color ON/OFF	278
color palette	279, 306, 315
COMIN0	57, 60
COMIN1	57, 60
COMOUT	57
COMOUT0	60
COMOUT1	57
Composite codes on/off	186
configuration	138
connecting to more than one Sensor	386
connection	
automatic	29
connector cover	36
console	227
Contrast	519
Correlation	218, 234, 250, 263
correlation	215
Count	218, 234, 250
CSV	399
<hr/>	
D	
D. Area	303
D0 to D15	57
data	
saving	406
saving to file	406
DC power supply connector	
Touch Finder	37
decimal symbol	399
Decrement count	424
deleting log	403
Density average	297
Density deviat. (density deviation)	297
Density deviation	263
deviation area	303
Dilate	93
DIN Track mounting section	38
display elements	30
display language	427
display patterns	416
All color image	306, 315
Binary image	306, 315
Measurement image	306, 315
Selected color image	306, 315
display settings	306, 315

display types	354	Gravity X	303
displaying image data	421	Gravity Y	303
DSA	57	GUI	
<hr/>		language	427
E		H	
ECO mode	384	HDR function	83
edge level	276	hiding the menu	384
Edge pitch	290	high dynamic range	83
edge pitch	288	histograms	360
edge position	271	auto display	361
Edge position comp.		class	361
(edge position compensation)	102	display range	361, 395
edge position compensation	111	hue	295
edge rotation position compensation	122, 292	<hr/>	
edge width	282	I	
Edge width (edge in width)	284	I/O Cable	54
Enhance edges	93	connector	35, 36
Erosion	93	I/O Cables	567
ERROR	57, 60	I/O indicators	38
Error Correction Level	210	232C_COM	38
error histories	432	BUSY	38
error history		OR-NG	38
deleting	433	OR-OK	38
errors in error history	432	POWER/ERROR	38
viewing	433	RUN	38
error messages	434	SENSOR	38
errors stored in the error history	432	I/O monitor	385
Ethernet	67	image adjustment	91
Ethernet cable	567	image data	
connector	35	logging	394
Ethernet port		image input	
Touch Finder	37	increasing speed	343
exposure retry	424	partial input	343, 345
external lighting	77, 89	image input mode	345
Extract Edges	93	images	
Extract Horiz. Edges	93	displaying last NG image	383
Extract vertical edges	93	displaying saved images	382
<hr/>		frozen	381
F		live	380
Fast mode	210	updating	383
field separator	399	zooming in	380
file format	399	zooming out	380
files		zooming to fit display	380
logging	394	INO to IN5	60
filter items	93	INO to IN7	57
Focus	519	Increment count	424
focus	76	initializing	428
adjustment screw	76	Sensor and Touch Finder	428
formatting an SD Card	412	Input mode	462
FQ Ethernet Cable	570	inputs	
frame ground	56, 59	INO to IN5	54
frozen images	381	TRIG	54
<hr/>		inspection items	134
G		Area	300
G average	297	color palette	306, 315
Gain	80	Color Data	293
GATE	57	copying	139
Graphics	354	deleting	139
Graphics + Details	354	Edge Pitch	288
Gravity center X	313	Edge Position	272
Gravity center Y	313	color palette	279

teaching errors	281
Edge Width	282
teaching errors	287
labeling	310
renaming	139
Search	215, 230, 247, 259
teaching errors	229, 246, 258
searching	215, 230, 247, 259
installation	39
Interval	423
IP address	67, 70

J

judgements	
adjusting	347
auto adjustment	347
method	348

L

Labeling	310
language	427
LCD Backlight	384
lens models	43
Lens selection	42
live images	380
Log	382
logging	
deleting log	403
recent results	401
selecting data to be logged	396
settings	395
starting and stopping	399
Logging image file	382

M

MAC address	468, 472
macro rings	45
masking	226
Master angle	313
Max count	423
Max. pitch (maximum pitch)	290
Max. width (maximum pitch)	290
measurement data	
logging	392
measurement images	306, 315
measurement region	227, 256, 268
measurement time	342
Median	93
menus	
hiding	384
Min. pitch (minimum pitch)	290
Min. width (minimum pitch)	290
Model (model position compensation)	102
models	215
mounting	
control panel	48
DIN Track	47, 51, 52
mounting base	36, 41
Mounting Bracket	35
mounting holes	36
Multi-point output	220
mutual interference	

prevention	89
------------	----

N

noise level	277
normal retry	423
NPN	55, 62
Num. of char.	519
Number of labels	313

O

operation	351
operation indicators	36
BUSY	35, 36
CHARGE	37
ERROR	35, 36, 37
ETN	35, 36
OR	35, 36
POWER	37
SD ACCESS	37
Touch Finder	37
Vision Sensor	35
optical charts	39
optical diagrams	42
OR	57, 60
OR/NOT	226
Output end digit	520
Output starting digit	520
outputs	
BUSY	54
ERROR	54
OR	54
OUT0	54
OUT1	54
OUT2	54

P

Panel Mounting Adapter	48, 563
Parallel Cable for FQ-SDU1	571
Parallel Cable for FQ-SDU2	572
parallel I/O connector	38
password	413
PC Tool	33, 567
PNP	55, 62
Polarizing Filter	
using	84
Position compensation	356
position compensation items	102
Position X	218, 234, 250, 263, 274
Position Y	218, 234, 250, 263, 274
power supply and ground terminal block	38
power supply switch	
Touch Finder	37
preventing mutual interference of multiple Sensors	89

Q

QR Code Model	210
---------------	-----

R

R average	297
Record separator	399
RESET	57, 60

restarting	
Sensor and Touch Finder	428
Retry Function	422
Reverse	210
RS-232C connector	38
RUN	57, 60
<hr/>	
S	
saved images	
displaying	382
saving data	350, 406
saving image data	420
scene data	
saving	407
scene group data	
saving	407
scene retry	425
scenes	
changing	366
changing names	367
copying	367
deleting	367
SD card	
available space	411
formatting	412
information	411
operations	410
slot	37
SD card formatting	412
searching	
inspection items	215, 230, 247, 259
selected color images	306, 315
sensitive search	259
Sensor connector	38
Sensor data	
saving all Sensor data	407
Sensor Data Unit Cable	56, 59, 570
Sensor Data Units	38, 564
Sensor information	428
sensor monitor	355
Sensor selection	417
Sensor system data	
saving	407
Sensors	
single-function models	546
specifications	546
standard models	546
switching	74
Sensors with Built-in Lighting	35
Sensors with C-mounts	36
Set color	278, 305, 314
Setting the Retry Function	422
setting up Ethernet	67
Shape	210
Shape Search II	230, 247
shape search position compensation	104, 107
SHTOUT	57, 60
Shutter speed	80
Size	520
slider	38

sorting method	236, 251
source image	95
startup display	356, 357
startup mode	368
startup scene	368
startup setting	368
Statistical data	354
statistical data	
logging	404
STGOUT	57, 60
straps	50
Strong Smoothing	93
subnet mask	70
Sub-pixel	219
Switch Sensor	74
Switching Hub	33
system configuration	
	32, 74, 75, 76, 87, 91

<hr/>	
T	
takt time	342
teaching errors	
sensitive search	270
test measurements	
continuous test	340
performing	340
threshold	
average	348
maximum	348
minimum	348
time	
Touch Finder	427
Total label area	313
Touch Finder	560
information	428
model with AC/DC/battery	
power supply	560
model with DC power supply	560
time settings	427
Touch Finder data	
saving	407
trend monitor	
Auto display	359
Display range	359
Number of data	359
TRIG	57
TRIG0	60
trigger delay	88, 90
two Touch Finders connected	
at the same time	417
two-edge midpoint compensation	118
two-edge position compensation	114
<hr/>	
U	
updating	
software version	573
<hr/>	
V	
versions	428
<hr/>	
W	
Weak Smoothing	93
white balance	85

width amount	284
wiring	54
Sensor	52, 54
Sensor Data Units	56
Touch Finder	63
<hr/>	
Z	
zooming	380

Revision History

A manual revision code appears as a suffix to the catalog number at the bottom of the front and back covers of this manual.

Cat. No. Z337-E1-07

↑
Revision code

Revision code	Date	Revised contents
01	December 2013	Original production
02	July 2014	Corrected minor mistakes and added information on the numerical position compensation item.
03	April 2015	Corrected minor mistakes and added linear correction items, etc. (Supports sensor version 2.0)
04	August 2015	Additions corresponding to change of EN standard.
05	January 2016	Corrected minor mistakes and added information on the shape search III inspection item.(Supports sensor version 2.1)
06	November 2016	Corrected minor mistakes 2D-code inspection item specification change (sensor version 2.20) 2D-code (DPM) inspection item specification change (sensor version 2.20)
07	August 2017	Corrected minor mistakes

OMRON Corporation Industrial Automation Company
Kyoto, JAPAN

Contact: www.ia.omron.com

Regional Headquarters

OMRON EUROPE B.V.

Sensor Business Unit

Carl-Benz-Str. 4, D-71154 Nufringen, Germany
Tel: (49) 7032-811-0/Fax: (49) 7032-811-199

OMRON ELECTRONICS LLC

2895 Greenspoint Parkway, Suite 200
Hoffman Estates, IL 60169 U.S.A.
Tel: (1) 847-843-7900/Fax: (1) 847-843-7787

OMRON ASIA PACIFIC PTE. LTD.

No. 438A Alexandra Road # 05-05/08 (Lobby 2),
Alexandra Technopark,
Singapore 119967
Tel: (65) 6835-3011/Fax: (65) 6835-2711

OMRON (CHINA) CO., LTD.

Room 2211, Bank of China Tower,
200 Yin Cheng Zhong Road,
PuDong New Area, Shanghai, 200120, China
Tel: (86) 21-5037-2222/Fax: (86) 21-5037-2200

Authorized Distributor:

© OMRON Corporation 2013-2017 All Rights Reserved.
In the interest of product improvement,
specifications are subject to change without notice.

Cat. No. Z337-E1-07

0817