

## Vision Sensor

FH/FHV/FZ5 Series

# Vision System

## User's Manual

FH-1□□□/FH-1□□□-□□

FH-2□□□/FH-2□□□-□□

FH-3□□□/FH-3□□□-□□

FH-5□□□/FH-5□□□-□□

FH-L□□□/FH-L□□□-□□

FHV7□-□□□□

FZ5-6□□/FZ5-6□□-□□

FZ5-8□□/FZ5-8□□-□□

FZ5-11□□/FZ5-11□□-□□

FZ5-12□□/FZ5-12□□-□□

FZ5-L35□/FZ5-L35□-□□



## NOTE

- All rights reserved. No part of this publication may be reproduced, stored in a retrieval system, or transmitted, in any form, or by any means, mechanical, electronic, photocopying, recording, or otherwise, without the prior written permission of OMRON.
- No patent liability is assumed with respect to the use of the information contained herein. Moreover, because OMRON is constantly striving to improve its high-quality products, the information contained in this manual is subject to change without notice. Every precaution has been taken in the preparation of this manual. Nevertheless, OMRON assumes no responsibility for errors or omissions. Neither is any liability assumed for damages resulting from the use of the information contained in this publication.

## Trademarks

- Sysmac and SYSMAC are trademarks or registered trademarks of OMRON Corporation in Japan and other countries for OMRON factory automation products.
- This software is based in part on the work of the Independent JPEG Group.
- Microsoft, Windows, Windows Vista, Excel, and Visual Basic are either registered trademarks or trademarks of Microsoft Corporation in the United States and other countries.
- Intel, Core and Pentium are trademarks of Intel Corporation in the U.S. and/or other countries.
- EtherCAT® is registered trademark and patented technology, licensed by Beckhoff Automation GmbH, Germany.
- ODVA, CIP, CompoNet, DeviceNet, and EtherNet/IP are trademarks of ODVA.
- The SD, SDHC, microSD, and microSDHC logos are trademarks of SD-3C, LLC.  

- QR Code is a registered trademark of DENSO WAVE INCORPORATED.
- MELSEC is a registered trademarks of Mitsubishi Electric Corporation.

Other company names and product names in this document are the trademarks or registered trademarks of their respective companies.

## Copyrights

Microsoft product screen shots reprinted with permission from Microsoft Corporation.

# Introduction

---

Thank you for purchasing the FH/FHV/FZ5.

This manual provides information regarding functions, performance and operating methods that are required for using the FH/FHV/FZ5.

When using the FH/FHV/FZ5, be sure to observe the following:

- The FH/FHV/FZ5 must be operated by personnel knowledgeable in electrical engineering.
- To ensure correct use, please read this manual thoroughly to deepen your understanding of the product.
- Please keep this manual in a safe place so that it can be referred to whenever necessary.

# Related Manuals

The followings are the manuals related to this manual. Use these manuals for reference.

Name of Manual	Man.No.	Model	Proposes	Contents
Vision System FH Instruction Sheet	9607479-9	FH-1□□□ FH-1□□□-□□ FH-3□□□ FH-3□□□-□□	To confirm the safety and usage precautions of the Vision System FH series Sensor Controller.	Describes the definitions of basic terms, meaning of signal words, and precautions for correct use of FH series in the manual.
Vision System FH Instruction Sheet	3102269-4	FH-2□□□ FH-2□□□-□□ FH-5□□□ FH-5□□□-□□		
Vision System FH-L Instruction Sheet	9606631-1	FH-L□□□ FH-L□□□-□□	To confirm the safety and usage precautions of the Vision System FH-Lite series Sensor Controller.	Describes the definitions of basic terms, meaning of signal words, and precautions for correct use of FH-L series in the manual.
Vision System FZ5 Instruction Sheet	9524422-4	FZ5-6□□ FZ5-6□□-□□ FZ5-11□□ FZ5-11□□-□□	To confirm the setup procedures, safety and usage precautions of the Vision System FZ5-600, FZ5-1100 series Sensor Controller, including I/O setup and wiring	Describes the definitions of basic terms, meaning of signal words, and precautions for correct use of FZ5-600, FZ5-1100 series in the manual.
Vision System FZ5 Instruction Sheet	9308317-7	FZ5-8□□ FZ5-8□□-□□ FZ5-12□□ FZ5-12□□-□□	To confirm the setup procedures, safety and usage precautions of the Vision System FZ5-800, FZ5-1200 series Sensor Controller, including I/O setup and wiring	Describes the definitions of basic terms, meaning of signal words, and precautions for correct use of FZ5-800, FZ5-1200 series in the manual.
Vision System FZ5-L Instruction Sheet	9910002-2	FZ5-L35□ FZ5-L35□-□□	To confirm the setup procedures, safety and usage precautions of the Vision System FZ5-L Series Sensor Controller, including I/O setup and wiring.	Describes the definitions of basic terms, meaning of signal words, and precautions for correct use of FZ5-L series in the manual.
Smart Camera FHV Instruction Sheet	3129404-0	FHV7□-□□□□-C	To confirm the safety and usage precautions of the Smart Camera FHV series.	Describes the definitions of basic terms, the meaning of signal words, and precautions for correct use of FHV series in the manual.
Smart Camera Lighting Module FHV-LTM Instruction Sheet	3129276-4	FHV-LTM□□	To confirm the safety and usage precautions of the Smart camera lighting module FHV-LTM.	Describes the definitions of basic terms, the meaning of signal words, and precautions for correct use of the lighting module FHV-LTM in the manual.
Smart Camera Lens Module FHV-LEM-S Instruction Sheet	3128622-5	FHV-LEM-S□□	To confirm the safety and usage precautions of the Smart camera lens module FHV-LEM.	Describes the definitions of basic terms, the meaning of signal words, and precautions for correct use of the lens module FHV-LEM.
FHV Series Smart Camera Setup Manual	Z408	FHV7□-□□□□-C FHV7□-□□□□-S-□□ FHV7□-□□□□-S-□□-□□	When User want to know about the hardware specifications or to setup the Smart camera FHV series.	Describes FHV series specifications, dimensions, part names, I/O information, installation information, and wiring information.



Name of Manual	Man.No.	Model	Proposes	Contents
Vision System FH/FHV/FZ5 Series User's Manual	Z365	FH-1□□□ FH-1□□□-□□ FH-2□□□ FH-2□□□-□□	When User want to know how to setup the Sensor Controller of the Vision System FH/FZ5 series.	Describes the soft functions, setup, and operations to use Sensor Controller of the Vision System FH/FZ5 series.
Vision System FH/FZ5 series Processing Item Function Reference Manual	Z341	FH-3□□□ FH-3□□□-□□ FH-5□□□ FH-5□□□-□□ FH-L□□□ FH-L□□□-□□	When User confirm the details of each processing items at the create the measurement flow or operate it.	Describes the software functions, settings, and operations for using FH/FHV/FH5-series.
Vision System FH/FZ5 Series User's Manual for Communications Settings	Z342	FHV7□-□□□□-C FHV7□-□□□□-S-□□ FHV7□-□□□□-S-□□-□□  FZ5-L35□ FZ5-L35□-□□ FZ5-6□□ FZ5-6□□-□□ FZ5-8□□ FZ5-8□□-□□ FZ5-11□□ FZ5-11□□-□□ FZ5-12□□ FZ5-12□□-□□	When User confirm the setting of communication functions.	Describes the functions, settings, and communications methods for communicating between FH/FHV/FH5 series. The following communication protocol are described. Parallel, PLC Link, EtherNet/IP, EtherCAT, and Non-procedure
Vision System FH/FZ5 series Macro Customize Functions Programming Manual	Z367	FH-1□□□ FH-1□□□-□□ FH-2□□□ FH-2□□□-□□ FH-3□□□ FH-3□□□-□□	When User operate or programming using Macro Customize functions.	Describes the functions, settings, and operations for using Macro Customize function of the FH/FH5-series.
Vision System FH/FZ5 series Hardware Setup Manual	Z366	FH-5□□□ FH-5□□□-□□ FH-L□□□ FH-L□□□-□□  FZ5-L35□ FZ5-L35□-□□ FZ5-6□□ FZ5-6□□-□□ FZ5-8□□ FZ5-8□□-□□ FZ5-11□□ FZ5-11□□-□□ FZ5-12□□ FZ5-12□□-□□	When User want to know about the Hard-ware specifications or to setup the Sensor Controller of the Vision System FH/FZ5 series.	Describes FH/FZ5 series specifications, dimensions, part names, I/O information, installation information, and wiring information.
Vision System FH Series Operation Manual for Sysmac Studio	Z343	FH-1□□□ FH-1□□□-□□ FH-2□□□ FH-2□□□-□□ FH-3□□□ FH-3□□□-□□ FH-5□□□ FH-5□□□-□□	When User connect to NJ series via EtherCAT communication.	Describes the operating procedures for setting up and operating FH series Vision Sensors from the Sysmac Studio FH Tools.

# Manual Structure

## Page Structure

The following page structure and icons are used in this manual.

The diagram illustrates a page from a manual with various structural elements and their functions:

- Level 1 heading:** The top-most heading, "4 Installation and Wiring".
- Level 2 heading:** A sub-heading, "4-3 Mounting Units".
- Level 3 heading:** A further sub-heading, "4-3-1 Connecting Controller Components".
- Text:** The main body text describing the procedure for connecting units.
- A step in a procedure:** A numbered step, "1 Join the Units so that the connectors fit exactly.".
- Diagram:** A technical drawing showing the units being connected, with labels for "Hook", "Connector", and "Hook holes".
- Diagram:** A second technical drawing showing the units with sliders being moved, with labels for "Release", "Lock", and "Slider".
- Section-Header:** A section titled "Precautions for Correct Use" with a warning icon.
- Text:** The text under the precautions section: "The sliders on the tops and bottoms of the Power Supply Unit, CPU Unit, I/O Units, Special I/O Units, and CPU Bus Units must be completely locked (until they click into place) after connecting the adjacent Unit connectors."
- Page tab:** A small box containing the number "4", indicating the current page number.
- Page number:** The number "4-9" at the bottom right of the page.
- Manual name:** The text "NJ-series CPU Unit Hardware User's Manual (W500)" at the bottom left.
- Special information icons:** A set of four icons (a shield, a document, a list, and a checkmark) used to denote special information.

This illustration is provided only as a sample. It may not literally appear in this manual.

## Special Information

Special information in this manual is classified as follows:



### **Precautions for Safe Use**

---

Precautions on what to do and what not to do to ensure safe usage of the product.



### **Precautions for Correct Use**

---

Precautions on what to do and what not to do to ensure proper operation and performance.



### **Additional Information**

---

Additional information to read as required.

This information is provided to increase understanding or make operation easier.



### **Version Information**

---

Information on differences in specifications and functionality for CPU Units and EtherCAT Coupler Units with different unit versions and for different versions of the Sysmac Studio is given.

Note References are provided to more detailed or related information.

## Conventions Used in This Manual

- Use of Quotation Marks and Brackets

In this manual, menus and other items are indicated as follows.

[ ] Menu Indicates the menu names or processing items shown in the menu bar.

“ ” Item name Indicates the item names displayed on the screen.

# Definitions of Basic Terms

Term	Definition
FH Series	All FH series model names as follows: FH-1□□□, FH-1□□□-□□, FH-2□□□, FH-2□□□-□□, FH-3□□□, FH-3□□□-□□, FH-5□□□, FH-5□□□-□□, FH-L□□□, FH-L□□□-□□
FH-1000 series	All FH-1□□□ series model names as follows: FH-1□□□, FH-1□□□-□□
FH-2000 series	All FH-2□□□ series model names as follows: FH-2□□□, FH-2□□□-□□
FH-3000 series	All FH-3□□□ series model names as follows: FH-3□□□, FH-3□□□-□□
FH-5000 series	All FH-5□□□ series model names as follows: FH-5□□□, FH-5□□□-□□
FH-L series	All FH-L□□□ series model names as follows: FH-L□□□, FH-L□□□-□□
FZ5 series	All FZ series name shows the following: FZ5-6□□, FZ5-6□□-□□, FZ5-8□□, FZ5-8□□-□□, FZ5-11□□, FZ5-11□□-□□, FZ5-12□□, FZ5-12□□-□□, FZ5-L35□, FZ5-L35□-□□
FZ5-600 series	All FZ5-6□□series name the following: FZ5-6□□, FZ5-6□□-□□
FZ5-800 series	All FZ5-8□□series name the following: FZ5-8□□, FZ5-8□□-□□
FZ5-1100 series	All FZ5-11□□series name the following: FZ5-11□□, FZ5-11□□-□□
FZ5-1200 series	All FZ5-12□□series name the following: FZ5-12□□, FZ5-12□□-□□
FZ5-L series	All FZ5-L35□ series name the following: FZ5-L35□, FZ5-L35□-□□
Sensor Controller	It is a generic name of FH/FZ5 series. For FHV series, it has the same meaning as smart camera.
measurement flow (abbreviated as "flow")	A continuous flow of measurement processing. A measurement flow consists of a scene created from a combination of processing items.
measurement processing	Executing processing items for inspections and measurements.
Measurement ID	Information of time when the sensor controller receives the measurement trigger and the line no. Format of measurement ID: YYYY-MM-DD_HH-MM-SS-XXXX YYYY: Year (4 digits) MM: Month DD: Date HH: Hour MM: Minute SS: Second XXXX: Millisecond Example: Measured time: 12/24/2007, 11:10:25.500: Line: 0 Measurement ID: 2007-12-24_11-10-25-5000

Term	Definition
processing item	<p>Any of the individual items for vision inspections that are partitioned and packaged so that they can be flexibly combined.</p> <p>These include the Search, Position Compensation, and Fine Matching items.</p> <p>Processing items can be classified for image input ([Input image]), inspection/measurement ([Measurement]), image correction ([Compensate image]), inspection/measurement support ([Support measurement]), process branching ([Branch]), results external output ([Output result]), resulting image display ([Display result]), etc.</p> <p>You can freely classify processing items to handle a wide range of applications.</p> <p>A scene (i.e., a unit for changing the measurement flow) is created by registering the processing items as units.</p>
scene	<p>A unit for changing the measurement flow that consists of a combination of processing items.</p> <p>“Scene” is used because of the correspondence to the scene (i.e., type of measurement object and inspection contents) where measurements are performed.</p> <p>A scene is created for each measurement or measurement contents.</p> <p>You can easily achieve a changeover simply by changing the scene when the measurement object or inspection content changes.</p> <p>Normally you can set up to 128 scenes. If you need more than 128 scenes, you can separate them into different groups or use the Conversion Scene Group Data Tool to create a scene group that contains over 128 scenes.</p>
processing unit (abbreviated as “unit”)	<p>A processing item that is registered in a scene.</p> <p>Numbers are assigned to processing units in order from the top and they are executed in that order.</p> <p>Processing items are registered for the processing units to create a scene (i.e., a unit for changing the measurement flow).</p>
measurement trigger	<p>A trigger for executing measurements.</p> <p>With a parallel interface, the STEP signal or command 00 (Continuous Measurement) is used. With a serial interface, an Execute One Measurement or a Start Continuous Measurement command is used.</p>
test measurement	<p>A measurement that is performed to manually test (check) measurements under the conditions that are set in the currently displayed scene.</p> <p>Test measurements can be executed on an Adjustment Window. Processing is completed inside the Controller and the measurement results are not normally output on an external interface.</p> <p>However, you can select [Output] in [Test measurement] to output the measurement results after executing measurements.</p>
single measurement	<p>A measurement that is executed only once in synchronization with the trigger input.</p>
continuous measurement	<p>Measurements are executed repeatedly and automatically without a trigger input.</p>

Term		Definition
operation modes	Double Speed Multi-input	A mode that processes the measurement flow for the first trigger and then processes the measurement flow in parallel for the second trigger to achieve a high-speed trigger input interval. It is used together with the multi-input function.
	Multi-line Random-trigger	A trigger mode that allows you to independently processing multiple measurement flows. With traditional image processing, two or more triggers cannot be acknowledged at the same time. In Multi-line Random-trigger Mode, you can randomly input multiple triggers into one Controller to independently process multiple scenes in parallel.
	Non-stop Adjustment	A mode that allows you to adjust the flow and set parameters while performing measurements. The enables adjustments without stopping the line or stopping inspections.
	Standard	A logging mode that allows complete parallel processing of measurements and logging. Traditionally, logging was not possible while processing measurements. Either measurements or logging had to be given priority and the other one had to wait. With this mode, you can save the measurement images in external storage without affecting the transaction time.
parallel processing (an option for any of the above operation modes)	Parallel processing splits part of the measurement flow into two or more tasks, and processes each task in parallel to shorten the transaction time. Processing items for parallel processing are used so that the user can specify the required parallel processing.	
multi-input function	A function that is used to consecutively and quickly input images. It allows the next STEP signal to be acknowledged as soon as the image input processing is completed. There is no need to wait for measurement processing to be completed. You can check whether image input processing has been completed with the status of the READY signal. Even if the READY signal is ON when measurement processing is being executed, the next STEP signal can be acknowledged.	

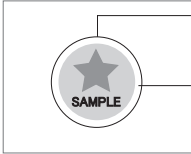
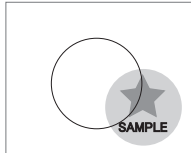
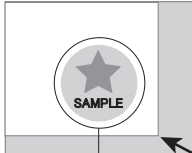
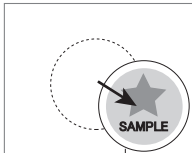
Term	Definition
Position compensation	<p>When the location and direction of measured objects are not fixed, the positional deviation between reference position and current position is calculated and measurement is performed after correcting.</p> <p>Please select processing items that are appropriate to the measurement object from processing items that are related to position compensation.</p> <ul style="list-style-type: none"> <li>●Reference position Measurement area and objects to be measured are correctly aligned.</li> </ul>  <ul style="list-style-type: none"> <li>●When position of object to be measured is deflected Object to be measured overflows Measurement area.</li> </ul>  <p>When position deflection correction is set in advance:</p> <div style="display: flex; justify-content: space-around;"> <div style="width: 45%;"> <p>Measurement will be carried out after moving the image for a corresponding deflection and returning to the reference position.</p>  </div> <div style="width: 45%;"> <p>Measurement will be carried out after moving the Measurement area for a corresponding deflection.</p>  </div> </div> <p>Measurement will be carried out after measured object enters into Measurement area.</p>
Reference position	The point that is always the reference. If the location of the registered model is different from the reference position, the setting should be changed in [Ref. setting].
Model	The image pattern that serves as the inspection target. Characteristics portions are extracted from images of the object and registered as model registration.



Term	Definition
2's complement	<p>Binary numbers are generally used to represent negative numbers.</p> <p>Negative numbers are expressed by "Inverting all bits of a positive number and adding 1 to the result".</p> <p>(Example) "-1" is expressed as 2's complement            "-1" can be calculated by "0-1".</p> <p>(In the case of 1, minus 1)</p> $\begin{array}{r} \downarrow \\ \square 00000000 (= 0) \\ -) 00000001 (= 1) \\ \hline 11111111 (= -1) \end{array} \leftarrow \text{"-1" is expressed with 2's Complement (for 8 bits)}$ <p>There are methods for simple calculation without performing this kind of computation.            For instance, "Negative number = inverting all bits of a positive number and then adding 1 to the result".</p> $\begin{array}{l} 00000001 (= 1) \\ \downarrow \text{Invert all bits} \\ 11111110 \\ \downarrow \text{Plus 1} \\ \boxed{11111111} (= -1) \end{array}$ <p>The first digit is used to judge whether the number is positive or negative.            When 0: Positive number (or 0)            When 1: Negative number</p> <p>The advantage of two's complement numbers is that positive and negative numbers can be used as is in calculations.</p> <p>(Example) When <math>-1+10=9</math></p> $\begin{array}{r} 11111111 (= -1) \\ +) 00001010 (= 10) \\ \hline 00001001 (= 9) \end{array}$



# Sections in this Manual

<b>1</b>	<b>Overview</b>	<b>9</b>	<b>Saving/ Loading Data</b>	<b>1</b>	<b>9</b>
<b>2</b>	<b>Features</b>	<b>10</b>	<b>Advanced Usage</b>	<b>2</b>	<b>10</b>
<b>3</b>	<b>Basic Operations</b>	<b>11</b>	<b>What to Do!</b>	<b>3</b>	<b>11</b>
<b>4</b>	<b>Using Tools</b>	<b>A</b>	<b>Appendices</b>	<b>4</b>	<b>A</b>
<b>5</b>	<b>Creating Measurement Scenes</b>	<b>I</b>	<b>Index</b>	<b>5</b>	<b>I</b>
<b>6</b>	<b>Performing Measurement and Adjustment</b>			<b>6</b>	
<b>7</b>	<b>Increasing/Switching Measurement Scenes</b>			<b>7</b>	
<b>8</b>	<b>Setting Windows</b>			<b>8</b>	

# CONTENTS

---

<b>Introduction .....</b>	<b>1</b>
<b>Related Manuals .....</b>	<b>2</b>
<b>Manual Structure .....</b>	<b>4</b>
Page Structure .....	4
Special Information .....	5
Conventions Used in This Manual .....	6
<b>Definitions of Basic Terms .....</b>	<b>7</b>
<b>Sections in this Manual .....</b>	<b>13</b>
<b>CONTENTS .....</b>	<b>14</b>
<b>Terms and Conditions Agreement .....</b>	<b>22</b>
Warranty, Limitations of Liability .....	22
<b>Safety Precautions .....</b>	<b>24</b>
<b>Precautions for Safe Use .....</b>	<b>26</b>
<b>Precautions for Correct Use .....</b>	<b>31</b>
<b>Regulations and Standards .....</b>	<b>37</b>
All Series .....	37
FH-1000/2000/3000/5000 series .....	37
FH-L series .....	38
FHV series .....	39
FZ5 series/FZ5-L series .....	39
<b>Revision History .....</b>	<b>40</b>

## Section 1      Overview

---

<b>1-1    Checking the System Configuration .....</b>	<b>1-2</b>
1-1-1    System Configuration .....	1-2
1-1-2    Functional Comparison between the FH-series, FHV-series and FZ5-series Controllers .....	1-3
<b>1-2    Flow of Application .....</b>	<b>1-7</b>

## Section 2      Features

---

<b>2-1    Basic Mechanism for Measurements .....</b>	<b>2-2</b>
<b>2-2    Support for a Variety of Scenes and Measurement Lines .....</b>	<b>2-4</b>

## Section 3      Basic Operations

---

<b>3-1    Preparing the Controller and Cameras .....</b>	<b>3-2</b>
3-1-1    Camera Setup .....	3-2
3-1-2    Preparing a Controller .....	3-4
3-1-3    Adjusting the Camera .....	3-5

<b>3-2 Basic Knowledge about Operations .....</b>	<b>3-6</b>
3-2-1 Inputting Values .....	3-6
3-2-2 Inputting Text .....	3-7
3-2-3 Selecting Files and Folders .....	3-10
3-2-4 Available Operations in Select File Window .....	3-13
3-2-5 Using the Zoom Function.....	3-14
3-2-6 Setting Figures.....	3-15
3-2-7 Changing the Image Mode and Other Display Contents .....	3-24
3-2-8 Changing the Display Ratio .....	3-25
<b>3-3 Checking System Information.....</b>	<b>3-27</b>
<b>3-4 Checking the Memory Consumption and Percentage of Memory Used .....</b>	<b>3-31</b>
<b>3-5 Capturing Screen Images .....</b>	<b>3-32</b>
<b>3-6 Saving Settings before Turning OFF the Power and Restarting .....</b>	<b>3-34</b>
3-6-1 Saving the Setting to the Controller [Data Save] .....	3-34
3-6-2 Device Information Storage Tool.....	3-35
3-6-3 Restarting the Controller: [System Restart] .....	3-37
<b>3-7 Initializing the Controller .....</b>	<b>3-39</b>
<b>3-8 Turning OFF the LCD .....</b>	<b>3-41</b>
3-8-1 Turning OFF the LCD [LCD OFF].....	3-41
3-8-2 Restoring Power to the LCD .....	3-41

## Section 4 Setting the Controller

---

<b>4-1 Selecting Language [Startup Settings].....</b>	<b>4-2</b>
<b>4-2 Setting the Status at Startup [Startup Settings].....</b>	<b>4-3</b>
<b>4-3 Setting Communication [Startup Settings] .....</b>	<b>4-6</b>
<b>4-4 Setting Operation Mode [Startup Settings] .....</b>	<b>4-12</b>
4-4-1 Setting the Operation Mode.....	4-13
4-4-2 Parallel Processing.....	4-29
<b>4-5 Checking the Camera Connections: [Camera Connection] .....</b>	<b>4-39</b>
<b>4-6 Setting the Trigger Delay [Inter-camera Setting] .....</b>	<b>4-40</b>
<b>4-7 Setting the SHTOUT Signal [Output Signal Settings] .....</b>	<b>4-43</b>
<b>4-8 Setting the Conditions Related to Communications.....</b>	<b>4-46</b>
<b>4-9 Setting Date/Time [Date/Time Settings].....</b>	<b>4-47</b>
<b>4-10 Setting Fan Control [Fan Control Setting] .....</b>	<b>4-49</b>
<b>4-11 Setting the Pulse Width for the STEP Input Detection [STEP Signal Filter Setting] .....</b>	<b>4-50</b>
<b>4-12 Setting Encoder Trigger [Encoder Trigger Setting].....</b>	<b>4-51</b>
<b>4-13 Setting Network Drive [Network Drive Setting] .....</b>	<b>4-53</b>
<b>4-14 Setting Screen Capture [Screen Capture Setting].....</b>	<b>4-57</b>
<b>4-15 Setting the Conditions that are Related to Operation during Measurement [Measurement Conditions] .....</b>	<b>4-58</b>
<b>4-16 Setting Logging Conditions [Logging Setting].....</b>	<b>4-60</b>
<b>4-17 Setting Operation Log [Operation Log Setting].....</b>	<b>4-61</b>
<b>4-18 Setting the Operation at Error [Error Operation Setting].....</b>	<b>4-62</b>
<b>4-19 Setting Character Code using Macro/Variable Function [Macro/Variable Function Setting] .....</b>	<b>4-64</b>

## Section 5 Creating Measurement Scenes

<b>5-1</b>	<b>What Is a Scene?</b> .....	<b>5-2</b>
<b>5-2</b>	<b>Creating a Scene</b> .....	<b>5-5</b>
<b>5-3</b>	<b>Editing Processing Units in Scenes</b> .....	<b>5-7</b>
<b>5-4</b>	<b>Displaying and Checking Processing Branches in a Scene</b> .....	<b>5-10</b>
<b>5-5</b>	<b>Using Variables to Edit the Flow [TDM Editor]</b> .....	<b>5-14</b>
5-5-1	Edit Flow Screen .....	5-14
5-5-2	Editing Processing Units in a Scene .....	5-24
5-5-3	Editing Scenes .....	5-34
5-5-4	Using Variables .....	5-43

## Section 6 Performing Measurement and Adjustment

<b>6-1</b>	<b>Executing Test Measurements</b> .....	<b>6-3</b>
<b>6-2</b>	<b>Key Points for Adjustment</b> .....	<b>6-5</b>
6-2-1	Stabilizing Measurements .....	6-5
6-2-2	Shortening Processing Time .....	6-7
<b>6-3</b>	<b>Useful Functions for Operation</b> .....	<b>6-8</b>
6-3-1	Logging Measurement Values and Measurement Images [Data Logging/Image Logging].....	6-8
6-3-2	Saving Data to an External Device [FTP/Network Drive] .....	6-24
<b>6-4</b>	<b>Useful Functions for Operation</b> .....	<b>6-27</b>
6-4-1	Remeasuring Saved Images [Remeasurement] .....	6-27
6-4-2	Improving Adjustment Efficiency [Judgement Result Monitoring] .....	6-28
<b>6-5</b>	<b>Analyzing Inspection and Measurement Results [NG Analyzer]</b> .....	<b>6-29</b>
6-5-1	Layout of NG Analyzer Window .....	6-30
6-5-2	Using Method of NG Analyzer.....	6-33
6-5-3	Saving Measurement Values .....	6-35
6-5-4	Changing Judgement Conditions without Stopping Measurement [Simplified Non-stop Adjustment] .....	6-35
6-5-5	Changing Regions as a Batch [Shift area] .....	6-37
<b>6-6</b>	<b>Updating the Reference Position Data for a Unit in the Measurement Flow [Update Standard Position Tool]</b> .....	<b>6-38</b>
6-6-1	Monitoring Measurement Value Trends [Trend monitor] .....	6-39
6-6-2	Clearing Measurement Results [Measurement Clear] .....	6-41
6-6-3	Clearing Saved Images [Logging Image Clear] .....	6-41
<b>6-7</b>	<b>Managing Images used for Model Registration and Reference [Registered Image Manager]</b> .....	<b>6-42</b>
6-7-1	Specifying the Destination to Save .....	6-42
6-7-2	Registering Images .....	6-44
6-7-3	Renaming Image Names .....	6-45
6-7-4	Deleting Images .....	6-46
6-7-5	Loading Images.....	6-46
<b>6-8</b>	<b>Verifying Calibration Results [Calibration Support Tool]</b> .....	<b>6-47</b>
6-8-1	Data Setting .....	6-47

## Section 7 Increasing/Switching Measurement Scenes

<b>7-1</b>	<b>What Is a Scene Group?</b> .....	<b>7-2</b>
<b>7-2</b>	<b>Switching the Scene or Scene Group</b> .....	<b>7-4</b>
7-2-1	Switching the Scene.....	7-4
7-2-2	Switching Scene Groups.....	7-4

<b>7-3</b>	<b>Editing Scenes [Scene Maintenance]</b> .....	<b>7-6</b>
7-3-1	Copying Scenes.....	7-6
7-3-2	Deleting Scenes.....	7-6
7-3-3	Renaming a Scene and Adding a Description .....	7-7
<b>7-4</b>	<b>Editing Scene Groups [Scene Maintenance]</b> .....	<b>7-8</b>
7-4-1	Copying and Deleting Scene Groups .....	7-8
7-4-2	Renaming the Scene Group Name.....	7-9
<b>7-5</b>	<b>Saving Scene Groups in External Storage [Scene Group Saving Destination Settings]</b> .....	<b>7-10</b>
<b>7-6</b>	<b>Increasing the Number of Scenes in a Group to more than 128 Scenes [Conversion Scene Group Data Tool]</b> .....	<b>7-12</b>

## Section 8      Setting Windows

<b>8-1</b>	<b>Windows</b> .....	<b>8-3</b>
8-1-1	Types of Windows.....	8-3
8-1-2	Overview of Window Navigation .....	8-4
8-1-3	Main Window (Layout 0): Adjustment Window (Default) .....	8-5
8-1-4	Main Window (Layout 1): Run Window (Default).....	8-10
<b>8-2</b>	<b>Adjustment Windows and Run Windows</b> .....	<b>8-11</b>
8-2-1	Main Window (Layout 0): Adjustment Window (Default) .....	8-11
8-2-2	Main Window (Layout 1): Run Window (Default).....	8-12
8-2-3	Main Window (Layout 1): Switching to the Run Window .....	8-12
8-2-4	Main Window (Layout 1): Switching to the Adjustment Window .....	8-13
<b>8-3</b>	<b>Arranging Windows [Layout Functions]</b> 8-14	
8-3-1	Arranging Window Elements (Layout Modification) .....	8-14
8-3-2	Setting the Behavior of Output Signals for Each Layout [Layout Settings].....	8-25
8-3-3	Switching Layout Numbers in the Main Window [Layout Switching] .....	8-26
8-3-4	Judgement Pane.....	8-27
8-3-5	Information Pane .....	8-27
8-3-6	Toolbox Pane .....	8-28
8-3-7	Measurement Pane .....	8-30
8-3-8	Flow Display Pane .....	8-30
8-3-9	Detail Result Pane .....	8-31
8-3-10	Image Container Pane.....	8-32
8-3-11	Error Pane .....	8-35
8-3-12	Image File Display Pane.....	8-37
8-3-13	Label Pane .....	8-39
8-3-14	Extended Window Parts .....	8-40
8-3-15	Data Grid Window (MDI_DataGrid.dll).....	8-41
8-3-16	Login Account Display Window (MDI_DisLoginUser.dll) .....	8-47
8-3-17	Setting Dialog Box Display Button Window (MDI_DisSetupBtn.dll).....	8-48
8-3-18	Text Display Window (MDI_DispText.dll) .....	8-51
8-3-19	Custom Dialog Display Button Window (MDI_ExecuteBtn.dll) .....	8-53
8-3-20	Macro Trigger Window (MDI_McrTrigger.dll) .....	8-56
8-3-21	Message Box Display Window (MDI_MsgBox.dll).....	8-57
8-3-22	Value Input Window (MDI_NumBox.dll).....	8-58
8-3-23	Data Settings Button Window (MDI_SetDataBtn.dll).....	8-60
8-3-24	Simple Data Grid Window (MDI_SimpleDataGrid.dll).....	8-63
8-3-25	Troubleshooting .....	8-66
<b>8-4</b>	<b>Creating a Custom Dialog Box [Custom Dialog Functions]</b> 8-67	
8-4-1	Flow of Use.....	8-67
8-4-2	Custom Dialog Tool.....	8-68
8-4-3	Launching Your Custom Dialog Box .....	8-86

## Section 9 Saving/Loading Data

<b>9-1</b>	<b>Saving Data to the FH series/FZ5 series</b> .....	<b>9-3</b>
9-1-1	About Saving Areas .....	9-3
9-1-2	External Drive Names .....	9-5
9-1-3	Using External Storage Devices .....	9-6
9-1-4	Shared Folder on a Computer Connected to the Network .....	9-6
<b>9-2</b>	<b>Saving Settings Data to the Flash Memory</b> .....	<b>9-7</b>
<b>9-3</b>	<b>Saving Setting Data to the Controller RAMDisk or an External Storage Device</b> .....	<b>9-8</b>
<b>9-4</b>	<b>Saving Logged Images in the Controller Memory (RAM) to a RAMDisk or an External Storage Device</b> .....	<b>9-10</b>
<b>9-5</b>	<b>Copying or Moving Files between the Controller RAMDisk and an External Storage Device</b> .....	<b>9-12</b>
<b>9-6</b>	<b>Loading Settings Data from the Controller RAMDisk or an External Storage Device to the Sensor Controller</b> .....	<b>9-13</b>
<b>9-7</b>	<b>Backing up Sensor Controller Setting Data [Configuration Copy]</b> .....	<b>9-15</b>
9-7-1	Before Backing up .....	9-15
9-7-2	Backing up Sensor Controller Settings .....	9-17
9-7-3	Restoring Saved Settings .....	9-27
9-7-4	Troubleshooting .....	9-30
<b>9-8</b>	<b>Copying Settings for Each Line in Multi-line Random-trigger Mode [Line Maintenance]</b> .....	<b>9-32</b>
9-8-1	Before use of Line Maintenance .....	9-33
9-8-2	Line Maintenance tool operations .....	9-36
9-8-3	Operating with Functional Limitations .....	9-44
9-8-4	Troubleshooting .....	9-47
<b>9-9</b>	<b>Saving Image Files to a RAMDisk or an External Storage Device [Image File Save]</b> ....	<b>9-48</b>
<b>9-10</b>	<b>Outputting a list of Scene Data Setting Values [Setting Values Download/Upload Tools]</b> .....	<b>9-51</b>
9-10-1	Downloading Setting Values .....	9-51
9-10-2	About Downloaded CSV Files .....	9-52
9-10-3	Uploading Setting Values .....	9-53
<b>9-11</b>	<b>Saving/Loading Layout Settings [Layout Upload, Download Tool]</b> .....	<b>9-55</b>

## Section 10 Advanced Usage

<b>10-1</b>	<b>Remotely Operating the Controller [Remote Operation]</b> .....	<b>10-3</b>
10-1-1	Environment Settings .....	10-5
10-1-2	Connection Method for Remote Operation .....	10-10
10-1-3	Terminating Remote Operation .....	10-13
10-1-4	Differences from Local Operation and Limitations .....	10-14
<b>10-2</b>	<b>Multi-trigger Imaging Processing with Any Timing [Multi-trigger Imaging]</b> .....	<b>10-15</b>
10-2-1	Settings for Multi-trigger Imaging .....	10-16
10-2-2	Restrictions .....	10-17
10-2-3	Setting Methods .....	10-19
10-2-4	About Multi-input Function (Multi-trigger Imaging) .....	10-23
10-2-5	Troubleshooting .....	10-28
<b>10-3</b>	<b>Limiting User Operations [Security Settings]</b> .....	<b>10-29</b>
10-3-1	Setting Accounts (Account List) .....	10-29
10-3-2	Setting Layout Restrictions .....	10-33
10-3-3	Setting User Group Operation Restrictions .....	10-34
10-3-4	Saving/Loading/Deleting the Security Settings .....	10-36
<b>10-4</b>	<b>Recording the Operation History [Operation Log]</b> .....	<b>10-40</b>
10-4-1	Using the Operation Log .....	10-40
10-4-2	Operation Log Format .....	10-43



<b>10-5</b>	<b>Setting the Keyboard Layout for the Controller [Keyboard Layout Selection Tool] ...</b>	<b>10-44</b>
<b>10-6</b>	<b>Switching User Accounts .....</b>	<b>10-45</b>
10-6-1	Logging in .....	10-45
10-6-2	Logging out .....	10-46
<b>10-7</b>	<b>Customizing Communication Commands [Communication Command Macro] .....</b>	<b>10-47</b>
<b>10-8</b>	<b>Extending the Functions in a Measurement Flow or Scene [Scene Control Macro Tool] .....</b>	<b>10-48</b>
<b>10-9</b>	<b>Positioning workpieces for stage and robot applications [Alignment Function] .....</b>	<b>10-49</b>
10-9-1	Overview .....	10-49
10-9-2	Execution of Calibration .....	10-52
10-9-3	Troubleshooting .....	10-59
10-9-4	Alignment .....	10-60
10-9-5	Alignment Processing Items .....	10-67

## Section 11 What to Do!

<b>11-1</b>	<b>Error Messages and Troubleshooting .....</b>	<b>11-2</b>
<b>11-2</b>	<b>FAQ .....</b>	<b>11-9</b>
11-2-1	During Start-up .....	11-9
11-2-2	During Operation .....	11-10
11-2-3	For Measurement .....	11-11
11-2-4	About Parallel Interface .....	11-12
11-2-5	Serial Interface (RS-232C/422 Connection) .....	11-13
11-2-6	Camera with Lighting Controller .....	11-14

## Appendices

<b>A-1</b>	<b>Menu List .....</b>	<b>A-2</b>
<b>A-2</b>	<b>External Tool List .....</b>	<b>A-5</b>
<b>A-3</b>	<b>FHV series Processing items .....</b>	<b>A-6</b>
<b>A-4</b>	<b>FHV series tools .....</b>	<b>A-9</b>
<b>A-5</b>	<b>Measurement Mechanism .....</b>	<b>A-10</b>
A-5-1	Color Processing Mechanism .....	A-10
A-5-2	Search Processing Mechanism .....	A-11
A-5-3	Edge Detection Measurement .....	A-14
A-5-4	Defect Detection Measurement .....	A-18
A-5-5	Handling Coordinates .....	A-19
<b>A-6</b>	<b>Image file .....</b>	<b>A-20</b>
<b>A-7</b>	<b>About Number of Logging Images .....</b>	<b>A-23</b>
<b>A-8</b>	<b>About Max. Number of Loading Images during Multi-input .....</b>	<b>A-27</b>
<b>A-9</b>	<b>About Memories Usable with FH series/FZ5 series .....</b>	<b>A-29</b>
<b>A-10</b>	<b>Memory Usage Guidance For Processing Items .....</b>	<b>A-30</b>
<b>A-11</b>	<b>Memory Display Image on PLC I/O .....</b>	<b>A-35</b>
<b>A-12</b>	<b>Sharing Data Within the Controller [User Data Tool] .....</b>	<b>A-37</b>
A-12-1	Setting Procedure for User Data .....	A-37
<b>A-13</b>	<b>About Limits on the Number of Image Input Processing Items Used .....</b>	<b>A-39</b>
<b>A-14</b>	<b>Operation log input information list .....</b>	<b>A-40</b>
<b>A-15</b>	<b>Character Code Table .....</b>	<b>A-53</b>
<b>A-16</b>	<b>List for Processing Item Identifier .....</b>	<b>A-54</b>

## Index

---



# Terms and Conditions Agreement

## Warranty, Limitations of Liability

### Warranties

#### ● Exclusive Warranty

Omron's exclusive warranty is that the Products will be free from defects in materials and workmanship for a period of twelve months from the date of sale by Omron (or such other period expressed in writing by Omron). Omron disclaims all other warranties, express or implied.

#### ● Limitations

OMRON MAKES NO WARRANTY OR REPRESENTATION, EXPRESS OR IMPLIED, ABOUT NON-INFRINGEMENT, MERCHANTABILITY OR FITNESS FOR A PARTICULAR PURPOSE OF THE PRODUCTS. BUYER ACKNOWLEDGES THAT IT ALONE HAS DETERMINED THAT THE PRODUCTS WILL SUITABLY MEET THE REQUIREMENTS OF THEIR INTENDED USE.

Omron further disclaims all warranties and responsibility of any type for claims or expenses based on infringement by the Products or otherwise of any intellectual property right.

#### ● Buyer Remedy

Omron's sole obligation hereunder shall be, at Omron's election, to (i) replace (in the form originally shipped with Buyer responsible for labor charges for removal or replacement thereof) the non-complying Product, (ii) repair the non-complying Product, or (iii) repay or credit Buyer an amount equal to the purchase price of the non-complying Product; provided that in no event shall Omron be responsible for warranty, repair, indemnity or any other claims or expenses regarding the Products unless Omron's analysis confirms that the Products were properly handled, stored, installed and maintained and not subject to contamination, abuse, misuse or inappropriate modification. Return of any Products by Buyer must be approved in writing by Omron before shipment. Omron Companies shall not be liable for the suitability or unsuitability or the results from the use of Products in combination with any electrical or electronic components, circuits, system assemblies or any other materials or substances or environments. Any advice, recommendations or information given orally or in writing, are not to be construed as an amendment or addition to the above warranty.

See <http://www.omron.com/global/> or contact your Omron representative for published information.

### Limitation on Liability; Etc

OMRON COMPANIES SHALL NOT BE LIABLE FOR SPECIAL, INDIRECT, INCIDENTAL, OR CONSEQUENTIAL DAMAGES, LOSS OF PROFITS OR PRODUCTION OR COMMERCIAL LOSS IN ANY WAY CONNECTED WITH THE PRODUCTS, WHETHER SUCH CLAIM IS BASED IN CONTRACT, WARRANTY, NEGLIGENCE OR STRICT LIABILITY.

Further, in no event shall liability of Omron Companies exceed the individual price of the Product on which liability is asserted.

## Application Considerations

### ● Suitability of Use

Omron Companies shall not be responsible for conformity with any standards, codes or regulations which apply to the combination of the Product in the Buyer's application or use of the Product. At Buyer's request, Omron will provide applicable third party certification documents identifying ratings and limitations of use which apply to the Product. This information by itself is not sufficient for a complete determination of the suitability of the Product in combination with the end product, machine, system, or other application or use. Buyer shall be solely responsible for determining appropriateness of the particular Product with respect to Buyer's application, product or system. Buyer shall take application responsibility in all cases.

NEVER USE THE PRODUCT FOR AN APPLICATION INVOLVING SERIOUS RISK TO LIFE OR PROPERTY OR IN LARGE QUANTITIES WITHOUT ENSURING THAT THE SYSTEM AS A WHOLE HAS BEEN DESIGNED TO ADDRESS THE RISKS, AND THAT THE OMRON PRODUCT(S) IS PROPERLY RATED AND INSTALLED FOR THE INTENDED USE WITHIN THE OVER-ALL EQUIPMENT OR SYSTEM.

### ● Programmable Products

Omron Companies shall not be responsible for the user's programming of a programmable Product, or any consequence thereof.

## Disclaimers

### ● Performance Data

Data presented in Omron Company websites, catalogs and other materials is provided as a guide for the user in determining suitability and does not constitute a warranty. It may represent the result of Omron's test conditions, and the user must correlate it to actual application requirements. Actual performance is subject to the Omron's Warranty and Limitations of Liability.

## Change in Specifications

Product specifications and accessories may be changed at any time based on improvements and other reasons. It is our practice to change part numbers when published ratings or features are changed, or when significant construction changes are made. However, some specifications of the Product may be changed without any notice. When in doubt, special part numbers may be assigned to fix or establish key specifications for your application. Please consult with your Omron's representative at any time to confirm actual specifications of purchased Product.

## Errors and Omissions

Information presented by Omron Companies has been checked and is believed to be accurate; however, no responsibility is assumed for clerical, typographical or proofreading errors or omissions.

# Safety Precautions







● **Symbols and the meanings for safety precautions described in this manual.**

In order for the product to be used safely, the following indications are used in this book to draw your attention to the cautions. The cautions with the indications describe the important contents for safety.

 <b>WARNING</b>	Indicates a potentially hazardous situation which, if not avoided, will result in minor or moderate injury, or may result in serious injury or death. Additionally there may be significant property damage.
--	---









 <b>CAUTION</b>	Indicates a potentially hazardous situation which, if not avoided, may result in minor or moderate injury or in property damage.
--	--

● **Meanings of Alert Symbols**

	General Prohibition Indicates general prohibitions, including warnings, for which there is no specific symbol.
	General Caution Indicates general cautions, including warnings, for which there is no specific symbol.
	Electrical Hazard Indicates the possible danger of electric shock under specific conditions.
	Explosion Hazard Indicates the possible danger of explosion under specific conditions.
	Laser Radiation Hazard Indicates the possible danger of laser radiation or light.
	High Temperature Caution Indicates the possible danger of injury by high temperature under specific conditions.

● Alert statements in this Manual

 **WARNING**

<p>This product must be used according to this manual or Instruction sheet. Failure to observe this may result in impairment of functions and performance of the product.</p>	
<p>This product is not designed or rated for ensuring safety of persons. Do not use it for such purposes.</p>	
<p>Never connect the AC power supply with this product. When the AC power supply is connected, it causes the electric shock and a fire.</p>	
<p>A lithium battery is built into the Controller and may occasionally combust, explode, or burn if not treated properly. Dispose of the Controller as industrial waste, and never disassemble, apply pressure that would deform, heat to 100°C or higher, or incinerate the Controller.</p>	
<p>Since camera that can be connected with this product emits a visible light that may have an adverse effect on the eyes, do not stare directly into the light emitted from the LED. If a specular object is used, take care not to allow reflected light enter your eyes.</p>	
<p>Do not touch the terminals while the power supply is ON. Doing so may result in electrical shock.</p>	
<p>Please take external safety measures so that the system as a whole should be on the safe side even if a failure of a Sensor Controller or an error due to an external factor occurred. An abnormal operation may result in serious accident.</p>	
<p>Please take fail-safe measures on your side in preparation for an abnormal signal due to signal conductor disconnection and/or momentary power interruption. An abnormal operation may result in a serious accident.</p>	

 **CAUTION**

<p>Danger of burns. Do not touch the case while the LED is ON or just after power is turned OFF, since it remains extremely hot.</p>	
--	---

# Precautions for Safe Use

---

## Condition of the fitness of OMRON products

---

- Please do not use this product to directly or indirectly use to detect the human body for the purpose of ensuring the safety. In the same application, please use the safety sensor that is published on our sensor catalog.
- Omron products are designed and manufactured as general-purpose products for use in general industrial applications. They are not intended to be used in the following critical applications. If you are using Omron products in the following applications, Omron shall not provide any warranty for such Omron products, unless otherwise specifically agreed or unless the specific applications are intended by Omron.
  - (a) Applications with stringent safety requirements, including but not limited to nuclear power control equipment, combustion equipment, aerospace equipment, railway equipment, elevator/lift equipment, amusement park equipment, medical equipment, safety devices and other applications that could cause danger/harm to people's body and life.
  - (b) Applications that require high reliability, including but not limited to supply systems for gas, water and electricity, etc., 24 hour continuous operating systems, financial settlement systems and other applications that handle rights and property.
  - (c) Applications under severe condition or in severe environment, including but not limited to outdoor equipment, equipment exposed to chemical contamination, equipment exposed to electromagnetic interference and equipment exposed to vibration and shocks
  - (d) Applications under conditions and environment not described in specifications
- \*1. In addition to the applications listed from (a) to (d) above, Omron products (see definition) are not intended for use in vehicles designed human transport (including two wheel vehicles). Please do NOT use Omron products for vehicles designed human transport. Please contact the Omron sales staff for information on our automotive line of products.
- \*2. The above is part of the Terms and Conditions Agreement. Please use carefully read the contents of the guarantee and disclaimers described in our latest version of the catalog, data sheets and manuals.

## Installation Environment (FH/FZ5 series)

---

- Do not use the product in areas where flammable or explosive gases are present.
- Install the product so that air can flow freely through its cooling vents.
- Clean the ventilation holes and fan outlet regularly to prevent dust and particles from clogging them. If they are blocked, heat is trapped inside, causing a malfunction.
- Do not install the product close to high-voltage devices and power devices in order to secure the safety of operation and maintenance.
- Make sure to tighten all installation screws securely.
- When mounting the Sensor Controller using the DIN rail mounting bracket, make sure the screw is tightened.
- Make sure to mount the product on DIN-rail securely.



## Installation Environment (FHV series)

---

- Do not use the product in areas where flammable or explosive gases are present.
- Do not install the product close to high-voltage devices and power devices in order to secure the safety of operation and maintenance.
- Do not install the product to a place where vibrations and/or impacts are expected.
- Do not install the product near to a device causing noises. If the product is installed in a noisy environment and operational errors are caused, be sure to take shielding measures.

## Power Supply and Wiring (FH/FZ5 series)

---

- Make sure to use the product with the power supply voltage specified by this manual or Instruction sheet.
- Do not connect AC power source to Sensor Controller. If connects AC power source, it might be a cause of the failure.
- Use the wire of a suitable size (AWG 16 to 12) according to the current consumption.
- Use a DC power supply with safety measures against high-voltage spikes (safety extra low-voltage circuits on the secondary side).
- Keep the power supply wires as short as possible.
- Do the following confirmations again before turning on the power supply.
  - Is the voltage and polarity of the power supply correct? (24 VDC)
  - Is not the load of the output signal short-circuited?
  - Is the load current of the output signal appropriate?
  - Is not the mistake found in wiring?
  - Is the voltage and polarity of the encoder power (ENC0\_VDD/GND ENC1\_VDD/GND) supply? (5 VDC)
- The recommended power supply is the S8VS-□□□24 (manufactured by OMRON) or S8VK-G-□□□24 (manufactured by OMRON).

## Power Supply and Wiring (FHV series)

---

- Make sure to use the product with the power supply voltage specified. If a DC voltage exceeding the rating or an AC voltage is applied, the circuit parts may be burnt or exploded.
- Do not connect the power supply with polarity reversed.
- Use a DC power supply with safety measures against high-voltage spikes (safety extra low-voltage circuits on the secondary side).
- Use an independent power source for this product. Do not use a shared power source.
- Never apply more than the rated voltage or AC power supply to this product. It may cause malfunction.
- The recommended power supplies are as follows:
  - When attaching the lighting module, use S8VK-G06024 (OMRON) or S8VS-06024 (OMRON).
  - When not attaching the lighting module, use S8VK-G06024 (OMRON) or S8VS-06024 (OMRON).
- Wire high-voltage cables or power cables separately from the cables of this product. If the same cable or duct is used, the product may receive induction and it may cause malfunctioning or breakage.
- Do not short-circuit load on the open collector output.
- Apply load not exceeding the rating.
- When wiring, put a crimp terminal of the specified size. Do not connect wires simply twisted together to the power supply or terminal block directly.

- If using an I/O cable 20 m long, confirm that the power supply output is 24 VDC or higher. If it is lower than 24 VDC, the product does not operate.
- Cut off unnecessary signal wires so that they do not contact any other signal wires.
- After wiring the cables, confirm if the power supply is appropriate, if there is miswiring such as short-circuit of load, if the load current is appropriate, and if FG is connected appropriately. Otherwise, the product may be broken due to miswiring etc.
- Take enough safety measures such as a failsafe circuit before using the product.
- Be sure to apply Class D grounding (100Ω or lower grounding resistance) to the case of the smart camera and the ground wire of the I/O cable.
- Do not share the ground wire with some other devices or connect it to the beam of the building. The product may be adversely affected.
- Determine the contact point as near as possible to shorten the ground wire as much as possible. The product may be adversely affected.

## Ground

- Make sure the power supply circuit of the FH Sensor Controller is insulated from the internal circuit. Refer to this manual or Instruction sheet.
- When the connected camera to Sensor Control comes packaged with a base, make sure to mount with the base. Since the enclosure of the camera main body made of metals is short-circuited with the internal circuit, the internal circuit might be short-circuited with FG if no base is used, so that failures or malfunctions may be caused.  
Perform Class D grounding (with a grounding resistance of 100 Ω or less).  
Keep the ground line as short as possible by setting the grounding point as close as possible.  
Ground the FH Sensor Controller independently. If sharing the ground line with other devices or connecting it with a building beam, the Sensor Controller might be adversely effected.
- Check wiring again before turning on the FH Sensor Controller.
- Do not ground the plus (+) terminal when the FH series Sensor Controller is connected to the FH-SC12/FH-SM12. Doing so may cause a short circuit of the internal circuit, resulting in a malfunction.  
The internal circuit is possible to be given damage, it can be cause the failure.
  - FH-1000 series
  - FH-2000 series
  - FH-3000 series
  - FH-5000 series
  - FH-L series
- Do not ground the plus (+) terminal of the 24 VDC power source when the FH series Sensor Controller is connected to the FH-MT12 with a USB cable. Doing so may cause a short circuit of the internal circuit, resulting in a malfunction.
  - FH-1000 series
  - FH-2000 series
  - FH-3000 series
  - FH-5000 series
  - FH-L series

## Mounting (FHV series)

---

- When doing the following, be sure to turn OFF the power of the smart camera main unit or connected peripheral devices. Not doing so leads to a product failure.
  - Cable connection and wiring
  - Connector mounting/removal
  - Lighting module mounting/removal
  - Lens module mounting/removal
- Tighten the mounting screws securely using the defined torque and order described in the Setup Manual.
- Mount the lens module in the correct direction. Mounting it in the wrong direction may cause malfunction of the device or injury.
- After removing the cable, be sure to put the connector cap. If the connector cap is not put, the product may malfunction or be broken due to entering of foreign materials.
- For the component with a lock mechanism, be sure to confirm that it is locked before using the product.
- Do not apply torsional stress to the cable. Doing so may cause cable breakage.
- Secure the minimum bending radius of the cable. If it cannot be secured, the cable may be broken.
- Assemble as avoiding the water-proof packings and harnesses from being caught by the case, etc.
- Do not use any damaged water-proof packings and light shielding sheet or assemble the product with foreign materials attached to or caught in.
- Mount the lens module and lighting model in the correct direction. Mounting them in the wrong direction may cause broken or malfunction of the device, or injury.
- Do not touch the lens or image sensor with bare hands. Doing so may lead to malfunctioning or breakage. Assemble the lens and image sensor with a correct combination. If not, malfunction may result.

## Other (FH/FZ5 series)

---

- Use only the camera and cables designed specifically for the product. Use of other products may result in malfunction or damage of the product.
- Always turn OFF the power of the Sensor Controller and peripheral devices before connecting or disconnecting a camera or cable. Connecting the cable with power supplied may result in damage of the camera or peripheral devices.
- For the cable that is flexed repeatedly, use the robotic cable type (Bend resistant camera cable) to prevent damages.
- Do not apply torsion stress to the cable. It may damage the cable.
- Secure the minimum bending radius of the cable. Otherwise the cable may be damaged.
- Do not attempt to dismantle, repair, or modify the product.
- Should you notice any abnormalities, immediately stop use, turn OFF the power supply, and contact your OMRON representative.
- While the power is ON or immediately after the power is turned OFF, the Sensor Controller and camera case are still hot. Do not touch the case.
- When disposing of the product, treat it as an industrial waste.
- Do not drop the product nor apply excessive vibration or shock to the product. Doing so may cause malfunction or burning.
- This product is heavy. Be careful not to drop it while handling.
- A lithium battery is incorporated, so a severe injury may rarely occur due to ignition or explosion.
- Be sure to take fail-safe measures externally when controlling stages and robots by using the measurement results of the Sensor Controller (axis movement output by calibration and alignment measurement).

## Other (FHV series)

---

- Use only the dedicated cable (FHV-VN□/FHV-VD□), camera-mount lighting controller (FL-TCC□/FLV-TCC□), lighting module (FHV-LTM-□), and lens module (FHV-LEM-□). Otherwise, the product may malfunction or be broken.
- If anything abnormal occurs, for example, strange smell/sound is detected, the main unit gets very hot, or a smoke comes, stop using the product, turn OFF the product, and consult OMRON's branch or sales office.
- Do not disassemble, deform by pressurizing, incinerate, repair, or alter this product.
- When disposing of the product, treat as industrial waste.
- Do not drop the product or expose it to abnormal vibration or impact. Doing so may lead to product failure.
- If using the measurement result of the smart camera to operate the stage or robot (output of axis moving distance by calibration and alignment measurement), be sure to take failsafe measures externally.
- The water-proof packing and light shielding sheet are rubber products. Avoid storing them in a location where rubber deteriorates.

# Precautions for Correct Use

---

## Installation and Storage Sites for FH-1000/2000/3000/5000 series/FZ5-800/1100/1200 series/FZ5-600 series/FZ5-L series

---

Install and store the product in a location that meets the following conditions:

- Surrounding temperature of 0 to +50°C \*1
- No rapid changes in temperature (place where dew does not form)
- Relative humidity of between 35 to 85%
- No presence of corrosive or flammable gases
- Place free of dust, salts and iron particles
- Place free of vibration and shock
- Place out of direct sunlight
- Place where it will not come into contact with water, oils or chemicals

\*1. 0 to +45°C for FH-5000 series

## Installation and Storage Sites for FH-L series

---

Install and store the product in a location that meets the following conditions:

- Surrounding temperature of 0 to +55°C (-25 to +70°C in storage)
- No rapid changes in temperature (place where dew does not form)
- Relative humidity of between 10 to 90%
- No presence of corrosive or flammable gases
- Place free of dust, salts and iron particles
- Place free of vibration and shock
- Place out of direct sunlight
- Place where it will not come into contact with water, oils or chemicals
- Place not affected by strong electro-magnetic waves
- Place not near to high-voltage, or high-power equipment

## Installation and Storage Sites for FHV series

---

In order to prevent the product from becoming inoperable or malfunction, and to prevent other adverse effects to the performance or equipment, please observe the following.

- A location where the ambient temperature does not exceed the rated range (operating: 0 to 40°C, storage: -25 to 65°C).
- A location where the temperature does not vary sharply (condensation occurs).
- A location where relative temperature does not exceed a range of 35-85%RH.
- A location not exposed to corrosive gases or combustible gases.
- A location not exposed to dust, salt, or metal powder.
- A location not exposed to direct vibration or impact.
- A location not exposed to strong disturbance light (laser light, arc welding light, or ultraviolet light).
- A location not near a heating appliance or exposed to direct sunlight.
- A location not exposed to mist of water, oil, or chemicals or misty atmosphere.
- A location not exposed to strong magnetic/electric fields.
- A location not near a high-voltage device or power device
- A location where rubber quality is not deteriorated.

## Orientation of Product

---

- For good heat dissipation, install the product only in the position written this manual or Instruction sheet so as not to block the ventilation holes.

## Ambient Temperature

---

- For good heat dissipation, keep the distance written this manual or Instruction sheet.
- Do not install the product immediately above significant heat sources, such as heaters, transformers, or large-capacity resistors.
- Do not let the ambient temperature exceed an operating temperature range.
- Provide a forced-air fan cooling or air conditioning if the ambient temperature is near the upper range of operating temperature range so that the ambient temperature never exceeds the upper range of operating temperature range.

## Noise Resistance

---

- Do not install the product in a cabinet containing high-voltage equipment.
- Do not install the Sensor Controller within 200 mm of power cables.

## Component Installation and Handling (FH/FZ5 series)

---

- Touching Signal Lines  
To prevent damage from static electricity, use a wrist strap or another device for preventing electrostatic discharges when touching terminals or signal lines in connectors.
- Handling a USB Memory/SD memory card.  
Refer to *Using an External Storage Device* in the *Vision System FH/FHV/FZ5 series User's Manual* (Cat. No. W365).
- Do not insert an SD memory card in the reverse orientation, at an angle, or in a twisting manner.  
Before removing a USB memory device or SD memory card, make sure that data is not being read or written to them.  
For a USB memory device, the memory device's LED flashes while data is being read or written. Make sure that the LED stops flashing before removing the memory device.  
For an SD memory card, the SD BUSY LED of Sensor Controller flashes while data is being read or written. Make sure that the LED stops flashing before removing the card.
- Turning OFF the Power  
When a message is displayed indicating that a task is in progress, do not turn OFF the power. Doing so causes the data in the memory to be corrupted, resulting in the product not operating properly upon the next start-up.  
When turns OFF, conform the followings proceedings have completed. and then operate again.
  - When saves using Sensor Controller:  
Confirm the save processing is completed and next operation is possible.
  - When saves using communication command:  
Intended command is completed. BUSY signal is turned OFF
- Setting of Power Source  
The power source need to be supplied from DC power source apparatus which is taken a save ultra-low voltage circuit: to protect high voltage.

## Component Installation and Handling (FHV series)

---

- If using a commercially available switching regulator, earth the frame ground terminal.
- If the power supply line has surge, connect a surge absorber according to the operational environment to use the product.
- After wiring the cables, confirm if the power supply is appropriate, if there is miswiring such as short-circuit of load, or if the load current is appropriate. Otherwise, the product may be broken due to miswiring etc.
- Do not put load on the cables and connectors before wiring them.
- Do not turn OFF the power supply while data are being saved in the smart camera. Otherwise, data on the memory is broken, so the product does not operate normally when started up next time.
- When turning OFF the power, confirm that data have been saved completely before starting operations.
  - When data are saved by operating the sensor controller, the saving process must have been completed and the following user operations must be possible.
  - When data are saved using communication commands, processing of the applicable commands must have been completed and the busy state is OFF.
- If contacting a terminal or a signal cable inside the connector, use a wrist strap to take antistatic measures to prevent breakage due to static electricity.
- If removing the micro SD card, confirm that data are not being read or written before removing it.
- Do not insert the micro SD card inversely, obliquely, or as twisting it.
- While data are being read in or written to the micro SD card, the SD ACCESS LED on the Smart Camera main unit is turned on for a while. Remove the card after confirming that the LED is completely turned off.
- Except when inserting or removing the micro SD card, put the cover of the micro SD card inserting connector and screw it up before using the product.
- When a message indicating that processing is being executed is displayed on the screen, do not turn OFF the power. Otherwise, data on the memory is broken, so the product does not operate normally when started up again.
- Do not use the product in environments subject to water droplets when an external lighting is connected. The main unit may be broken.
- The RS-232C communication standard defines the maximum cable length as 15 m. Implement this communication using an I/O cable 2/3/5/10 m long.
- When connecting cables, align terminals and connect them straightly. If not, the terminals bent and may cause malfunction or unable to communicate normally.

## Maintenance

---

- Turn OFF the power and ensure the safety before maintenance.
- Clean the lens with a lens-cleaning cloth or air brush.
- Lightly wipe off dirt with a soft cloth.
- Dirt on the image element must be removed using an air brush.
- Do not use thinners or benzene.
- To ensure safe access for operation and maintenance, separate the Sensor Controller as much as possible from high-voltage equipment and power machinery.

## Maintenance (FHV series)

---

- Be sure to put the cap/cover onto the connector not used. Otherwise, the product may malfunction or get out of order due to entering of foreign materials.

## Communication with High-order Device

---

- After confirming that this product is started up, communicate with the high-order device. When this product has started up, an indefinite signal may be output from the high-order interface. To avoid this problem, clear the receiving buffer of your device at initial operations.

## Fail-Safe Measures

---

- When controlling stages and robots using the measurement results from the Sensor Controller (axis movement output based on calibration and alignment measurement), always take fail-safe measures within the stage and robot systems, such as checking whether the data obtained from the measurement results is within the range of movement of the stages and robots.
- On a FH Sensor Controller side, supplementary use operations and branches of the Sensor Controller to configure a check flow such as “data should not be externally provide if the data is in a range from -XXXXX to XXXXX” based on the stage/robots range of movement.

## Connecting the Sensor Controller and Monitor with a Switcher and Splitter (FH/FZ5 series)

---

- Do not use devices that make the Sensor Controller recognize the monitor again when switching operation is performed. Re-recognition process in switching operation has an effect such as a delay in measurement time.

## Beam (FHV series)

---

- The beam center may vary product by product. When mounting this module, be sure to confirm the center position of the video on the monitor.  
The beam center of this product may vary over a couple of pixels due to the variation of ambient temperature because of the material characteristics.
- Select the model by confirming the field of view and camera installation distance on the optical diagram. In addition, the field of view may vary product by product.  
When mounting this product, be sure to confirm video using the monitor.

## Image Sensor (FHV series)

---

- For this product, a line may appear depending on the measurement condition or sensitivity because of the specification of the image sensor.  
However, this is not a fault or failure of the product. In addition, although there may be multiple defective pixels, this is not a fault or failure of the product. Use the product as confirming the actual image.

## Communications with Upper Equipment (FHV series)

---

- Implement communications with upper equipment after confirming that this product has been started up. In addition, when this product is being started up, unstable signals may be issued by the upper interface. In the initial operation, take action such as clearing the receiving buffer of the equipment used.



## Failsafe Measures (FHV series)

---

- When operating a stage or robot using measurement results of the Smart Camera (axis moving distance output by the calibration or alignment measurement), take measures as follows: Be sure to operate the stage or robot after confirming the measurement result data on the stage or robot side that the data are within the movable range of the stage or robot.

## Warm-up (FHV series)

---

- Turn ON the power and wait for 60 minutes or more before conducting precise inspection. The circuit is not stable directly after the power is turned ON, so brightness may vary gradually.

## Camera Installation (FHV series)

---

- In an environment exposed to high humidity and sharp temperature fluctuation, the inside of the lighting cover may become cloudy in rare cases. If it becomes cloudy, remove the lighting cover and wipe off the inside with a soft cloth.
- If installing smart camera main units side by side, secure a space of 30 mm or more wide between them.

## Others (FHV series)

---

- For better heat radiation, use the separately sold fitting (FHV-XMT-7) or mount the product to the metal frame (recommended size: 100×110 mm or more and thickness: 10 mm or more).
- Do not assemble the lighting module or water-proof hood in a hot and humid environment. Otherwise, condensation may occur. If it becomes cloudy, remove the lighting cover and wipe off the moisture with an absorbent, but soft cloth so as not to damage the product.
- There are two types of polarizing filters: FHV-XPL (for visible light) and FHV-XPL-IR (for both visible and infrared lights). Use the appropriate option according to the illumination light source.
- If switching the focus for a long period of time continuously except when installing and adjusting the product, performance may be degraded due to heat generation or abrasion of inner parts.
- When the lens module is mounted to the product, the specifications of vibration tolerance are changed.
- Do not touch the lens module after it is mounted. Otherwise, it may be broken.
- If using this product without attaching the lighting module in an environment needing water-proof, use water-proof hood FHV-XHD series.
- Operate the product by using Calculation and Branch processing items on the Smart Camera side additionally and creating a check flow, for example, if the stage or robot is within a range of -xxxxx to xxxxx from its movable range, data are not output to outside.
- The lighting module and lens module are fixed to the smart camera with dropout preventing screws. Do not remove them from the product.

## LED Safety (FHV series)

This product is classified into the following risk groups by IEC62471.

Model	Color	LED safety	Display
FHV-LTM-W	White	Risk group 2	A
FHV-LTM-R	Red	Risk group 1	B
FHV-LTM-IR	Infrared light	Risk group 1	C
FHV-LTM-MC	Red	Risk group 1	B
	Green	Risk group 2	A
	Blue	Risk group 2	A
	Infrared light	Risk group 1	C

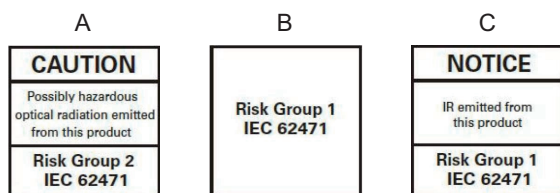

# Regulations and Standards

## All Series

### Using Product Outside Japan

This regulation applies to FH/FHV/FZ5 sensor controller and peripheral devices.

If you export (or provide a non-resident with) this product or a part of this product that falls under the category of goods (or technologies) specified by the Foreign Exchange and Foreign Trade Control Law as those which require permission or approval for export, you must obtain permission or approval or service transaction permission) pursuant to the law.

### U.S. California Notice:

This product contains a lithium battery for which the following notice applies: Perchlorate Material - special handling may apply.

See [www.dtsc.ca.gov/hazardouswaste/perchlorate](http://www.dtsc.ca.gov/hazardouswaste/perchlorate)

### Conformance to KC Standards

This regulation applies to FH/FHV/FZ5 sensor controller and peripheral devices.

Observe the following precaution if you use this product in Korea.

A 급 기기 (업무용 방송통신기자재)

이 기기는 업무용(A 급) 전자파적합기기로서 판매자 또는 사용자는 이 점을 주의하시기 바라며, 가정외의 지역에서 사용하는 것을 목적으로 합니다.

- Class A Device (Broadcasting Communications Device for Office Use)  
This device obtained EMC registration for office use (Class A), and it is intended to be used in places other than homes. Sellers and/or users need to take note of this.

## FH-1000/2000/3000/5000 series

### Conformance to EC/EU Directives

This Sensor Controller is compliant with the standards below:

- EC Directive 2004/108/EC (Until April 19 2016) / EU Directive 2014/30/EU (After April 20 2016)  
EN61326-1  
Electromagnetic environment: Industrial electromagnetic environment (EN/IEC 61326-1 Table 2)
- Also, the following condition is applied to the immunity test of this product.
  - If the level of disturbance of the video is such that characters on the monitor are readable, the test is a pass.
- This product complies with EC/EU Directives. EMC-related performance of the OMRON devices that comply with EC/EU Directives will vary depending on the configuration, wiring, and other conditions of the equipment or control panel on which the OMRON devices are installed.

- The customer must, therefore, perform the final check to confirm that devices and the overall machine conform to EMC standards.
- If there is a need to respond to the EC / EU directive, please use by an analog RGB output.

### Conformance to UL Standards

---

This regulation applies to FH-1000 and FH-3000 series Sensor Controller and peripheral devices.

This product complies with UL Standards.

- UL508

This regulation applies to FH-2000 and FH-5000 series Sensor Controller and peripheral devices.

This product complies with UL Standards.

- UL61010-2-201

## FH-L series

### Conformance to EC/EU Directives

---

This Sensor Controller is compliant with the standards below:

- EC Directive 2004/108/EC (Until April 19 2016) / EU Directive 2014/30/EU (After April 20 2016)  
EN61326-1  
Electromagnetic environment: Industrial electromagnetic environment (EN/IEC 61326-1 Table 2)
- Also, the following condition is applied to the immunity test of this product.
  - If the level of disturbance of the video is such that characters on the monitor are readable, the test is a pass.
- This product complies with EC/EU Directives. EMC-related performance of the OMRON devices that comply with EC/EU Directives will vary depending on the configuration, wiring, and other conditions of the equipment or control panel on which the OMRON devices are installed.
- The customer must, therefore, perform the final check to confirm that devices and the overall machine conform to EMC standards.
- If there is a need to respond to the EC / EU directive, please use by an analog RGB output.

### Conformance to UL Standards

---

This regulation applies to FH-L series Sensor Controller and peripheral devices.

This product complies with CSA Standards.

- UL 61010-2-201

## FHV series

### Conformance to EC/EU Directives

---

The product is compliant with the standards below:

- EU Directive 2014/30/EU (After April 20 2016)/EU EN61326-1 Electromagnetic environment: Industrial electromagnetic environment (EN/IEC 61326-1 Table 2)
- This product complies with EC/EU Directives. EMC-related performance of the OMRON devices that comply with EC/EU Directives will vary depending on the configuration, wiring, and other conditions of the equipment or control panel on which the OMRON devices are installed.
- The customer must, therefore, perform the final check to confirm that devices and the overall machine conform to EMC standards.

## FZ5 series/FZ5-L series

### Conformance to EC/EU Directives

---

This Sensor Controller is compliant with the standards below:

- EC Directive 2004/108/EC (Until April 19 2016) / EU Directive 2014/30/EU (After April 20 2016) EN61326-1
- Electromagnetic environment: Industrial electromagnetic environment (EN/IEC 61326-1 Table 2)
- Also, the following condition is applied to the immunity test of this product.
  - If the level of disturbance of the video is such that characters on the monitor are readable, the test is a pass.
- This product complies with EC/EU Directives. EMC-related performance of the OMRON devices that comply with EC/EU Directives will vary depending on the configuration, wiring, and other conditions of the equipment or control panel on which the OMRON devices are installed.
- The customer must, therefore, perform the final check to confirm that devices and the overall machine conform to EMC standards.

### Conformance to CSA Standards

---

This product complies with CSA Standards.

- CSA C22.2 No.61010-1

# Revision History

---

A manual revision code appears as a suffix to the catalog number on the front and back covers of the manual.

**Cat. No. Z365-E1-05**

↑  
Revision code

Rev. No.	Rev. Date	Revision Contents	Software Version
01	Apr. 2016	Additional descriptions of software updates, FH-L series product information and catalogue number revisions for Ver. 5.55.	Ver. 5.60
02	Mar. 2017	Additions for software version upgrade.	Ver. 5.71
03	Jun. 2017	Additions for software version upgrade.	Ver. 5.72
04	Jul. 2018	Additions for software version upgrade.	Ver. 6.10
05	Nov. 2018	Additions for software version upgrade.	Ver. 6.20

# 1

## Overview

---

This section describes the basic flow and preparations that are necessary to start operation.

---

<b>1-1</b>	<b>Checking the System Configuration</b>	<b>1-2</b>
1-1-1	System Configuration	1-2
1-1-2	Functional Comparison between the FH-series, FHV-series and FZ5-series Controllers	1-3
<b>1-2</b>	<b>Flow of Application</b>	<b>1-7</b>

# 1-1 Checking the System Configuration

## 1-1-1 System Configuration

The FH/FHV/FZ5 is a Vision Sensor that uses a controller to process measurements of objects that are imaged with a Camera.

You connect an LCD for operations and monitoring, and various Cameras to the FH/FHV/FZ5-series Sensor Controller.

You connect external devices, such as a PLC or a computer, through a parallel, Ethernet, or RS-232C cable.

You can connect up to eight Cameras, depending on the model of the Controller.

To measure more than one line with a single Sensor Controller, you assign the Camera for the measurements to each line beforehand, and switch between Cameras during the measurement flow.

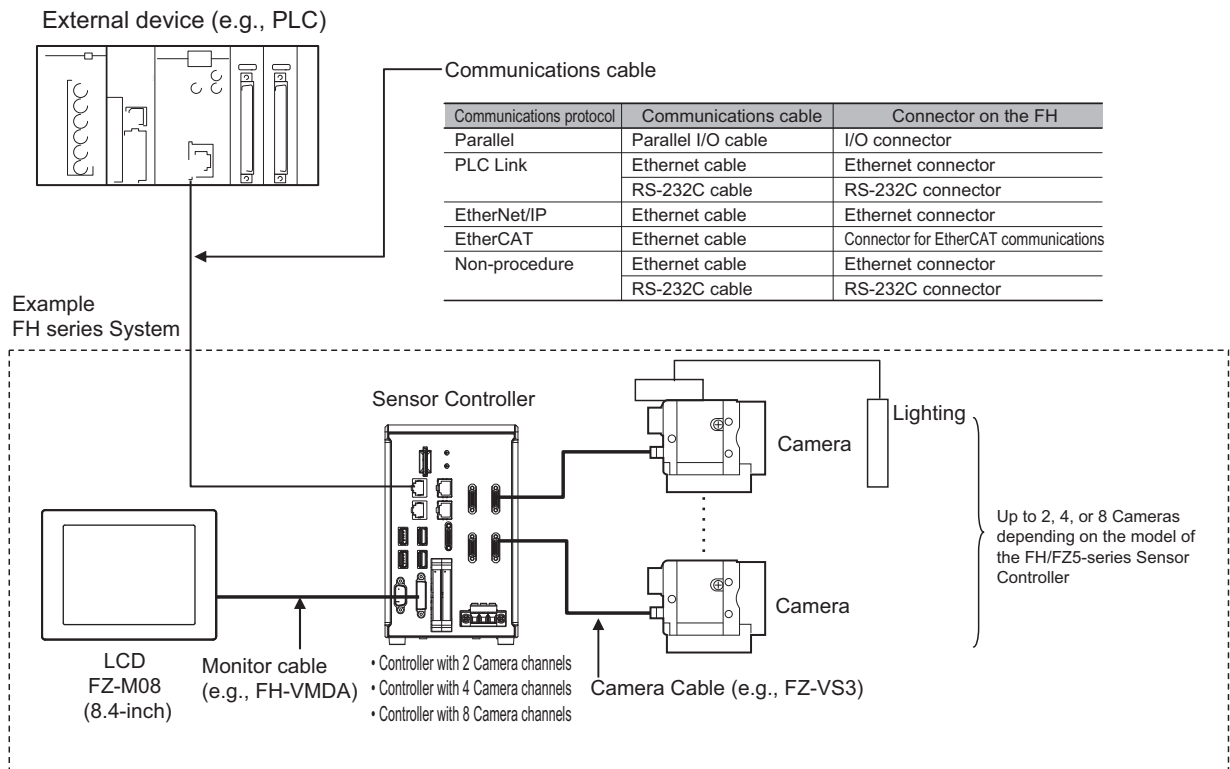

\*1. FZ-MEM2G or FZ-MEM8G USB Memory is sold separately.

For details of the system configuration each series or basic configuration, refer to the *Vision System FH/FHV/FZ5 series Hardware Setup Manual (Cat. No. Z366)/FHV Series Smart Camera Setup Manual (Z408)*.



## 1-1-2 Functional Comparison between the FH-series, FHV-series and FZ5-series Controllers

The following table shows the differences between the FH series, FHV series and FZ5 series.

The fastest measurement speed is FH-5000 series. The next speed is the following: FH-5000 series > FH-3000 series > FH-2000 series > FH-1000 series > FZ5-1200 series > FZ5-1100 series > FZ5-800 series > FZ5-600 series > FH-L series > FHV series > FZ5-L series. Select the appropriate Sensor Controller series according to the application as below table.

### Principal Difference

Controller model	FH Series					FHV Series	FZ5 Series			
	FH-□050-20	FH-□050-10	FH-□050	FH-L□□□-10	FH-L□□□		FZ5-11□□-10	FZ5-11□□	FZ5-L35□-10 FZ5-6□□-10	FZ5-L35□ FZ5-6□□
Number of Camera connections	8 *1	4	2	4	2	—	4	2	4	2
Operation mode *2										
Standard	Yes									
Double Speed Multi input	Yes								No	
Non-stop adjustent mode	Yes								No	
Multi-line random-trigger mode	Yes (Maximum 8 lines)			No			Yes (Maximum 2 lines)		No	
Number of scenes (number of line process changes)	128 *3									
Input interface										
EtherCAT	OK			—						
External storge										
USB memory	OK					—		OK		
SD memory card	OK					—				
microSD card	—					OK		—		
Sysmac Studio support	OK			—						

Controller model	FH Series					FHV Series	FZ5 Series				
	FH-□050-20	FH-□050-10	FH-□050	FH-L□□□-10	FH-L□□□		FHV7□-□□□□	FZ5-11□□-10	FZ5-11□□	FZ5-L35□-10 FZ5-6□□-10	FZ5-L35□ FZ5-6□□
Menu languages	Japanese, English, Simplified Chinese, Traditional, Chinese, Korean, German, French, Spanish, Italian, Vietnamese, and Polish						Japanese, English, Simplified Chinese, and Traditional Chinese* <sup>4</sup>				
Monitor Interface	DVI connection (Recognize the recommended resolution automatically) RGB connection (Resolution XGA 1024×768 dot)					—	LCD Integral Controller* <sup>5</sup>		FZ5-L35□ /FZ5-L35□-10 : (Resolution XGA 1024×768 dot) FZ5-6□□ /FZ5-6 □□-10 : LCD Integral Controller* <sup>5</sup>		

\*1. Up to four 12-/20.4-megapixel cameras can be connected. Do not connect more than five cameras when using only 12-/20.4-megapixel cameras. When mixing 12-/20.4-megapixel cameras with other cameras, you can connect up to four 12-/20.4-megapixel cameras and also connect up to four other cameras, so a total of eight cameras can be connected.

\*2. Select the Operation mode for your application purpose.

For Operation mode, refer to the following: Refer 4-4 *Setting Operation Mode [Startup Settings]* on page 4-12.

\*3. The Conversion Scene Group Data Tool allows you to create a scene group of more than 129 scenes.

\*4. Nine languages are selectable in the [Language setting] dialog box under [System Settings], however, only Japanese, English, Simplified Chinese, and Traditional Chinese can be used. If a language other than these four languages is selected, the menus will appear in English. The menus will also appear in English if system data with set languages other than these four languages is loaded.

\*5. Output to an external monitor is disabled in the default settings.

If output to an external monitor is needed, contact your OMRON representative.

## System Settings

Menu	Sub Menu	Tab	Group	Parameter	Sensor Controller's Model				
					FH series		FZV series	FZ5 series	
					FH-1000/2000/3000/5000 series	FH-L series		FZ5-800/1100/1200 series	FZ-600 series
Startup	Startup setting	Language Setting		Language	Yes			*1	
		Basic	Relocate memories	Relocate memories	No *2			Yes	
		Communication	Communication module select	Serial (RS-232C/422)	Yes	*3			
				FieldBus	Yes	*4			
		Operation mode	Operation mode setting	Operation mode	Yes	*5	Yes	No *6	
Parallel Execute	Yes			No *7					

Menu	Sub Menu	Tab	Group	Parameter	Sensor Controller's Model					
					FH series		FZV series	FZ5 series		
					FH-1000/2000/3000/5000 series	FH-L series		FZ5-800/1100/1200 series	FZ-600 series	FZ5-L series
Camera	Camera connection			Camera 0 to 7	*8					
	Inter-camera setting			STEP camera Delay 0 to 7						
				Transmission speed 0 to 7	*8	No*2				
	Output signal setting		Common setting		Output signal	*8			No*2	
			Line setting		SHTOUT delay					
					SHTOUT width					
					SHTOUT polarity					
Communication	Parallel	Confirmation	Input state	STEP0-7	Yes	*9	*10			
				DSA0-7		*11	No*2	*12		
				DI LINE0-2		No*2				
				ACK		Yes	No*2			
	RS-232C/422 (Normal)	Setting		Interface	No *13			Yes		
	Ethernet (Normal (UDP))	Setting		Address setting	*14	No*2		Yes		
				Address setting 2	Yes			No*2		
				Input/Output setting						Output IP address
Input port No										
			Output port No							
Other	Fan control setting			Low rotation/High rotation	No*2			Yes	No*2	
	Encoder trigger setting				Yes	No*2				
	Network drive setting			S-Z	Yes			*15		

\*1. Four languages are supported. If a non-supported language is selected, it will default to English.  
 \*2. Setting is disable.  
 \*3. Touch Panel Monitor (FH-MT12) is disable.  
 \*4. EtherCAT setting is disable.  
 \*5. Multi-line Random-trigger Mode setting is disable. If set Multi-line Random-trigger mode, perform in Standard mode.

- \*6. Operation mode tab is not displayed.
- \*7. Parallel processing tab is not displayed.
- \*8. Depending on the number of camera port of Sensor Controller.
- \*9. Enable only STEP 0 to 2.
- \*10. Enable only STEP 0.
- \*11. Enable only DSA 0 to 2.
- \*12. Enable only DSA 0.
- \*13. Disable to set. RS-422 is not supported.
- \*14. Supported only the Sensor Controller has 2 port: FH-□□□□-10, FH-□□□□-20
- \*15. Enable to set only 1 Sensor Controller under network.

## 1-2 Flow of Application

The following table shows the flow for using the FH/FHV/FZ5.

Procedure	Description	Reference
Preparations	Installation and Wiring	Vision System FH/FZ5 Series Hardware Setup Manual (Cat. No. Z366) FH Instruction Manual FZ5 Instruction Manual FHV Series Smart Camera Setup Manual (Z408) FHV Instruction Manual
	↓	
	Turning ON Power	Vision System FH/FZ5 Series Hardware Setup Manual (Cat. No. Z366) FH Instruction Manual FZ5 Instruction Manual FHV Series Smart Camera Setup Manual (Z408) FHV Instruction Manual
	↓	
	Language Selection in Dialog Box (only when the Sensor Controller is started for the first time)	Refer to <i>4-1 Selecting Language [Startup Settings]</i> on page 4-2.
	↓	
	Main Window (Layout 0) Display	Refer to <i>8-2 Adjustment Windows and Run Windows</i> on page 8-11.
	↓	
	Camera Adjustments (Display the settings dialog box for a Camera Image Input processing item.)	Refer to <i>3-1 Preparing the Controller and Cameras</i> on page 3-2.
	↓	
	Select [Tool] – [System settings], and then under [Startup setting], set the settings for [Basic], [Communication], and [Operation mode].	Refer to <i>Section 4 Setting the Controller</i> on page 4-1.
	↓	
	Click the [Data save] button, and then select [Function] – [System restart].	Refer to <i>3-6 Saving Settings before Turning OFF the Power and Restarting</i> on page 3-34.
↓		
Select [Tool] – [System settings], and then set the settings for [Camera], [Communication] and [Other].	Refer to <i>Section 4 Setting the Controller</i> on page 4-1.	
↓		
Click the [Data save] button, and then select [Function] – [System restart].	Refer to <i>3-6 Saving Settings before Turning OFF the Power and Restarting</i> on page 3-34.	

Procedure	Description	Reference
↓		
Scene Editing	In the Main Window (layout 0), edit the measurement flow. <ul style="list-style-type: none"> <li>Register processing items.</li> <li>Set the properties for each processing item.</li> </ul>	Refer to <i>Section 5 Creating Measurement Scenes</i> on page 5-1.
	↓	
	Click the [Data save] button.	Refer to <i>9-2 Saving Settings Data to the Flash Memory</i> on page 9-7.
↓		
Testing	Execute test measurements. (In the Main Window (layout 0), click the [Measure] button.)	Refer to <i>6-1 Executing Test Measurements</i> on page 6-3.
	↓	
	Adjust the parameters for each processing item.	Vision System FH/FHV/FZ5 Series Processing Item Function Reference Manual (Cat. No. Z341)
↓		
	Click the [Data save] button.	Refer to <i>9-2 Saving Settings Data to the Flash Memory</i> on page 9-7.
↓		
Measuring (Operation)	In the Main Window (layout 0), click the [Switch layout] button, and then select [Main Window (Layout 1)].	Refer to <i>Section 6 Performing Measurement and Adjustment</i> on page 6-1.
	↓	
	In the Main Window (layout 1), check the communications with the PLC.	Vision System FH/FHV/FZ5 Series User's Manual for Communications Settings (Cat. No. Z342)
↓		
	In the Main Window (layout 1), execute commands from the PLC, such as measurement trigger commands.	Vision System FH/FHV/FZ5 Series User's Manual for Communications Settings (Cat. No. Z342)
↓		
Management and Analysis	Save and analyze measurement data and images.	Refer to <i>6-5 Analyzing Inspection and Measurement Results [NG Analyzer]</i> on page 6-29. Refer to <i>Section 9 Saving/Loading Data</i> on page 9-1.

# 2

## Features

---

A measurement flow consist of a series of combined processing items and is called a scene. This section explains how to create and edit scenes.

---

<b>2-1 Basic Mechanism for Measurements</b> .....	<b>2-2</b>
<b>2-2 Support for a Variety of Scenes and Measurement Lines</b> .....	<b>2-4</b>

## 2-1 Basic Mechanism for Measurements

An FH/FHV/FZ5-series Sensor Controller uses pre-built packages that contain all the processing tasks (for image input, measurement processing, displays, outputs, etc.) that are required for vision inspections.

You arrange these packaged processes in order of execution of the vision inspection.

An FH/FHV/FZ5-series Controller executes vision inspections according to user-created flows.



### Additional Information

In the FH/FHV/FZ5, a flow that contains packaged processes that are arranged in order of execution of processing items and image processing is called a measurement flow.

Processing items and measurement flows can have more than one setting. You can switch the setting based on the scene to inspect. (Refer to *Section 5 Creating Measurement Scenes*)

### ● Concept of Measurement Processing

When the FH/FHV/FZ5 receives a measurement trigger from the PLC or other external device, the image input from a Camera, measurement processing, and output of measurement results (e.g., OK/NG judgement results) are executed in the order that those processing items are registered in the measurement flow.

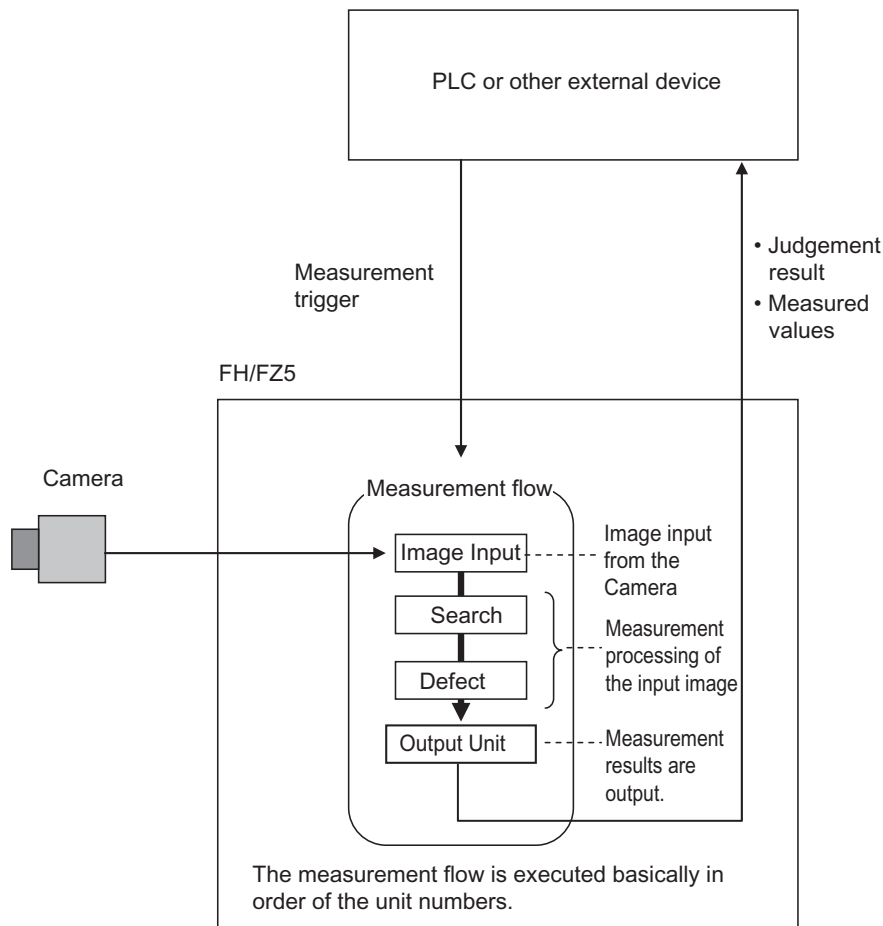

- In the measurement flow, you can change the processing to execute based on the inspection results or input conditions of the vision inspection.
- You can use macro processing to execute pre-packaged processing items and functions in the FH/FHV/FZ5 to create original programs. This allows you to create original measurement processes, dis-



play processing, input and output processing, and settings dialog boxes that are custom-tailored to your application.

## 2-2 Support for a Variety of Scenes and Measurement Lines

You can have more than one setting for a measurement flow, depending on the inspections. This is called a scene and you can set up to 128 scenes. Refer to 5-1 *What Is a Scene?* on page 5-2.

You can also combine more than one scene into a scene group. Management of scenes by scene groups increases the number of scenes that you can handle. Refer to 7-1 *What Is a Scene Group?* on page 7-2.

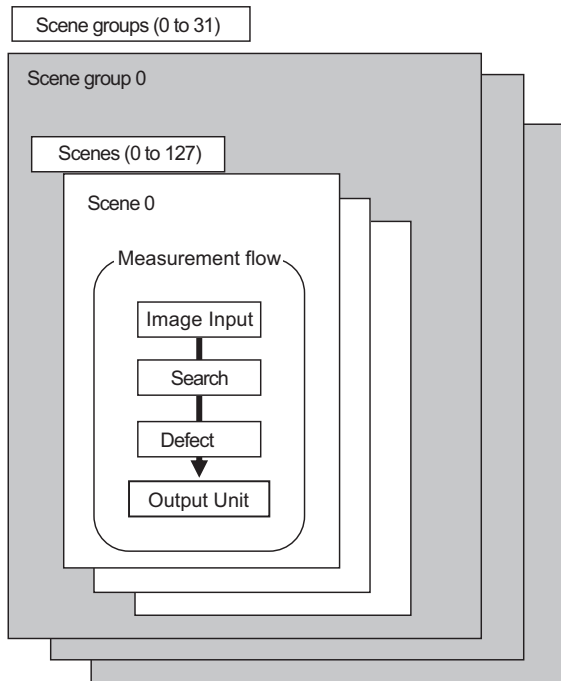

If you have more than one measurement line, the FH allows you to selectively execute up to eight measurement lines. This allows you to maintain settings for the scenes and scene groups for every line from 0 to 7.

You can connect up to eight Cameras to the FH, (four for the FZ5), and selectively control each Camera. Refer to *Multi-line Random-trigger Mode* on page 4-19.

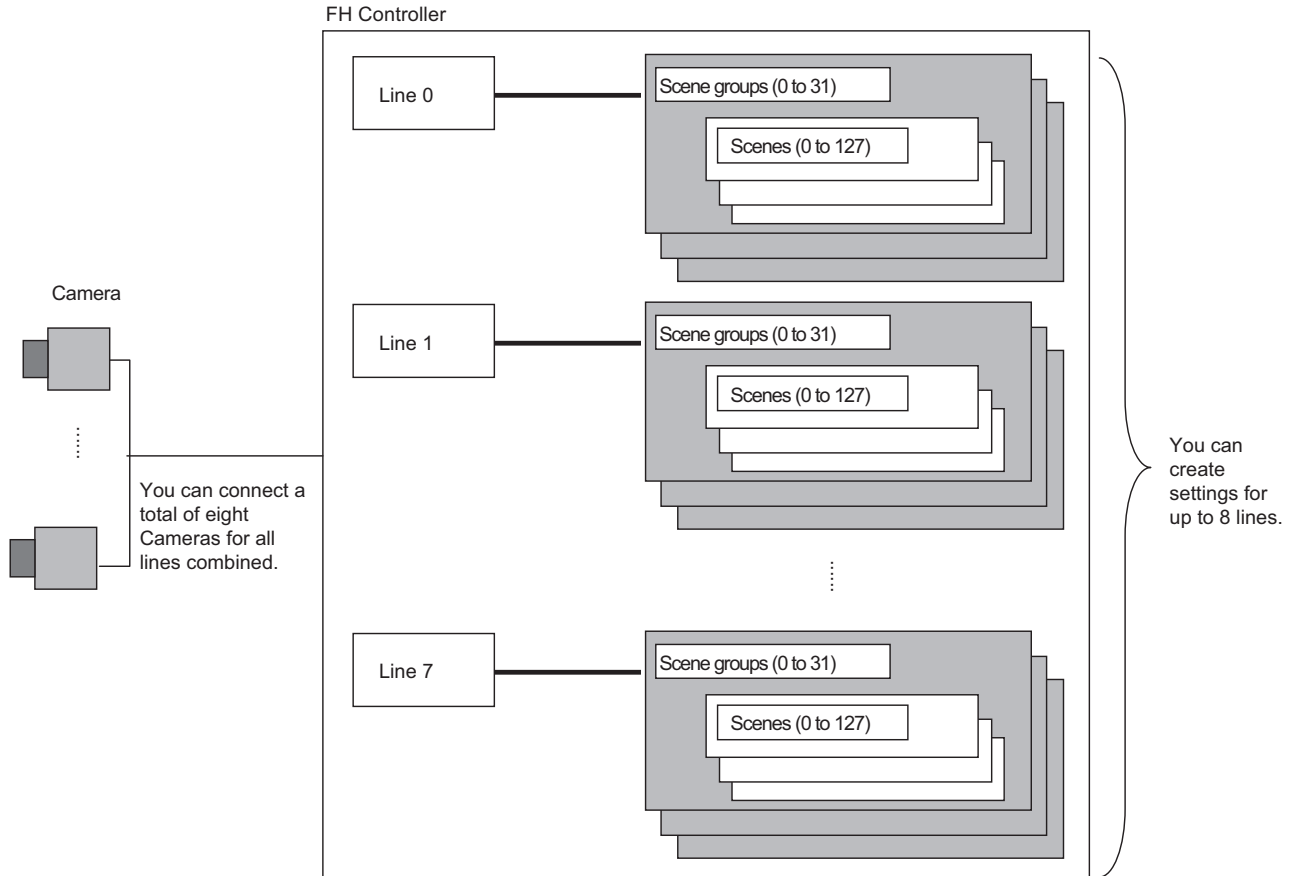



# 3

## Basic Operations

This section describes test methods for checking whether correct measurement can be performed at the set conditions and describes useful functions for operation.

---

<b>3-1</b>	<b>Preparing the Controller and Cameras</b>	<b>3-2</b>
3-1-1	Camera Setup	3-2
3-1-2	Preparing a Controller	3-4
3-1-3	Adjusting the Camera	3-5
<b>3-2</b>	<b>Basic Knowledge about Operations</b>	<b>3-6</b>
3-2-1	Inputting Values	3-6
3-2-2	Inputting Text	3-7
3-2-3	Selecting Files and Folders	3-10
3-2-4	Available Operations in Select File Window	3-13
3-2-5	Using the Zoom Function	3-14
3-2-6	Setting Figures	3-15
3-2-7	Changing the Image Mode and Other Display Contents	3-24
3-2-8	Changing the Display Ratio	3-25
<b>3-3</b>	<b>Checking System Information</b>	<b>3-27</b>
<b>3-4</b>	<b>Checking the Memory Consumption and Percentage of Memory Used</b>	<b>3-31</b>
<b>3-5</b>	<b>Capturing Screen Images</b>	<b>3-32</b>
<b>3-6</b>	<b>Saving Settings before Turning OFF the Power and Restarting</b>	<b>3-34</b>
3-6-1	Saving the Setting to the Controller [Data Save]	3-34
3-6-2	Device Information Storage Tool	3-35
3-6-3	Restarting the Controller: [System Restart]	3-37
<b>3-7</b>	<b>Initializing the Controller</b>	<b>3-39</b>
<b>3-8</b>	<b>Turning OFF the LCD</b>	<b>3-41</b>
3-8-1	Turning OFF the LCD [LCD OFF]	3-41
3-8-2	Restoring Power to the LCD	3-41

## 3-1 Preparing the Controller and Cameras

---

### 3-1-1 Camera Setup

FH series/FZ5 series Sensor Controllers use the CameraLink standard for camera connection. At normal camera connection, a single camera cable is used for a single camera, and each camera is connected to the Sensor Controller in the CameraLink base configuration. Starting from camera connector 0 on the Sensor Controller, connect cameras to the camera connectors you want to use in ascending order of camera connector number.



#### Important

---

- Immediately after starting up the FH series/FZ5 series Sensor Controller and immediately after changing scenes, there will be no input image. No input image is processed as the same color image as in the factory default state.
- If you open the Properties Dialog Box before inputting an image, click the Cancel button to close the dialog box. Pressing the OK button in the dialog box will change the setting to the same color camera setting as the factory default setting.

Refer to *The measurement NG (image mismatch) error will result when connecting a monochrome camera* on page 11-11.

---

## Using Two Cables for High-frame-rate Camera Use (FH series only)

FH series Sensor Controllers support the CameraLink standard's Base Configuration and Medium Configuration.

The Medium Configuration enables use at a higher frame rate than the Base Configuration, reducing image input time. The configuration that can be connected will depend on the connected cameras. See the instruction sheet of the cameras you are using.

To connect a camera in the Medium Configuration, you will need to use two camera cables of the same type and length to connect the camera and Sensor Controller (two-cable connection).

Sensor Controller camera connectors should be connected as a pair with ascending consecutive even and odd numbered connectors.

The table below shows the camera connector and camera number assignments when connecting the Sensor Controller and camera cable with a two-cable connection.

### ● Camera numbers for operation modes other than multi-line random trigger mode

The table below shows the camera connector and camera number assignments when the operation mode is a mode other than the multi-line random trigger mode.

A number corresponding to a Sensor Controller camera connector number is assigned for the camera number. When using two-cable connection, the even number in the pair of ascending consecutive camera connector numbers is assigned as the camera number.

Sensor Controller camera connector number	Camera number in application software		
	Example when all cameras use one-cable connection	Example when all cameras use two-cable connection	Example when combining one- and two-cable connection
0	0	0	0
1	1		1
2	2	2	2
3	3		
4	4	4	Not connected
5	5		5
6	6	6	6
7	7		

### ● Camera numbers for multiple-line random trigger mode

The table below shows the camera connector and camera number assignments when the operation mode is the multi-line random trigger mode. This table is an example showing the camera number assignments when the number of lines is two.

Camera numbers are assigned for each line in ascending order starting from 0. For two-cable connection, camera numbers are assigned in ascending order regardless of camera connector number pairs.

Sensor Controller camera connector number	Camera number in application software					
	Example when all cameras use one-cable connection		Example when all cameras use two-cable connection		Example when combining one- and two-cable connection	
	Line 0	Line 1	Line 0	Line 1	Line 0	Line 1
0	0	---	0	---	0	---
1	1	---		---	1	---
2	2	---	2	---	2	---
3	3	---		---		---
4	---	0	---	0	---	Not connected
5	---	1	---		---	0

Sensor Controller camera connector number	Camera number in application software					
	Example when all cameras use one-cable connection		Example when all cameras use two-cable connection		Example when combining one- and two-cable connection	
	Line 0	Line 1	Line 0	Line 1	Line 0	Line 1
6	---	2	---	2	---	1
7	---	3				



### Important

- When connecting cameras with two-cable connection, use a pair of ascending consecutive even and odd numbered Sensor Controller camera connector numbers for each camera. You will not be able to get the image acquisitions correctly if you use camera connectors with non-consecutive connector numbers, or if an odd numbered connector has a lower number than the even numbered connector it is paired with.
- CameraLink medium configuration is only supported by FH series Sensor Controller.
- When [Operation mode setting] has been set to the multi-line random trigger mode, changing the camera connections or [Multi-line Random-trigger mode] in the system settings may change camera number assignments in line with the change made. After changing the camera connections or [Multi-line Random-trigger mode], before using the Sensor Controller, check the camera numbers in the property setting screen for the [Camera Image Input] processing items or [Camera Image Input FH] processing items.
- STGOUT signals (STGOUT0 to STGOUT7) signals are tied to the camera connector numbers, not the camera numbers. When using CameraLink Medium Configuration or Multi-line Random-trigger mode, check the camera connector number of a Sensor Controller that corresponds to the camera number.
- SHTOUT signal (SHTOUT0 to SHTOUT7) are tied to the Line number, not camera number. When use Multi-line random-trigger mode, confirm the Line number and use SHTOUT signal.



### Additional Information

When connecting cameras with two-cable connection, the camera connection screen in the system settings displays the camera model for one member of the pair of camera connector numbers, and displays [Disconnect] for the other.

## One-cable Camera Connection

FH series/FZ5 series Sensor Controllers support the CameraLink standard's Base Configuration. In the base configuration, one camera cable is used to connect one camera. Starting from camera connector 0 on the Sensor Controller, connect cameras to the camera connectors you want to use in ascending order of camera connector number.

### 3-1-2 Preparing a Controller

No special preparations are required with this Controller because processing items are pre-installed.

Please check that the Controller is turned On and that the Main Window is displayed.

For details, refer to the *Vision System FH/FZ5 series Hardware Setup Manual (Cat. No. Z366)/FHV Series Smart Camera Setup Manual (Z408)*.

The first time the program is started, the Language Setting Dialog Box is displayed. Select the language.

Refer to 4-1 *Selecting Language [Startup Settings]* on page 4-2.



### 3-1-3 Adjusting the Camera

Check the images that are being taken.

Adjust the position of measurement objects and the focus of the lens.

- 1 Click the upper left corner of the Image Pane, and then select [Image mode] – [▼] – [Through].  
The through image from the Camera is displayed in the Image Pane.  
Refer to 3-2-7 *Changing the Image Mode and Other Display Contents* on page 3-24.
- 2 Adjust the position of measurement objects so that they display at the center of the monitor.

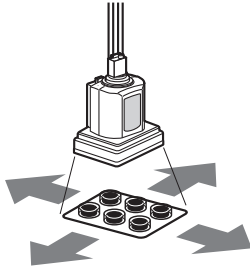

Adjusting the Position of  
the Measurement Target

- 3 Adjust the focal distance of the lens.



#### Additional Information

If a Camera is used together with a lens, turn the focus ring on the lens to adjust the focus.  
Refer to *Lens Adjustment Setting* in the *Vision System FH/FHV/FZ5 Series Processing Item Function Reference Manual* (Cat. No. Z341).



#### Important

When using a Compact Digital Camera, check that the model and serial number of the Camera Head and Camera Amplifier match. When a Camera Head and Camera Amplifier with different models and serial numbers are connected, they may not operate correctly.

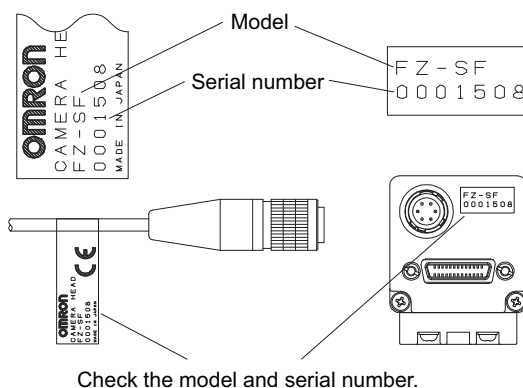

## 3-2 Basic Knowledge about Operations

### 3-2-1 Inputting Values

This section describes how to input values required for setting the judgement conditions and communication specifications. Methods for setting up values include the following, depending on the settings.

- Specify values directly with the numeric keyboard  
Used to enter specific values, or to fine-tune the value with the UP and DOWN keys.
- Set numerical values by dragging the slider  
Setting values can be done by dragging the slider on the screen.

The method for displaying the numeric keyboard and setting values is explained here. For other methods, refer to individual setting descriptions.

- 1 Click [...] in the item in which a value is to be set.  
The numeric keyboard is displayed.



- 2 Click the numeric keys to input values.  
The numerical value is input.  
To fine-tune the value, click the UP or DOWN key to increase or decrease the value.



- 3 Click [OK].  
This verifies the value and closes the numeric keyboard.

## 3-2-2 Inputting Text

This section describes methods for inputting file names and descriptive text.

### Screen keyboard

The following software keyboard is displayed in the window for inputting text depending on the sensor controller.

Switching operation will differ depending on the screen keyboard.

#### ● FH Series Sensor Controller

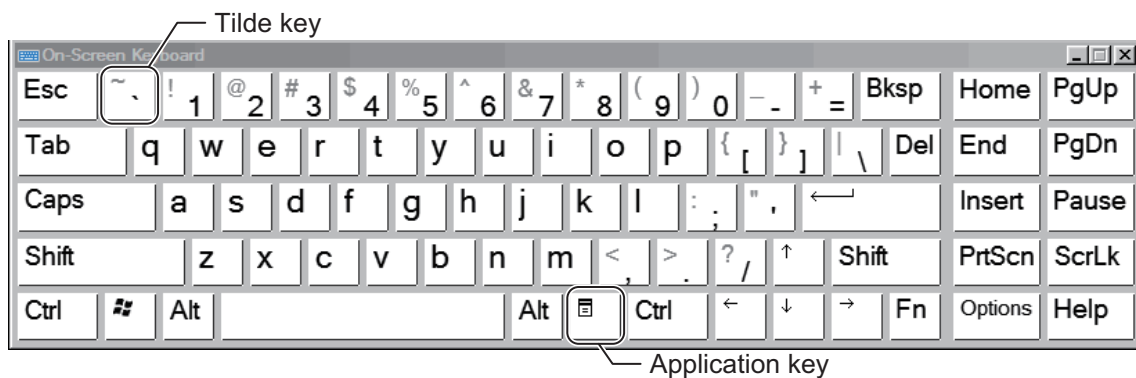

Switch between Japanese (hiragana) input/Japanese (katakana) input/Alphabet-Japanese converted input using the following procedure.

- Use the following procedure to switch between keyboard display languages. The screen keyboard is by default English, with English characters shown on the keys.
  - 1 To change characters displayed on the keys, press [Shift] + [Left Alt].**  
To use the [Shift] + [Left Alt] key combination, first hold down [Shift], and while doing so, press and press again [Left Alt].
  - 2 Display the keys and carry out text input, and confirm the keyboard has been switched.**  
This switches the language.
- Use the following procedure to switch between kana input and alphabet-Japanese converted input. The screen keyboard uses an English keyboard layout, with alphabet-Japanese converted input the default. Switching the keyboard display language to Japanese switches to kana input.
  - 1 To switch between Japanese (katakana) input/Alphabet-Japanese converted input, click [Ctrl] + [Shift] + [Caps].**  
To use the [Ctrl] + [Shift] + [Caps] key combination, first hold down [Ctrl], then hold down [Shift] and press [Caps].  
Then, release [Caps], release [Shift], then release [Ctrl].
  - 2 Display the keys and carry out text input, and confirm the keyboard has been switched.**

- Use the following procedure to switch kana-kanji conversion ON/OFF.  
To input kanji characters, it is necessary to start the IME. There are two ways to do this.

**1 To toggle between IME ON/OFF, press [Alt] + [~] (tilde).**

To use the [Alt] + [~] key combination, first hold down [Alt], and while doing so, press and press again [~].

**2 Alternatively, turn the IME ON by pressing the [Application] key, and from the menu, select [Open IME].**

To turn the IME OFF, press the [Application] key, and from the menu, select [Close IME].



#### Additional Information

- If you connect a keyboard to the Sensor Controller with a USB connection, the key arrangement will be the same as an English keyboard.
- In Japanese, the [¥] (yen) character is used to indicate paths between folders, however if the ¥ character is not shown on the keyboard, then substitute the [ \ ] (backslash) key.

### ● FZ5-1100 series Sensor Controller



Keyboard display languages, switching between kana conversion and alphabet-Japanese conversion, and turning kana-kanji conversion ON/OFF is the same as on the FH series screen keyboard.

### ● FZ5-600 series/FZ5-L series Sensor Controller

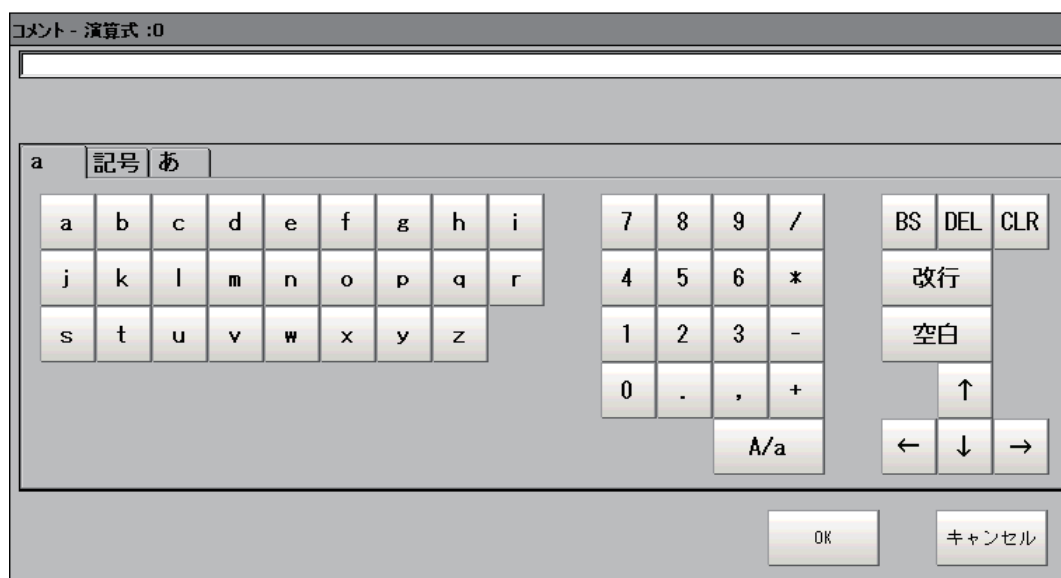

In the FZ5-600 and FZ5-L series sensor controllers, tabs are displayed for each input character type.

## Operation Method

- 1 Click [...] in the item in which a character string is to be set.  
The soft keyboard is displayed.



- 2 Switch the tabs as needed and Click the character that is to be input.

Depending on the used languages settings (Refer to 4-1 *Selecting Language [Startup Settings]* on page 4-2 in order to switch display languages, input characters using the following format.

After the language identifier surrounded by single-byte ¥ (yen) or single-byte \ (backslash) symbols, detail the character to input.

Example: if the used language setting is Japanese, then [ 入力文字 ] will be displayed, and if this is English, then [input character] will be displayed.

-----  
¥jpn¥ 入力文字 ¥eng¥input character

or

\jpn\ 入力文字 \eng\input character  
-----

Language identifiers:

jpn: Japanese

eng: English

chs: Simplified Chinese

cht: Traditional Chinese

deu: German

fra: French

ita: Italian

esp: Spanish

kor: Korean

vnm: Vietnamese

pol: Polish



### Important

- If a character string for the currently used language is not set, then English (eng) character strings will be used.
- If a character string for the currently used language as well as one that supports English is not set, then the input character string will be displayed as is.



### Additional Information

- FH series sensor controller and the FZ5-1100 series sensor controller support 9 languages (Japanese/English/simplified Chinese/traditional Chinese/German/French/Italian/Spanish/Korean).
- FZ5-L series sensor controller and the FZ5-600 series sensor controller support 4 languages (Japanese/English/simplified Chinese/traditional Chinese). (Refer to 1-1-2 *Functional Comparison between the FH-series, FHV-series and FZ5-series Controllers* on page 1-3)

- 3 Click [OK] after text has been entered.  
The software keyboard is closed.

### 3-2-3 Selecting Files and Folders

This section describes data save/load methods and operation methods for when selecting a save destination folder for images created during remeasurement, etc.

The following window will appear in the window to select a file or a folder.

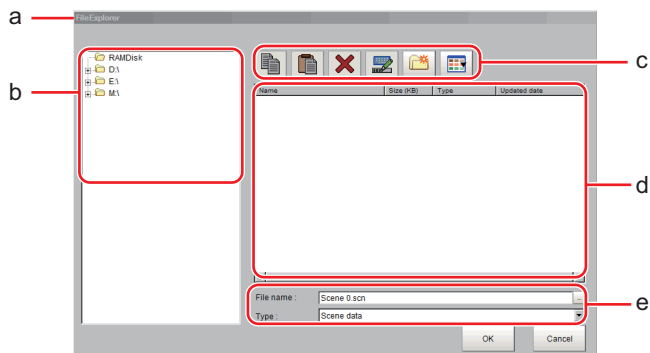

(a) Window Title

When a file is specified, "File Explorer" is displayed. If a folder is selected, "Select folder" is displayed.

(b) Folder View Area

A list of folders on the RAMDisk and folders in the mounted the external storage is displayed. At the root of the tree, the drive names of all accessible the external storage devices are displayed (ex. "USBdisk", "USBdisk2").

(c) Toolbar

-  Copy

Refer to *Copying/Pasting a File or Folder* on page 3-13.

-  Paste

Refer to *Copying/Pasting a File or Folder* on page 3-13.

-  Delete

Refer to *Deleting a Folder or File* on page 3-13.

-  Rename

Refer to *Renaming a Folder or a File* on page 3-13.

-  New folder

Creates a new folder.

-  Toggle list view

Switches the display format of the List View area.

## (d) List View Area

A list of files and folders contained in the folder selected from the folder view area is displayed. In addition, when an extension name is selected from "Kind", only the files with the selected extension name are displayed. The content displayed is switched if [List display toggle] () is clicked.

## (e) File Name View Area

- File name  
Names of files selected in the List View area are displayed.
- Kind  
Specifies the types of the file displayed ("Scene data", "System data", etc.) in the List View area.

Note that selection method of BMP(BFZ) file/JPG(JFZ) file type differs.

(Refer to 6-3-1 Logging Measurement Values and Measurement Images [Data Logging/Image Logging] on page 6-8,  
Refer to A-6 Image file on page A-20.)

### ● BMP(BFZ) file selection in FileExplorer

BMP(BFZ) file type is a file type included in image file types. Therefore, note that when selecting BMP(BFZ) file type in FileExplorer, the displayed contents may differ.

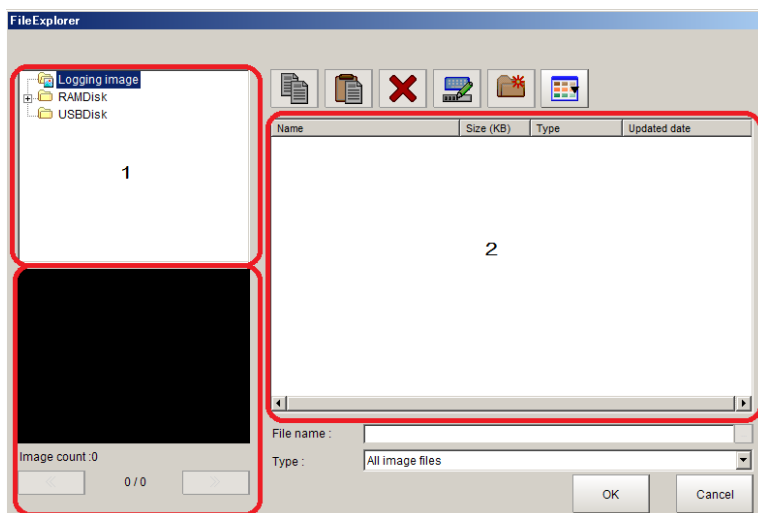

When you select BMP(BFZ) file type on the 1 area.

- (1) Selecting BFZ file type in FileExplore, it is processed as a folder. BFZ file type cannot be selected as a measurement object.
- (2) If multiple images are saved to selected BFZ file, saved image will display on file select window.

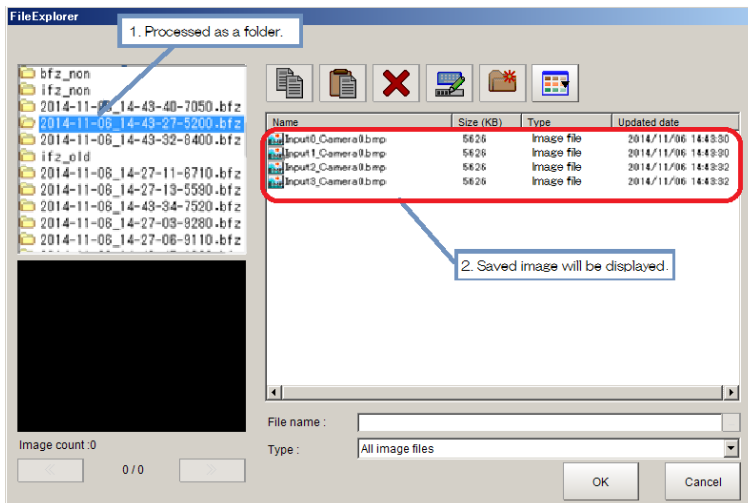

When you select BMP(BFZ) file type on the 2 area.

- (1) Selecting BFZ file type in FileExplore, it is processed as a file. In this case, those files are processed same as a measurement object file.
- (2) If multiple images are saved to selected BFZ file, saved image will display on the left-lower window (under part of 1). Clicking [<<] and [>>] buttons, image change is applied.

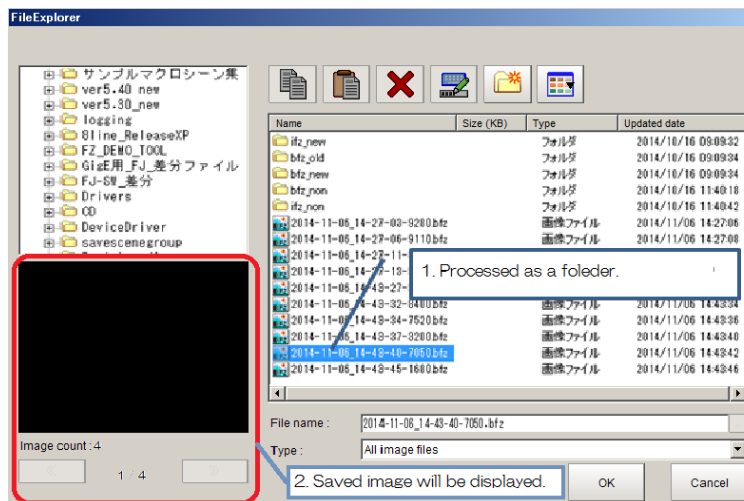



### 3-2-4 Available Operations in Select File Window



This section describes the main operations available from the Select File window.



#### Additional Information

If the target file is not displayed in the list view area when selecting a file, please check that the file type of the target file is selected in "Kind".

### Copying/Pasting a File or Folder

- 1** Click the folder or file that you want to copy in the List View area.  
The file or folder will be selected.
- 2** Click [Copy] (  ).
- 3** Select the target folder, and Click [Paste] (  ).

### Renaming a Folder or a File

- 1** Click the name of file or folder to be renamed from the List View area.  
The file or folder will be selected.
- 2** Click [Rename] (  ).  
The soft keyboard is displayed.
- 3** Enter a new name.  
Character input method: Refer to 3-2-2 *Inputting Text* on page 3-7



#### Additional Information

When a file or folder with the same name exists within the folder, an error message will display telling you that you cannot change the name.

### Deleting a Folder or File

- 1** Click the name of file or folder to be deleted from the List View area.  
The file or folder will be selected.
- 2** Click [Delete] (  ).  
A confirmation window is displayed.
- 3** Click [OK].  
The selected file or folder will be deleted.

### 3-2-5 Using the Zoom Function

You can adjust the window scaling for the image display on the image display area of Properties Dialog Box.

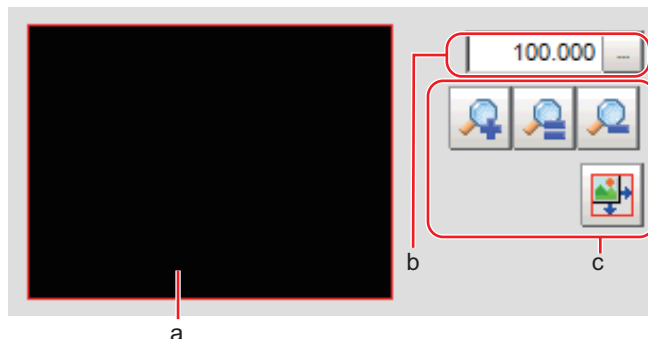

(a) Zoom browser

Indicates where the zoom display area is in the original image.

(b) Magnification factor

Input the magnification factor A factor of between 25% to 1600% can be indicated.

(c) Operation buttons

-  Zoom-in button

Enlarges the selected area to twice its size.

-  Original size button

Displays the selected area in the original size.

-  Zoom-out button

Reduces the selected area by half.

-  Full-screen button

Enlarges the zoom browser to the entire screen and returns it to its original size.



#### Additional Information

You can use the Zoom function using your mouse wheel on the image display area in FH series/FZ5-800 series/FZ5-1100 series/FZ5-1200 series.

### 3-2-6 Setting Figures

This section describes the setting method for objects (figures and text) when you register Model or set the measurement region on the Properties Dialog Box of Processing units.

The type and number of objects varies depending on different setting options.

#### Layout of Figure Setting Area

Window for registering figures when registering or setting areas or models as measurement objects.

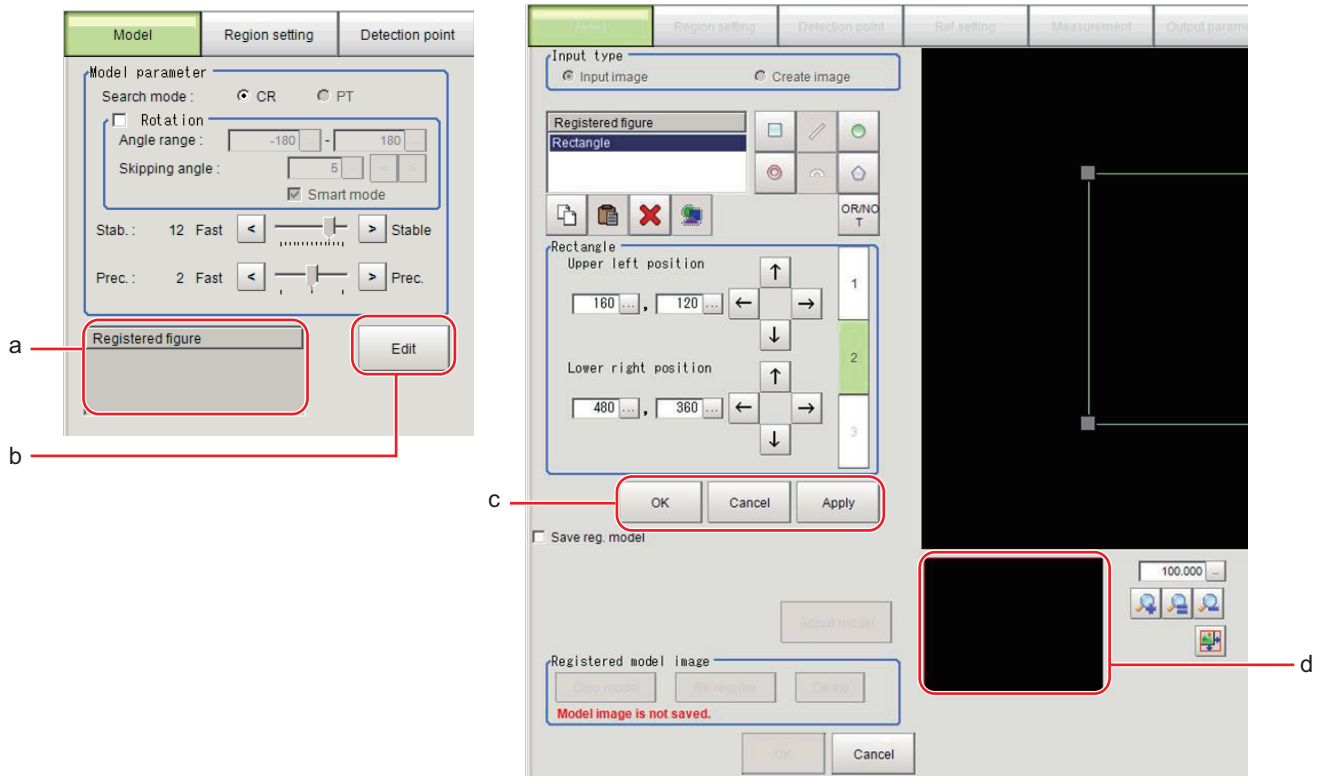

#### (a) Figures

Displays a list of names of registered objects on the Properties Dialog Box when related figures are set. The figure at the bottom of the list is the nearest object in the foreground. The higher the sequence position of the object, the further back in the background it is. When objects are drawn overlapping, the settings for the object set last are valid.

(b) [Edit]

You can edit on the Properties Dialog Box when related figures are set. By clicking [Edit] button, the following figure editing tool will be displayed.

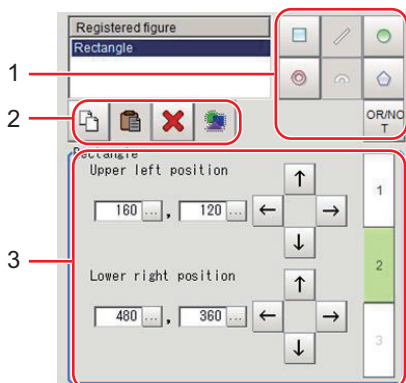

(1) Drawing tool buttons

Sets up objects, such as figures and text. The number and type of objects available is different depending on the applicable setting (ex. "Result display", "Model", "Region setting").

(2) Object editing buttons

Buttons for editing objects

(3) Details

Shows the details of the selected figure. Specify the object coordinates or radius. Tapping [▲] or [▼] will display the items currently not displayed.

(c) Each buttons

These button are displayed under the figure editing tools.

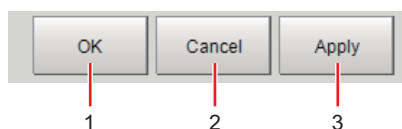

(1) [OK]

The Model is registered. Returns to the previous menu.

(2) [Cancel]

Changes are discarded. Returns to the previous menu.

(3) [Apply]

Updates the figure without leaving edit window.

(d) Zoom Browser Area

Magnifies the Image Display area by the selected magnification factor.

Refer to 3-2-5 *Using the Zoom Function* on page 3-14.

## Setting Methods

### ● Rectangle

- Image selection status

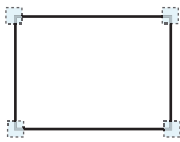

Points are displayed at each of the four corners.

- Dimension Adjustment

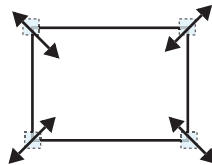

- Example) When enlarging

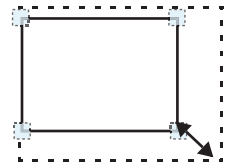

Drag the lower right point down in a diagonal direction.

- Using numbers for setting

The setting area consists of two windows below. Click the [1] or [2] on the right side of the window to select the setting item.

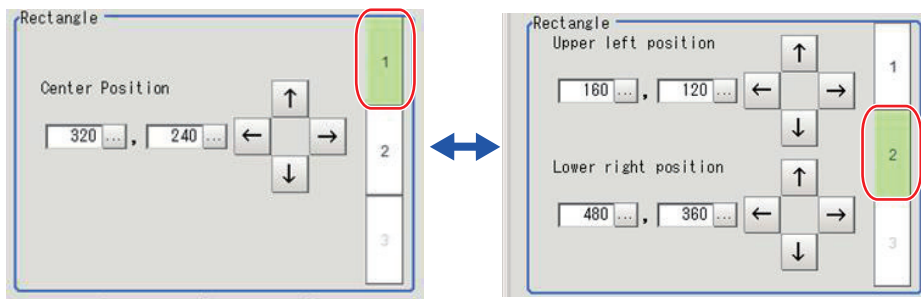

### ● Line

- Image selection status



Points are displayed at the starting point, ending point, and mid point of lines.

- Dimension Adjustment



- Example) When changing the length of a line

Drag the points toward the intended direction.



- Example) When changing the oblique direction

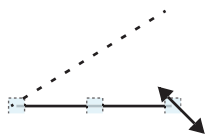

Drag a point in the direction the line is to be changed.

- Example) When changing the line width

Drag the center point of the line in a direction perpendicular to the line.



- Using numbers for setting

The setting area consists of two windows below. Click the [1] or [2] on the right side of the window to select the setting item.

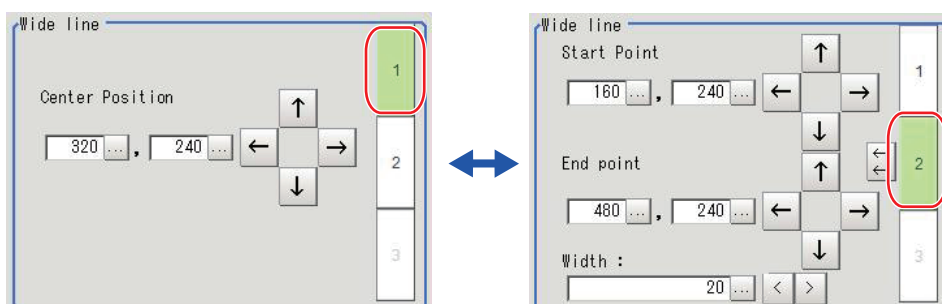

● Circle/Ellipse

- Image selection status

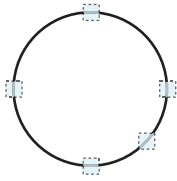

Points are displayed on the top, bottom, left, right, and lower right of the circle.

- Example) When zooming in on a circle  
Drag the point on the lower right of the circle.

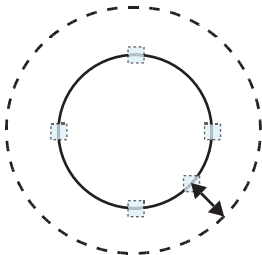

- Dimension Adjustment

Drag the points.

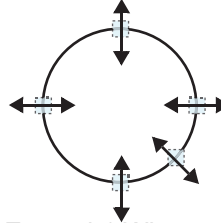

- Example) When transforming a circle into a long horizontal ellipse  
Drag the point on the right of the circle to the right.

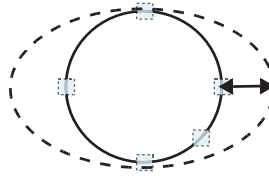

- Using numbers for setting

The setting area consists of two windows below. Click the [1] or [2] on the right side of the window to select the setting item.

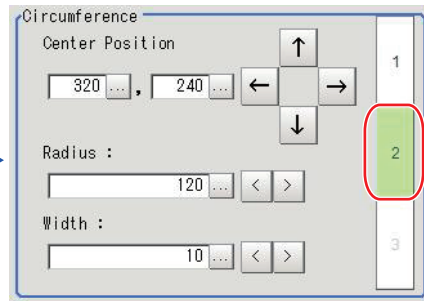
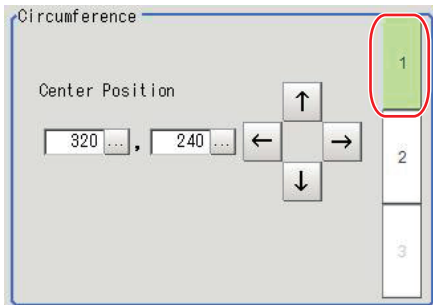

● **Circumference**

- Image selection status

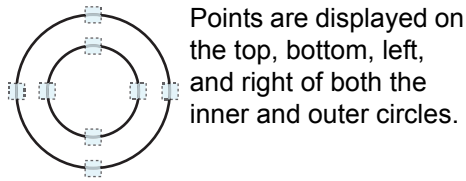

- Dimension Adjustment

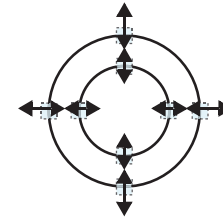

- Example) When enlarging the entire circumference

Drag a point on the outer circle.

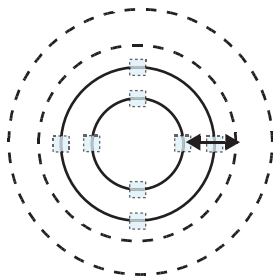

- Example) When adjusting the width of the circumference

Drag a point on the inner circle.

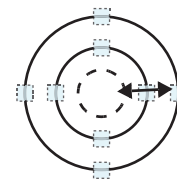

- Using numbers for setting

The setting area consists of two windows below. Click the [1] or [2] on the right side of the window to select the setting item.

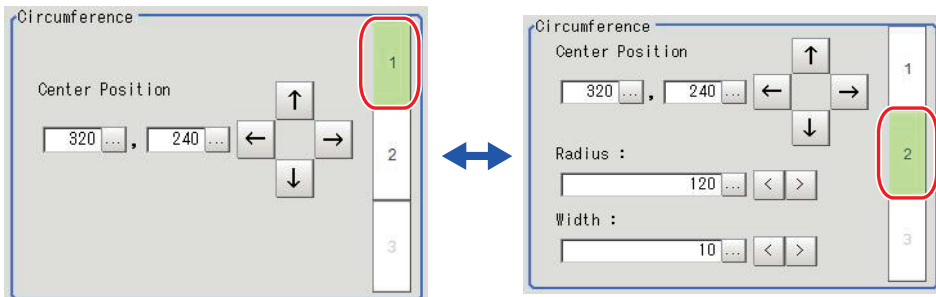

● Arc

- Image selection status

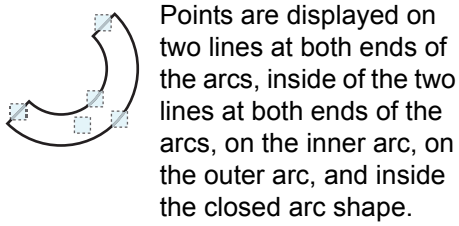

- Dimension Adjustment

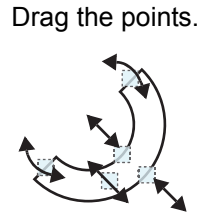

- Ex.) When enlarging an arc  
Drag the point inside the arc outward.

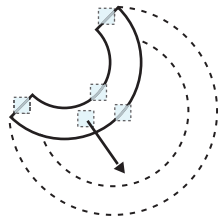

- Ex.) When adjusting the width of an arc  
Drag a point on the inner or outer arc inward or outward.

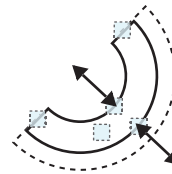

- Ex.) When changing the angle of arc (part that is open)  
Drag one of the points inside of the two lines at both ends of the arcs.

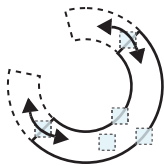

- Using numbers for setting

The setting area consists of three windows below. Click the [1], [2], or [3] on the right side of the window to select the setting item.

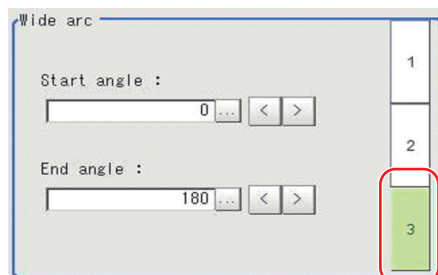
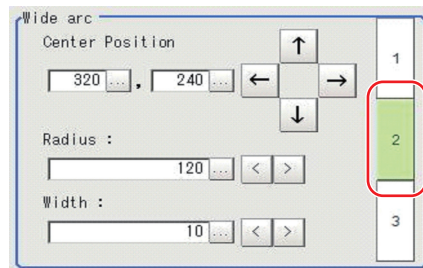
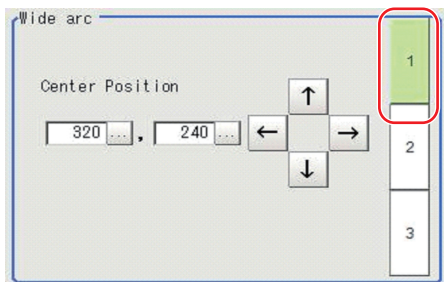



● **Crosshair Cursor**

- Image selection status



Entire image is selected.

- Using numbers for setting

Setting is performed through input of numbers or through tapping on the arrows. The line type and line color can also be changed at this window.

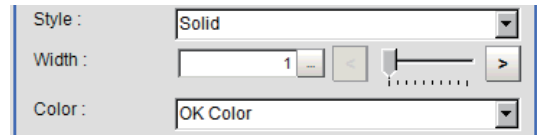
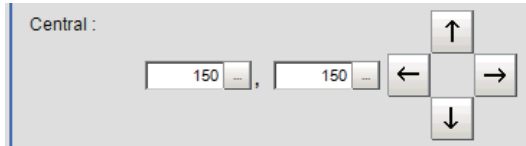

● **Polygons (Triangle to Decagon)**

- Drawing methods (for drawing a quadrilateral)

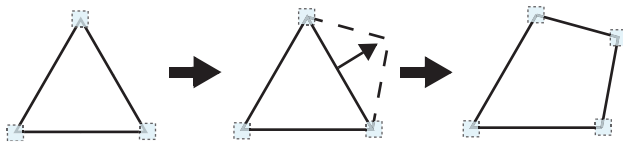

**1** When [Polygon] is specified, a triangle is drawn at first.

**2** If you drag and drop one of the sides at the point you want to make a new vertex, a new vertex will be created.

If the number of vertices is not within 3 to 10, the image cannot be confirmed as a polygon.

- Image selection status

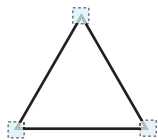

Point is displayed at vertex of figure.

- Example) When changing the angle of one point Drag points (arbitrarily).

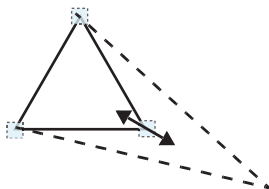

- Dimension Adjustment

Drag the points.

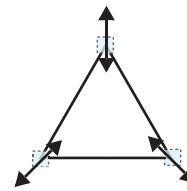

- Example) When changing the region Drag points (arbitrarily).

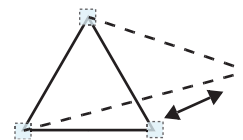

- Using numbers for setting

The setting area consists of two windows below. Click the [1] or [2] on the right side of the window to select the setting item.

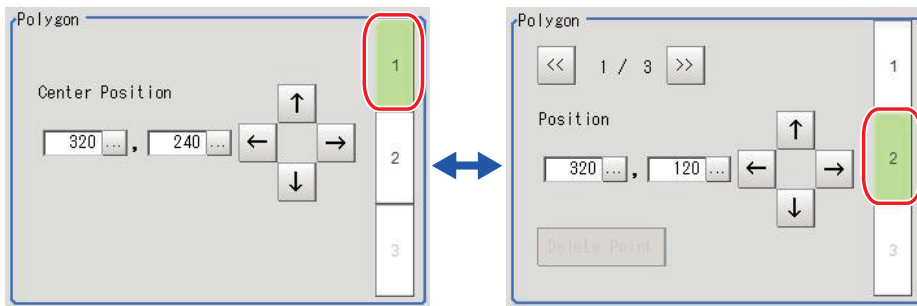

#### ● Text

- Image selection status

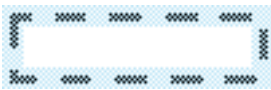

Entire image is selected.



#### Additional Information

- "Text" can only be used in the [Result display] processing item.

#### ● Time

- Image selection status

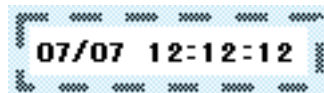

Entire image is selected.



#### Additional Information

- "Time" can only be used in the [Result display] processing item.

## About OR Setting/NOT Setting

The OR setting/NOT setting is used when multiple images are combined.

Areas with complex shapes can be drawn through combining figures, and unnecessary parts can be excluded from the area. Each time [OR/NOT] (  ) is tapped, the setting of the selected figure toggles between OR and NOT.



### Important

- Images with only the NOT setting cannot be drawn.
- For regions where two or more graphics are overlapped, the latest NOT/OR setting overrides the earlier settings.

Item	Description
OR/NOT (  )	Used when drawing a model or a region Switching between OR and NOT occurs each time the button is tapped.
OR	The selected figure is displayed with a dotted line in an OK color. When drawing multiple figures, the entire area is registered as one region.
NOT	The selected figure is displayed with a dotted line in an NG color. The area outside of the NOT image is registered as a region.

(Example) The grey parts are measurement regions.

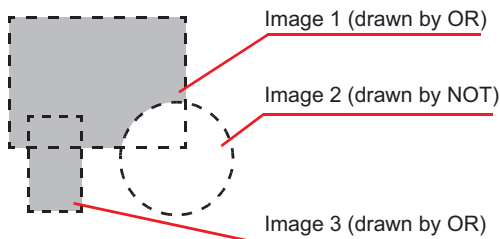

### 3-2-7 Changing the Image Mode and Other Display Contents

The display contents of the Image Pane can be changed in order to make the measurement status easier to understand.

- 1 Click the upper left corner of the Image Pane that for which to change to display the settings dialog box for the Image Pane.

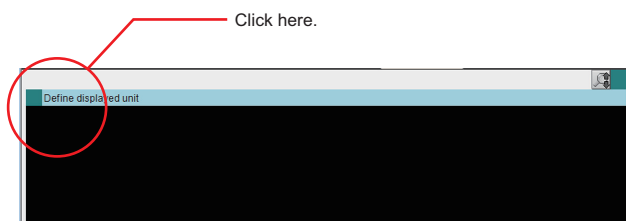

- 2 The settings dialog box for the Image Pane is displayed. Set the items.

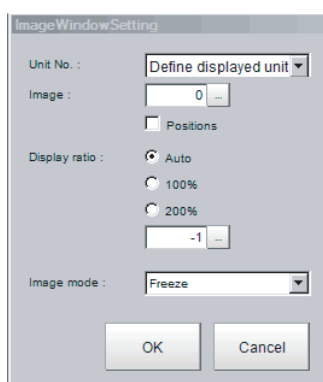

Setting item	Setting value [Factory default]	Description
Unit No.	<ul style="list-style-type: none"> <li>• [Define displayed unit]</li> <li>• Processing unit in the flow</li> </ul>	<p>If the [Define displayed unit] option is selected, the measurement image for the selected unit in the flow display is displayed. If you select another unit in the flow display, the measurement image that is displayed will also change according to the selected unit. If the flow display is hidden, current settings for the flow display will be maintained.</p> <p>If you specify a unit number, the measurement image will continue to display the image for that unit number, regardless of the selected unit in the flow display.</p>
Image	[0] to 100	Specify a sub image number for the measurement image to display. The sub image number that can be displayed depends on the processing item. The menu is disabled if the [Position] is checked.
Position	<ul style="list-style-type: none"> <li>• [Unchecked]</li> <li>• Checked</li> </ul>	Specify whether to display the position list.
Display ratio	<ul style="list-style-type: none"> <li>• [Auto]</li> <li>• 100%</li> <li>• 200%</li> </ul> Value: -1 to 1,600	Specify the magnification at which to display the Image Pane.
Image mode	<ul style="list-style-type: none"> <li>• Through</li> <li>• [Freeze]</li> <li>• Last NG</li> </ul>	Specify the image mode to use to display the image in the Image Pane.

### 3-2-8 Changing the Display Ratio

When you use the FH series/ FZ5-1100 series, you can change the display magnification as follows:

- 1 Click the zoom icon in the upper right corner of the Image container window.



- 2 The zoom icon color is changed, and then the Display Ratio can be changed by using mouse wheel.

Change the display magnification at the position of the mouse pointer.



The Display Ratio can be changed by using mouse wheel.



The Display Ratio can not be changed by using mouse wheel.



#### Additional Information

If there is a display magnification via mouse wheel capability, the following operation is usable.

- Double-clicking:  
Change the doubled display magnification to fit the image widow size.
- Triple-clicking:  
Displays the part of the window except the partially loaded margin.  
Change the display magnification of the captured image except the margin according to the window size.

### Image Mode List

You can change the following items on the Main Window (layout 0).

Item	Description
Through	The latest image is always loaded from the Camera and displayed. When a through image is selected, saved images cannot be called up for measurement.
Freeze (default)	The image that was scanned in the immediately preceding measurement is displayed. Images are updated when measurements are performed.
Last NG	The latest NG error image resulting from an overall judgement is displayed. The latest measurement results are always shown in the overall judgement and measurement time. In this case, the overall judgement result and measurement time may conflict with the Camera image. Also, during continuous measurements, the last NG image cannot be displayed.



#### Important

- In the following cases, saved images cannot be called up for measurement.  
When a through image mode is selected in unused Image pane.
- When you select [Through], the measurement start or display switch may be delayed.



### Additional Information

---

- If a measurement trigger is input while using the multi-input function or immediately after BUSY is turned OFF (such as while the display is being updated), the last NG image cannot be displayed.
- [Display Last NG Image] serves a similar function as a processing item for which error images can be saved. If this processing item is used, the last NG image can be acquired without operation having any effect on operation.
- The icon in upper right of the Image Pane shows current state of the image.

The  icon shows "Through" of image mode.

The  icon shows "Last NG" of image mode.

---

## 3-3 Checking System Information

The Controller model and measurement application version can be checked.

You can check the external storage status only on the FH series and the FZ5-800/1100/1200 series.

Refer to 9-1-3 *Using External Storage Devices* on page 9-6.

Additionally, you can use a Firmware upgrade tool. Make sure to contact your OMRON representative.



### Additional Information

Firmware upgrade tool is a software used when changing the version of the measurement application soft. For the update, need a USB memory or SD memory card to save the data.

- 1 In the Main Window, select [System information] from the [Function] menu.  
The [System information] dialog box is displayed.

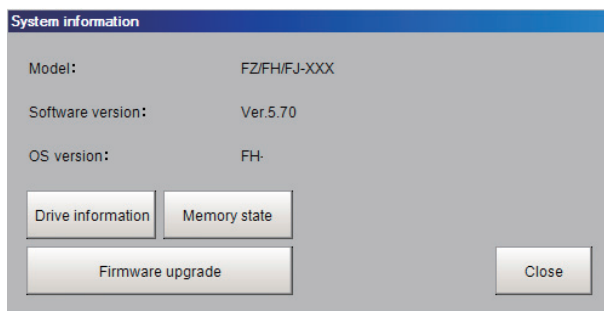

- 2 The following information can be checked.  
Sensor Controller model, Version of measurement application, OS version of Sensor Controller



### Additional Information

When executed from the FZ\_FH Remote Operation Tool, you can check the information of both the controller and the remote operation tool.

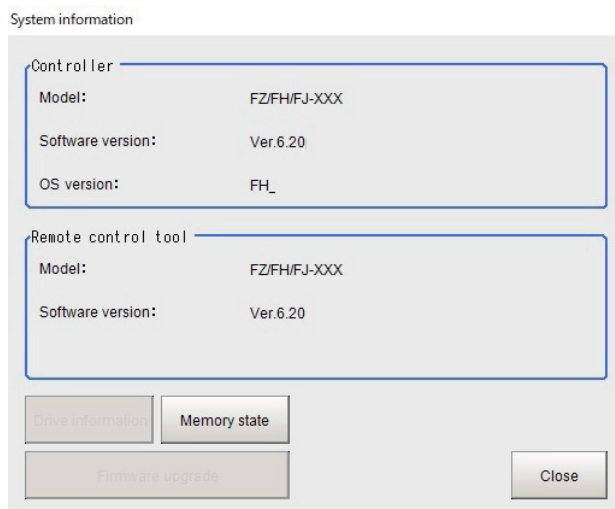

● **About [Drive information] button**

**1** Click the [Drive information] button.

The information of the drive that is connected to the Sensor Controller is can be checked.

Refer to 9-1-2 *External Drive Names* on page 9-5 and 9-1-3 *Using External Storage Devices* on page 9-6.

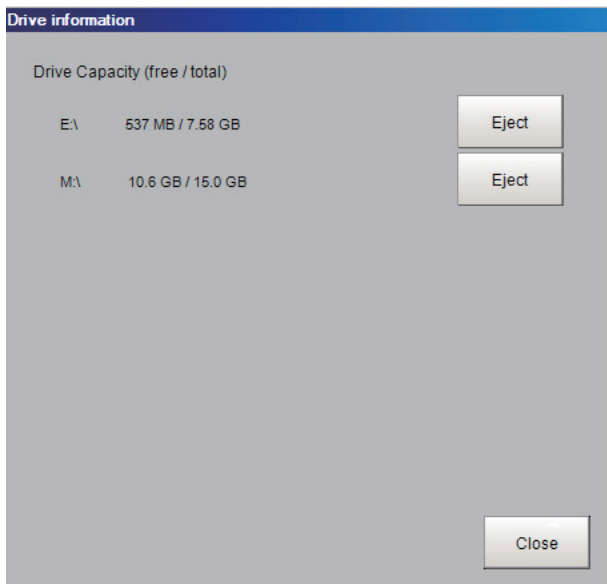

**2** Click the [Close] button.

The Drive information window will be closed.

● **About [Memory state] button**

**1** Click the [Memory state] button.

Below information is displayed.

FH series/FZ5-800/1100/1200 series

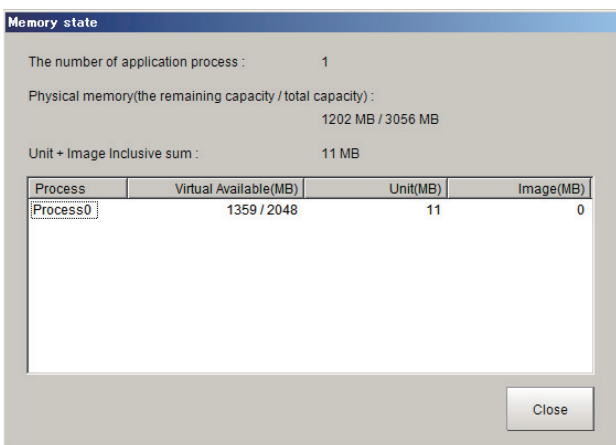

FZ5-L series/FZ5-600 series

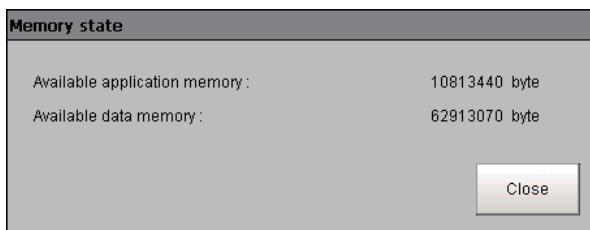



Displayed item	Description
The number of application process	Differs depending on the Sensor Controller mode. Refer to <i>4-4 Setting Operation Mode [Startup Settings]</i> on page 4-12. Standard = 1 Double Speed Multi-input = 2 Non-stop adjustment = 2 (Operation: Process 0, Adjustment: Process 1) Multi line random trigger mode = Number of set lines (Each line number corresponds to the process number).
Physical memory (the remaining capacity/ total capacity)	The remaining capacity and total capacity of the Physical memory installed in the Sensor Controller.
Unit + Image Inclusive sum	Total size of unit that is held by the scene group loaded to the Sensor Controller and image data.
Virtual Available (MB)	Amount of virtual memory usable. 2GB is applied to each application process. This memory region can be temporary used by application process. If you check the remaining capacity, you can confirm the operating status. Users can not access to this memory.
Unit (MB)	Total data size of the units held by Scene groups that are loaded to the Sensor Controller.
Image (MB)	Total data size of the image data held by Scene groups that are loaded to the Sensor Controller.
Available application memory	Item displayed with FZ5-L series and FZ5-600 series. This is a memory region temporary used for the application. If you check the remaining capacity, you can confirm the operating status. Users can not access to this memory.
Available data memory	Item displayed with FZ5-L series and FZ5-600 series. Available data memory represents the memory capacity which can be used for unit data and setting data for each unit out of the memory for Scene group data. If the data memory used exceeds this, it becomes impossible to add units in the flow and copy the scenes. Check the available data memory and modify the scenes.

- Click the [Close] button.  
Memory state window will be closed.



**Additional Information**

With FH series and FZ5-800/1100/1200 series, when the amount of memory used in the Sensor Controller exceeds a certain level, below warning message dialog will be displayed.

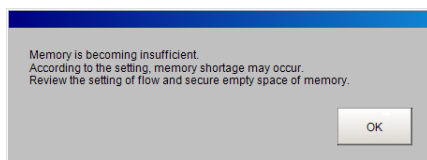

If this dialog is displayed, check the memory status and take the following measures to enlarge the Virtual Available (MB).

Status	Countermeasures
Unit value it too large.	Modify the Scenes and reduce the number of processing items. Or split the Scene group.

Status	Countermeasures
Image value is too large.	Modify the Scenes and reduce the filter units. Replace some filtering processing into one advanced filter. Or lower the camera resolution.



### Additional Information

The Memory state window can be displayed from Measurement Manager Bar, as well as taking above steps starting from System information.  
 Refer to *3-4 Checking the Memory Consumption and Percentage of Memory Used* on page 3-31.

### ● Regarding [Firmware upgrade] button

Click the [Firmware upgrade] button only when launch the Firmware upgrade tool.

Do not click it except when launch this tool.

If you accidentally click [Firmware upgrade] button, a dialog which informs you need to end the tool. In this case, click [Cancel], and then back to a window to confirm the system information.

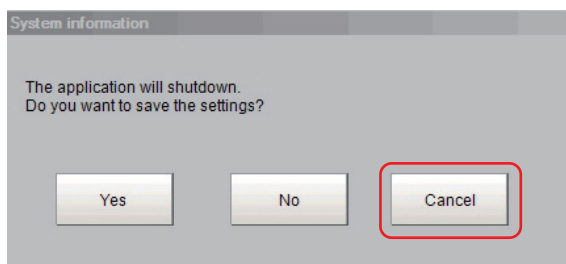

### Important

If you click the [Firmware upgrade] button without insert external storage which saved data of Firmware upgrade tool, a dialog appears indicates you should end the measurement application.

When [Yes] or [No] are clicked, the measurement application finishes.

When you want to re-launch the measurement application, turn OFF the power source once, and then turns ON.

## 3-4 Checking the Memory Consumption and Percentage of Memory Used

The Memory state window that shows the memory used in the sensor controller can be opened from the Measurement Manager Bar.

- 1 Click the [M] button on the Measurement Manager Bar of the Main Window.

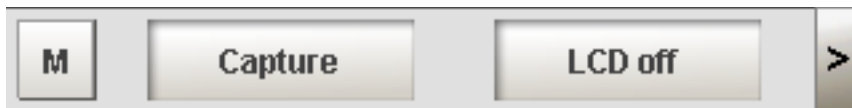

- 2 The Memory state window is displayed. You can check the amount of memory used. For details of the Memory state window, refer to the following. Refer to 3-3 *Checking System Information* on page 3-27.

FH series/FZ5-800/1100/1200 series

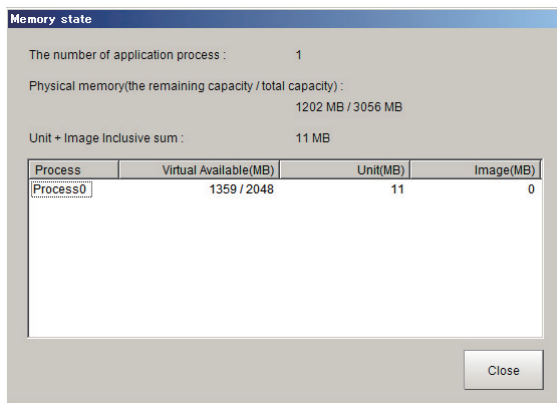

FZ5-L series/FZ5-600 series

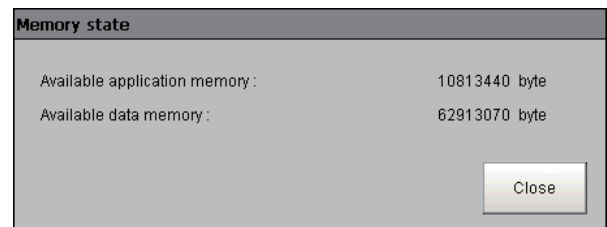

### Additional Information

If the amount of used memory increases and the amount of free memory becomes insufficient, it may cause errors in operation mode switching or in adding Processing Units into the measurement flow. Please check the memory consumption when you create scenes. Refer to 3-3 *Checking System Information* on page 3-27.

## 3-5 Capturing Screen Images

---

The contents displayed in the run window can be captured. Saved images can be loaded into the computer and pasted into documents.

### Set the Destination for Captured Images

---

Use the following procedure to set the save destination for the image captured with the screen capture function.

- 1** In the Main Window, select [System settings] – [Other] – [Screen capture setting] from the [Tool] menu.

The [Screen capture] settings dialog box is displayed.

- 2** Specify the save destination for captured images.



- 3** Click [Apply].

## Saving Captured Images

- 1 Click the [Capture] button that is displayed on the Measurement Manager Bar that is located in the bottom right corner.

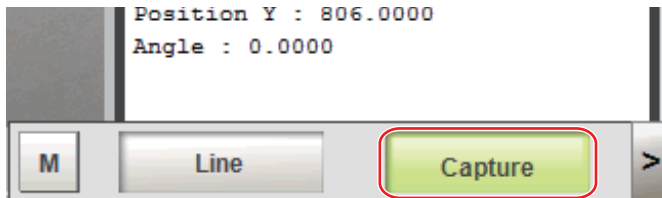

### Important

The capture takes a few seconds and measurement cannot be performed during that time period.



### Additional Information

- An alternative operation is to select [Screen capture] from the [Function] menu.
- When you use the [Capture] button that is located in the bottom right corner to capture the screen image in Multi-line Random-trigger Mode, the image is always saved to the destination that is set for line 0.

## ● Captured Image Files

This section explains the format and file names for captured images.

Item	Description
File format	The file format is BMP.
File name	The file name is the date and time at which the capture was performed. YYYY-MM-DD_HH-MM-SS-MS.BMP Year (4 digits) -Month- Date_ Hour- Minute- Second- Millisecond Example: The file name for a capture date and time of 3/10/2007, 11:25:30.500: 2007-03-10_11-25-30-500.BMP



### Additional Information

The following cannot be captured.

- The dialog box to select a file or a folder
- Confirmation message when LCD is turned OFF

## 3-6 Saving Settings before Turning OFF the Power and Restarting

### 3-6-1 Saving the Setting to the Controller [Data Save]

Before you turn OFF the power supply to the Controller, save the data that you have set to the flash memory in the Controller.

The settings data in the flash memory of the Controller are loaded everytime the Controller is restarted, so make sure to use the [Data save] command to save the settings data to the flash memory in the Controller. Then, always restart the Controller. The settings data will not take effect unless you restart the Controller. If you do not save the data to the flash memory in the Controller, changes to the settings will be lost when you turn OFF the power supply.

- 1 In the Main Window (layout 0), click the [Data save] button in the Toolbox Pane to save the settings data.



- 2 Turn OFF the power supply to the Controller and exit the system.



#### Additional Information

- **Data That Is Saved**  
Scene data and system data are saved in the Controller. Logged images and data that are saved in the RAM disk are not saved. Perform any of the following procedures to keep this data.
  - **Copying Data Saved in the RAM disk to External Storage**  
Refer to *9-5 Copying or Moving Files between the Controller RAMDisk and an External Storage Device* on page 9-12.
  - **Changing the Save Destination for Logged Data to External Storage**  
Refer to *6-3-1 Logging Measurement Values and Measurement Images [Data Logging/Image Logging]* on page 6-8.
- **Using the Scene Group Function**  
The scene data that is set for scene group 0 is saved in the Controller for models FZ5-L series and FZ5-600 series. The scene data from scene groups 1 to 31 is saved to the external storage and overwrites any previously saved data. (For the FH series or FZ5-800/1100/1200 series, all data is saved in the Controller by default.)

## 3-6-2 Device Information Storage Tool

This tool will prevent issues happening at start-up of the Sensor Controller due to recognition delay for external devices. Be sure to execute this tool when connecting external devices. For example, the following issues can be solved.

- In the case where the operation log save destination is set to an external device, the Sensor Controller fails to save operation records at start-up.
- In the case where a scene group is saved in an external device, the Sensor Controller fails to load the scene group at start-up.
- When performing a measurement just after the start-up of the Sensor Controller, image logging into an external device fails.



### Important

- Once this tool was utilized, the external device information cannot recover the factory settings even when [System initialization] in [Function] menu is executed.
- Remote operation is not supported.
- When executing this tool, the following information at the time of the tool executed is stored in the Sensor Controller.
  - Information on connected external storage such as device drivers and drive letters.
  - Information on communication settings such as IP addresses.
 

If you changed the connecting configuration of external storage, or communication settings such as IP addresses ([Tool] → [System settings] → [Communication] → [Ethernet] settings), be sure to execute this tool again.
- The information saved by this tool cannot be transferred to another Sensor Controller with "Configuration copy" tool. Execute this tool per the Sensor Controller.
- The information for all connected external devices is memorized. Execute this tool after removing unnecessary external devices to memorize.
- Some of external devices out of operation guarantee need to install a special driver. When using this tool in a state of such external devices connected, the Sensor Controller might incorrectly operate. Do not execute this tool in such condition.
- When a Sensor Controller after this tool was executed is started up with network drives connected, the startup time might become longer.

## Using the tool

- 1 Turn on the Sensor Controller after connecting all external devices.
- 2 In the Main Window, select [Tool] → [Device information storage tool]. The following dialog box is displayed.



### 3 Click [OK].

The following “Executing” dialog box is displayed to indicate the processing progress.

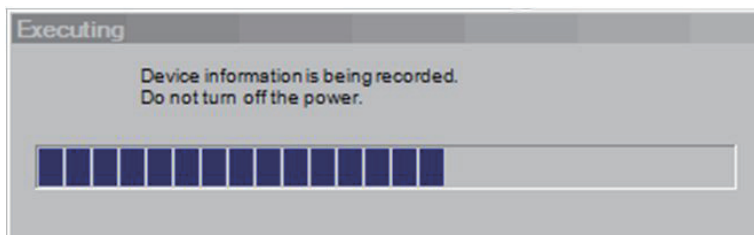

### 4 When the processing is completed, the dialog box is automatically closed.



#### **Important**

---

- Do not reboot or turn off the Sensor Controller while the “Executing” dialog box is displayed. The data and the external device may corrupt.
-



### 3-6-3 Restarting the Controller: [System Restart]

You can restart the Controller. Before restarting, back up any required data, such as scene data and system data.

Refer to 9-2 *Saving Settings Data to the Flash Memory* on page 9-7.

#### Restarting with Sensor Controller

- 1 Select [System restart] from the [Function] menu.  
The [System restart] dialog box is displayed.
- 2 Click [OK].  
The Controller is restarted.
- 3 The settings data saved in the flash memory is enabled.

#### Restarting with Remote Operation

- 1 End the remote operation.  
For the operation method, refer to 10-1-3 *Terminating Remote Operation* on page 10-13.
- 2 From the [Start] menu on your PC, select [All Programs] - [OMRON] - [FZ\_FH Series] - [FH\_FHV Launcher].  
FH/FHV Launcher window appears.
- 3 Click the [Remote Operation Tool] button.

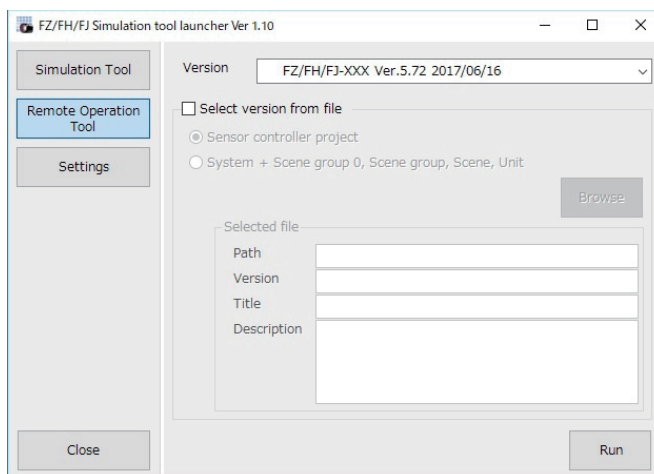

- 4 In the [Version], select the version of the measurement application of the sensor controller to be controlled remotely.
- 5 Click the [Run] button.  
Note that the Sensor Controller must be placed in a measurement capable state.



#### Precautions for Correct Use

Do not connect or disconnect the [Remote Operation Tool] during a measurement or the system running.

**6** Click [Browse].

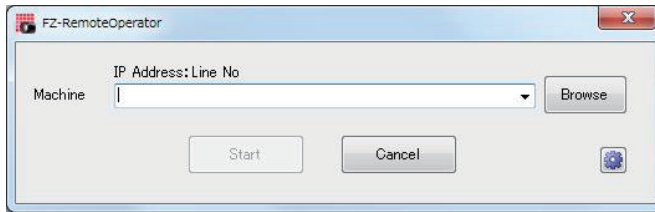

A "Network reference" list will be displayed.

When you run the simulation software of the sensor controller on the remote operation side PC, the simulation software information may be displayed in the Network reference list.

**7** Select your target Sensor Controller from the list, click [Restart].

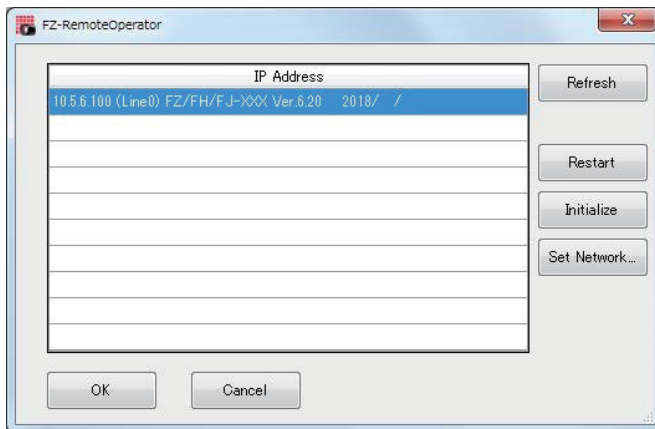

**8** Click [OK].



The Controller is restarted.

## 3-7 Initializing the Controller

You can restore all settings of the Controller to default settings. However, the security settings will not be affected.

Before you initialize the Controller, back up any required data, such as scene data and system data. Refer to Section 9 Saving/Loading Data.

### Initializing with Sensor Controller

- 1** Select [System initialization] from the [Function] menu.  
The [System initialization] dialog box is displayed.
- 2** Click [OK].  
A confirmation dialog box is displayed.
- 3** Click [OK].  
The Controller is initialized and restarted.

### Initializing with Remote Operation

- 1** End the remote operation.  
For the operation method, refer to *10-1-3 Terminating Remote Operation* on page 10-13.
- 2** From the [Start] menu on your PC, select [All Programs] - [OMRON] - [FZ\_FH Series] - [FH\_FHV Launcher].  
FH/FHV Launcher window appears.
- 3** Click the [Remote Operation Tool] button.

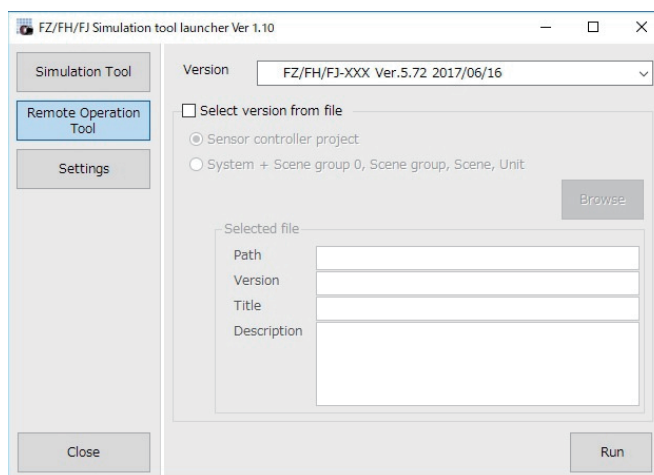

- 4** In the [Version], select the version of the measurement application of the sensor controller to be controlled remotely.

## 5 Click the [Run] button.

Note that the Sensor Controller must be placed in a measurement capable state.



### Precautions for Correct Use

Do not connect or disconnect the [Remote Operation Tool] during a measurement or the system running.

## 6 Click [Browse].

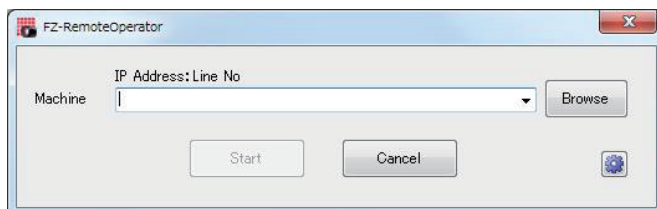

A "Network reference" list will be displayed.

When you run the simulation software of the sensor controller on the remote operation side PC, the simulation software information may be displayed in the Network reference list.

## 7 Select your target Sensor Controller from the list, click [Initialize].

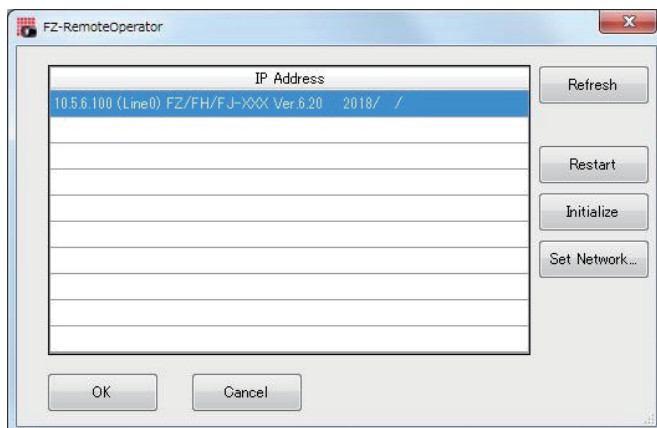

## 8 Click [OK].

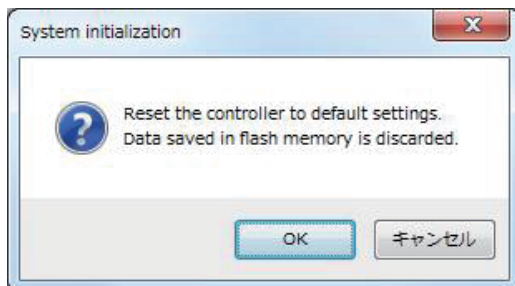

The Controller is initialized and restarted.

## 3-8 Turning OFF the LCD

### 3-8-1 Turning OFF the LCD [LCD OFF]

(This function is supported only by the FZ5-600/800/1100/1200 series LCD-integrated Controllers.)

You can turn OFF the LCD without turning OFF the Controller.

- 1 Click the [LCD off] button that is located on the Measurement Manager Bar in the lower right corner of the window.

A confirmation message is displayed.

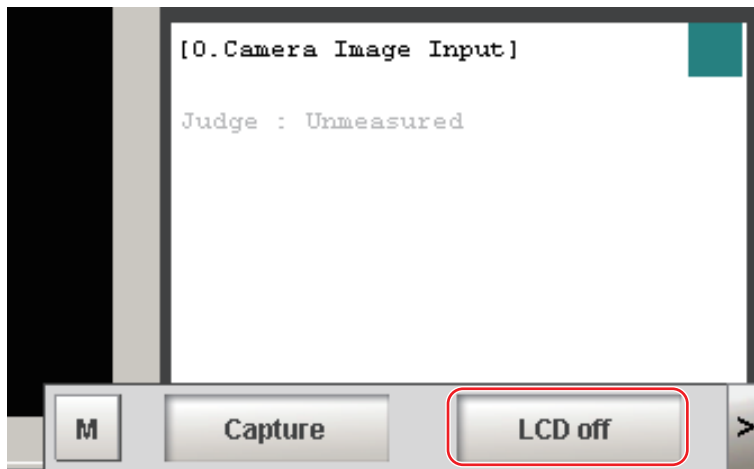

- 2 Click [OK].  
Power to the LCD is turned OFF.

### 3-8-2 Restoring Power to the LCD

(This function is supported only by the FZ5-800/1100/1200 series LCD-integrated Controllers.)

Click the bottom edge of the LCD.

After a while, the LCD power will turn ON.



# 4

## Setting the Controller

This section describes settings related to the system environment for the controller.

4

---

<b>4-1</b>	<b>Selecting Language [Startup Settings]</b>	<b>4-2</b>
<b>4-2</b>	<b>Setting the Status at Startup [Startup Settings]</b>	<b>4-3</b>
<b>4-3</b>	<b>Setting Communication [Startup Settings]</b>	<b>4-6</b>
<b>4-4</b>	<b>Setting Operation Mode [Startup Settings]</b>	<b>4-12</b>
4-4-1	Setting the Operation Mode	4-13
4-4-2	Parallel Processing	4-29
<b>4-5</b>	<b>Checking the Camera Connections: [Camera Connection]</b>	<b>4-39</b>
<b>4-6</b>	<b>Setting the Trigger Delay [Inter-camera Setting]</b>	<b>4-40</b>
<b>4-7</b>	<b>Setting the SHTOUT Signal [Output Signal Settings]</b>	<b>4-43</b>
<b>4-8</b>	<b>Setting the Conditions Related to Communications</b>	<b>4-46</b>
<b>4-9</b>	<b>Setting Date/Time [Date/Time Settings]</b>	<b>4-47</b>
<b>4-10</b>	<b>Setting Fan Control [Fan Control Setting]</b>	<b>4-49</b>
<b>4-11</b>	<b>Setting the Pulse Width for the STEP Input Detection [STEP Signal Filter Setting]</b>	<b>4-50</b>
<b>4-12</b>	<b>Setting Encoder Trigger [Encoder Trigger Setting]</b>	<b>4-51</b>
<b>4-13</b>	<b>Setting Network Drive [Network Drive Setting]</b>	<b>4-53</b>
<b>4-14</b>	<b>Setting Screen Capture [Screen Capture Setting]</b>	<b>4-57</b>
<b>4-15</b>	<b>Setting the Conditions that are Related to Operation during Measurement [Measurement Conditions]</b>	<b>4-58</b>
<b>4-16</b>	<b>Setting Logging Conditions [Logging Setting]</b>	<b>4-60</b>
<b>4-17</b>	<b>Setting Operation Log [Operation Log Setting]</b>	<b>4-61</b>
<b>4-18</b>	<b>Setting the Operation at Error [Error Operation Setting]</b>	<b>4-62</b>
<b>4-19</b>	<b>Setting Character Code using Macro/Variable Function [Macro/Variable Function Setting]</b>	<b>4-64</b>

## 4-1 Selecting Language [Startup Settings]

You can set the language to use for the characters displayed on the displays. Information about the application software will be displayed in the selected language.



### Additional Information

- When a Controller with default settings is started, the [Language setting] dialog box is automatically displayed.
- The Controller default setting is for Japanese-language displays. If the language setting is changed to a non-Japanese language, the system automatically restarts.

**1** In the Main Window, select [System settings] – [Startup] – [Startup setting] – [Language Setting] from the [Tool] menu.

The [Language setting] dialog box is displayed.

**2** Click the [▼] button to select the language.

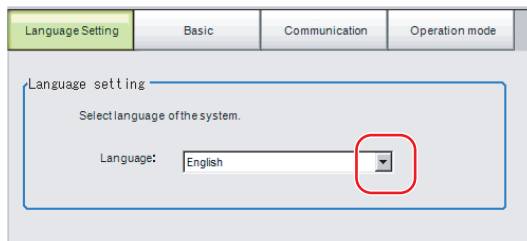

**3** Click the [Apply] button.

**4** Return to the Main Window and click the [Data save] button. Then, restart the Controller. The Controller will start up with the selected language.



### Additional Information

The [Language setting] dialog box is also displayed when restarting after executing [System initialization].



## 4-2 Setting the Status at Startup [Startup Settings]

You can set the status when the power supply is turned ON.

Inspection will start immediately after the power supply is turned ON, if you select the Scene number and Scene group number that sets measurement contents.

- 1 In the main window, select [Tool] [System settings] – [Basic] tab to see the Startup layout settings.

The [Startup setting] dialog box is displayed.

- 2 Change the settings.

Setting Item	Set value [Factory default]	Description
Scene		
Specify startup scene, scene group	[Selected] Not selected	The selected the Scene number and Scene group number will be used at startup. The Scene number and Scene group number last saved with [Data save] function will be used at startup.
Scene group	Scene group 0 to 31 [Scene group 0]	Select the Scene group number at startup.
Scene	Scene 0 to 127 [Scene 0]	Select the Scene number at startup.
Startup layout		Select the Layout number displayed at startup.
Layout (Local)	Layout 0 to 8 [Layout 0]	Select the Layout number displayed at Sensor Controller's startup.
Layout (Remote)	Layout 0 to 8 [Layout 0]	Select the Layout number displayed at Remote PC's startup.
Non-stop adjustment mode (Line1)	Layout 0 to 8 [Layout 0]	Select the Layout number displayed at Non-stop adjustment mode's startup.
Measurement manager bar state	• [Open] • Close	Sets the Measurement Manager Bar status for Sensor Controller startup

Setting Item	Set value [Factory default]	Description
Operation priority		Selects the operation priority to either measurement results display or menu operation.
	[Measurement result priority]	Processing of measurement results display is given priority. Menu operation will be harder to receive because of its lowered priority status.
	Menu operation priority	Menu operation is given priority. Measurement results display may be incomplete.
Measurement initialization priority		Measurement initialization is performed immediately after changing the scene or editing the flow. You can specify whether measurement trigger reception or display refresh processing has priority during measurement initialization.  When the "Manual Position Setting" processing unit is set in the measurement flow, an action when the "Processing of redrawing on screen priority" is set up is performed regardless of the settings.
	[Measurement trigger receipt priority]	Measurement trigger reception is given priority even during measurement initialization processing. Displays for display refresh processing may be incomplete because of its lowered priority status.
	Processing of redrawing on screen priority	Processing of refreshing the display is given priority. Measurement triggers will not be received until display refresh processing is completed.
Measurement priority		Specify whether the processing priority is Measurement, or Communication.
	[Run the measurement process as the top priority]	Measurement processing is the highest priority. This setting is normally recommended.
	Lower the priority of the measurement process.	Communication processing is higher priority. Communication is given higher priority even if measurement processing runs with high-load. Therefore, measurement processing time will be longer.  This setting is beneficial when a missed data is occurred due to no handshake communication on EtherNet/IP.
Relocate memories		Select the relocate processing. <sup>(*1)</sup>
	[Relocate]	Relocate processing is executed.  More units can be registered to one Scene group because this function improves the memory efficiency. <ul style="list-style-type: none"> <li>• At startup.</li> <li>• When the Scene group is selected.</li> <li>• When the Processing Unit is added.</li> <li>• When Scene or Processing Unit is copied.</li> <li>• When scene data, such as registered, or re-registered Model, or Measurement region is changed.</li> </ul> It is normally recommended to use [Relocate].
	Do not relocate	Relocate processing is not carried out.  Set this setting when Relocate processing takes long time.

**Important**

---

\*1 For FH series/FZ5-800/1100/1200 series, [Relocate memories] setting is invalid.

\*2 Relocate processing could be take time depends on relocated data capacity or data fragmentation when [Relocate] is selected.

\*3 An error may occur; e.g. data is insufficient because data relocate processing is not carried out when [Relocate] is selected. For data memory region, refer to *A-9 About Memories Usable with FH series/FZ5 series* on page A-29.

---

# 4-3 Setting Communication [Startup Settings]

Select the type of Communications Module to determine the communications method to use for communications between the Sensor Controller and external device.

Refer to the *Vision System FH/FHV/FZ5 Series User's Manual for Communications Settings* (Cat. No. Z342) for details on how to select the Communications Module.

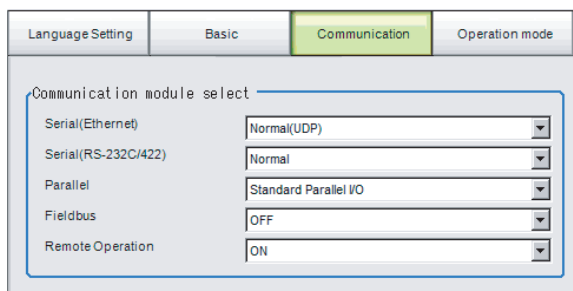

Item	Set value [Factory default]	Description
Serial (Ethernet)	<ul style="list-style-type: none"> <li>[Normal (UDP)]</li> <li>Normal (TCP)</li> <li>Normal (TCP Client)</li> <li>Normal (UDP) (Fxxx series method)</li> <li>PLC Link (SYSMAC CS/CJ/CP/One)</li> <li>PLC Link (MELSEC QnU/Q/QnAS)</li> <li>PLC Link (JEPMC MP)</li> </ul>	<p>Specify the Communications Module.</p> <p>Serial/Ethernet</p> <p>Normal/Normal (Fxxx series method): Communications are performed with external devices through [non-procedure] communications.</p> <p>For differences between [Normal] and [Normal (Fxxx series method)], refer to the following note.</p> <p>PLC Link: Communications are performed through link areas with the PLC.</p>
Serial (RS-232C/RS-422)	<ul style="list-style-type: none"> <li>[Normal]</li> <li>Normal (Fxxx series method)</li> <li>PLC Link (SYSMAC CS/CJ/CP/One)</li> <li>PLC Link (MELSEC QnU/Q/QnAS)</li> <li>Touch Panel Monitor (FH-MT12)</li> </ul>	<p>Touch Panel Monitor (FH-MT12): Comm te via Touch Panel Monitor (FH-MT12)</p> <p>Parallel Standard Parallel I/O: Communications are performed with a standard parallel interface.</p>
Parallel	[Standard Parallel I/O]	Communications are performed with a standard parallel interface.
Fieldbus	<ul style="list-style-type: none"> <li>[OFF]</li> <li>EtherCAT</li> <li>EtherNet/IP</li> </ul>	<p>Fieldbus: Communications are performed through EtherCAT communications and the EtherNet/IP interface. EtherCAT is supported only by the FH series Sensor Controller.</p>
Remote Operation	<ul style="list-style-type: none"> <li>[ON]</li> <li>OFF</li> </ul>	<p>Remote operation: The Controller is operated from an external device.</p>

**Important**

- Do not set [EtherNet/IP] and [PLC Link] at the same time. They cannot be used at the same time.  
Example:  
Set [Serial (Ethernet)] to [PLC Link] and [Fieldbus] to [EtherNet/IP] at the same time.  
Set [Serial (RS-232C/422)] to [PLC Link] and [Fieldbus] to [EtherNet/IP] at the same time.  
Set both [Serial (Ethernet)] and [Serial (RS-232C/422)] to [PLC Link], and set [Fieldbus] to [EtherNet/IP] at the same time.
- Do not set both [Serial (Ethernet)] and [Serial (RS-232C/422)] to [PLC Link]. They cannot be used at the same time.

**Additional Information**

- Normal (Fxxx Series Method)  
With the [Normal (Fxxx series method)] communications method, the OK response timing in relation to MEASURE commands is different from that of the [Normal] communications method.

Normal (Fxxx series method) communications method	Normal communications method
MEASURE	MEASURE
Measurement result	OK
OK	Measurement result

- OK Responses  
With [Normal communications method], an OK response is returned when the Controller receives a command.  
With [Normal (Fxxx series method)], an OK response is returned when command execution is completed.

## Settings for Touch Panel Monitor

An exclusive touch screen monitor, Touch Panel Monitor is available for FH Sensor Controllers to confirm images or to display menus for condition settings.



### Important

- The Touch Panel Monitor (FH-MT12) is used exclusively with the FH series Sensor Controllers. It cannot be used with FZ5 series Sensor Controller.
- The Touch Panel Monitor (FH-MT12) is supported only by Ver. 5.32 or later versions of the FH series Sensor Controller.

To wire the Touch Panel Monitor (FH-MT12) and an FH series Sensor Controller, a monitor cable for video input and a touch panel cable for touch panel communication are required.

Normally, use a USB cable connection for the Touch Panel Monitor (FH-MT12).

#### USB connection

(Maximum cable length: 5 m)

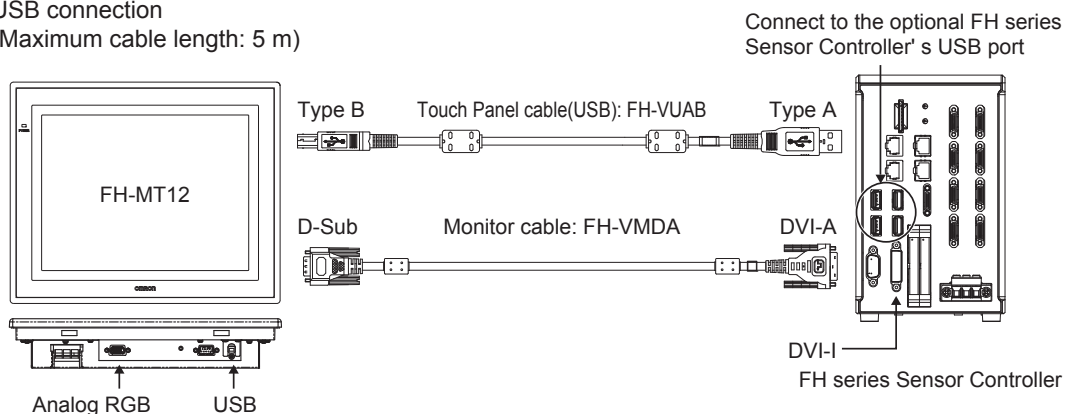

Use an RS-232C cable connection in the following cases.

- The Touch Panel Monitor (FH-MT12) and the FH series Sensor Controller are more than 5 m apart.
- All the USB ports of the FH series Sensor Controller are used for other I/O connections, and thus there is no available USB port for the Touch Panel Monitor (FH-MT12) connection.

#### RS-232C connection

(Maximum cable length: 10m)

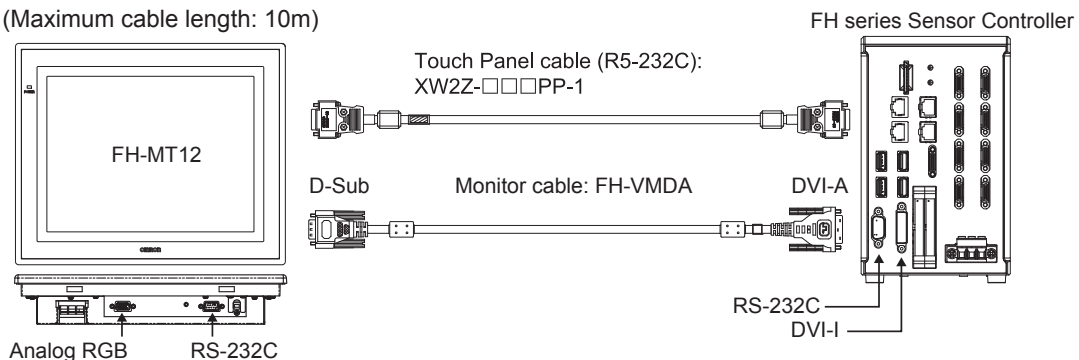

For monitor cable of video input or communication cable of Touch Panel, refer to the followings:

### ● Connection cable for FH-MT12

Cable name	Type	Cable length	Model	Minimum bend radius
Monitor cable	DVI-RGB converter cable	2 m	FH-VMDA 2M	36 mm
		5 m	FH-VMDA 5M	
		10 m	FH-VMDA 10M	
Touch Panel cable	USB	2 m	FH-VUAB 2M	25 mm
		5 m	FH-VUAB 5M	
	RS-232	2 m	XW2Z-200PP-1	59 mm
		5 m	XW2Z-500PP-1	
		10 m	XW2Z-010PP-1	

When connect the monitor cable, Sensor Controller recognizes Touch Panel Monitor automatically, and then start to display.



#### Additional Information

When use only monitor function of Touch Panel Monitor (FH-MT12), confirm the followings:

- You can use both FH series Sensor Controller and FZ5 series Sensor Controller.
- No limitation of software version of FH series/FZ5 series Sensor Controller.
- Not cable for Touch Panel Monitor, but only monitor cable for video.

The setting steps for the touch panel monitor and the communication module are as follows.

- 1 Connect the Touch Panel Monitor to the FH series Sensor Controller.

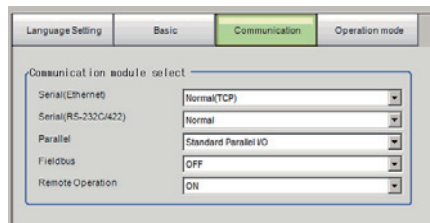

- 2 In the Main Window, click [Tool] - [System Settings] - [Startup] - [Startup setting], then click [Communication]

- 3 On the Communication module select area, select [Touch Panel Monitor (FH-MT12)] from the [Serial (RS-232C/422)].

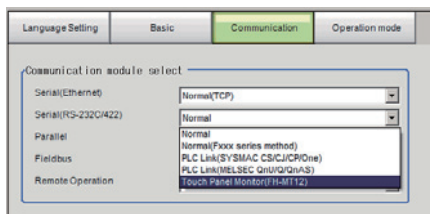

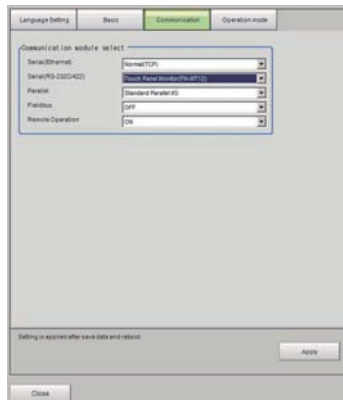
**4** Click [Apply].**5** Click [Close].**6** Click [Data save] in the tool bar on the Main Window and then click [OK] on the "Data save" dialog box displayed.**7** Click [System restart] in the [Function] menu on the Main Window.**8** Click [OK] on the [System restart] dialog.  
Restarts the FH series Sensor Controller.**9** Touch Panel Monitor can be used after restarting.**Important**

- When using the Serial (RS-232C/422) cable for RS-232C communication, connect the Touch Panel Monitor (FH-MT12) to the FH series Sensor Controller before startup.
- The limitations when you set the serial (RS-232C/422) for RS-232C communication are the followings:
  - If the RS-232C cable, or Touch Panel Monitor is disconnected when the FH series Sensor Controller is started, the startup time will be approximately 30 seconds longer. If the Touch Panel Monitor cable is disconnected while the FH series Sensor Controller is in operation, it will not be usable, even if reattached, until the system is restarted. Confirm the connection of Touch Panel Monitor (FH-MT12) and FH series Sensor Controller, then restart FH series Sensor Controller.



## Difference in Touch Panel Monitor Communications

There are two types of connections for touch panel communication: USB connection and RS-232C connection.

Normally use a USB connection for the touch panel.

Use an RS-232C connection in the following cases.

- The Touch Panel Monitor (FH-MT12) and the FH series Sensor Controller are more than 5 m apart.
- All the USB ports of the FH series Sensor Controller are used for other I/O connections, and thus there is no available USB port for the Touch Panel Monitor (FH-MT12) connection.

Note that following restrictions apply to each type of communication.

Subject	USB connection	RS-232C connection
Cable length	2 m or 5 m	2 m, 5 m, or 10 m
Communication module setting on FH series Sensor Controller	No setting required	Serial (RS-232C/422) setting required
Startup order for Touch Panel Monitor and FH series Sensor Controller	No restriction	1. Connect cables 2. Start the Touch Panel Monitor 3. Start the FH series Sensor Controller
Startup time of FH series Sensor Controller without touch panel cable connected	Standard	30 seconds longer
Resulting behavior when simultaneously using both USB connection and RS-232C connection.	The USB connection overrides the RS-232C connection.	



### Important

- If the Touch Panel cable (USB or RS-232C) is accidentally slipped out during FH series Sensor Controller is running, cannot operate the Touch Panel even if you try to re-connection the cable. For continue to operation or perform, connect a wired USB mouse which is not need to install driver.
- To re-operate the Touch Panel, confirm the connection Touch Panel Monitor FH-MT12 and FH series Sensor Controller, and then retry to initiate the Sensor Controller.



### Additional Information

For detail of OSD (On-screen display), refer to *Model FH-MT12 Touch Panel Monitor INSTRUCTION SHEET*.

## 4-4 Setting Operation Mode [Startup Settings]

Select the operation mode according to the application conditions, such as the operation mode that is best suited to reduce the takt time and downtime.

Refer to *4-4-1 Setting the Operation Mode* on page 4-13 for details on the operation modes.

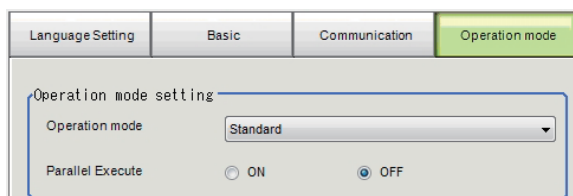

Item	Set value [Factory default]	Description
Operation mode	<ul style="list-style-type: none"> <li>• Double Speed Multi-input</li> <li>• [Standard]</li> <li>• Multi line random trigger</li> <li>• Non-stop adjustment</li> </ul>	Set the operation mode. Refer to <i>4-4-1 Setting the Operation Mode</i> on page 4-13.
Parallel execution	ON/[OFF]	Set whether to uses parallel processing. Refer to <i>Parallel Processing Settings (Automatic Parallelization)</i> on page 4-29.

- 1 Click the [Apply] button.

## 4-4-1 Setting the Operation Mode

This section describes the operation mode (FH series and FZ5-800/1100/1200 series only). You can use a multi-core CPU to set the operation mode according to the application conditions. This helps to reduce the takt time and downtime. The operation mode is set in the startup settings.

Refer to 4-2 *Setting the Status at Startup [Startup Settings]* on page 4-3 and 1-1-2 *Functional Comparison between the FH-series, FHV-series and FZ5-series Controllers* on page 1-3.

- 1 In the Main Window, select [System settings] – [Startup settings] from the [Tool] menu. The Startup settings dialog box is displayed.
- 2 Click the [Operation mode] button and select the operation mode.

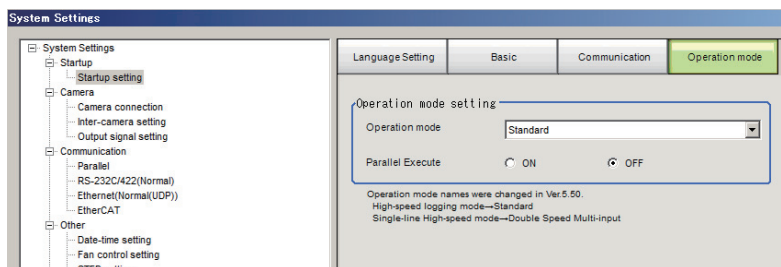

- 3 Click the [Apply] Button.
- 4 In the Adjustment Window (layout 0), click [Data save] in the Toolbox Pane to save the settings data.
- 5 In the Main Window, select [System restart] from the [Function] menu. The System restart dialog box is displayed.
- 6 Click [OK].

## Selection Guide for Operation mode

A guide to using the most suitable operation mode for your purpose.

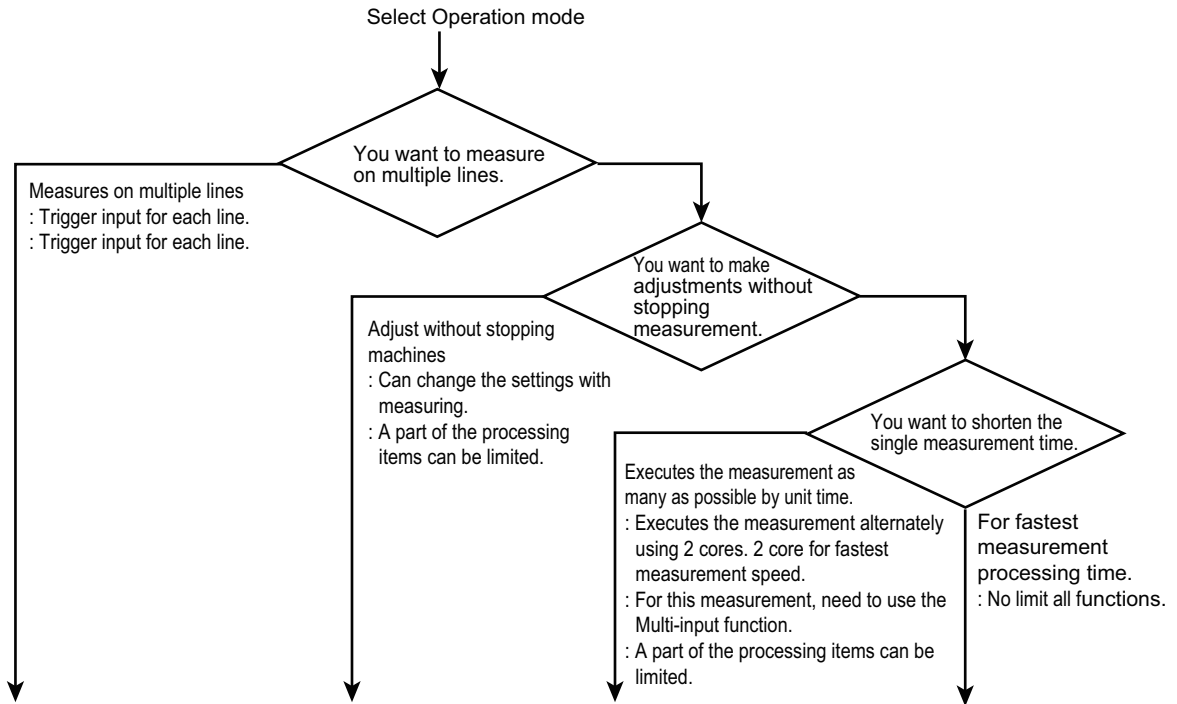

Multi-line Random-trigger mode	Non-stop Adjustment mode	Double Speed Multi-input mode <sup>*1</sup>	Standard mode <sup>*2</sup>
<ul style="list-style-type: none"> <li>This mode can input the trigger to each lines.</li> <li>Input or Output of communication can be limited depending on used the number of lines.</li> <li>Processing time may be longer than Standard mode if you increase the number of lines.</li> </ul>	<ul style="list-style-type: none"> <li>This mode allows changes to be made to settings while running measurement processing.</li> <li>Some processing items may not be applied to use or may be restricted.</li> <li>Using commands from the external device are restricted.</li> <li>Unintended operation may be occurred if you change the Scene while this function is running.</li> </ul>	<ul style="list-style-type: none"> <li>For this Operation mode, need to use the Multi-input function.</li> <li>This mode allows the highest number of measurements within a single unit of measurement time.</li> <li>In this function, some processing unit items are not applied or limited.</li> <li>Using the command from external device is limited.</li> </ul>	<ul style="list-style-type: none"> <li>This mode allows for the fastest measurement time for a single measurement.</li> <li>All functions can be used without restriction.</li> </ul>

\*1. This mode name is changed from Ver. 5.50. This function name is Single-line High speed mode in old model.

\*2. This mode name is changed from Ver. 5.50. This function name is High-speed Logging mode in old model.

Refer to *Multi-input Function* on page 4-16.

Refer to *1-1-2 Functional Comparison between the FH-series, FHV-series and FZ5-series Controllers* on page 1-3.

## Double Speed Multi-input

You can execute the measurement process with a multi-core CPU to inspect more measurement targets in less time than conventional processing would allow. This mode uses up to four CPU cores (or eight threads) on a CPU that take turns in the execution of a single inspection flow every time the STEP signal is input.

Refer to *Multi-input Function* on page 4-16.

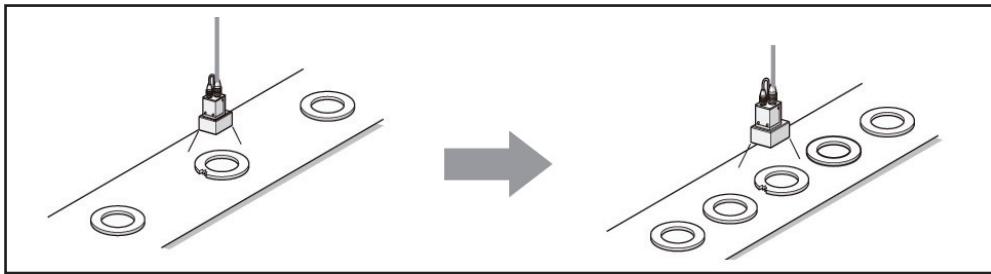

### Important

- The transaction time for a single workpiece is shorter if parallel processing is enabled to allow parallel execution of the measurement flow. Refer to *4-4-2 Parallel Processing* on page 4-29.
- It is assumed that the [Double Speed multi-input] will be used together with the multi-input function. Refer to *Multi-input Function* before you use the Double Speed Multi-input. When the multi-input function cannot be used, the Double Speed Multi-input mode is not available. Choose another mode than the Double Speed Multi-input mode. Refer to *Multi-input Function* on page 4-16.
- Certain processing items, such as Serial Output, Parallel Output, and Parallel Judgement Output, may slow the performance of the Double Speed Multi-input mode if they are programmed in the first half of the flow. If the performance drops significantly, consider the use of parallel processing.
- Some processing items, such as Trend Monitor and Last NG Display, may not function correctly if Double Speed Multi-input is used. Do not use them. Calculation items that use the numeric values from a previous STEP may not calculate correctly.
- You cannot use Simplified Non-stop Adjustment Mode during Double Speed Multi-input.
- External commands to obtain and set unit data will not operate correctly. Do not use them.
- If you use external commands, the BUSY signal will remain ON during command execution longer than for other operation modes.
- Compared with other operation modes, it will take more time to perform processing which includes screen transition, such as Scene switch, Scene group switch and Edit flow.

### ● About Double Speed Multi-input

Two cores performs the same inspection flow alternatively, which help to shorten measurement takt time.

Example: Normal processing with a single core CPU

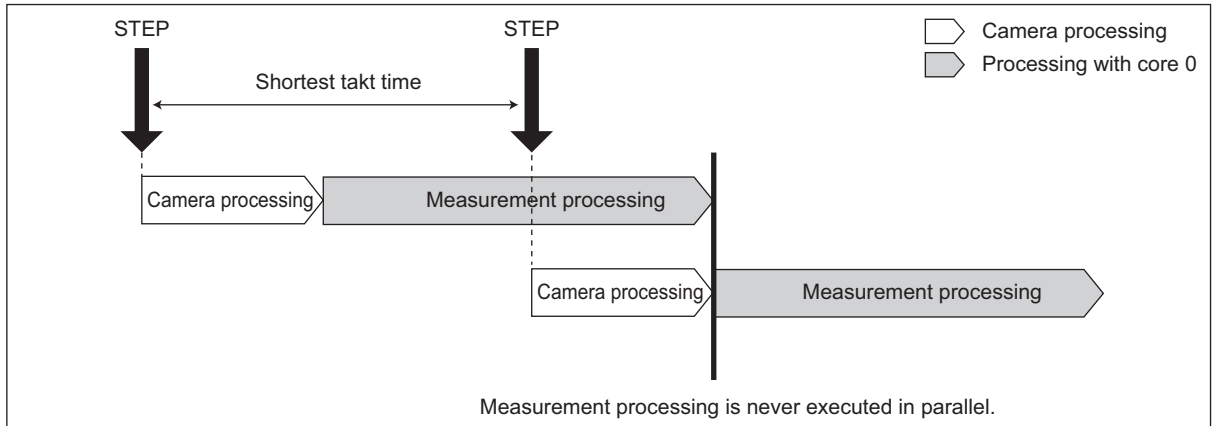

Example: Processing using the Double Speed Multi-input with dual-core CPU

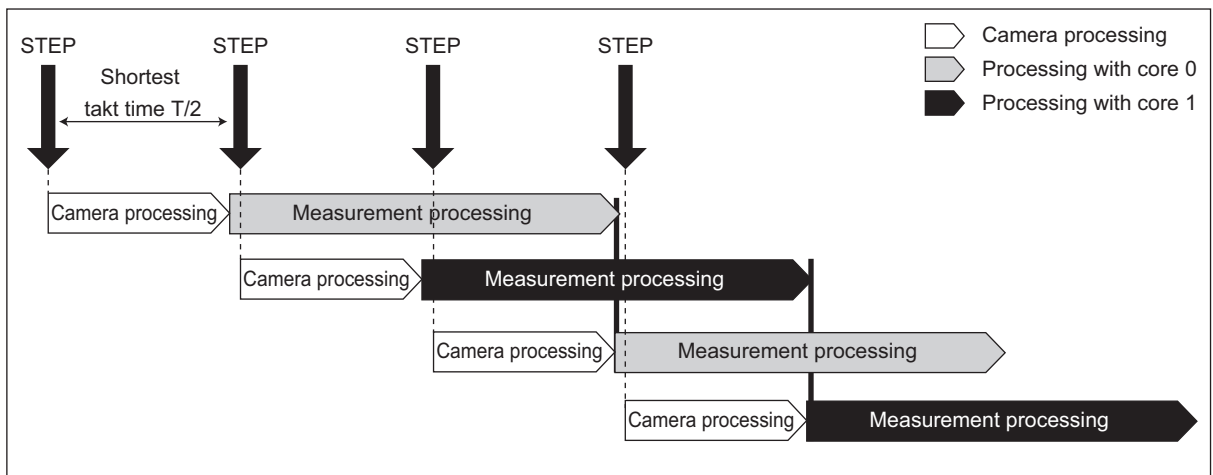

### ● Multi-input Function

With the multi-input function, images are input consecutively and at high speed. This allows the next STEP to be received as soon as the image input processing is completed. There is no need to wait for measurement processing to be completed. You can check whether image input processing has been completed with the status of the READY signal.

There are no setting items for the multi-input function. You can use it as long as you can check the status of the READY signal, i.e., as long as you use parallel or EtherCAT communications. With EtherCAT communications, check the status of the Trigger Ready signal instead of the READY signal.

The FH series and FZ5-800/1100/1200 series Sensor Controller both have a multi-core CPU. Using the Double Speed Multi-input, where each CPU core takes turns in the execution of the measurement processing, realizes the reduction of the minimum takt time\*1 by up to 1/2 for the FZ5 series Sensor Controller and 1/4 for the FH-3050.

\*1. The fastest takt time is the shortest time that is allowed to accept a STEP signal without causing a backlog of images.

Refer to *Double Speed Multi-input* on page 4-15.



### Important

- Click the upper left of the Image Display Pane and set the [Image mode] to [Freeze Image]. Refer to 3-2-7 *Changing the Image Mode and Other Display Contents* on page 3-24.
- If images are taken consecutively at high speed, the number of images that you will be able to take will be limited. If the maximum number of images have been taken, the READY signal will not turn ON until the current processing is completed. Therefore, the next STEP signal cannot be input.
- The ERROR terminal turns ON if a STEP signal is input when the READY signal is OFF.
- If the trigger signal input rate is faster than the communications output, some STEP signals may be skipped and measurements may be delayed. Make sure to input trigger signals at a rate that does not cause a delay in communications.
- The multi-input function cannot be used in the following cases:
  - The flow has more than one camera input processing unit.
  - The flow has a Camera Image Input HDR or Camera Image Input HDR Lite processing unit.
  - Branching is used to process a single camera input processing unit more than one time.
- Measurement triggers are input through means other than parallel or EtherCAT communications (non-procedure commands or measurement commands through a PLC Link).
- If a measurement trigger is input while using the multi-input function, the last NG image cannot be displayed.
- If images and data are logged to a network drive, the use of the multi-input function and other heavy measurement loads on the Controller may slow down communications and cause logging errors. In this case, set the measurement takt time so that there is some leeway.
- When the multi-input function is in use, most of the resources of the CPU are allocated to measurement processing. This may cause performance drops (delayed responses and packet losses) and communications errors. Do not use Ethernet/IP communications while the multi-input function is in use.

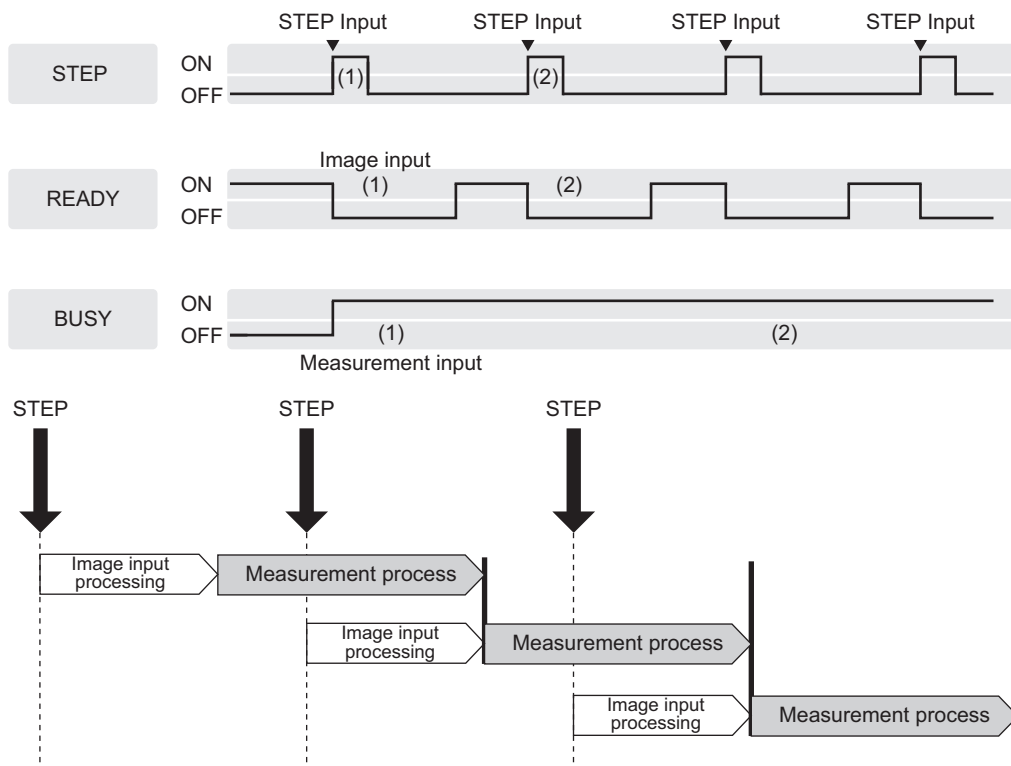

The following processing items are supported in Double Speed Multi-input:

OK:Supported processing item, RST: Processing item with restricted support, ---:Unsupported processing item

Processing item	Support	Processing item	Support	Processing item	Support
Camera Image Input	OK	Back Ground Suppression	OK	Transfer Position Data	OK
Camera Image Input FH	OK	Brightness Correct Filter	OK	Calc Axis Move	OK
Camera Image Input FHV	OK	Color Gray Filter	OK	Calc Axis Move by Multi-point	OK
Camera Image Input HDR	---	Extract Color Filter	OK	Detection Point	OK
Camera Image Input HDR Lite	---	Anti-Color Shading	OK	Camera Calibration	OK
Camera Switching	OK	Stripes Removal Filter II	OK	Data Save	OK
Measurement Image Switching	OK	Polar Transformation	OK	Conditional Branch	OK
Search	OK	Trapezoidal Correction	OK	End	OK
Flexible Search	OK	Machine Simulator	OK	DI Branch	OK
Sensitive Search	OK	Image Subtraction	RST <sup>(1)</sup>	Control Flow Normal	---
ECM Search	OK	Advanced Filter	OK	Control Flow PLC Link	---
EC Circle Search	OK	Panorama	OK	Control Flow Parallel	---
Ec Corner	OK	Calculation	OK	Control Flow Fieldbus	---
Ec Cross	OK	Line Regression	OK	Selective Branch	OK
Shape Search II	OK	Circle Regression	OK	Data Output	OK
Classification	OK	Precise Calibration	OK	Parallel Data Output	OK
Edge Position	OK	User Data	OK	Parallel Judgement Output	OK
Edge Pitch	OK	Set Unit Data	OK	Fieldbus Data Output	OK
Scan Edge Position	OK	Get Unit Data	OK	Result Display	OK
Scan Edge Width	OK	Set Unit Figure	OK	Display Image File	OK
Circular Scan Edge Position	OK	Get Unit Figure	OK	Display Last NG Image	---
Circular Scan Edge Width	OK	Trend Monitor	---	OCR	OK
Color Data	OK	Image Logging	RST <sup>(2)</sup>	OCR User Dictionary	OK
Gravity and Area	OK	Image Conversion Logging	RST <sup>(2)</sup>	Conveyor Calibration	---
Labeling	OK	Data Logging	OK	Conveyor Panorama Display	---
Label Data	OK	Elapsed Time	OK	Photometric Stereo Image Input	OK
Defect	OK	Wait	OK	Display image hold	---
Precise Defect	OK	Focus	OK	Conditional execution (If)	OK
Fine Matching	OK	Iris	OK	Conditional execution (Else)	OK
Character Inspection	OK	Unit Macro	OK	loop	OK
Date Verification	OK	Unit Calculation Macro	OK	Loop suspension	OK
Model Dictionary	OK	Parallelize	OK	scene	OK
2D Codes	OK	Parallelize Task	OK	Select execution (Select)	OK
Circle Angle	OK	Statistics	---	Select execution (Case)	OK
Shape Search III	OK	Calibration Data Reference	OK	System information	OK
Intersection	OK	Position Data Calculation	OK	Manual Position Setting	---
Barcode	OK	Stage Data	OK	2DCode II	OK
Glue Bead Inspection	OK	Robot Data	OK	Result output (I / O)	OK
Position Compensation	OK	Vision Master Calibration	---	Result output (Message)	OK
Filtering	OK	PLC Master Calibration	---		

\*1. The [Subtract only] measurement mode is not supported.

\*2. Images from odd numbered measurements and from even numbered measurements are logged in separate folders.



## Multi-line Random-trigger Mode

You use the Multi-line Random-trigger Mode when you want to measure more than one line with a single Controller. You can measure the inputs from different Cameras on up to eight independent lines. You can set a scene group data and scene data for each line.

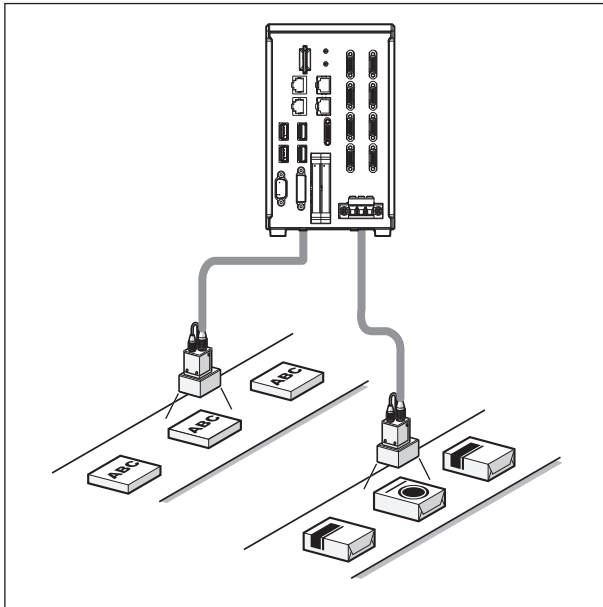

You can switch between lines with the [Line] button that is located on the Measurement Manager Bar that is displayed at the bottom right of the window.

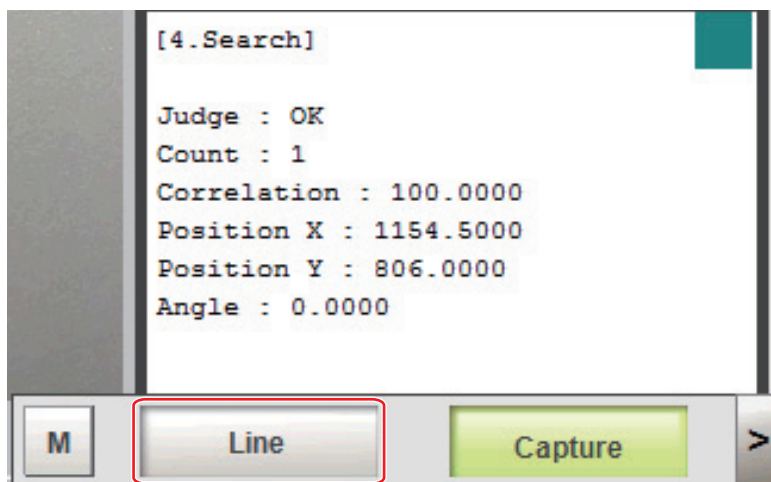

The main screen to be displayed in the foreground can be switched by [Line] on the Measurement manager bar. If the number of lines is 4 lines or less, you can arrange and display the main screen with [Alignment] on the Measurement manager bar.

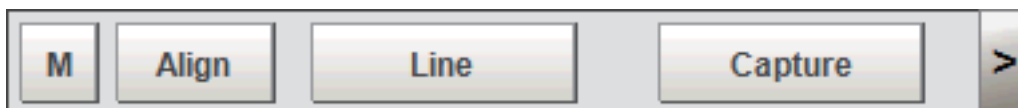

Each line has its own background color.

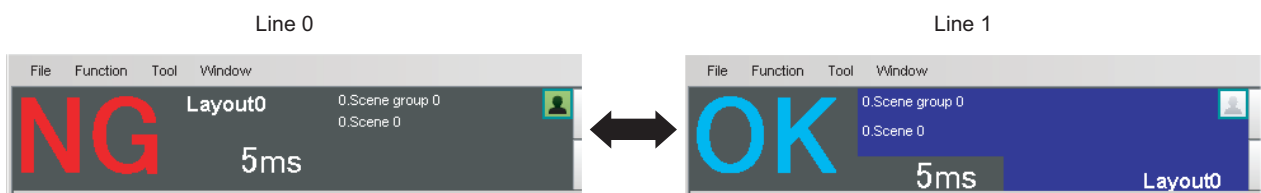

### ● FH-1000/3000/5000 series Sensor Controller

You can assign any of up to eight Cameras to each line.

Use the following procedure to assign Cameras to each line.

- 1** In the Main Window, select [System settings] – [Startup] – [Startup settings] from the [Tool] menu.
- 2** Select [Multi-line random-trigger mode] for the operation mode on the [Operation Mode] tab page.
- 3** Set the [Number of lines] and [Camera - line allotment] on the [Multi-line random-trigger mode settings] tab page.

Multi-line random-trigger mode Settings

Number of lines :

Camera - line allotment :

Camera	0	1	2	3	4	5	6	7
Line0	<input checked="" type="radio"/>	<input checked="" type="radio"/>	<input type="radio"/>	<input type="radio"/>	<input type="radio"/>	<input type="radio"/>	<input type="radio"/>	<input type="radio"/>
Line1	<input type="radio"/>	<input type="radio"/>	<input checked="" type="radio"/>	<input checked="" type="radio"/>	<input checked="" type="radio"/>	<input checked="" type="radio"/>	<input checked="" type="radio"/>	<input checked="" type="radio"/>
Line2	<input type="radio"/>	<input type="radio"/>	<input type="radio"/>	<input type="radio"/>	<input type="radio"/>	<input type="radio"/>	<input type="radio"/>	<input type="radio"/>
Line3	<input type="radio"/>	<input type="radio"/>	<input type="radio"/>	<input type="radio"/>	<input type="radio"/>	<input type="radio"/>	<input type="radio"/>	<input type="radio"/>
Line4	<input type="radio"/>	<input type="radio"/>	<input type="radio"/>	<input type="radio"/>	<input type="radio"/>	<input type="radio"/>	<input type="radio"/>	<input type="radio"/>
Line5	<input type="radio"/>	<input type="radio"/>	<input type="radio"/>	<input type="radio"/>	<input type="radio"/>	<input type="radio"/>	<input type="radio"/>	<input type="radio"/>
Line6	<input type="radio"/>	<input type="radio"/>	<input type="radio"/>	<input type="radio"/>	<input type="radio"/>	<input type="radio"/>	<input type="radio"/>	<input type="radio"/>
Line7	<input type="radio"/>	<input type="radio"/>	<input type="radio"/>	<input type="radio"/>	<input type="radio"/>	<input type="radio"/>	<input type="radio"/>	<input type="radio"/>

For example, if you use Cameras 0 and 1 on line 0, you can use up to 6 Cameras from Camera 2 to 7 on line 1.



#### Important

The settings of the [Multi-line Random-trigger Mode Settings] apply only to the FH series Sensor Controller. In FZ5-800/1100/1200 series Sensor Controller, there will always be two lines and fixed lines assignments to the Cameras regardless of the settings of the [Multi-line Random-trigger Mode Settings].

### ● FZ5 Series

The Camera assignments for each line are listed below.

Camera number	Software handling
Camera 0	Camera 0 on line 0
Camera 1	Camera 0 on line 1
Camera 2	Camera 1 on line 0
Camera 3	Camera 1 on line 1

### ● Functional Limitations of Multi-line Random-trigger Mode

Keep the following points in mind when using Multi-line Random-trigger Mode.

Item		FH series: FH-1000/3000/5000 series	FZ5 series: FZ5-800/1100/1200 series
Processing time		<ul style="list-style-type: none"> <li>If the processing load for multiple lines is high, there may be fluctuation in measurement times.</li> <li>If data logging for multiple lines is to the same drive, measurement times may become longer.</li> </ul>	<ul style="list-style-type: none"> <li>If the STEP signal is input at the exact same time for lines 0 and 1, the measurement on the other lines may be delayed (roughly by the same amount of the Camera Image Input processing unit).</li> <li>If data logging for both Line 0 and Line 1 is to the same drive, measurement times may become longer.</li> </ul>
Number of Cameras		The maximum number of Cameras is 8 for all lines.	The maximum number of Cameras is 2 for all lines.
Error messages		Error messages are the same for lines 0 to 7. If an error occurs on any of the lines, an error message is displayed and the ERROR signal is turned ON.	Error messages are the same for lines 0 and 1. If an error occurs on any of the lines, an error message is displayed and the ERROR signal is turned ON.
Saving data in the Controller		To save data in the Controller, the data must be saved separately for each line.	
Save folder for captured images		When you click [Capture] on the Measurement Manager Bar, captured images are always saved to the folder that is specified for line 0.	
Date-time setting, language setting, operation mode setting and Network drive setting.		These settings can be set only for line 0.	These settings can be set only for line 0.
View		Images can be displayed simultaneously for all lines. Use layout modification to set the display position and size for the Main Window for each line.	One of the lines must be selected to be displayed. Both lines cannot be displayed at the same time.
Communications	Parallel	<ul style="list-style-type: none"> <li>Parallel communications can be set only for line 0. The settings for line 0 are applied to lines 1 to 7.</li> <li>Refer to <i>Table 1</i> for details on the differences between parallel I/O and parallel terminals.</li> </ul>	<ul style="list-style-type: none"> <li>Parallel communications can be set only for line 0. The settings for line 0 are applied to line 1.</li> <li>Refer to <i>Table 1</i> for details on the differences between parallel I/O and parallel terminals.</li> </ul>
	Normal (RS-232C/422)	RS-232C can be set only for line 0. Lines 1 to 7 cannot be used.	RS-232C/422 can be set only for line 0. Line 1 cannot be used.
	Normal (Ethernet)	<ul style="list-style-type: none"> <li>To use Ethernet, use a different port number for each line.</li> <li>The IP address for the Controller cannot be set for lines 1 to 7 (the IP address for line 0 is used).</li> </ul>	<ul style="list-style-type: none"> <li>To use Ethernet, use a different port number for each line.</li> <li>The IP address for the Controller cannot be set for line 1 (the IP address for line 0 is used).</li> </ul>
	PLC Link (RS-232C/422)	RS-232C can be set only for line 0. Lines 1 to 7 cannot be used.	RS-232C/422 can be set only for line 0. Line 1 cannot be used.
	PLC Link (Ethernet)	<ul style="list-style-type: none"> <li>To use Ethernet, use a different port number for each line.</li> <li>The IP address for the Controller cannot be set for lines 1 to 7 (the IP address for line 0 is used).</li> </ul>	<ul style="list-style-type: none"> <li>To use Ethernet, use a different port number for each line.</li> <li>The IP address for the Controller cannot be set for line 1 (the IP address for line 0 is used).</li> </ul>

Item		FH series: FH-1000/3000/5000 series	FZ5 series: FZ5-800/1100/1200 series
Communi- cations	EtherNet/IP	<ul style="list-style-type: none"> <li>To use EtherNet/IP, use an EDS file that matches the line to be used.</li> <li>Specify different I/O memory addresses for the sending area and receiving area for line 0 and for lines 1 to 7.</li> </ul>	<ul style="list-style-type: none"> <li>To use EtherNet/IP, use an EDS file that matches the line to be used.</li> <li>Specify different I/O memory addresses for the sending area and receiving area for line 0 and for line 1.</li> </ul>
STEP setting		The value of the STEP signal filter for the most recently set line is applied to all lines.	The value of the STEP signal filter for each line is applied to each line.
Communi- cations	EtherCAT	<ul style="list-style-type: none"> <li>The Communications Module is set for each line.</li> <li>The communications settings can be set only for line 0. The settings are applied as shown below. [Output control]: The same setting is used for all lines. [Output period]: The same setting is used for all lines. [Output setting]: This is set for each line.</li> <li>The I/O ports (areas) for communications between the FH series Sensor Controller and master are assigned as shown below. I/O ports for the Command Area: I/O ports are assigned for each line. I/O ports for the Response Area: I/O ports are assigned for each line. I/O ports for the Output Area: I/O ports are assigned for each line. The I/O ports in the Sysmac Error Status Area are shared by all lines.</li> <li>The maximum data size that can be output depends on the number of lines, as shown in the following table. 1 to 5 lines: 256 bytes max. 6 to 8 lines: 128 bytes max.</li> </ul>	---

### ● Table 1: Parallel I/O Functions and Parallel Terminals for Multi-line Random-trigger Mode

- FH-1000/3000/5000 series

I/O	Number of lines			
	1 line	2 lines	3 to 4 lines	5 to 8 lines
STEP	STEP0	STEP0 or STEP1	STEP0 to STEP3	STEP0 to STEP7
DSA	DSA0	DSA0 or DSA1	No output	
DI	DI0 to DI7	DILINE0, DI0 to DI7 (shared by all lines)	DILINE0 to DILINE1, DI0 to DI7 (shared by all lines)	DILINE0 to DILINE2, DI0 to DI7 (shared by all lines)
ENC (phases A, B, and Z)	ENC0 phase A, ENC0 phase B, and ENC0 phase Z	ENC0 phase A, ENC1 phase A, ENC0 phase B, ENC1 phase B, ENC0 phase Z, and ENC1 phase Z	No output	
ACK	ACK (shared by all lines)			
RUN	RUN0	RUN0 or RUN1	RUN0 to RUN3	No output
GATE	GATE0	GATE0 and GATE1	No output	
BUSY	BUSY0	BUSY0 or BUSY1	BUSY0 to BUSY3	BUSY0 to BUSY7
OR	OR0	OR0 or OR1	OR0 to OR3	OR0 to OR7
ERROR	ERROR0	ERROR0 or ERROR1	ERROR0 to ERROR3	ERROR (shared by all lines)
READY	READY0	READY0 or READY1	READY0 to READY3	READY0 to READY7
DO	DO0 to DO15	Line 0: D00 to D07 Line 1: D8 to D15	No output	

- FZ5-800/1100/1200 series

I/O	Number of lines	
	1 line	2 lines
STEP	STEP0	STEP0 or STEP1
DSA	DSA0	DSA0 or DSA1
DI	DI0 to DI7	DI0 to DI7
RUN	RUN	None (This input is assigned as the BUSY signal for line 1.)
GATE	GATE0	GATE0 and GATE1
BUSY	BUSY	BUSY or RUN
OR	OR0	OR0 or OR1
ERROR	ERROR	ERROR (shared by all lines)
READY	READY0	READY0 or READY1
DO	DO0 to DO15	Line 0: D00 to D07 Line 1: D8 to D15

The following processing items are supported in the multi-line random trigger mode:

OK:Supported processing item, RST: Processing item with restricted support, ---:Unsupported processing item

Processing item	Support	Processing item	Support	Processing item	Support
Camera Image Input	OK	Stripes Removal Filter II	OK	Data Save	OK
Camera Image Input FH	OK	Glue Bead Inspection	OK	Statistics	OK
Camera Image Input FHV	---	Position Compensation	OK	Calibration Data Reference	OK
Camera Image Input HDR	OK	Filtering	OK	Position Data Calculation	OK
Camera Image Input HDR Lite	OK	Back Ground Suppression	OK	Stage Data	OK

OK:Supported processing item, RST: Processing item with restricted support, ---:Unsupported processing item

Processing item	Support	Processing item	Support	Processing item	Support
Camera Switching	OK	Brightness Correct Filter	OK	Robot Data	OK
Measurement Image Switching	OK	Polar Transformation	OK	Conditional Branch	OK
Search	OK	Trapezoidal Correction	OK	End	OK
Flexible Search	OK	Machine Simulator	OK	DI Branch	RST(*2)
Sensitive Search	OK	Image Subtraction	RST(*1)	Control Flow Normal	OK
ECM Search	OK	Advanced Filter	OK	Control Flow PLC Link	OK
EC Circle Search	OK	Panorama	OK	Control Flow Parallel	RST(*2)
Ec Corner	OK	Calculation	OK	Control Flow Fieldbus	OK
Ec Cross	OK	Line Regression	OK	Selective Branch	OK
Shape Search II	OK	Circle Regression	OK	Data Output	OK
Classification	OK	Precise Calibration	OK	Parallel Data Output	RST(*2)
Edge Position	OK	User Data	OK	Parallel Judgement Output	RST(*2)
Edge Pitch	OK	Set Unit Data	OK	Fieldbus Data Output	OK
Scan Edge Position	OK	Get Unit Data	OK	Result Display	OK
Scan Edge Width	OK	Set Unit Figure	OK	Display Image File	OK
Circular Scan Edge Position	OK	Get Unit Figure	OK	Display Last NG Image	OK
Circular Scan Edge Width	OK	Trend Monitor	OK	OCR	OK
Color Data	OK	Image Logging	OK	OCR User Dictionary	OK
Gravity and Area	OK	Image Conversion Logging	OK	Conveyor Calibration	OK
Labeling	OK	Data Logging	OK	Conveyor Panorama Display	OK
Label Data	OK	Elapsed Time	OK	Photometric Stereo Image Input	OK
Defect	OK	Wait	OK	Display image hold	OK
Precise Defect	OK	Focus	OK	Conditional execution (If)	OK
Fine Matching	OK	Iris	OK	Conditional execution (Else)	OK
Character Inspection	OK	Unit Macro	OK	loop	OK
Date Verification	OK	Unit Calculation Macro	OK	Loop suspension	OK
Model Dictionary	OK	Parallelize	OK	scene	OK
2D Codes	OK	Parallelize Task	OK	Select execution (Select)	OK
Circle Angle	OK	Vision Master Calibration	OK	Select execution (Case)	OK
Shape Search III	OK	PLC Master Calibration	OK	System information	OK
Intersection	OK	Transfer Position Data	OK	Manual Position Setting	OK
Barcode	OK	Calc Axis Move	OK	2DCode II	OK
Color Gray Filter	OK	Calc Axis Move by Multi-point	OK	Result output (I / O)	OK
Extract Color Filter	OK	Detection Point	OK	Result output (Message)	OK
Anti-Color Shading	OK	Camera Calibration	OK		

\*1. [DI Register] in the measurement mode is not supported.

\*2. Not supported for 3 or more lines.

## Non-stop Adjustment Mode

Non-stop Adjustment Mode allows you to change and adjust the measurement flow without having to stop the measurement processing during operation.

You use saved image files to adjust measurement flows. You can apply a modified measurement flow while the Controller is in RUN mode.

Lines 0 and 1 are used simultaneously for the execution of the Non-stop Adjustment Mode.

While the measurement process is executed for line 0, you modify and adjust the measurement flow for line 1.

### ● Typical Application for Non-stop Adjustment Mode

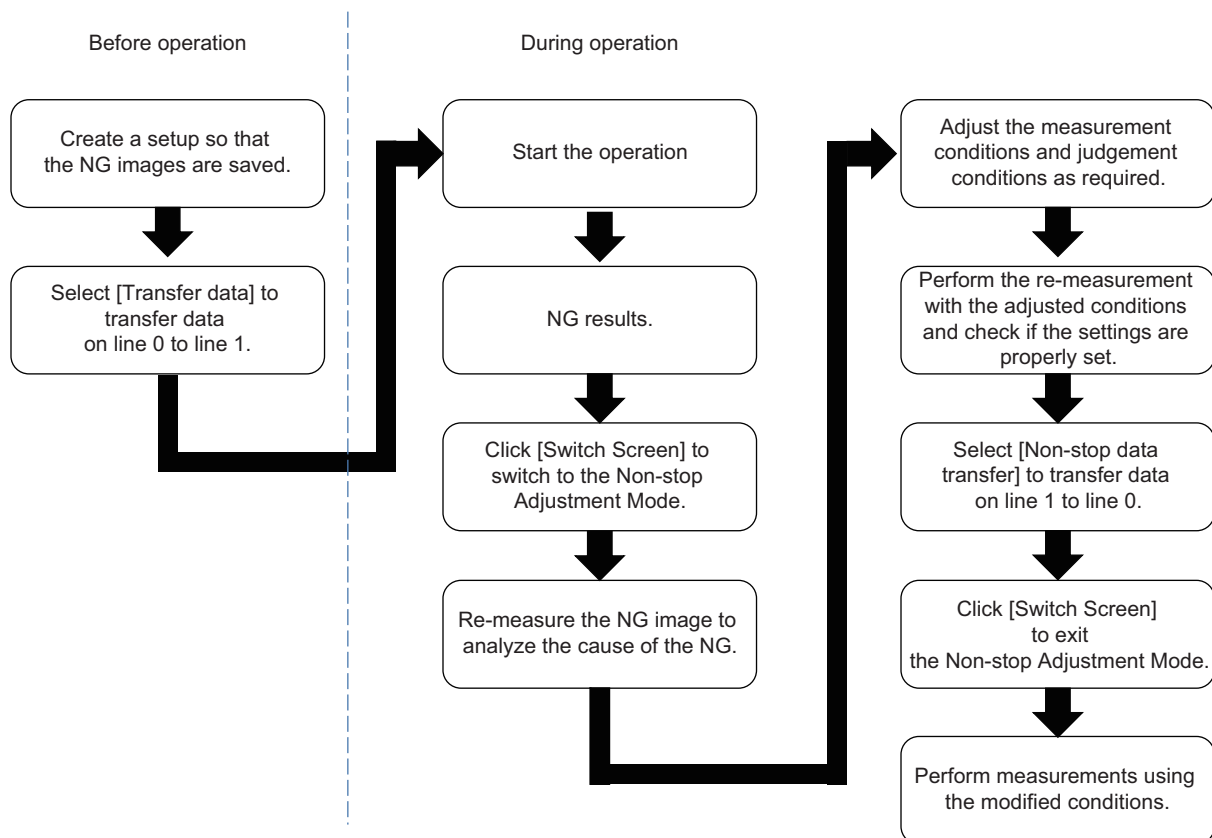

- 1** In the Main Window for line 0, select [Transfer data] from the [Function] menu.  
The settings for line 0 are transferred to line 1.  
Measurement does not stop and continues to be executed on line 0.
- 2** Click the [Switch Screen] button to display line 1 (Non-stop Adjustment Mode Window).  
The display for line 0 changes to the display for line 1. (The main display for line 1 is called the Non-stop Adjustment Mode Window.) This display change will not stop the measurements on images input to line 0.

- 3** Click the icon portion of the processing unit to adjust.  
To change the flow, use the [Edit flow] tool in the Toolbox Pane.  
The settings dialog box for the selected unit is displayed.

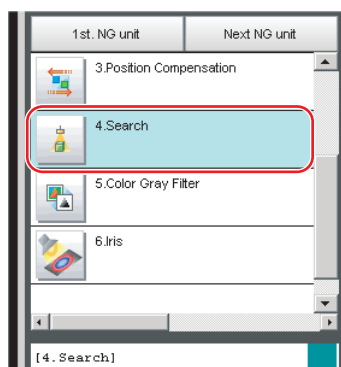

- 4** Modify the processing units.

- 5** Click [OK].

The settings dialog box closes and the display returns to the Main Window (layout 1).

If you need to modify the judgement conditions for more than one processing unit, repeat steps 3 to 4.

At this stage, none of the changes have been applied.

- 6** In the Main Window for line 1, select [Non-stop data transfer] from the [Function] menu.

The changes to the settings for line 1 are saved as the settings for line 0 without affecting the measurement.

- 7** Click the [Switch Screen] button to display the Main Window for line 0.

- 8** Click [Data Save] in the Function menu to save the settings.



### Important

- When you execute [Non-stop data transfer], the results in the Trend Monitor and Expression processing units are cleared.
- If you use an external command to switch scenes or scene groups, or change the settings of processing units while the Controller is in RUN mode, the results of those changes will not be applied when you change to line 1 (Adjustment Mode) in the Main Window.
- If you use the Non-stop Adjustment Mode after you change the scene group while the Controller is in RUN mode, you may overwrite the scene group data unintentionally.
- The only communications commands that are accepted during a non-stop data transfer are the measurement (parallel, non-procedure, or PLC Link) and continuous measurement (parallel only) commands.
- The larger the size of the scene group file, the longer the non-stop data transfer will take.
- The communications settings cannot be changed in Non-stop Adjustment Mode.
- Do not register a new Camera Image Input processing unit in the Non-stop Adjustment Mode Window.
- If there is not enough RAMDisk space, the Nonstop data transfer may not perform. Set the external storage device to save the Image logging, keep the RAMDisk space.
- Do not change the image mode for Non-stop Adjustment Mode.
- If you use image logging in Non-stop Adjustment Mode, the non-stop data transfer may become unavailable. To avoid this, set the trigger frequency so that it is longer than the logging time.



- Do not change the settings for image input processing items and do not change Camera parameters in the system settings in Non-stop Adjustment Mode.
- Do not select [Transfer data] during Line1 while Non-stop Adjustment Mode Window is running. You cannot measure during data transfer. Make sure to set [Transfer data] before running.
- When [Parallel Execute] in [Operation mode setting] of System setting is [ON], the measurement time might be longer since the Parallel processing effect is reduced.

The following processing items are supported in Non-Stop Adjustment Mode:

OK: Supported processing item, RST: Processing item with restricted support, ---: Unsupported processing item

Processing item	Support	Processing item	Support	Processing item	Support
Camera Image Input	---	Back Ground Suppression	OK	Transfer Position Data	OK
Camera Image Input FH	---	Brightness Correct Filter	OK	Calc Axis Move	OK
Camera Image Input FHV	---	Color Gray Filter	OK	Calc Axis Move by Multi-point	OK
Camera Image Input HDR	---	Extract Color Filter	OK	Detection Point	OK
Camera Image Input HDR Lite	---	Anti-Color Shading	OK	Camera Calibration	OK
Camera Switching	OK	Stripes Removal Filter II	OK	Data Save	OK
Measurement Image Switching	OK	Polar Transformation	OK	Conditional Branch	OK
Search	OK	Trapezoidal Correction	OK	End	OK
Flexible Search	OK	Machine Simulator	OK	DI Branch	---
Sensitive Search	OK	Image Subtraction	RST(*1)	Control Flow Normal	RST(*2)
ECM Search	OK	Advanced Filter	OK	Control Flow PLC Link	RST(*2)
EC Circle Search	OK	Panorama	OK	Control Flow Parallel	RST(*2)
Ec Corner	OK	Calculation	OK	Control Flow Fieldbus	RST(*2)
Ec Cross	OK	Line Regression	OK	Data Output	OK
Shape Search II	OK	Circle Regression	OK	Parallel Data Output	OK
Classification	OK	Precise Calibration	OK	Parallel Judgement Output	OK
Edge Position	OK	User Data	OK	Fieldbus Data Output	OK
Edge Pitch	OK	Get Unit Data	OK	Result Display	OK
Scan Edge Position	OK	Set Unit Figure	OK	Display Image File	OK
Scan Edge Width	OK	Get Unit Figure	OK	Display Last NG Image	OK
Circular Scan Edge Position	OK	Trend Monitor	---	OCR	OK
Color Data	OK	Image Logging	OK	OCR User Dictionary	OK
Gravity and Area	OK	Image Conversion Logging	RST(*3)	Conveyor Calibration	OK
Labeling	OK	Data Logging	RST(*3)	Conveyor Panorama Display	---
Label Data	OK	Elapsed Time	OK	Photometric Stereo Image Input	OK
Defect	OK	Wait	OK	Display image hold	OK
Precise Defect	OK	Focus	OK	Conditional execution (If)	OK
Fine Matching	OK	Iris	OK	Conditional execution (Else)	OK
Character Inspection	OK	Unit Macro	OK	loop	OK
Date Verification	OK	Unit Calculation Macro	OK	Loop suspension	OK
Model Dictionary	OK	Parallelize	OK	scene	OK
2D Codes	OK	Parallelize Task	OK	Select execution (Select)	OK
Circle Angle	OK	Statistics	---	Select execution (Case)	OK
Shape Search III	OK	Calibration Data Reference	OK	System information	OK

OK: Supported processing item, RST: Processing item with restricted support, ---: Unsupported processing item

Processing item	Support	Processing item	Support	Processing item	Support
Intersection	OK	Position Data Calculation	OK	Manual Position Setting	---
Barcode	OK	Stage Data	OK	2DCode II	OK
Glue Bead Inspection	OK	Robot Data	OK	Result output (I / O)	OK
Position Compensation	OK	Vision Master Calibration	---	Result output (Message)	OK
Filtering	OK	PLC Master Calibration	---		

\*1. The [Subt./Reg.] and [DI Register] measurement modes are not supported.

\*2. Sensor Controller in Non-Stop Adjustment Mode does not stand by.

\*3. Re-measured images in Non-Stop Adjustment Mode are logged.

## Standard (Operation Mode)

Normally, the sensor controller executes measurements, image logging, and image display in a designated order. The FH series/FZ5-800/1100/1200 series execute those processes with one of the CPU cores, and uses the rest of the cores for measurement processing. This ensures that measurements are always processed at maximum performance.

## 4-4-2 Parallel Processing

This function is exclusively for an FH series/FZ5-800/1100/1200 series.

There are two types of processing in the Parallel processing: Automatic parallelization and Manual parallelization.

The automatic parallelization automatically parallelize a measurement flow if [Parallel Execute] under [Operation mode setting] is turned ON.

The manual parallelization allows you to use the processing items for the parallel processings to freely edit a measurement flow after automatic parallelization. If you use the manual parallelization to separate a part of the measurement flow into multiple tasks and process each of these tasks in parallel reduces the processing time of the measurements.

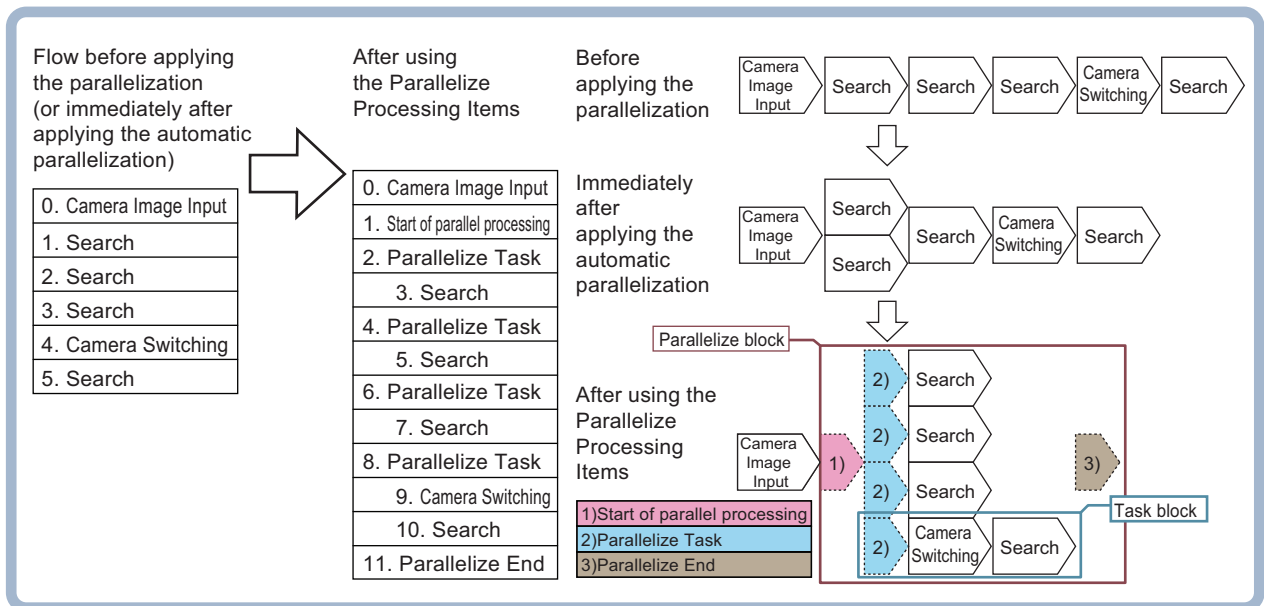

### Parallel Processing Settings (Automatic Parallelization)

Parallel processing is available when [Parallel Execute] is set to ON in the [Operation mode setting].

If you turn ON [Parallel Execute] under [Operation mode setting], the automatic parallelization automatically classify the type of processing items assigned to the measurement flow and parallelize the items of the same classification.

Refer to the following for details on the processing items that are automatically parallelized.

Refer to *Processing Items That Supports Automatic Parallelization* on page 4-37.

It is possible to affect each of Operation mode when Parallel processing is ON. Please if needed, refer to Refer to *The effect of Parallel processing on the Operation mode* on page 4-32.

## Parallel Processing Settings (Manual Parallelization)

If you use the FH series / FZ5-800/1100/1200 series Sensor Controller, you will need to convert the measurement flow to the parallelized flow in advance to specify the parallel processing. The conversion can be done by applying the automatic parallelization to the flow and use the parallel processing items. To specify this yourself, add parallel items as shown in the following measurement flow.

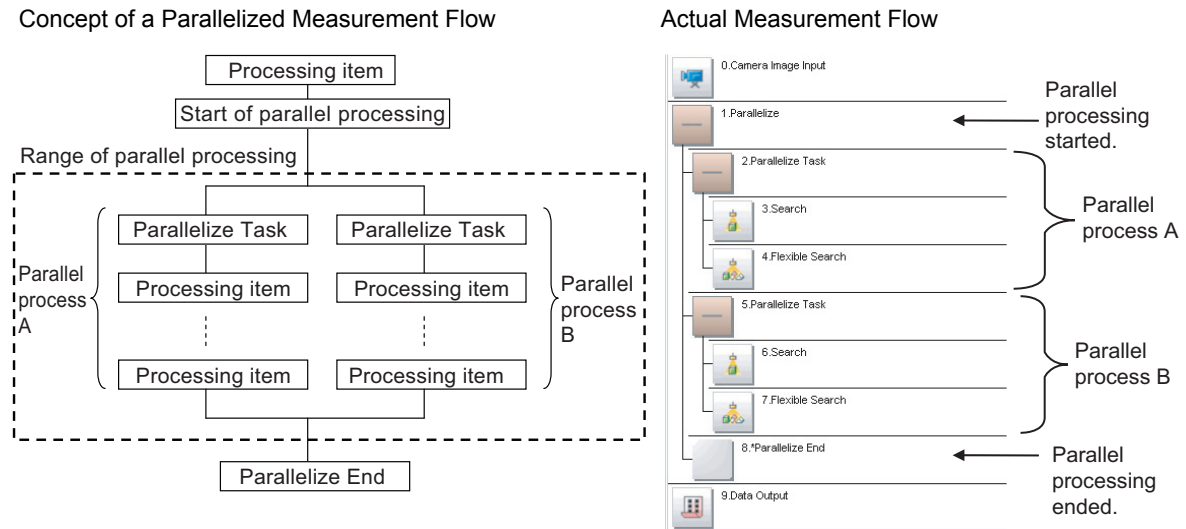

- The range from the Parallelize processing item to the Parallelize End processing item is called a *parallel block*.
- The processing range of the Parallelized Task processing item is called a *task block*. A task block is a group of measurement processes that are distributed among multi-core CPU. In a measurement flow, the task block is the range from the Parallelize Task processing item to the next Parallelize Task processing item, or the point that comes just before the Parallelize End processing item.



### Important

Operation mode and parallel processing are not apply to FZ5-L series/FZ5-600 series.



### Additional Information

If [Parallel process] is turned OFF in the [Operation mode setting], the measurement flow is processed in series in order of the unit numbers.

## ● Processing Items for Parallel Processing

You use the following three items.

Processing item category	Processing item name	Description
Measurement support processing items (Inspection and measurement support items)	Parallelize	Marks the beginning of a parallel processing range.
	Parallelize Task	Gives the range to be parallelized.
	Parallelize End	Marks the end of a parallel processing range.

Refer to the *Vision System FH/FHV/FZ5 Series Processing Item Function Reference Manual* (Cat. No. Z341) for information on the parameters for the above items.

● **Programming Parallel Processing Items**

- Always use the Parallelize and Parallelize End processing items in pairs.
- Do not place processing items between the Parallelize processing item and Parallelize Task processing item. Any processing units that are placed in this position will not be executed.
- Always insert the Parallelize Task processing item between the Parallelize processing item and Parallelize End processing item.
- If you program a branch under a Parallelize Task processing item, make sure the branch stays within the range of the Parallelize Task processing item.

**Specific Example of Parallel Processing**

You can use the automatic parallelization in combination with the manual parallelization to parallelize the following example flow. First, use the automatic parallelization to parallelize three inspection items, 3. Search, 5. Search, and 7. Search. Then, use the manual parallelization to parallelize two inspection items, 9. Camera Switching and 10. Search.

Example:

Parallelization processing application status	Measurement flow	Flow of processing	Remarks												
Before applying the parallelization (automatic parallelization: OFF, manual parallelization: not applied)	<table border="1"> <tr><td>0. Camera Image Input</td></tr> <tr><td>1. Search</td></tr> <tr><td>2. Search</td></tr> <tr><td>3. Search</td></tr> <tr><td>4. Camera Switching</td></tr> <tr><td>5. Search</td></tr> </table>	0. Camera Image Input	1. Search	2. Search	3. Search	4. Camera Switching	5. Search								
0. Camera Image Input															
1. Search															
2. Search															
3. Search															
4. Camera Switching															
5. Search															
Applying the automatic parallelization only	Same as above.		When using four CPU cores on the FH sensor controller												
Applying the automatic parallelization in combination with the manual parallelization	<table border="1"> <tr><td>0. Camera Image Input</td></tr> <tr><td>1. Start of parallel processing</td></tr> <tr><td>2. Parallelize Task</td></tr> <tr><td>3. Search</td></tr> <tr><td>4. Parallelize Task</td></tr> <tr><td>5. Search</td></tr> <tr><td>6. Parallelize Task</td></tr> <tr><td>7. Search</td></tr> <tr><td>8. Parallelize Task</td></tr> <tr><td>9. Camera Switching</td></tr> <tr><td>10. Search</td></tr> <tr><td>11. Parallelize End</td></tr> </table>	0. Camera Image Input	1. Start of parallel processing	2. Parallelize Task	3. Search	4. Parallelize Task	5. Search	6. Parallelize Task	7. Search	8. Parallelize Task	9. Camera Switching	10. Search	11. Parallelize End		
0. Camera Image Input															
1. Start of parallel processing															
2. Parallelize Task															
3. Search															
4. Parallelize Task															
5. Search															
6. Parallelize Task															
7. Search															
8. Parallelize Task															
9. Camera Switching															
10. Search															
11. Parallelize End															

## Restrictions

### ● The effect of Parallel processing on the Operation mode

- Measurement processing speed will be faster because all cores are used for one measurement when Parallel processing is ON.  
However, processing time may vary greatly due to CPU core scrambling.  
This may cause a delay in the timing of logging operations and display updates.
- One CPU core is used at one measurement processing when Parallel processing is OFF. There will be less variation in processing speed because separate cores will be assigned to measurement and other processes.
- It is possible to affect each of Operation mode functions when Parallel processing is ON as described below.

Operation mode	Parallel processing is ON
Standard (Operation mode)	The time for one measurement is fastest for all modes.
Double Speed Multi-input	Highest measurement count per time unit.
Non-stop Adjustment	It is possible the measurement on the Non-stop Adjustment side or transfer of the Non-stop data to affect to the measurement of the running side.
Multi-line Random trigger	Measurement of the other line can affect the measurement processing time.

## ● Flow of Images

- The image at the start of parallel processing is passed on to the next item for use in each task block.
- The image for the start of parallel operation is also the image that is used after the Parallelize End processing item.

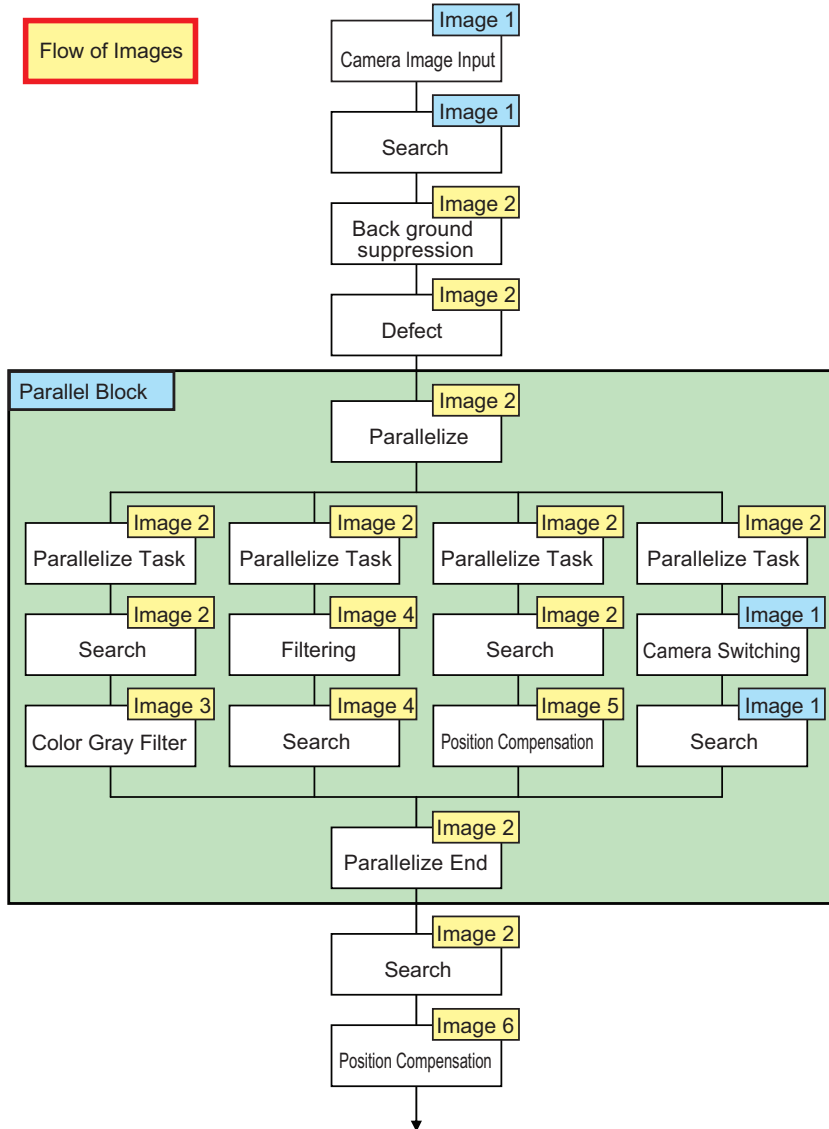

- Note that you cannot assign any Camera Image Input processing item within task blocks. To change the Camera image, you must use the Camera Switching processing item and set a different Camera number.

## ● Nesting

Parallel blocks can be nested.

Example:

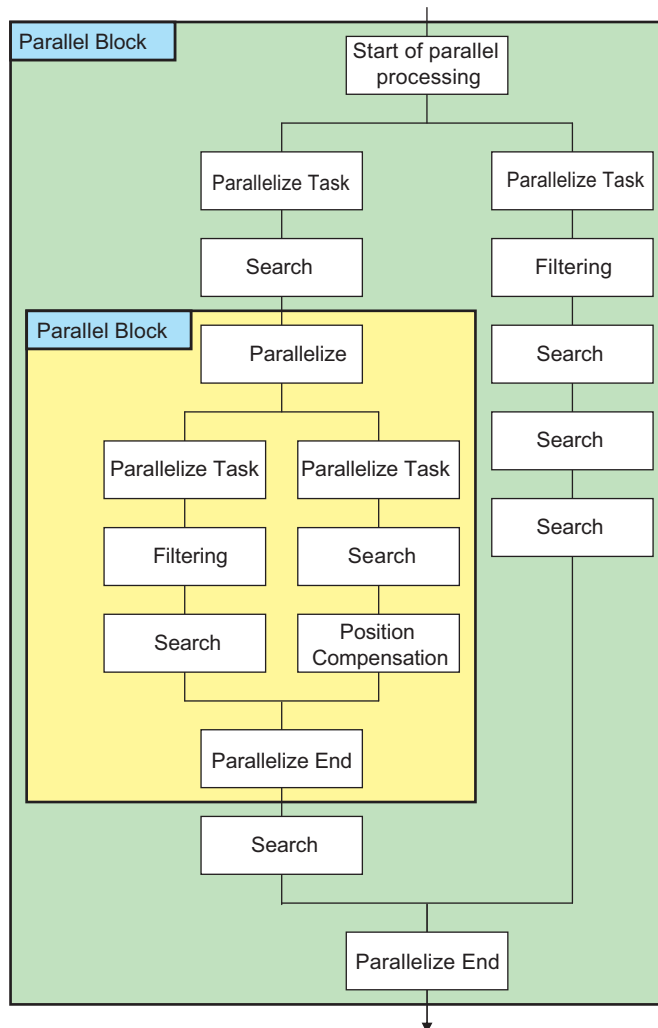

## ● Processing Order

The processing order for Parallelize Task processing items is not defined. Do not program a measurement flow that relies on a specific processing order of Parallelize Task processing items.

## ● Transaction Times

Parallel processing may not be able to reduce transaction times as effectively as expected due to the processing time of each task, and the number of CPU cores. Before commissioning the system, always check the transaction time with the actual measurement flow and image.

## ● Inserting Camera Image Input Processing Items

- Do not insert a Camera Image Input processing item inside the range of a Parallelize Task processing item. To use a different Camera image for a measurement under a Parallelize Task processing item, use the Camera Switching processing item inside the range of the Parallelize Task processing item.
- When inside the range of a Parallelize Task processing item, do not reference an image that is processed under a different Parallelize Task processing item.



## ● Getting and Setting Data

- Do not get or set user data and system data inside task blocks.
- When inside the range of a Parallelize Task processing item, do not get or set unit data from a processing unit that is under a different Parallelize Task processing item.
- Do not input or output to the same file from a processing unit that is under a different Parallelize Task processing item.

## ● Accessing the Same File

Do not input or output to the same file that is used for data logging in a task block.

## Setting Procedures

This section describes the settings that are required to enable parallel processing.

### ● Setting the Operation Mode

Use the following procedure to set [Parallel processing] or ON in the [Operation mode setting].

- 1 In the Main Window (layout 0), select [Tool] – [System Settings].
- 2 In the [Startup setting], click the [Operation mode] tab.
- 3 Select [ON] for [Parallel Execute].

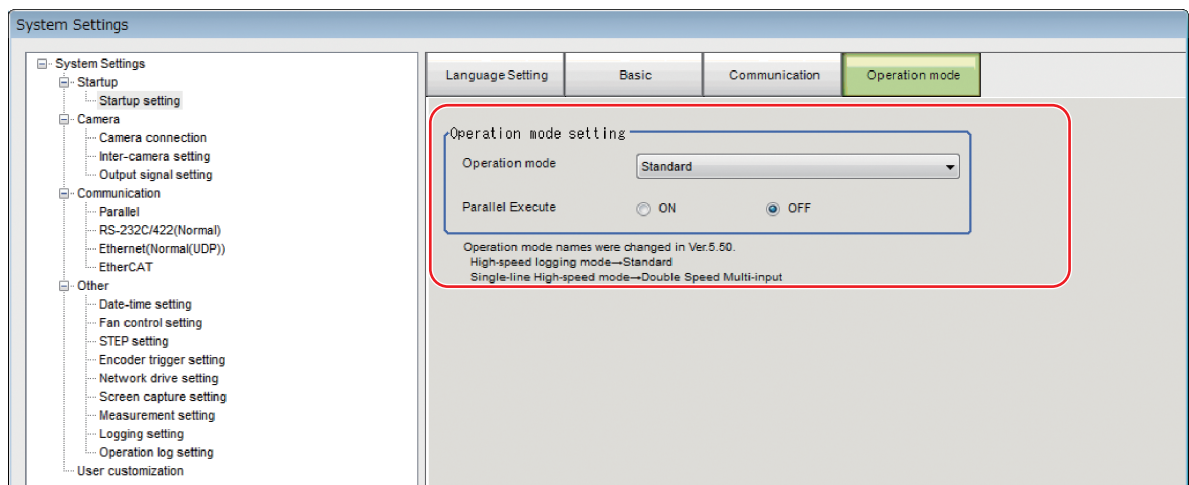

### Additional Information

It is possible to affect each of Operation mode when Parallel processing is ON. Please if needed, refer to *The effect of Parallel processing on the Operation mode* on page 4-32.

Major effects for each operation mode are as follows.

- [Standard] (Operation Mode): Logging processing may take longer.
- Double Speed Multi-input Mode: Measurement time may be inconsistent, although the volume of measurements that can be handled per increment of time is the same.
- Non-stop adjustment mode: If a remeasurement is performed on the Setup Window, processings on Run Window may take longer.
- Multi-line random-trigger mode: Measurement on each line may affect the measurement time on other lines.

## ● Editing the Measurement Flow

- 1** In the Main Window (layout 0), select [Function] – [Edit Flow].
- 2** Drag the following processing items from under [Inspection and measurement support items], or click the [Insert] button.
  - Parallelize
  - Parallelize Task
- 3** Program the processing items to execute in parallel between two Parallelize Task processing items.

Example:

Fully Expanded

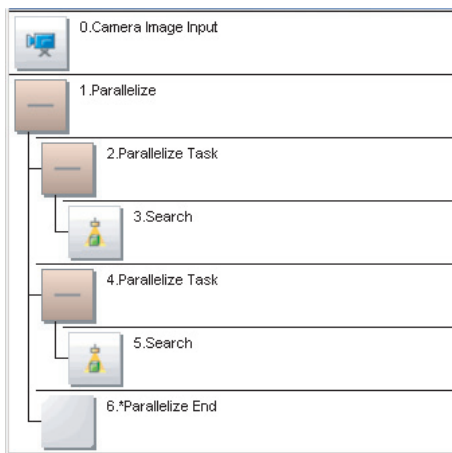

Parallel Blocks Collapsed

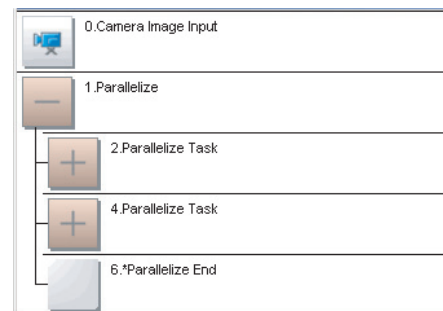

The Parallelize processing item is the parent, and everything up to the Parallelize End processing item is a child.

Additionally, the Parallelize Task processing item is the parent, and everything up to the step just before the next Parallelize Task processing item or the Parallelize End processing item is a child.

There is no settings dialog box for Parallelize processing items.

The Parallelize End processing item is not displayed in the list of items. (It is registered as a set with the Parallelize processing item).

## ● Precautions on Flow Editing

- Editing operations on parallel blocks and task blocks, such as register, move, delete, copy, and paste, and unit save and load operations, are performed on the parallel block as a group.
- You cannot delete a Parallelize End processing item by itself. It is deleted as a set with the Parallelize processing item.
- You cannot paste or move items within the same parallel block.
- If a processing item in a parallel block is set to reference data in a processing unit that is inside the block, and if that block is copied, the reference will be replaced with a reference to the unit in the block at the copy destination.  
References to a unit that is outside the parallel block will be retained.
- You cannot move, paste, or load a task block outside of its parallel block.

## ● Processing Items That Supports Automatic Parallelization

The following table lists the processing items that support the automatic parallelization.

Processing item	Parallelize processing	Processing item	Parallelize processing	Processing item	Parallelize processing
Camera Image Input	---	Back Ground Suppression	---	Transfer Position Data	---
Camera Image Input FH	---	Brightness Correct Filter	---	Calc Axis Move	---
Camera Image Input FHV	---	Color Gray Filter	---	Calc Axis Move by Multipoint	---
Camera Image Input HDR	---	Extract Color Filter	---	Detection Point	---
Camera Image Input HDR Lite	---	Anti-Color Shading	---	Camera Calibration	---
Camera Switching	---	Stripes Removal Filter II	---	Data Save	---
Measurement Image Switching	---	Polar Transformation	---	Conditional Branch	---
Search	OK	Trapezoidal Correction	---	End	---
Flexible Search	OK	Machine Simulator	---	DI Branch	---
Sensitive Search	OK	Image Subtraction	---	Control Flow Normal	---
ECM Search	OK	Advanced Filter	---	Control Flow PLC Link	---
EC Circle Search	OK	Panorama	---	Control Flow Parallel	---
Ec Corner	OK	Calculation	---	Control Flow Fieldbus	---
Ec Cross	OK	Line Regression	---	Selective Branch	---
Shape Search II	OK	Circle Regression	---	Data Output	---
Classification	OK	Precise Calibration	---	Parallel Data Output	---
Edge Position	OK	User Data	---	Parallel Judgement Output	---
Edge Pitch	OK	Set Unit Data	---	Fieldbus Data Output	---
Scan Edge Position	OK	Get Unit Data	---	Result Display	---
Scan Edge Width	OK	Set Unit Figure	---	Display Image File	---
Circular Scan Edge Position	OK	Get Unit Figure	---	Display Last NG Image	---
Circular Scan Edge Width	OK	Trend Monitor	---	OCR	OK
Color Data	OK	Image Logging	---	OCR User Dictionary	---
Gravity and Area	OK	Image Conversion Logging	---	Conveyor Calibration	---
Labeling	OK	Data Logging	---	Conveyor Panorama Display	---
Label Data	---	Elapsed Time	---	Photometric Stereo Image Input	---
Defect	OK	Wait	---	Display image hold	---
Precise Defect	OK	Focus	OK	Conditional execution (If)	---
Fine Matching	OK	Iris	OK	Conditional execution (Else)	---
Character Inspection	OK	Unit Macro	---	loop	---
Date Verification	---	Unit Calculation Macro	---	Loop suspension	---
Model Dictionary	---	Parallelize	---	scene	---
2D Codes	---	Parallelize Task	---	Select execution (Select)	---
Circle Angle	OK	Statistics	---	Select execution (Case)	---
Shape Search III	---	Calibration Data Reference	---	System information	---
Intersection	OK	Position Data Calculation	---	Manual Position Setting	---
Barcode	OK	Stage Data	---	2DCode II	---
Glue Bead Inspection	OK	Robot Data	---	Result output (I / O)	---
Position Compensation	---	Vision Master Calibration	---	Result output (Message)	---
Filtering	---	PLC Master Calibration	---		



### Additional Information

Some processing items are processed in parallel as individual units.

## ● Troubleshooting

Symptom	Correction
An error message is displayed on the Console Window.	Refer to the error message list.
Insertion position for a unit to parallelize	Do not place items between the Parallelize item and Parallelize Task item. Any process units that are placed in that position will not be executed.
Insertion position of a parallelize processing items	Always insert the Parallelize Task processing item between Parallelize and Parallelize End processing items.
Setting the Parallelize processing item	Always use Parallelize and Parallelize End processing items in pairs.
Camera Image Input processing items are not being processed in parallel	Do not insert Camera Image Input processing items under Parallelize Tasks processing items. To use a different Camera image for a measurement under a Parallelize Task processing item, use the Camera Switching processing item under the Parallelize Task processing item.
Getting and setting the image from more than one Parallelize Task processing item	Do not reference an image that is processed under a different Parallelize Task processing item.
Getting and setting data from more than one Parallelize Task processing item	Do not get or set figure data from a processing unit that is inside the range of a different Parallelize Task processing item. Do not get or set unit data from a processing unit that is inside the range of a different Parallelize Task processing item.
Accessing files from under more than one Parallelize Task processing item	Do not input or output to the same file from a processing unit that is under a different Parallelize Task processing item.
Conditional branching under a Parallelize Task processing item	If you need to branch the processing items inside the range of a Parallelize Task processing item, make sure the branch stays within the range of the Parallelize Task processing item.
Processing order of Parallelize Tasks	The processing order for the Parallelize Task processing units is not defined. Do not program a measurement flow that relies on a specific processing order of Parallelize Task processing items.
Improving processing speed with Parallelize Task processing item	Parallel processing may not reduce transaction times as much as expected due to the processing time of each task, and the number of CPU cores. Before commissioning the system, always check the transaction time with the actual measurement flow and image.
Getting and setting system data under Parallelize Task processing items	Do not get or set user data and system data within the range of a Parallelize Task processing item.

## 4-5 Checking the Camera Connections: [Camera Connection]

You can check whether a Camera is connected. There are no settings.

- 1 In the Main Window, select [System settings] – [Camera] – [Camera Connection] from the [Tool] menu.

The Camera Connection Settings View is displayed.

- 2 Check the connection status.

If a Camera is connected, the model name of the connected Camera will appear next to the Camera number.

If the [Disconnect] is displayed even though a Camera is connected, there could be a failure or a disconnected line. Check the physical connection.

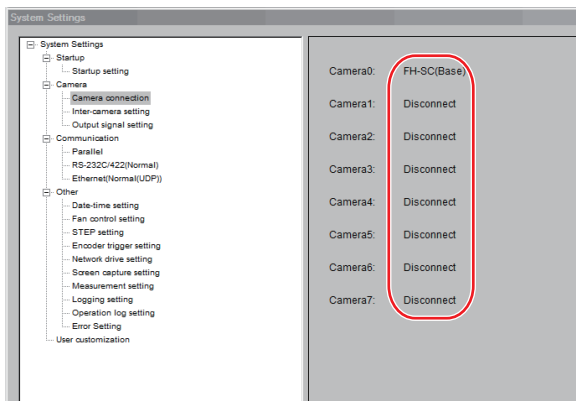

- 3 Click the [Close] Button.

## 4-6 Setting the Trigger Delay [Inter-camera Setting]

This setting is used to set the delay time from when the STEP signal for the input trigger is received to when the shutter is triggered. You can use this to prevent mutual interference caused by the lighting when more than one Camera is used, or as a simple trigger delay when only one Camera is used.



### Important

Do not perform next camera image input processing before STGOUT signal output is completed. STGOUT signal may not be output.

Perform camera image input processing after STGOUT signal output completion, or set the STEP-camera delay, STEP-STGOUT delay and STGOUT pulse width so that the electronic flash operates synchronizing with the exposure time.



### Additional Information

Set the delay between STEP and STGOUT of STGOUT pulse width, use the [Electronic flash setting] in [Camera Image Input] or [Camera Image Input FH].

Refer to *Electronic Flash Setting of the Vision System FH/FHV/FZ5 Series Processing Item Function Reference Manual* (Cat. No. Z341).

### ● Trigger Delay Setting [Delay between Cameras]

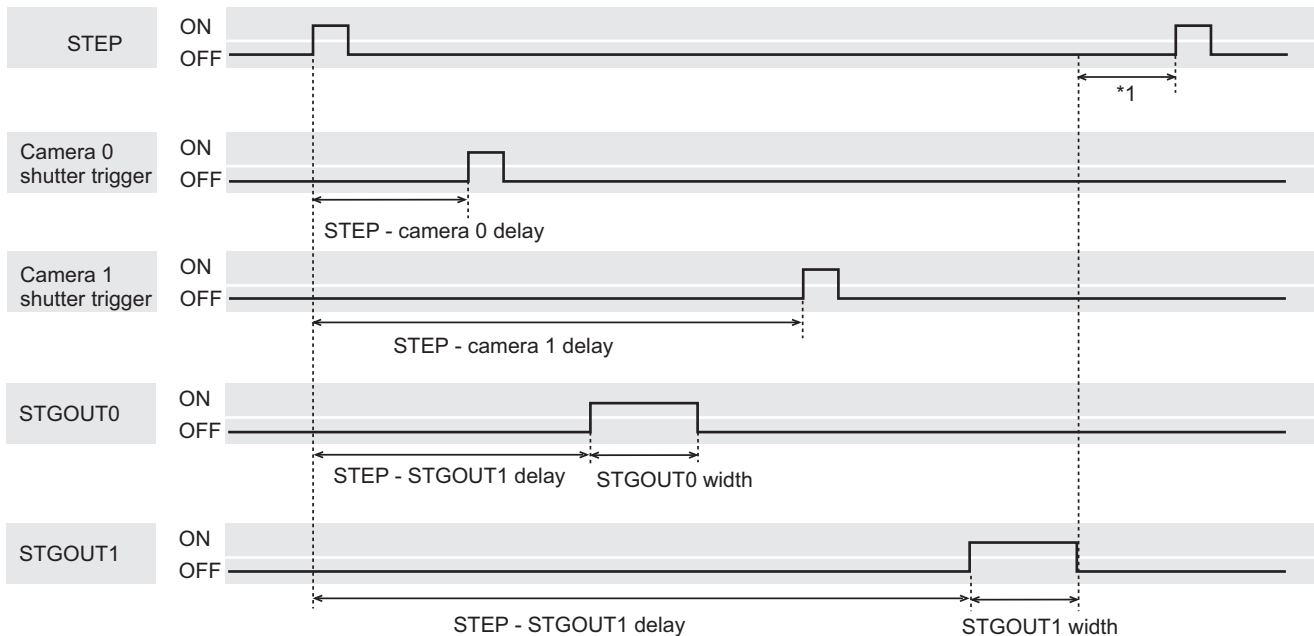

\*1. Do not enter the next STEP until STGOUT pulse turns OFF.

Set the STEP-Camera delay, STEP-STGOUT delay and STGOUT pulse width so that the electronic flash operates synchronizing with the exposure time.

- 1 In the Main Window, select [System settings] – [Camera] – [Inter-camera setting] from the [Tool] menu. The Inter-camera Settings View is displayed.

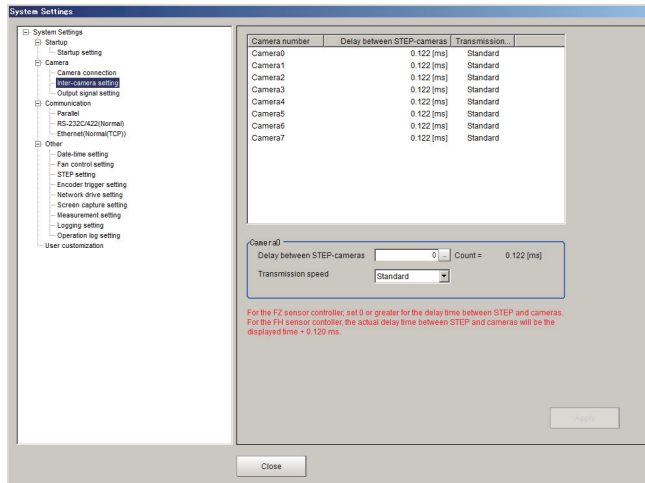

- 2 Click a camera number to set the delay between STEP-cameras and then specify the delay count value.

Item	Set value [Factory default]	Description
Delay count between STEP-cameras	<ul style="list-style-type: none"> <li>FH series Sensor Controller: -4 to 511 [0] (1 count is 30 μs)</li> <li>FZ5 series Sensor Controller: 0 to 511 [0] (1 count is 30 μs)</li> </ul>	<p>Sets the delay time from when the STEP signal is received to when exposure begins for the selected Camera.</p> <p>The delay time differs in FH series / FZ5 series.</p> <ul style="list-style-type: none"> <li>Delay time of FZ5 series Sensor Controller: The time displayed for STEP-camera delay time is delay count between STEP-camera × 30 μs + 122 μs</li> <li>Delay time of FH series Sensor Controller: When using cameras other than FH-S□05R, the time displayed for STEP-camera delay time is (STEP-camera delay counts × 30 μs + 122 μs) + 120 μs. When using the FH-S□05R camera, the time displayed for STEP-camera delay time is (STEP-camera delay counts × 30 μs + 122 μs) + 470 μs. When using the FH-S□21R camera, the time displayed for STEP-camera delay time is (STEP-camera delay counts × 30 μs + 122 μs) + 1123 μs.</li> </ul>
Transmission speed	[Standard] or High speed	<p>When you connect a camera that supports High speed mode using a camera cable shorter than 5m, image input time can be shortened by selecting [High speed] for frame rate.</p> <p>For details about frame rate values, refer to the Instruction manual for the Camera.</p> <p>The following cameras support [High speed]:</p> <ul style="list-style-type: none"> <li>FH-SC02/FH-SM02</li> <li>FH-SC04/FH-SM04</li> <li>FH-SC12/FH-SM12</li> <li>FH-SCX/FH-SMX</li> <li>FH-SCX05/FH-SMX05</li> <li>FH-SCX12/FH-SMX12</li> <li>FH-SC21R/FH-SM21R</li> </ul>



### Additional Information

---

- FH-1000/3000/5000 series:  
Maximum number of settable camera is 8.
  - FH -L series/FZ5 series/FZ5-L series:  
Maximum number of settable is 4, camera 0 to camera 3.
  - FH series Sensor Controller:  
Connecting the camera by Medium Configuration, the image input time will be shorten.  
Refer to *3-1 Preparing the Controller and Cameras* on page 3-2.
-



## 4-7 Setting the SHTOUT Signal [Output Signal Settings]

This function is exclusively for an FH series Sensor Controller.

This setting affects the SHTOUT signal that is output when the exposure of the Camera ends. You can detect when the exposure ends with the SHTOUT signal to minimize the time to hold the workpieces still for taking images. This allows you to move the workpiece or the Camera immediately after the exposure ends.

### Important

- You cannot use the STGOUT signal and SHTOUT signal at the same time. Select the signal to output depending on the application.
- [Output signal setting] is effective only with FH series.
- SHTOUT signal: SHTOUT0 to SHTOUT7 is tied to the Line number, not camera number. When use the Multi-line random-trigger mode, confirm the Line number, and then use SHTOUT signal.
- [Output Signal Settings] apply only to the FH series Sensor Controller. In FZ5 series Sensor Controller, you cannot use the SHTOUT signal regardless of what is set in [Output Signal Settings].

- 1 In the Main Window, select [Camera] – [Output Signal Setting] from the [Tool] menu. The settings dialog box for the output signals is displayed.

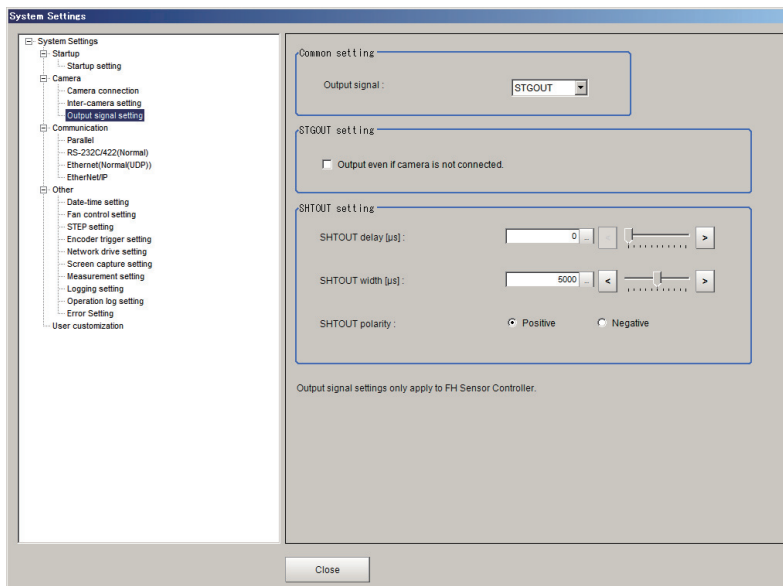

### Additional Information

- If the [Output Signal Selection] is set to [SHTOUT], the SHTOUT signal is output according to the settings in the [Individual Line Settings]. If the [Output Signal Selection] is set to STGOUT, the STGOUT signal is output according to the settings in the [Electronic flash setting] for a camera input processing item.
- If you are using the Camera Image Input HDR, or Camera Image Input HDR Lite processing item, the SHTOUT signal is output for every image that is taken.

- If you are using the Through Image Mode in the Main Window, the SHTOUT signal is output for every through image that is taken.

## 2 Select the output signal in the [Common setting].

Parameter	Set value [Factory default]	Description
Output signal	[STGOUT]	The STGOUT signal line is used for the STGOUT signal. If you selected STGOUT, you cannot use the SHTOUT output signal.
	SHTOUT	The STGOUT signal line is used for the SHTOUT signal. If you selected SHTOUT, you cannot use the STGOUT output signal.

## 3 Select the output method of STGOUT signal in the [STGOUT setting]. Please uncheck if you select [SHTOUT] in the [Output signal].

Parameter	Set value [Factory default]	Description
Output without a Camera connection	<ul style="list-style-type: none"> <li>• [Unchecked]</li> <li>• Checked</li> </ul>	<ul style="list-style-type: none"> <li>• Unchecked Only STGOUT signal with which a Camera is connected is output.</li> <li>• Checked STGOUT signals that are not connected with cameras will output, too. This setting can be used to change the brightness of the light quickly. Use the [Electronic flash setting] in [Camera image input FH] to configure the STGOUT signal.</li> </ul>



### Important

- The setting of [Output even if camera is not connected] can be used only with FH series. This can not be used with FZ5 series.
- The STGOUT signals that are applicable with the setting [Output even if camera is not connected] are as follows.
  - FH-1000/3000/5000 series: STGOUT 0 to 7
  - FH-L series: STGOUT 0 to 3
- The setting for Multi-line Random-trigger Mode is as follows.
  - [Output signal setting]
    - Configurable only in Output signal setting of Line 0. For other lines settings for Line 0 are commonly applied.
  - [Output even if camera is not connected]
    - Selectable for each line.
- If a check is placed for [Output without a Camera connection] , set the pulse width for the [Camera Image Input FH] processing item of corresponding STGOUT signal (STGOUT0 to STGOUT7)  
Refer to *Electronic Flash Setting in the Camera Image Input FH in the Vision System FH/FHV/FZ5 Series Processing Item Function Reference Manual (Cat. No. Z341)*.
- STGOUT0 to STGOUT7 is tied to the camera connector number of the sensor controller, not the camera number. When you use CameraLink Medium Configuration or the Multi-line random-trigger mode, confirm the camera connector number that corresponds to the camera number of Sensor Controller.

**4** Set SHTOUT for each line in the [Line setting] area.

Parameter	Set value [Factory default]	Description
SHTOUT signal delay [ $\mu$ s]	[0] to 1,000	Sets the delay time from when exposure is completed to when the SHTOUT signal turns ON in increments of 10 $\mu$ s.
SHTOUT signal pulse width [ $\mu$ s]	40 to 10,000 [5,000]	Sets the time to output the SHTOUT signal in increments of 10 $\mu$ s.
SHTOUT signal pulse polarity	<ul style="list-style-type: none"> <li>• [Positive]</li> <li>• Negative</li> </ul>	Set the polarity of the SHTOUT signal. Positive: The SHTOUT signal changes from OFF to ON when the exposure ends. Negative: The SHTOUT signal changes from ON to OFF when the exposure ends.

**Important**

Do not perform next camera image input processing before SHTOUT signal output is completed. SHTOUT signal may not be output.

Perform camera image input processing after confirming SHTOUT signal output completion, or set the SHTOUT signal delay and SHTOUT signal pulse width so that the SHTOUT signal output is completed before camera image input processing.

**5** Click the [Close] Button.

## 4-8 Setting the Conditions Related to Communications

---

For details, refer to *Vision System FH/FHV/FZ5 Series User's Manual for Communications Settings* (Cat. No. Z342).

## 4-9 Setting Date/Time [Date/Time Settings]

Confirm that the date and time on the built-in calendar are correct, and make corrections if they are not. The log data dates and times are set based on contents set here.



### Precautions for Correct Use

For the FHV series, the date and time setting used for the measurement ID is reset to the initial value each time it is activated. Therefore, you need to set the date and time again with a communication command or this procedure every time the power is turned on.

For details of communication commands for each communication module, refer to *Vision System FH/FZ5 Series User's manual for Communications Settings (Cat. No. Z342)*.

### Setting Date/Time

- 1 In the Main Window, select [System settings] - [Other] - [Date-time setting] from the [Tool] menu. The [Date-time setting] dialog box is displayed.
- 2 Set the current date and time.



- 3 Click [Apply].

## Setting Date/Time with Remote Operation Tool

- 1 In the Main window of the Remote operation tool, click [System settings] - [Other] - [Datetime setting] from [Tool] menu.

The setting screen on the Sensor Controller is displayed on the remote operation PC.

Current date : 2018年10月  
 Current time : 13:34:31

Controller date-time setting

Date-time of the controller : 2018/10/11 13:34:28

Set the current date-time  
 Set the specified date-time

Date : 2018/10/11 Time : 13:34:18

Date-time setting



### Additional Information

For the "Controller Date/Time", the date and time of the Sensor Controller is displayed at the time of opening the screen.

- 2 Set the current date and time.

Set item	Set value [Factory default]	Description
Controller Date/Time	Set the current date and time.	Select to set the date and time of the PC running the remote operation tool.
	Set a specified date and time.	Select to set the specified date and time.

- 3 Click [Date/Time setting].

The date and time are set to the Sensor Controller.

## 4-10 Setting Fan Control [Fan Control Setting]

This procedure describes how to set the rotation speed of the Controller fan.

FZ5-600 series/FZ5-800/1100/1200 series



### Additional Information

The default setting is for low rotation. Use fast rotation when using the system in a high-temperature environment between 45 and 50°C.

- 1 In the Main Window, select [System settings] – [Other] – [Fan control setting] from the [Tool] menu.

The [Fan control setting] dialog box is displayed.

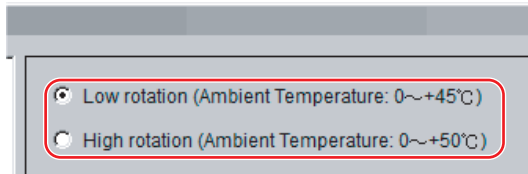

- 2 Select a fan setting.

Set value [Factory default]	Description
<ul style="list-style-type: none"> <li>• [Low rotation (Ambient temperature: 0 to +45°C)]</li> <li>• High rotation (Ambient temperature: 0 to +50°C)</li> </ul>	Select the rotation speed of the fan.

- 3 Click the [Apply] button.



### Important

The fan control setting is disabled for the FZ5-L series.

# 4-11 Setting the Pulse Width for the STEP Input Detection [STEP Signal Filter Setting]

You can set a filter as a countermeasure against STEP input chattering and to prevent operation malfunctions due to noise.

## Filter Set Value of 100 $\mu\text{s}$ (Default Value)

The STEP signal is detected as being ON at the point it is ON continuously for at least 100  $\mu\text{s}$ , and measurement begins at that point. Accordingly, STEP signal detection is delayed by an amount of time equivalent to the set filter value. Also, when turning from ON to OFF, the OFF filter fixed at 500  $\mu\text{s}$  is activated and the STEP signal is detected as OFF when it is OFF for at least 500  $\mu\text{s}$ .

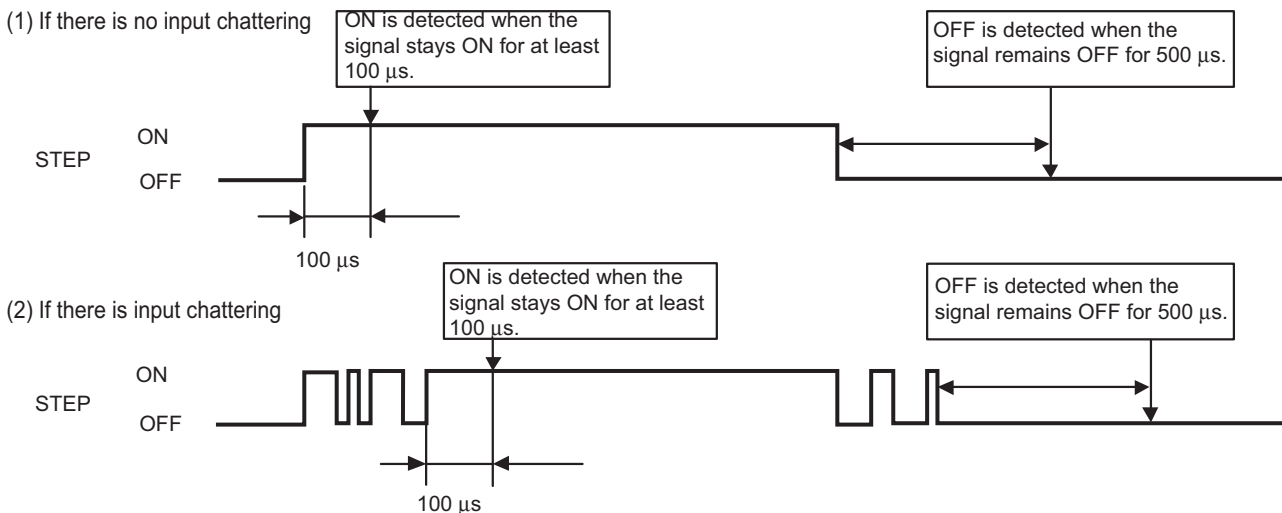

- 1 In the Main Window, select [System settings] – [Other] – [Controller] – [STEP setting] from the [Tool] menu.
- 2 Set the filter width in the [STEP setting] area.

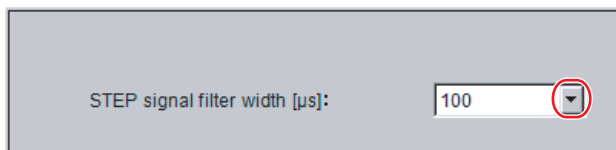

Parameter	Set value [Factory default]	Description
STEP signal filter width [ $\mu\text{s}$ ]	<ul style="list-style-type: none"> <li>• [100]</li> <li>• 200</li> <li>• 300</li> <li>• 400</li> <li>• 500</li> </ul>	Set the filtering width.



### Important

If you use Multi-line Random-trigger Mode for an FH-series Controller, the value for the STEP signal filter on line 0 is applied to all lines.



## 4-12 Setting Encoder Trigger [Encoder Trigger Setting]

- 1 In the Main Window, select [System setting] – [Other] – [Encoder trigger setting] from the [Tool] menu.

Use Encoder trigger  
 Encoder input type : Open collector  
 Resolution[pulse/rotation] : 0  
 (0.0000[pulse/degree])  
 Count rotations with pulse Z

- 2 Set the target encoder.

Parameter	Set value [Factory default]	Description
Use encoder trigger	<ul style="list-style-type: none"> <li>• Checked</li> <li>• [Unchecked]</li> </ul>	Set whether to use an encoder trigger.
Encoder input type	<ul style="list-style-type: none"> <li>• [Open collector]</li> <li>• Line driver</li> </ul>	Select the output format of the encoder to be connected.
Resolution [pulse/rotation]	[1] to 65535	Set how many pulses equal one rotation. Set this parameter according to the resolution of the encoder.
Count rotations with pulse Z	<ul style="list-style-type: none"> <li>• Checked</li> <li>• [Unchecked]</li> </ul>	When this is checked, pulse Z is used to determine whether a full rotation is made. When this is unchecked, a full rotation is determined by whether the number of pulses on phase A has reached the resolution of phase A.

**3** Set the advanced settings for the trigger as necessary.

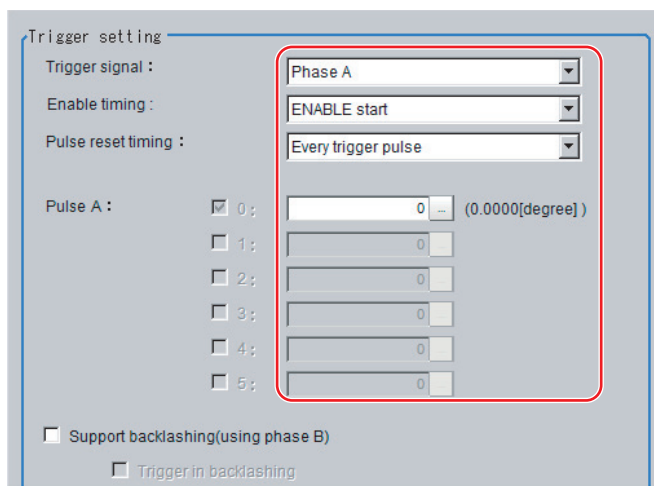

Parameter	Set value [Factory default]	Description
Trigger signal	[Phase A] Phase Z	Set the phase to use as the trigger signal.
Phase A		
Enable timing	<ul style="list-style-type: none"> <li>[ENABLE start]</li> <li>STEP start</li> </ul>	Set the timing for starting the pulse count. ENABLE start: Counts the pulses input during the measurement trigger receipt period. STEP start: The pulses are not counted even during the measurement trigger receipt period until the STEP signal is input.
Pulse reset timing	<ul style="list-style-type: none"> <li>[Every trigger pulse]</li> <li>Every rotation (Pulse Z)</li> <li>Every STEP</li> </ul>	Set the timing for resetting. When [ENABLE start] is specified for [Enable timing], you can select [Every trigger pulse] or [Every rotation (Pulse Z)]. When [STEP start] is specified for [Enable timing], you can select [Every trigger pulse] or [Every STEP]. When [Every rotation] is set, multiple pulses can be set for phase A.
Phase A trigger	[0] to 65535	Set how many pulses it takes to produce a trigger.
Support backlashing (using phase B)	<ul style="list-style-type: none"> <li>Checked</li> <li>[Unchecked]</li> </ul>	Set whether the rotation direction is detected.
Trigger in backlashing	<ul style="list-style-type: none"> <li>Checked</li> <li>[Unchecked]</li> </ul>	Set to produce a trigger during reverse rotation.
Phase Z		
Enable timing	<ul style="list-style-type: none"> <li>[ENABLE start]</li> <li>STEP start</li> </ul>	Set the timing for starting the pulse count. ENABLE start: Counts the pulses input during the measurement trigger receipt period. STEP start: The pulses are not counted even during the measurement trigger receipt period until the STEP signal is input.
Pulse reset timing	<ul style="list-style-type: none"> <li>[Every trigger pulse]</li> </ul>	Set the timing for resetting the pulse count of phase Z. Every trigger pulse: Reset the pulse count of phase Z each time the Sensor Controller outputs a trigger.
Phase Z trigger	[1] to 1023	Set how many pulses it takes to produce a trigger.



**Important**

The encoder trigger setting is disabled for the FZ5-L series.

## 4-13 Setting Network Drive [Network Drive Setting]

You can save logging images to an external device, such as a network-connected computer with a shared folder, using a network drive.

You can also load setting data saved in a network drive into the Controller.

If you register a shared folder on the network drive, the network drive connected to the [Select file] or [Select folder] dialog box of the FH/FHV/FZ5 software will be displayed.

Set up the network drive according to your computer environment.

- 1 Click [Tool]-[System settings]-[Other]-[Network drive settings].
- 2 Click [Reconnect] if you want to reconnect Network drive, Click [Edit] if you want to edit it.  
For [Reconnect] and [Edit], refer to as followings.

### ● About [Reconnect]

By clicking [Reconnect], you can reconnect the Network drive without restarting the Sensor Controller.

The following are example situations for the use of [Reconnect].

- Network drive communication is filed at Sensor Controller's startup.
- Network drive communication is disconnected while Sensor Controller is running.
- Network drive is changed while Sensor Controller is running.

Setting procedure of [Reconnect] is as followings.

- 1 Select Network drive that you want to reconnect.

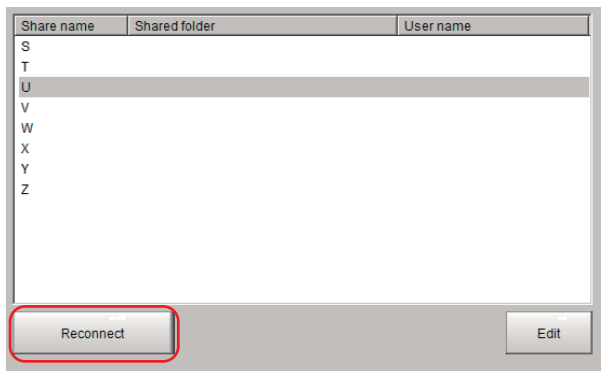

- 2 Click [Reconnect].

### Important

- Click [Reconnect] after completion of saving or loading of Network drive.  
If you click [Reconnect] while the Network drive is running, the network drive file may be corrupted.
- Make sure to do the following when changing the User name and Password of a network drive on the FZ5-L series/FZ5-600 series.
  - 1) Click [Shared folder], [User name], and [Password]. Then click [Reconnect].  
Note that the Reconnect will fail in this time.
  - 2) Enter new [Shared folder], [User name], and [Password].
  - 3) Click [Reconnect] again.

● **About [Edit]**

You can edit Network drive's name e.t.c.

Setting Procedure of [Edit] is the following.

- 1** Select Network drive that you want to edit.

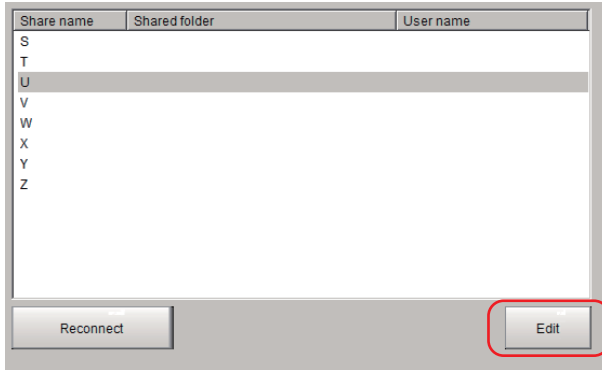

- 2** Click [Edit].

- 3** Enter Share name, Shared folder, User name and Password.

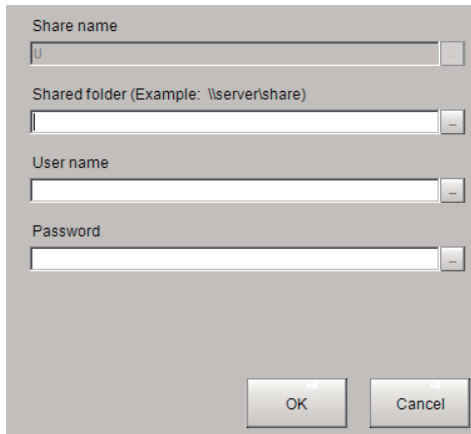

Parameter	Set value [Factory default]	Description
Share name	S,T,U,V,W,X,Y,Z	This is the name to be recognized by the Controller as a network drive. Only 1 unit can be connected. For FZ5-L series/FZ5-600 series, the shared name is displayed in the Network folder. For FH series/FZ5-800/1100/1200 series, a drive letter such as E:, F:, G:, or H: is displayed. (Example) For network Drive S, the following drive names are used to access communication commands, macro programs, and so on. • FZ5-L Series FZ5-600 series: /Network/S/ • FH series/FZ5-800/1100/1200 series: S:/
Shared folder	---	Specify the shared folder name. Create a folder in advance on a computer that has a DNS resolved name on the network, and specify this as the shared folder name. For example, if the host name (computer name) is VISION and the shared name is COMMON, specify a name such as \\VISION\COMMON.
Username	---	Enter the user name and the password to access the network drive. If you do not know the user name or the password, contact the device network administrator.
Password	---	

#### 4 Click [Apply].

Edited information is saved to the Sensor Controller.

It's information will be available with restarting Sensor Controller.



#### Important

Click [Apply] after saving or reading of Network drive. If you click it while Network drive is running, Network drive's file could be given a damage.



#### Important

- If images and data are logged to a network drive, the use of the multi-input function and other heavy measurement loads on the Controller may slow down communications and cause logging errors. In this case, set the measurement takt time so that there is some leeway.
- If many drives are set as network drives, it may require a greater amount of time to start the Controller.
- Do not pull out the LAN cable while the Controller is accessing the network drives.
- Start the Controller when the network drives are ready. Connections cannot be established if the network drives are not ready when the Controller is started.
- If there is no access to a network drive for a certain amount of time, the connection will be automatically cut off depending on the network drive setting at the connection target. Make sure that the setting at the connection target is not set to automatic disconnection.
- Dates and Times of the Updates of the Files Created at Network Logging  
If the time zone of the external device is different from the time zone setting of the Controller [GMT-08:00 Pacific Time (US & Canada): Do not automatically adjust clock for Daylight Saving Time], the date and time actually written may be different from the date and time of the file update. Adjust the time zone of the external device to match that of the Controller.

- For Network drive communication with the FH series/FZ5-800/1100/1200 series, you can specify IP address instead of Host name on the Shared file setting. On the other hand, in the case of FZ5-L series/FZ5-600 series, Network drive communication cannot be apply even if you specify IP address.
  - For FH series/FZ5-800/1100/1200 series, you can set WINS server.
  - For FZ5-L series/FZ5-600 series, WINS server setting depends on your network environment.
-

## 4-14 Setting Screen Capture [Screen Capture Setting]

---

Refer to 3-5 *Capturing Screen Images* on page 3-32.

## 4-15 Setting the Conditions that are Related to Operation during Measurement [Measurement Conditions]

You can change the following items of operation during measurement.

- Operation when the next STEP signal is input during measurement
- Whether the scene group is saved when you change to another scene group
- Setting for when the scene switch time is short and switching cannot be detected by the external device

**1** In the Main Window, select [System settings] – [Other] – [Measurement settings] from the [Tool] menu.

The [Measurement settings] dialog box is displayed.

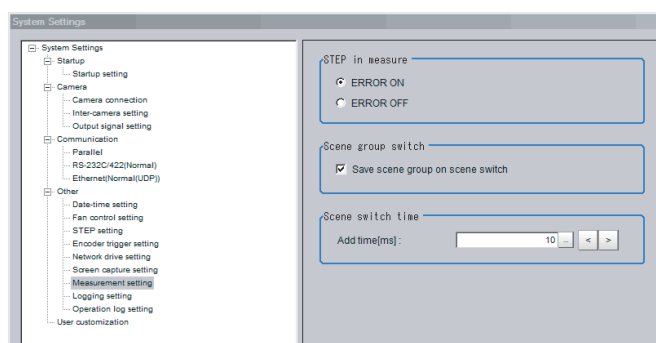

**2** Set each item as necessary.

Item	Set value [Factory default]	Description
STEP in measure	[ERROR ON] or ERROR OFF	Specify the status of the ERROR signal (READY signal is OFF) while Camera Image Input cannot be used, i.e. during capturing, and STEP signal is input.
Save scene group on switch scene	<ul style="list-style-type: none"> <li>• [Checked]</li> <li>• Unchecked</li> </ul>	Set the operation to perform when you change to another scene group. Set whether the scene group should be saved when changing to another scene group. The scene group switching time can be reduced if the selection of this check box is cleared, but if the power supply is turned OFF without saving changes to settings, the changes will be lost.
Scene switch time, Add time [ms]	0 to 1000 [10]	The BUSY signal is turned ON during scene switching. When this time is short and the change from ON to OFF cannot be detected by the external device, you can increase the time that the BUSY signal is ON. Set in units of 1 ms. Click [<] or [>] to increment the time in 5 ms from the displayed value.



### Important

When you select Through image, and even if you select [ERROR ON], ERROR signal is not output when the STEP is input while READY signal is OFF.





### Additional Information

---

The [Save scene group on switch scene] is linked to the setting for the [Scene group switch] dialog box. Settings specified later override the previous settings.

**Refer to 7-2 *Switching the Scene or Scene Group* on page 7-4.**

---

- 3** Click [Apply].

## 4-16 Setting Logging Conditions [Logging Setting]

---

Refer to 6-3-1 *Logging Measurement Values and Measurement Images [Data Logging/Image Logging]* on page 6-8.

## 4-17 Setting Operation Log [Operation Log Setting]

---

Set the operation log related issues.

Refer to *10-4-1 Using the Operation Log* on page 10-40 and *10-4-2 Operation Log Format* on page 10-43.

## 4-18 Setting the Operation at Error [Error Operation Setting]

Normally, when an error occurs, an error signal is output to the communication module in use and measurement is stopped. Using this function, you can select whether to output an error signal or show a dialog when a specific error occurs for each line.

- 1 On the main window, click [Tool] -[System setting] -[Other] -[Error Setting].
- 2 Valid error type selections and current settings are displayed.

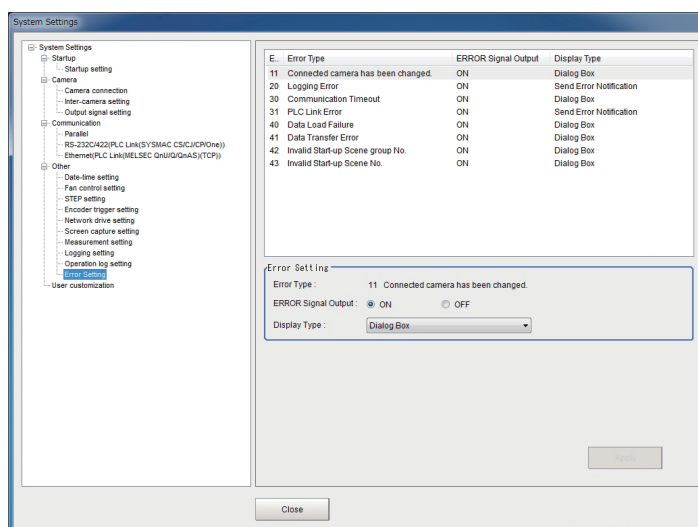

### Additional Information

For error messages and troubleshooting, refer to *11-1 Error Messages and Troubleshooting* on page 11-2.

- 3 Select [Error Type] to set the error operation on the error select window.

#### 4 Set the error operation on the Error Setting area.

Setting item	Setting value [Factory default]	Description
Error Type	—	Displays the Error No, and Error Type selected on the Error select window.
ERROR Signal Output	<ul style="list-style-type: none"> <li>• [ON]</li> <li>• OFF</li> </ul>	Select the Radio button to output the error signal when selected Error Type occurs.
Display Type		Select the notification or operation of error when specified error type occurs. The default operation differs by the error type.
	<ul style="list-style-type: none"> <li>• No Error Notification</li> <li>• Send Error Notification</li> <li>• Dialog Box</li> <li>• Dialog Box (Clear ERROR Signal)</li> </ul>	<p>Do not display any error notification on the window when the selected Error Type occurs.</p> <p>No Error Notification: Displays the error information on the Information Pane when the selected Error Type occurs.</p> <p>Send Error Notification: This [Send Error Notification] operation is limited to only Logging Error and PLC Link Error. For other error types, the display operation follows the setting of [Dialog Box]. For Information Pane, refer to the Main Window 8-2-1 Main Window (Layout 0): Adjustment Window (Default) on page 8-11.</p> <p>Dialog Box: Displays the error information on the window when the selected Error Type occurs. When you select [ON] in [ERROR Signal Output], the error output remains on even if you close the dialog box.</p> <p>Dialog Box (Clear ERROR Signal): Displays the error information on the window as a dialog box when the selected Error Type occurs. When you select [ON] in [ERROR Signal Output], the error output is turned OFF when you close the dialog box.</p>



#### Additional Information

A dialog is displayed when [Dialog Box (Clear ERROR Signal)] occurs. Show an example when a logging error of Line 0 occurs. Click [OK] to close the dialog.

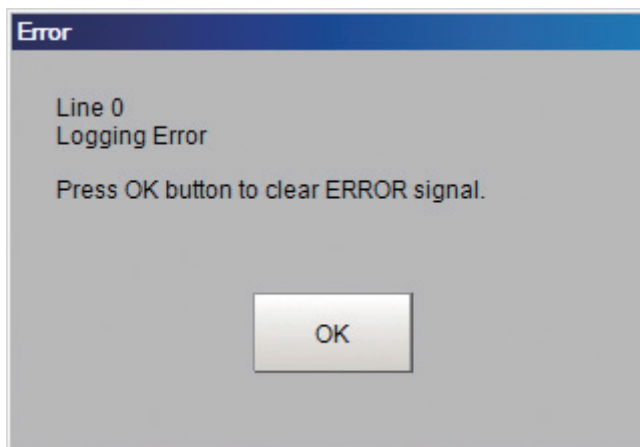

## 4-19 Setting Character Code using Macro/Variable Function [Macro/Variable Function Setting]

Set the character code to use when handling character strings with Macro/variable function. You can prevent it by changing the settings when garbling occurred in Macro/variable function.

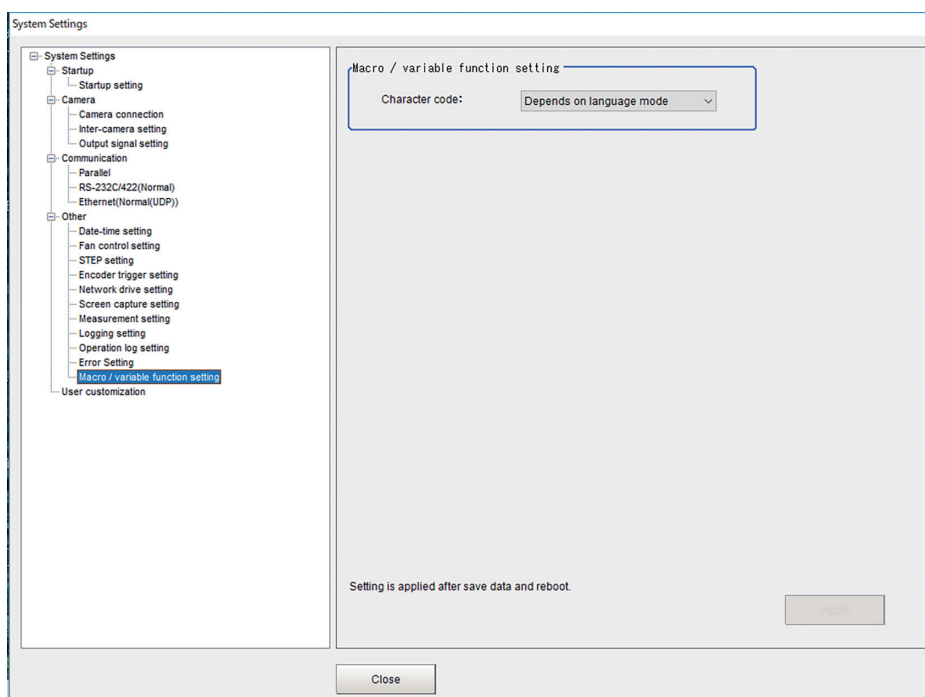

- 1 On the Main Window, click [Tool] – [System setting] – [Other] – [Macro/Variable function setting].
- 2 Set the character code.

Setting item	Setting value [Factory default]	Description
Character code	<ul style="list-style-type: none"> <li>• [Depends on language mode]</li> <li>• UTF-8</li> </ul>	<p>A character code of the language set in “Language setting” in “System Settings” is used when “Depends on language mode” is set.</p> <p>For Ver. 6.10 or earlier, “Depends on language mode” is only supported.</p> <p>When “UTF-8” is set, UTF-8 is used as the character code.</p>



### Important

Set the character code to UTF-8 when “Vietnamese” or “Polish” is selected in the “Language setting”.

Garbling may occur when the character code is set to “Depends on language mode”.

# 5

## Creating Measurement Scenes

This section explains the methods for saving and loading settings and image data.

---

<b>5-1</b>	<b>What Is a Scene?</b>	<b>5-2</b>
<b>5-2</b>	<b>Creating a Scene</b>	<b>5-5</b>
<b>5-3</b>	<b>Editing Processing Units in Scenes</b>	<b>5-7</b>
<b>5-4</b>	<b>Displaying and Checking Processing Branches in a Scene</b>	<b>5-10</b>
<b>5-5</b>	<b>Using Variables to Edit the Flow [TDM Editor]</b>	<b>5-14</b>
5-5-1	Edit Flow Screen	5-14
5-5-2	Editing Processing Units in a Scene	5-24
5-5-3	Editing Scenes	5-34
5-5-4	Using Variables	5-43

## 5-1 What Is a Scene?

Processing items for use with various measurement objects and measurement objectives are provided in the Sensor Controller. By combining and executing these processing items, measurement adapted to the purpose can be implemented. A combination of processing items is called a scene. Scenes can be easily created by combining processing items that are suited to the measurement purpose from the list of processing items that are provided.

### Editing Scenes

Set a processing item for each unit in the flow.

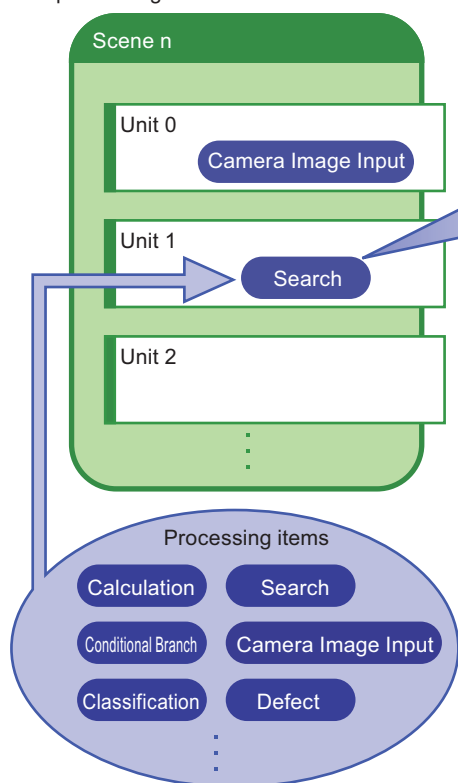

### Editing Units

Set the conditions for each unit that forms the flow.

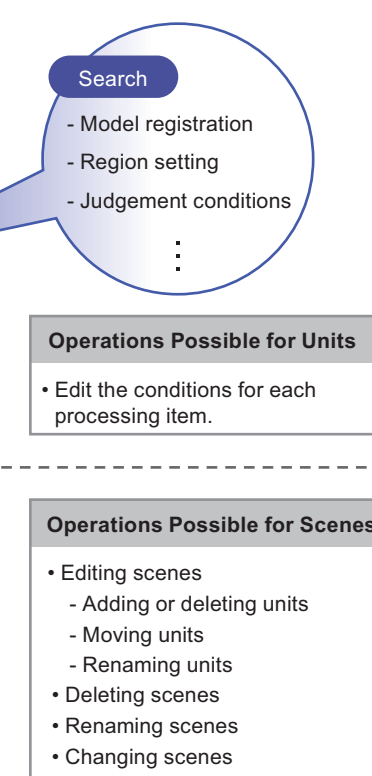

## Changing Processes Using Scenes

You can create more than one scene. For example, if you create scenes for each measurement object, such as scene 0 to inspect label ABC and scene 1 to inspect label XYZ, you can change the process smoothly just by changing the scene whenever the measurement object or measurement objective has changed.

Refer to 7-2 *Switching the Scene or Scene Group* on page 7-4.

Normally you can set up to 128 scenes. If you require more than 128 scenes, you can create scene groups to easily manage them.

*Increasing the Number of Scenes in a Group to more than 128 Scenes [Conversion Scene Group Data Tool]* on page 7-12 allows you to create a scene group that has more than 129 scenes.

Refer to 7-1 *What Is a Scene Group?* on page 7-2.

## Example of a Scene

The processing items registered to a scene are called processing units. In the edit flow window where you create scenes, select the processing items required for measurement and add them to the flow.



The number at the top of the processing unit is called the unit number. When the measurement trigger is input, processing is executed in the order of the processing unit numbers.

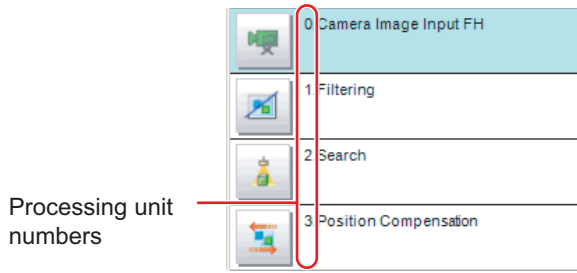

Example: Normal Measurement

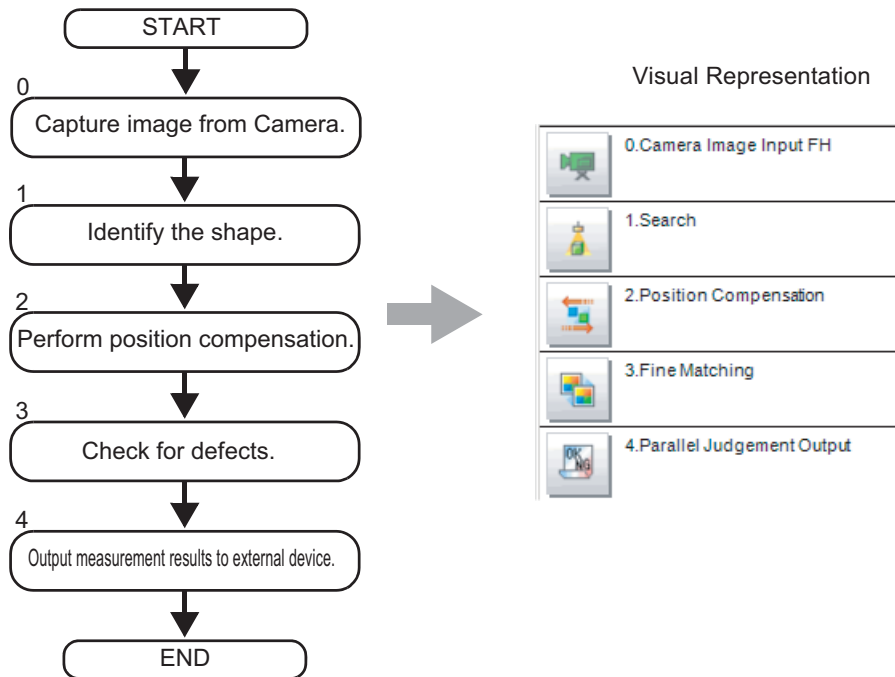

**Additional Information**

By default, a [Camera Image Input] or [Camera Image Input FH] processing item is set for unit 0.

Example: Adding Position Compensation for Two Measurement Objects in the Same Field of View

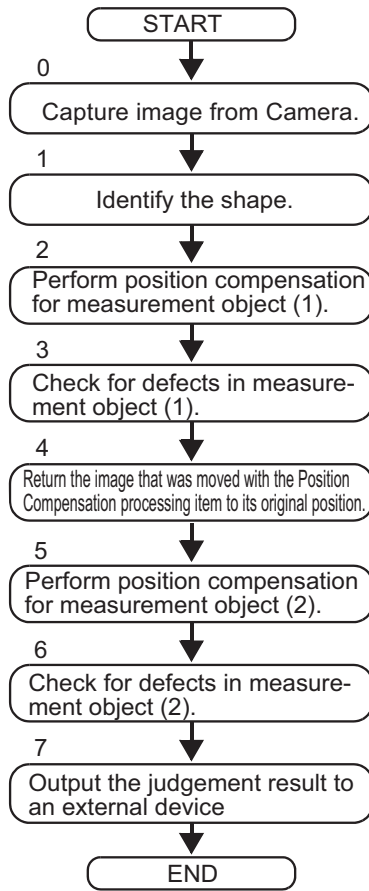
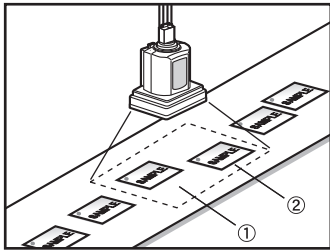

Visual Representation



Example: Determining the Product Type from the Image and Branching Later Inspection Conditions According to the Product Type (Branch Processing)

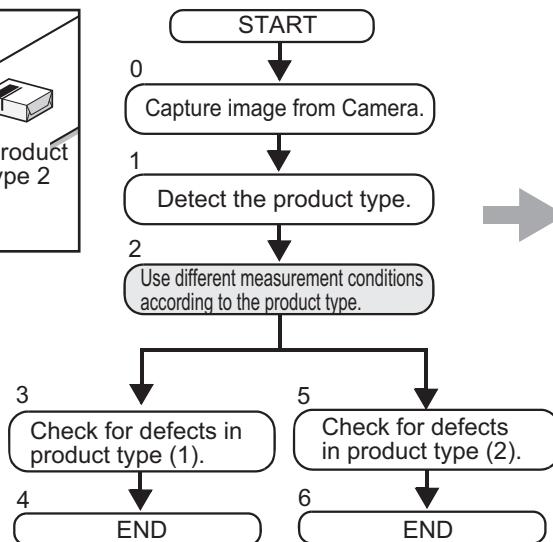
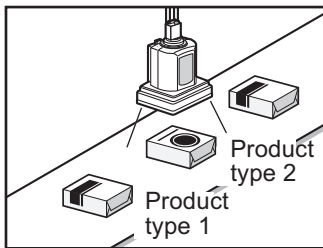

Visual Representation

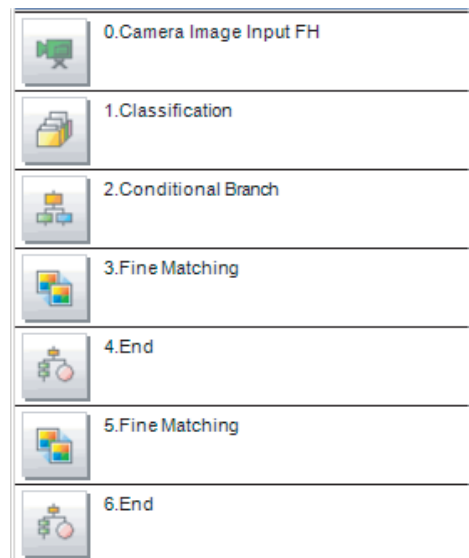

## 5-2 Creating a Scene

This section explains how to add processing units to a scene.

- 1 In the Main Window (layout 0), display the scene to edit.  
Refer to 7-2 *Switching the Scene or Scene Group* on page 7-4.
- 2 Click the [Edit flow] button.  
The edit flow window is displayed.
- 3 Select the processing item to add from the processing item tree.
- 4 Click the [Append] button.  
The selected processing item is added at the bottom of the unit list (flow).

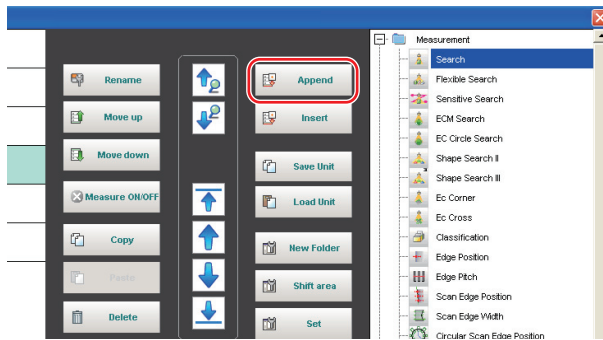
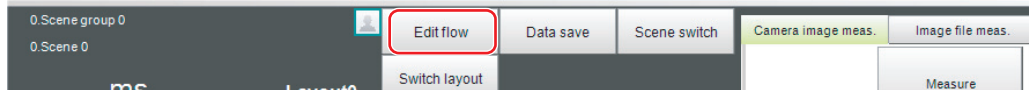

- 5 Add another processing unit if necessary. Repeat the steps after 3.



### Additional Information

- Limitations on Settings  
The number of image input processing items that can be used is limited.  
Refer to A-13 *About Limits on the Number of Image Input Processing Items Used* on page A-39.

**6** Either click the icon of the processing unit to be set or click the [Set] button.

The Properties Tab Page is displayed. Set detailed conditions. The displayed contents depend on the processing item.

Property setting buttons

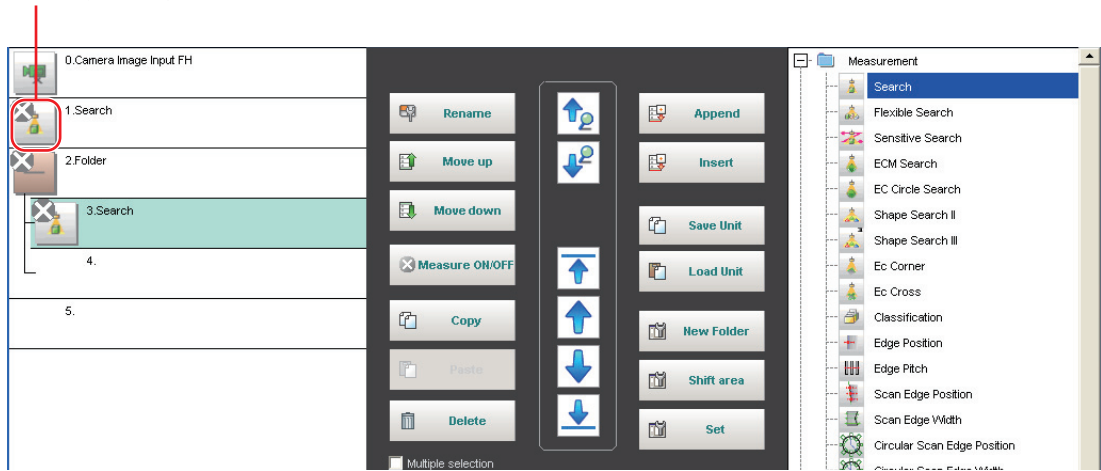









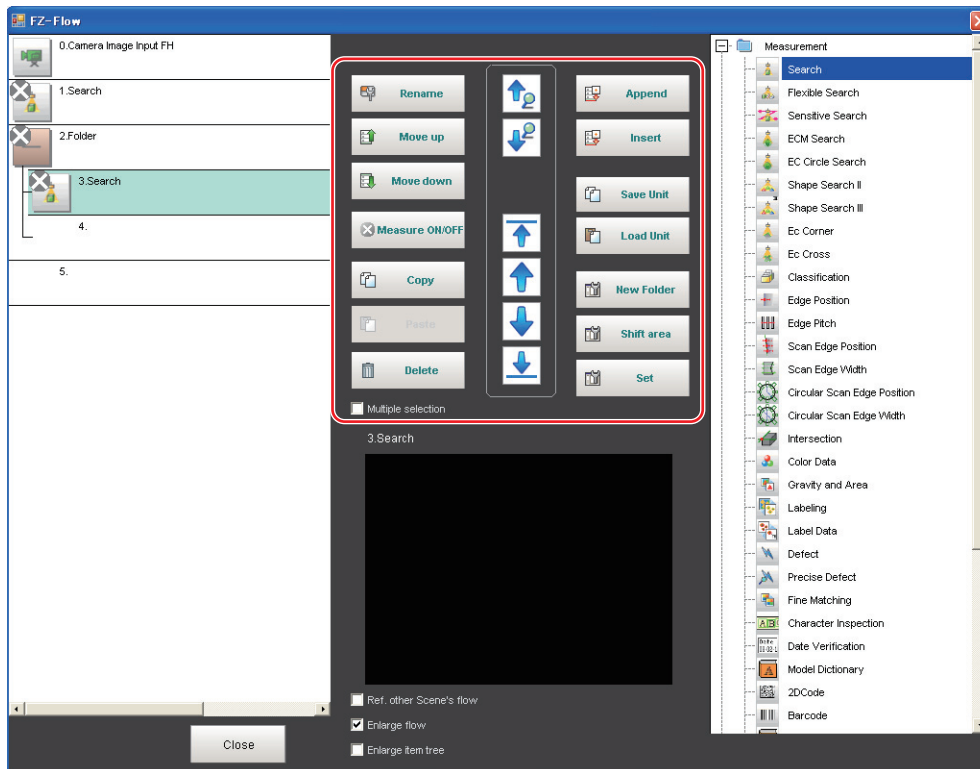



**7** Set the conditions.



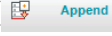

The displayed contents depend on the processing item.

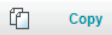
## 5-3 Editing Processing Units in Scenes

You use the edit buttons in the edit flow window to arrange processing units in a scene, or to delete processing units.

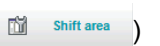
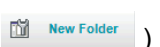
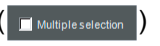

- Searching for a Processing Unit (  ) (  )  
 Searches the measurement flow for the processing item that is selected in the processing item tree.
- Selecting a Processing Unit (  ) (  ) (  ) (  )  
 Automatically selects the processing unit at the very top or bottom of the unit list, or a processing unit at any position in between.
- Adding a Processing Units at a Specified Position (  Append ) (  Insert )  
 Adds or inserts a processing unit at the bottom position of the scene or another specified position.
- Moving a Processing Unit (  Move up ) (  Move down )  
 Moves a processing unit within a scene to change the processing order.
- Copying and Pasting Processing Units (  Copy ) (  Paste )  
 Copies and pastes a processing unit while maintaining the same settings.
- Saving Processing Unit Data to a File (  Save Unit )  
 Saves the data for a selected processing unit to a file.

- Loading Processing Unit Data (  )  
Loads the data for a processing unit from a file.
- Deleting a Processing Unit (  )  
Deletes a processing unit from the scene.
- Renaming Processing Units (  )  
Renames a processing unit in the scene. Unit names must begin with a character other than ° (semi-voiced sound symbol) and ̀ (voiced sound symbol). Also, unit names cannot consist of only a single-byte number, only a "+", or only a ".".
- Setting the Details of a Processing Unit (  )  
Sets the properties of a processing unit in the scene.
- Shift Area (  )  
Changes the related figure data in one batch.
- New Folder (  )  
Used when multiple processing units are managed as a group.
- Handling Multiple Processing Units (  )  
Used when processing units are copied or deleted together. Click the [Multiple selection] button to display the check boxes for the processing items. The selected processing units can be manipulated as a group.

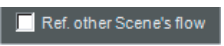

- Referring to Other Scene Flows (  )  
Units in other scenes can be referred to and added to the current scene flow.
- Selecting a scene to refer to displays the flow for that scene.



- Switching processing unit measurement execution ON/OFF (  )  
You can switch off the processing unit within a scene so that measurement is not executed for individual processing units. The processing unit that has been switched off cannot execute measurement until switched on. Clicking the button toggles the measurement execution setting between ON and OFF.



### Important

Make sure to enable Measure for the image input processing unit for unit 0 before use.



### Additional Information

- If a processing unit is inserted, the numbers for the subsequent processing units increase by one. With processing items related to results output or branch control, the numbers for processing units set as references also automatically increase by one.
- If a button other than [Paste] is clicked after pasting a processing unit, continued pasting of the processing item cannot be performed.
- If a processing unit is deleted, the numbers for the subsequent processing units decrease by one. With processing items related to results output or branch control, the numbers for processing units set as references also automatically decrease by one.
- To hide a specific processing unit in the flow on an adjustment window or run window, insert a "\*" (single byte) at the beginning of the processing unit name.
- With the FZ-L series and FZ-600 series, the number of units that can be set in a flow depends on the available data memory.  
With the FH series or FZ5-800/1100/1200 series, a warning message is displayed when the amount of available application memory falls below 1 GB. Adjust the inspection flow so that the available memory is more than 1 GB.  
Refer to 3-4 *Checking the Memory Consumption and Percentage of Memory Used* on page 3-31 and 3-3 *Checking System Information* on page 3-27.
- When copying and pasting a conditional branch processing unit or other processing unit that refers to another processing units, the branch destination of the pasted processing unit is initialized to [End processing]. When pasting whole processing units within a folder, a parallelization processing unit, or a parallelized task processing unit, references from inside the pasted block to outside the block are initialized to [End processing].  
When copying and pasting a calculation processing unit or other processing unit that refers to another processing unit, the content of the expression of the pasted processing unit becomes #ERR. When pasting whole processing units within a folder, a parallelization processing unit, or a parallelized task processing unit, references from inside the pasted block to outside the block become #ERR.
- Turning measurement execution ON/OFF for a folder, a parallelization processing unit or a parallelized task processing unit turns measurement execution ON/OFF for all processing units within the folder, the parallelization processing unit or the parallelized task processing unit.
- When [ON] is set for [Parallel Execute] in [Operation mode setting] in the system settings, turning the measurement execution setting ON/OFF for a processing unit may greatly change the processing time. In this case, use parallelization processing items to parallelize the measurement flow instead of using automatic parallel processing.  
For details, refer to 4-4-2 *Parallel Processing* on page 4-29.
- When measurement execution has been set to OFF for a processing unit that is a conditional branch destination, processing is executed starting with the first processing unit set to ON after the branch destination processing unit.
- When you set \*(half-width asterisk) to the front of processing unit name, its processing unit is not displayed on the Flow window.
- Overall judgement result of the processing units that are set in the folder is displayed in the folder unit. However, if a Conditional branch is set to branch outside the folder, the folder unit will display as OK.

## 5-4 Displaying and Checking Processing Branches in a Scene

To see how a branch affects the processing flow after you edit a scene in the edit flow window, start the Flow Viewer.

Select [Flow Viewer] from the [Tool] menu.

### Overview

The Flow Viewer shows the flow of processing for the measurement flow that is currently being edited.

This makes it easy to understand the relationship of branches and folders in the measurement flow.

The Flow Viewer allows you to edit the measurement flow, and also allows you to edit, rename, and save processing units in the same way as with the edit flow window.

You can save the flow of processing for the currently displayed measurement flow as an image file.

- You can also edit the measurement flow.
- You can edit the unit properties in the same way as with the edit flow window.
- You can save the flow of processing for the currently displayed measurement flow as an image in JPEG format.
- You can also rename and save processing units.

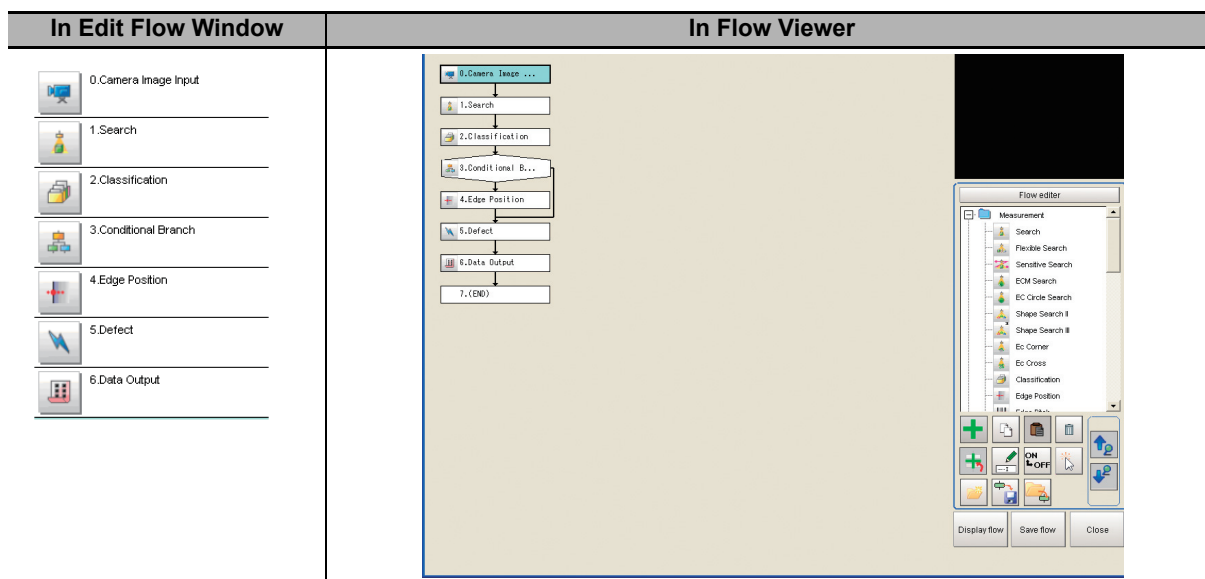



## Window Configuration

The window configuration for the Flow Viewer is shown below.

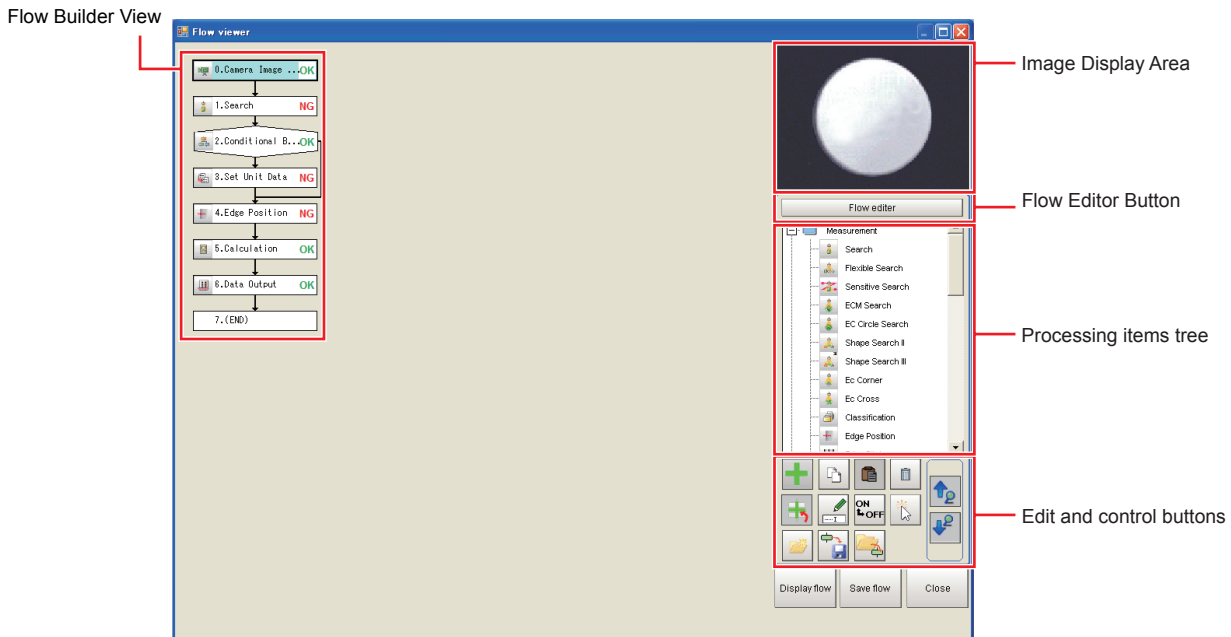

- **Image Display Area**

This area shows Camera images, figures, positions, and other graphic information. The measurement image is updated each time a unit is selected.

- **Flow Editor Button**

This button starts the edit flow window.

- **Tree of Processing Items**

This area allows you to select an item to add to the flow. The items are displayed in tree format that is organized by type.

## Flow Editing Functions

- **Repositioning a Unit within a Flow**

On the Flow Builder, drag the unit to the desired position.

To insert a unit before another unit, drag it onto the desired unit.

- **Right-click Menu**

The following popup menu is displayed when you right-click on a unit in the flow.

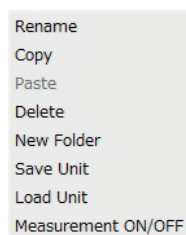

The menu commands perform the same operations as the Edit and Control Buttons.

● **Edit and Control Buttons**

Icon button	Function	Description
	Add to End of Flow	Adds the selected item in the item tree to the end of the flow as a new unit.
	Add before Current Unit	Adds the selected item in the item tree to the position directly before the selected unit in the flow as a new unit.
	New Folder	Creates a folder directly before the selected unit in the flow. Drag units to edit the contents of the folder.
	Copy	Copies the selected unit in the flow.
	Paste	Pastes the copied unit to the position directly before the selected unit in the flow.
	Delete	Deletes the selected unit from the flow.
	Rename	Renames the selected unit in the flow.
	Save Unit	Saves the settings for the selected unit in the flow to a file (with the extension .unt).

Icon button	Function	Description
	Load Unit	Loads the settings for a processing unit from a file (extension .unit) and places it directly before the selected unit in the flow.
	Measurement ON/OFF	Used to turn off measurement execution for individual in-scene processing units so that measurement is not executed.
	Movement mode	Enables the flow display position to be moved by drag operations instead of by using the scroll bar. Press the button again to exit Movement mode.
	Search Up	Searches for the selected item in the item tree upward from the selected position in the flow.
	Search Down	Searches for the selected item on the item tree in the downward direction from the selected position in the flow.
	Display Entire Flow	Displays the entire flow in the center of the view. The [Save] button outputs the same image as the [Save flow] button.
	Save Flow Image	Outputs the entire flow as an image file (extension .jpg).
	Exit Flow Viewer	Closes the Flow Viewer.

● **Changing the Properties of Units in a Flow**

On the Flow Builder, click the icon to the left of the unit for which to change the properties. The property dialog box for the unit is displayed.

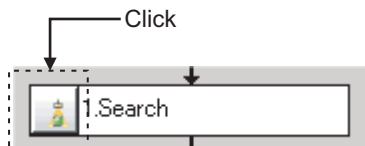

## Examples of Branch and Folder Views

Examples:

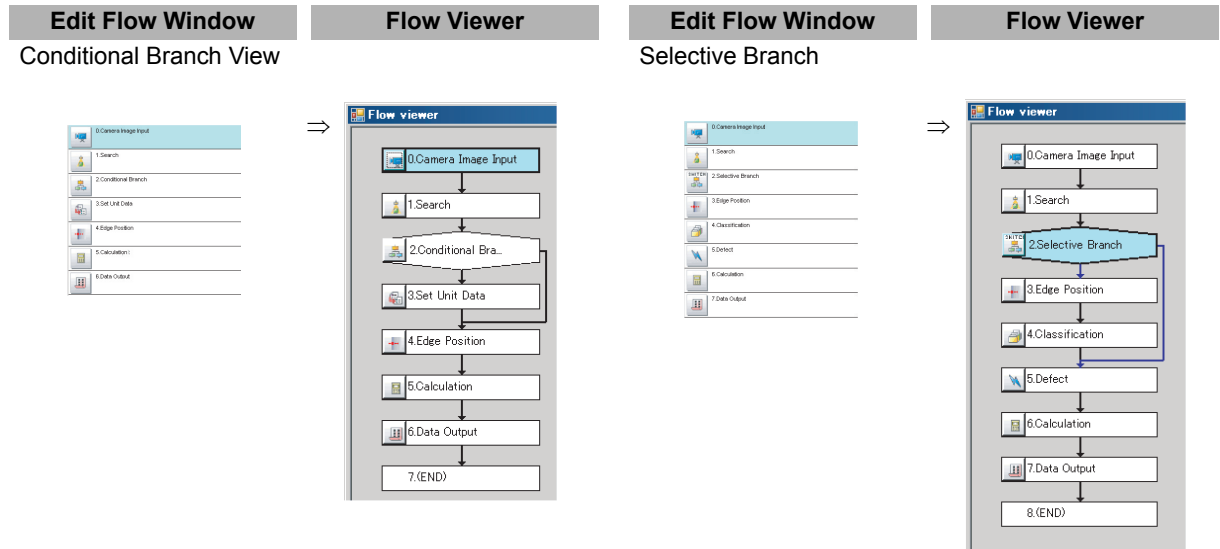

Folder View

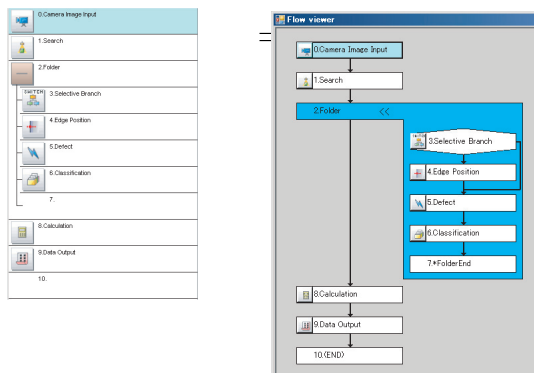

### Important

When displaying a hierarchical structure with Folder View, a flow with 11-hierarchy or more cannot be displayed by Flow Viewer.

## 5-5 Using Variables to Edit the Flow [TDM Editor]

Using this Editor, more advanced editing of a flow can be done.

Click [TDM Editor] on the [Tool] shortcut menu to open the Edit flow screen.

### 5-5-1 Edit Flow Screen

In this screen, you can create, define, reference, and assign variables to be used in Measurement flows and Scenes. You can also arrange, add, or delete processing units in a scene and perform test measurements.

Refer to 5-1 *What Is a Scene?* on page 5-2.

Refer to 7-1 *What Is a Scene Group?* on page 7-2.

#### ● Structure of the Edit Flow Screen

The Edit flow screen is composed of three tabs: Edit flow, Scene variable, and System variable.

Click a tab to switch among screens.

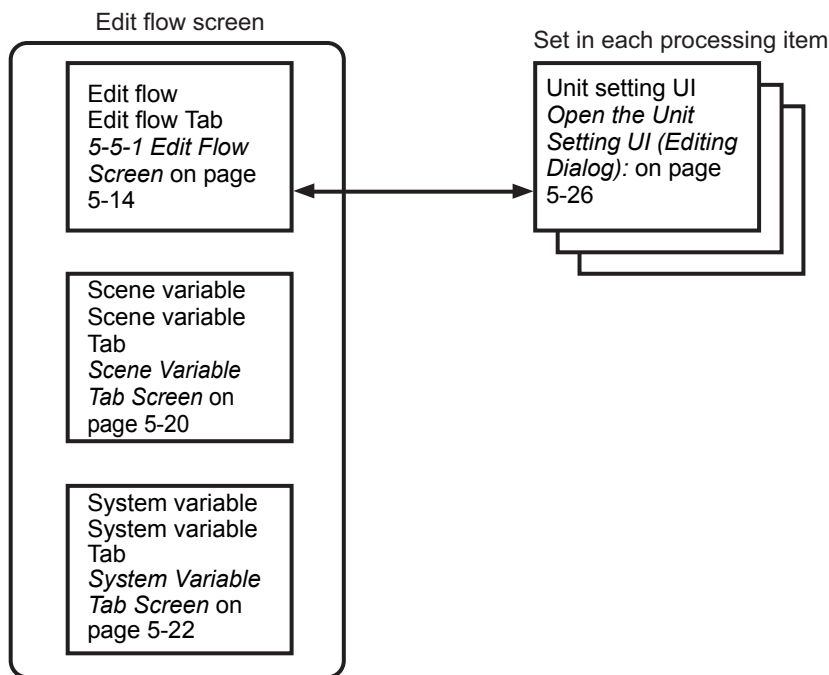

## Edit Flow Tab Screen

In this screen, you can add processing items to the flow, rearrange or delete the added processing units, change the settings, assign variables to parameters, and perform test measurements on the edited flow.

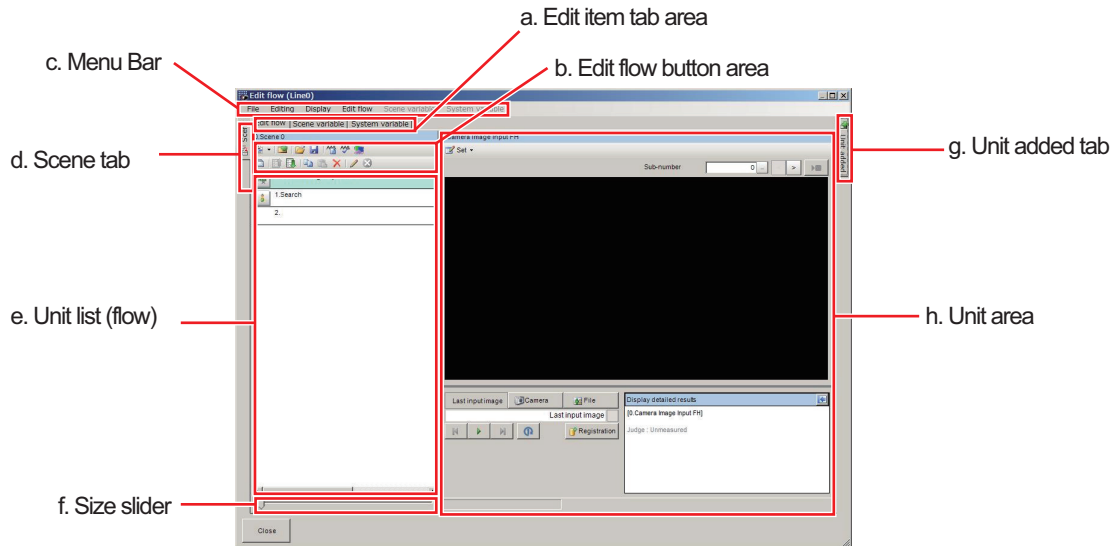

(a) Edit item tab area:

Clicking a tab switches screens among Edit flow, Scene variable, and System variable.









(b) Edit flow button area:

Rearrange or delete processing units in the scene.

The items are the same as the shortcut menu items of [Edit flow] in the Menu bar and the items displayed when the right mouse button is clicked on the unit list (flow).

For more details, refer to 5-5-2 *Editing Processing Units in a Scene* on page 5-24.

Icon/Button	Function	Description
	Menu	Displays items of [Edit flow] in the Menu bar with a shortcut menu format.
	New Folder	Creates a folder at the position selected on the Unit list (Flow).
	Load Unit	Inserts a loaded processing unit at the position selected on the unit list (Flow). The selection of the unit to be loaded is performed with the displayed FileExplorer.
	Save Unit	Saves a processing unit at the position selected on the Unit list (Flow). The setting for Save Destination and Name is performed with the displayed FileExplorer.
	Variable assignment list	Displays the "Variable assignment list" dialog.
	Variable check	Checks whether undefined variables are assigned. If there were undefined variables, a warning dialog will be displayed.
	Shift area	Performs batch conversion for the related figure data. The settings are made in the Shift area dialog. Refer to 6-5-5 <i>Changing Regions as a Batch [Shift area]</i> on page 6-37.

Icon/Button	Function	Description
	Multiple selection	Uses when copying or deleting processing units at once. If you click [Multiple selection], a check box will be added to the right of each processing unit in the Unit list (Flow). The operation will be applied to the checked units.
	Move up	Moves the selected processing unit UP one position on the Unit list (Flow).
	Move down	Moves the selected processing unit DOWN one position on the Unit list (Flow).
	Copy	Copies a processing unit selected on the Unit list (Flow), while holding the settings data and the variables being used.
	Paste	Inserts the copied processing unit to the position selected on the Unit list (Flow).
	Delete	Deletes a processing unit selected on the Unit list (Flow).
	Rename	Renames a processing unit name selected on the Unit list (Flow). The name change is made in the displayed [Rename] dialog.
	Measure ON/OFF	Enables or disables the measurement execution for a selected processing unit on the Unit list (Flow). Clicking "Measure ON/OFF" toggles between enabling and disabling the measurement execution. When disabling the measurement execution, an "X" mark is displayed on the property setting button of each processing unit on the Unit list (flow).

(c) Menu bar:

This is a list of functions provided in the Edit flow tab screen.

Clicking the menu item displays available functions with a shortcut menu.

- File:

Icon/Button	Function	Description
	Close	Closes the screen and exits the TDM editor.

- Editing:

Icon/Button	Function	Description
	Registered image	Opens the "Registered image" dialog to manage the Registered images. You can save images used for model registration and reference registration as registration images and can reference them later and use them for re-registration and adjustment of reference positions. Refer to <i>6-7 Managing Images used for Model Registration and Reference [Registered Image Manager]</i> on page 6-42.

- Display:

Icon/Button	Function	Description
	Large buttons	Enlarges the size of the icons/buttons displayed on the Edit flow button area.

- Edit flow:  
This is available only when the [Edit flow] tab is selected in the Item tab area.  
The items displayed when clicking this are same as buttons in the Edit flow button area except for the [Menu] item.
- Scene variable:  
This is available only when the [Scene variable] tab is selected in the Item tab area.
- System variable:  
This is available only when the [System variable] tab is selected in the Item tab area.

(d) Scene tab:

Possible to switch, copy/paste, and delete scenes.

For more details, refer to 5-5-3 *Editing Scenes* on page 5-34.

(e) Unit list (flow):

A list of processing units composing the flow is displayed.

A measurement flow for a scene can be created by adding processing items to the Unit list (flow) from the Unit added tab.

(f) Size slider:

Dragging the slider to the right makes the unit list bigger and to the left makes it smaller.

(g) Unit added tab:

Clicking it displays the processing items with a list. A selected processing item from the list can be added to a measurement flow.

For more details, refer to *Adding Processing Units to a Scene* on page 5-25.

(h) Unit area:





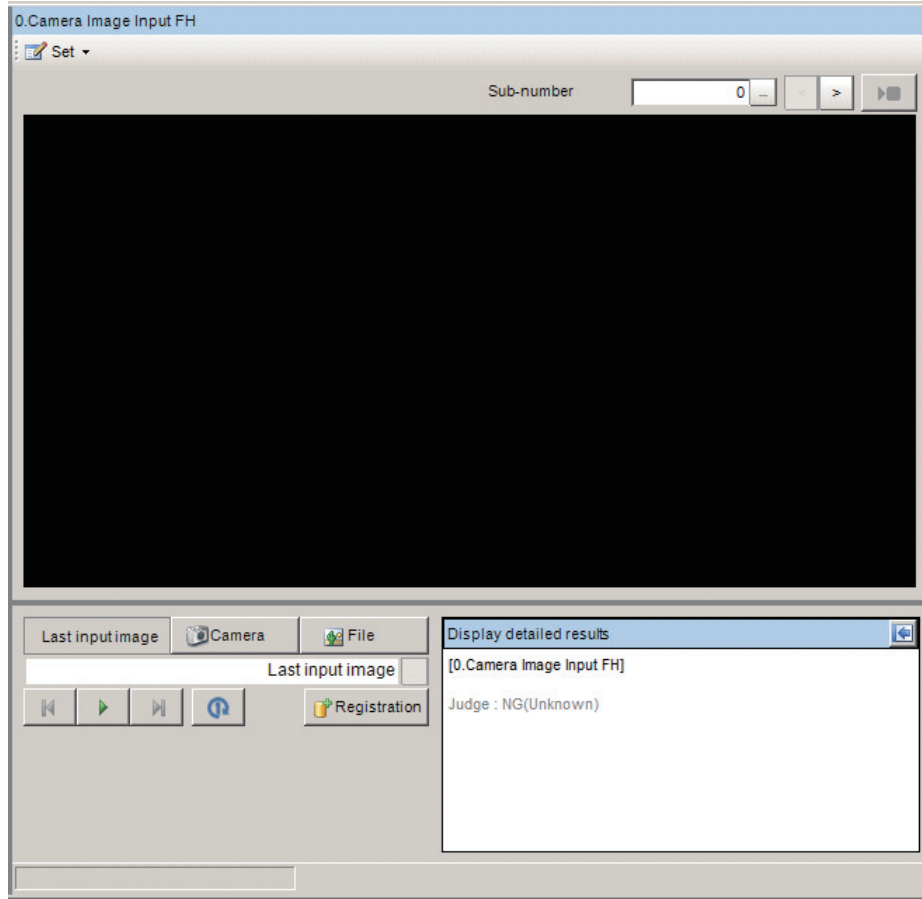







This area provides a setting function and test measurement function for a processing unit selected on the Unit list (flow).

The image window for a processing unit selected on the Unit list (flow) is displayed.



Item	Content
Set button	<p>Opens the settings menu of the processing item.</p> <ol style="list-style-type: none"> <li>1. Open the unit setting UI: Displays the “Editing” dialog box*1.</li> <li>2. Open the unit setting old UI: Displays the legacy processing item setting screen.</li> </ol>
Sub number	Specifies a sub image number for the measurement image to display.
Last input image	<p>Performs a test measurement on the last input image.</p> <p>▶▶ : Not used.</p> <p>⋮ : Not used.</p> <p>⏪ : Not used.</p> <p>▶ : Performs a test measurement. The results will be displayed on the image, detailed results display area, and the Unit list (flow).</p> <p>⏩ : Not used.</p> <p>🔄 : Performs a unit measurement. The results will be displayed on the image and the detailed results display area.</p>



Item	Content
Camera	<p>Performs a test measurement with the camera image.</p> <p> : Changes the camera image mode to Through image.</p> <p> : Not used.</p> <p> : Not used.</p> <p> : Performs a test measurement. The results will be displayed on the image, detailed results display area, and the Unit list (flow).</p> <p> : Not used.</p> <p> : Performs a unit measurement. The results will be displayed on the image and the detailed results display area.</p>
Files	<p>Performs a test measurement on with an image file.</p> <p> : Not used.</p> <p> : Selects an image file and a reference image for the test measurement.</p> <p> : Not used.</p> <p> : Performs a test measurement. The results will be displayed on the image, detailed results display area, and the Unit list (flow).</p> <p> : Not used.</p> <p> : Performs a unit measurement. The results will be displayed on the image and the detailed results display area.</p>
Registration	Registers the displayed image as a reference image.
Display detailed results	Displays the name and the measurement results of a processing unit selected on the Unit list (flow).

\*1. Regarding [Open the unit setting UI], refer to *Setting Properties for Processing Units* on page 5-26 of 5-5-2 *Editing Processing Units in a Scene* on page 5-24.



#### Additional Information

- In the flow measurement, a measurement is performed with the set flow.  
In the unit measurement, a measurement is performed only with the processing unit selected.
- The unit measurement cannot be performed with processing items categorized in image input related (Input Image).



#### Additional Information

When the measurement of a processing unit is performed, the overall judgement and the processing time are displayed up to 8,191-unit under each processing unit name on the Unit list (flow). When the measurement is performed over 8,291-unit, i.e. with a repeat processing, the overall judgement and the processing time will not be displayed from 8,192-unit and later.

## Scene Variable Tab Screen

A Scene variable holds data such as parameters and measurement results for a processing item, moreover, which is also used to reference data and/or perform calculations between processing units in a scene.

In the Scene variable tab screen, scene variables can be registered, deleted, referenced, and changed. Assigning scene variables is performed by clicking [Open the unit setting UI] on the shortcut menu of [Set] button on the Edit flow tab screen.

For details, refer to *5-5-4 Using Variables* on page 5-43.

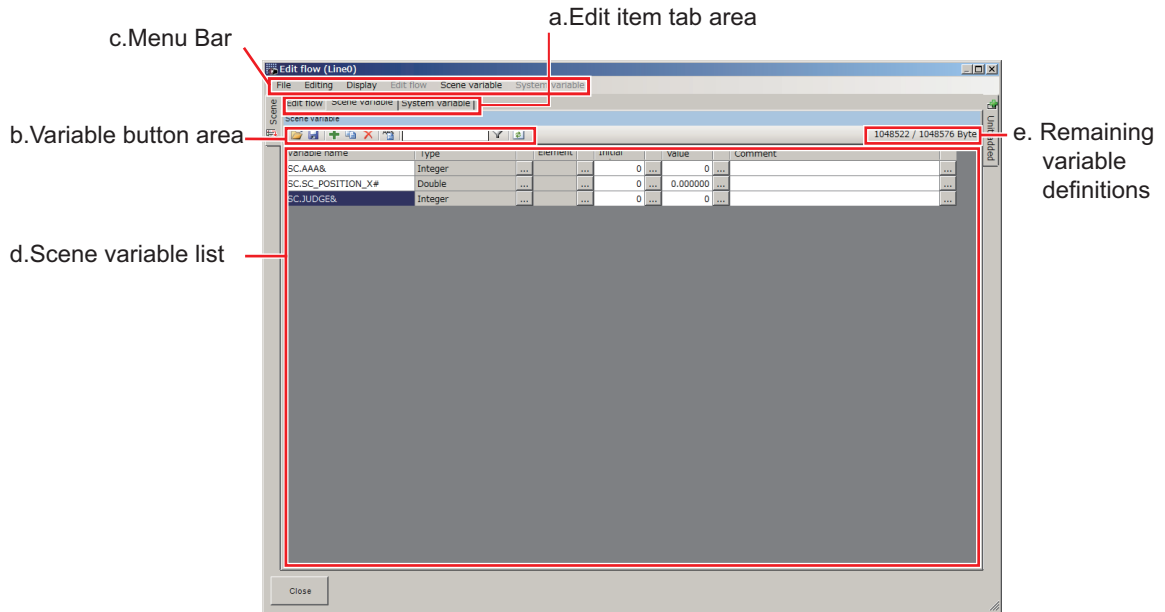





(a) Edit item tab area:



Clicking a tab switches tab screens among Edit flow, Scene variable, and System variable.

(b) Variable button area:

These are used to adding, copying, or deleting scene variables.

The items are the same as the shortcut menu items of [Scene variable] in the Menu bar and the items displayed when the right mouse button is clicked at each variable name on the Scene variable list expect for the “Filter display” item.

Icon/Button	Function	Description
	Open	Loads a list of variables from a CSV file. The variables defined before loading will be deleted. The selection for a CSV file to be loaded is performed with the displayed FileExplorer.
	Save	Saves a list of variables to a CSV file. The setting for Save Destination and Name is performed with the displayed FileExplorer.
	Add	Adds a variable. The setting for the variable’s name and type to be added is performed with the “Add” dialog box displayed.
	Copy	Copies a variable selected on the list, while holding data except the name. The setting for the variable name to be copied is performed with the “Copy” dialog box displayed.
	Delete	Deletes a variable selected on the list.

Icon/Button	Function	Description
	Variable assignment list	Displays the "Variable assignment list" dialog.
	Filter display	Displays a display filter currently set. The background color will become light blue when a display filter has been set.
	Filter	Sets a display filter for the Scene variable list. The setting for the filter is performed with the "Filter setting" dialog displayed.

## (c) Menu bar:

This is a list of functions provided in the [Scene variable] tab in the Edit flow screen. Clicking the menu item displays available functions with a shortcut menu.

## • File:

Icon/Button	Function	Description
	Close	Closes the screen and exits the TDM editor.

## • Editing:

Icon/Button	Function	Description
	Registered image	Opens the "Registered image" dialog to manage the registered images. You can save images used for model registration and reference registration as registration images and can reference them later and use them for re-registration and adjustment of reference positions. Refer to 6-7 <i>Managing Images used for Model Registration and Reference [Registered Image Manager]</i> on page 6-42.

## • Display:

Icon/Button	Function	Description
	Large buttons	Enlarges the size of the icons/buttons displayed on the Edit flow button area.

## • Edit flow:

This is available only when the [Edit flow] tab is selected in the Item tab area.

## • Scene variable:

This is available only when the [Scene variable] tab is selected in the Item tab area.

The items displayed when clicking this are same as buttons in the Variable button area except for the "Filter display" item.

## • System variable:

This is available only when the [System variable] tab is selected in the Item tab area.

- (d) Scene variable list:  
Display a list of Scene variables being used. The values of the Scene variables can be edited.
- (e) Remaining variable definitions:  
Display the remaining available (bytes) to be used for the variable definition.

## System Variable Tab Screen

A System variable holds data such as parameters and measurement results for a processing item, moreover, which is also used to reference data and perform calculations between units across different scenes and scene groups.

In the System variable tab screen, system variables can be registered, deleted, referenced, and changed. Assigning system variables is performed by clicking [Open the unit setting UI] on the shortcut menu of [Set] button on the Edit flow tab screen.

For details, refer to *5-5-4 Using Variables* on page 5-43.

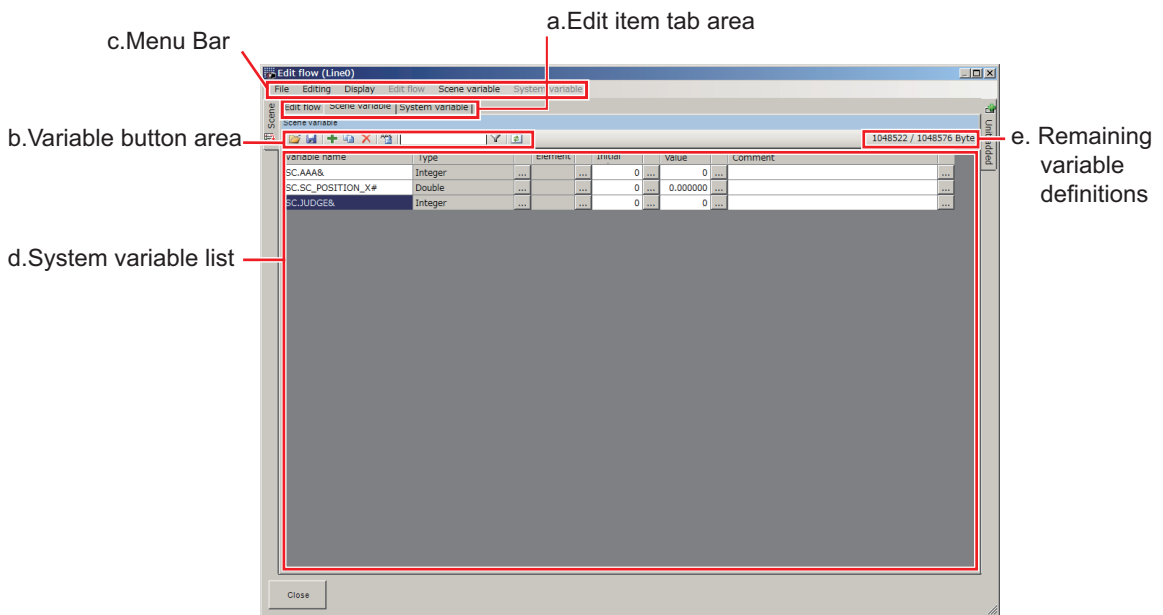









- (a) Edit item tab area:  
Clicking a tab switches tab screens among Edit flow, Scene variable, and System variable.

## (b) Variable button area:

These are used to adding, copying, or deleting system variables.

The items are the same as the shortcut menu items of [System variable] in the Menu bar and the items displayed when the right mouse button is clicked at each variable name on the System variable list expect for the "Filter display" item.

Icon/Button	Function	Description
	Open	Loads a list of variables from a CSV file. The variables defined before loading will be deleted. The selection for a CSV file to be loaded is performed with the displayed FileExplorer.
	Save	Saves a list of variables to a CSV file. The setting for Save Destination and Name is performed with the displayed FileExplorer.
	Add	Adds a variable. The setting for the variable's name and type to be added is performed with the "Add" dialog box displayed.
	Copy	Copies a variable selected on the list, while holding data except the name. The setting for the variable name to be copied is performed with the "Copy" dialog box displayed.
	Delete	Deletes a variable selected on the list.
	Variable assignment list	Displays the "Variable assignment list" dialog.
	Filter display	Displays a display filter currently set. The background color will become light blue when a display filter has been set.
	Filter	Sets a display filter for the variable list. The setting for the filter is performed with the "Filter setting" dialog displayed.

## (c) Menu bar:

This is a list of functions provided in the [System variable] tab in the Edit flow screen.

Clicking the menu item displays available functions with a shortcut menu.

- File:

Icon/Button	Function	Description
	Close	Closes the screen and exits the TDM editor.

- Editing:

Icon/Button	Function	Description
	Registered image	Opens the “Registered image” dialog to manage the registered images. You can save images used for model registration and reference registration as registration images and can reference them later and use them for re-registration and adjustment of reference positions. Refer to <i>6-7 Managing Images used for Model Registration and Reference [Registered Image Manager]</i> on page 6-42.

- Display:

Icon/Button	Function	Description
	Large buttons	Enlarges the size of the icons/buttons displayed on the Edit flow button area.

- Edit flow:

This is available only when the [Edit flow] tab is selected in the Item tab area.

- Scene variable:

This is available only when the [Scene variable] tab is selected in the Item tab area.

- System variable:

This is available only when the [System variable] tab is selected in the Item tab area. The items displayed when clicking this are same as buttons in the Variable button area except for the “Filter display” item.

- (d) System variable list:

Display a list of System variables being used. The values of the System variables can be edited.

- (e) Remaining available definitions:

Display the remaining available (bytes) to be used for the variable definition.

## 5-5-2 Editing Processing Units in a Scene

### Opening Edit flow

- 1 In the main screen, click [TDM Editor] on the [Tool] shortcut menu.  
The Edit flow tab screen is displayed.
- 2 Edit scenes and create a flow on the Edit flow tab screen displayed.

### Closing Edit flow

- 1 Click [Close] at the bottom left of the screen.  
Exit the TDM editor and return to the main screen, while holding the set contents.



#### Additional Information

The following operation also makes the TDM editor exit and return to the main screen, while holding the set contents.

- Click [Close] from [File] in the Menu bar.
- Click [Close] at the right side of the title bar.

## Adding Processing Units to a Scene

- 1 Display the Edit flow tab screen for the scene to edit.  
For more details, refer to *5-5-1 Edit Flow Screen* on page 5-14.
- 2 Click the [Unit added] tab.  
On the Unit added tab, the processing items are displayed with a tree style per type. Clicking “+” at the head of each item displays the lower level items. Clicking “-” at the head of each item closes the lower level items being displayed.

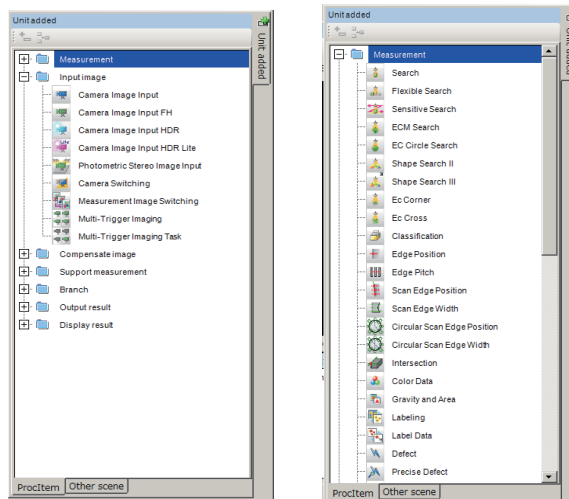
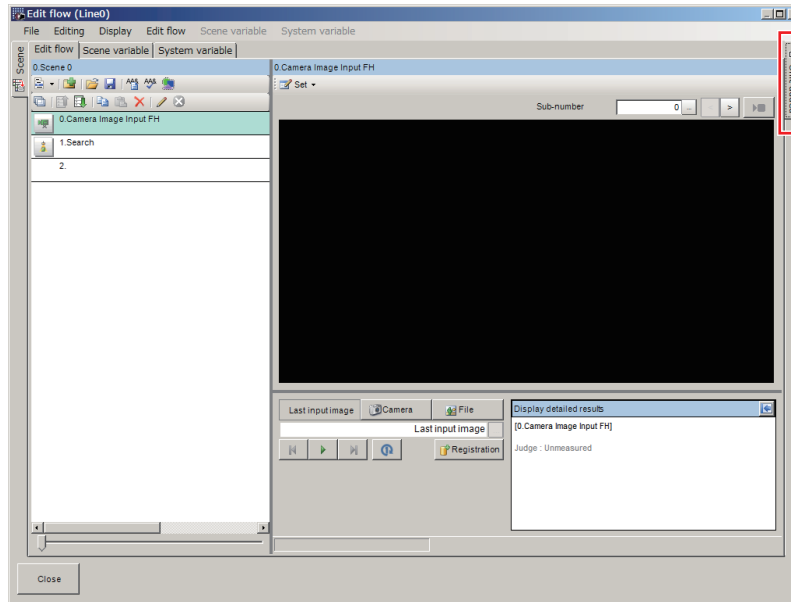

- 3 Select a processing item to add from the list of processing items on the Unit added tab.
- 4 Click [Append] icon or [Insert] icon at the upper side of the Unit added tab.  
The selected processing item is added to the bottom (Append) or the specified position (Insert) on the Unit list (flow).

Icon/Button	Function	Description
	Append	Adds a processing item selected on the processing item list to the bottom of the Unit list (flow).

Icon/Button	Function	Description
	Insert	Inserts a processing item selected on the processing item list to the specified position on the Unit list (flow).



#### Additional Information

The following operation also enables processing items to be added to the Unit list (flow).

- Drag a processing item selected on the processing item list and drop it on the Unit list (flow).
- Right-click a processing item selected on the processing item list and click [Append] or [Insert].

- 5 Repeat the step 3 to 4 to add more processing items.



#### Additional Information

The number of image input processing items are limited.

For more details, refer to *A-13 About Limits on the Number of Image Input Processing Items Used* on page A-39.

## Setting Properties for Processing Units

- 1 Display the Edit flow screen for the scene to edit.  
For more details, refer to *5-5-1 Edit Flow Screen* on page 5-14.
- 2 On the Unit list (flow), select a processing unit to set properties.  
The selected processing unit name is displayed on the Unit area.
- 3 Click [Set] on the Unit area and click [Open the unit setting UI] or [Open the unit setting old UI].  
In the case of [Open the unit setting UI], the “Editing” dialog box is displayed. In the case of [Open the unit setting old UI], the usual property setting screen is displayed.
- 4 Set the conditions on the “Editing” dialog.  
The displayed contents depend on a processing item.

### ● Open the Unit Setting UI (Editing Dialog):

Sets conditions such as measurement parameters and judgment conditions for processing items as processing units registered on the measurement flow. A test measurement can be performed on the unit area of the Edit flow tab screen even with a state that this window is opened.

Furthermore, variables can be assigned to parameters. In order to assign variables to parameters, check the check box of the “Variable assignment” at the lower-left.



Input parameter tab:

Display a list of input parameters for a processing unit selected on the Unit list (flow).

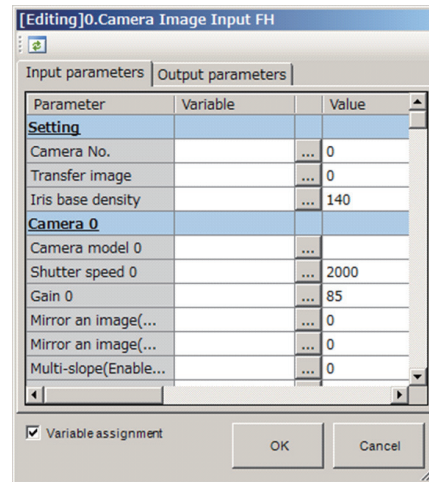
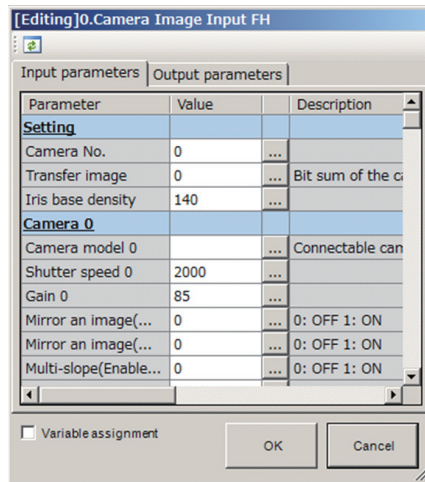

Output parameter tab:

Displays a list of Output parameters for the processing unit selected in the flow.

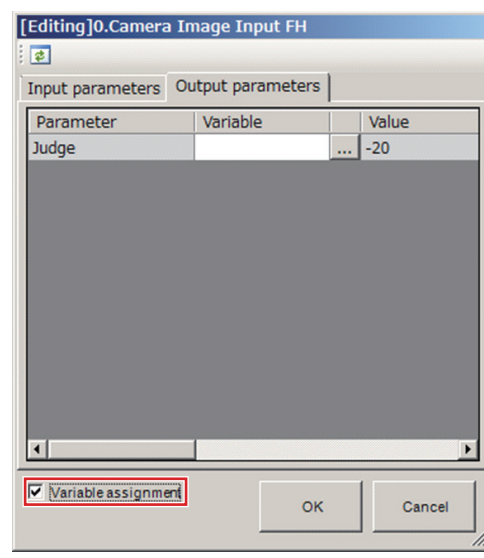
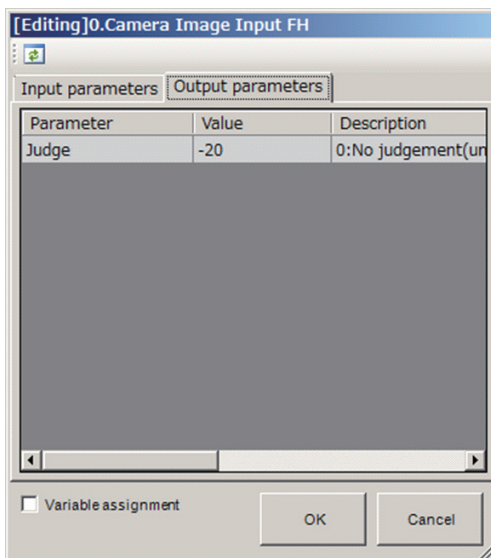



For more details, refer to *Vision System FH/FHV/FZ5 Series Processing Item Function Reference Manual (Z341)*.

**5** After completing the condition settings, click [OK].

Return to the Edit flow tab screen while holding the set contents. When clicking [Cancel], then dispose of the set contents and return to the Edit flow tab screen.

## Moving a Processing Unit

- 1** Display the Edit flow tab screen for the scene to edit.  
For more details, refer to *5-5-1 Edit Flow Screen* on page 5-14.
- 2** On the Edit flow tab screen, select a processing unit on the Unit list (flow) to move.
- 3** In the Edit flow button area, click  [Move up].  
The selected processing unit will move one position up from the current position.  
When clicking  [Move down], the selected one will move one position down from the current position.



### Additional Information

The following operation also enables processing units to move.

- Click [Move up] or [Move down] from [Edit flow] in the Menu bar.
- Drag a processing unit on the Unit list (flow) and drop it on the specified position on the Unit list (flow).
- Right-click a processing unit on the Unit list (flow) and then click [Move up] or [Move down] on the displayed shortcut menu.



### Additional Information

When attempting to move a processing unit to the processing unit number 0, a warning dialog will be displayed.

## Copying/Pasting a Processing Unit

- 1** Display the Edit flow tab screen for the scene to edit.  
For more details, refer to *5-5-1 Edit Flow Screen* on page 5-14.
- 2** On the Edit flow tab screen, select a processing unit on the Unit list (flow) to copy.
- 3** In the Edit flow button area, click  [Copy].  
Copy the selected processing item while holding data and variables being used.



### Additional Information

The following operation also enables processing units to be copied.

- Click [Copy] from [Edit flow] in the Menu bar.
- Right-click a processing unit on the Unit list (flow) and then click [Copy] on the displayed shortcut menu.

- 4** On the unit list (flow), select a position to paste.
- 5** In the Edit flow button area, click  [Paste].  
The copied processing unit is inserted to the selected position on the Unit list (flow) while holding the setting data and variables being used.

**Additional Information**

The following operation also enables processing units to be pasted.

- Click [Paste] from [Edit flow] in the Menu bar.
- Right-click a processing unit on the Unit list (flow) and then click [Paste] on the displayed shortcut menu.

**Additional Information**

When attempting to paste a processing unit to the processing unit number 0, a warning dialog will be displayed.

**Deleting a Processing Unit**

- 1** Display the Edit flow tab screen for the scene to edit.  
For more details, refer to *5-5-1 Edit Flow Screen* on page 5-14.
- 2** On the Edit flow tab screen, select a processing unit on the Unit list (flow) to delete.
- 3** In the Edit flow button area, click  [Delete].

**Additional Information**

The following operation also enables processing units to be deleted.

- Click [Delete] from [Edit flow] in the Menu bar.
- Right-click a processing unit on the Unit list (flow) and then click [Delete] on the displayed shortcut menu.

- 4** The "Edit flow" dialog is displayed. Click [Yes].  
The selected processing item is deleted.

**Additional Information**

When attempting to delete a processing unit number 0, a warning dialog will be displayed.

**Saving/Loading a Processing Unit**

The added or edited processing units can be saved or loaded.

- **Saving a Processing Unit**

- 1** Display the Edit flow tab screen for the scene to edit.  
For more details, refer to *5-5-1 Edit Flow Screen* on page 5-14.
- 2** On the Edit flow tab screen, select a processing unit on the Unit list (flow) to save.

- 3** In the Edit flow button area, click  [Save Unit].

The FileExplorer dialog box is displayed.

For more details, refer to 3-2-3 *Selecting Files and Folders* on page 3-10.

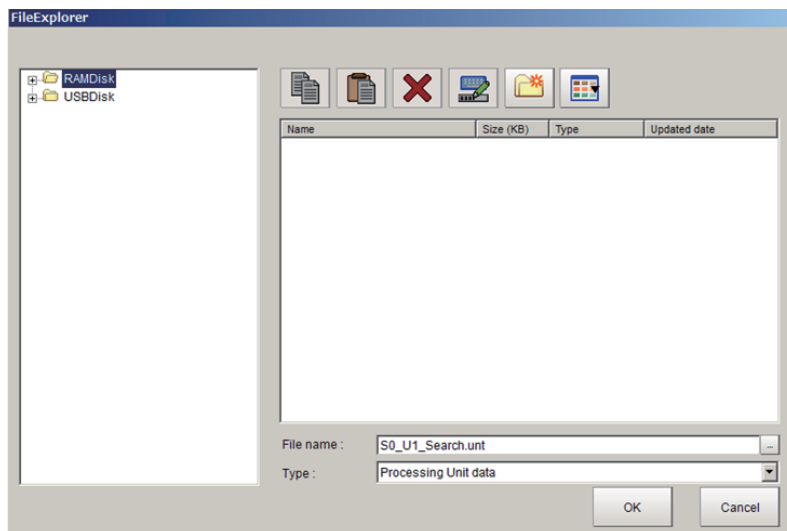

#### Additional Information

The following operation also enables processing units to save.

- Click [Save Unit] from [Edit flow] in the Menu bar.
- Right-click a processing unit on the Unit list (flow) and then click [Save Unit] on the displayed shortcut menu.

- 4** Set the save destination folder and file name, and then click [OK].

The processing unit is saved while holding the setting data and variables being used for it.

### ● Loading a Processing Unit

- 1** On the Unit list (flow), select a processing unit to be load.

- 2** In the Edit flow button area, click  [Load Unit].

The FileExplorer is displayed.

For more details, refer to 3-2-3 *Selecting Files and Folders* on page 3-10.



#### Additional Information

The following operation also enables processing units to be loaded.

- Click [Load Unit] from [Edit flow] in the Menu bar.
- Right-click a processing unit on the Unit list (flow) and then click [Load Unit] on the displayed shortcut menu.

- 3** Set the load destination and file name to be loaded.

The loaded processing unit is inserted to the selected position on the Unit list (flow).





#### Additional Information

When attempting to load a processing unit to the processing unit number 0, a warning dialog will be displayed.

## Switching Processing Unit Measurement ON/OFF

The measurement function can be enabled and disabled per processing unit. A processing unit that the function has been disabled cannot perform the measurement until the function is enabled.

- 1 Display the Edit flow tab screen for the scene to edit.  
For more details, refer to *5-5-1 Edit Flow Screen* on page 5-14.
- 2 On the Edit flow tab screen, select a processing unit on the Unit list (flow) that its measurement function is to be enabled or disabled.
- 3 In the Edit flow button area, click  [Measurement ON/OFF].

An “X” is marked on the selected processing unit icon. That means that the measurement function of it is disabled. Clicking  toggles the ON/OFF state of the measurement function.

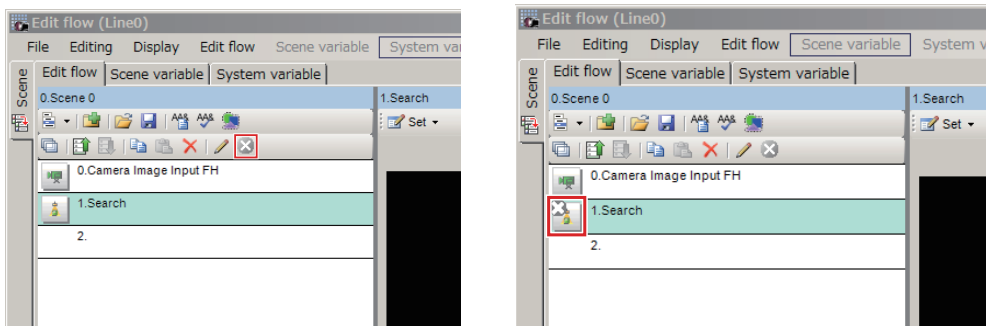

### Important

Be sure to enable the measurement function for the image input processing unit with the unit No. 0 before use.



### Additional Information

The following operation also enables or disables the measurement function for a processing unit.

- Click [Measurement ON/OFF] from [Edit flow] in the Menu bar.
- Right-click a processing unit on the Unit list (flow) and then click [Measurement ON/OFF] on the displayed shortcut menu.



### Additional Information

- Turning on or turning off the measurement function for a folder, a parallelization processing unit, or a parallelized task processing unit turns on or off the measurement for all processing units for the folder, the parallelization processing unit, or the parallelized task processing unit.
- When [ON] is set for [Parallel Execute] in [Operation mode setting] in the system settings, turning the measurement function setting ON/OFF for a processing unit may greatly change the processing time. In this case, use parallelization processing items to parallelize the measurement flow instead of using automatic parallel processing. For details, refer to *4-4-2 Parallel Processing* on page 4-29.
- When the measurement function for a processing unit in a conditional branch destination has been disabled, the measurement will be performed from a processing unit set to on in the following branch destination processing units.
- Overall judgement result of the processing units that are set in the folder is displayed in the folder unit. However, if a Conditional branch is set to branch outside the folder, the overall judgement result of the processing units set in the folder unit will always display as OK.

## Handling Multiple Processing Units at once

This function is used when copying or deleting multiple processing units together.

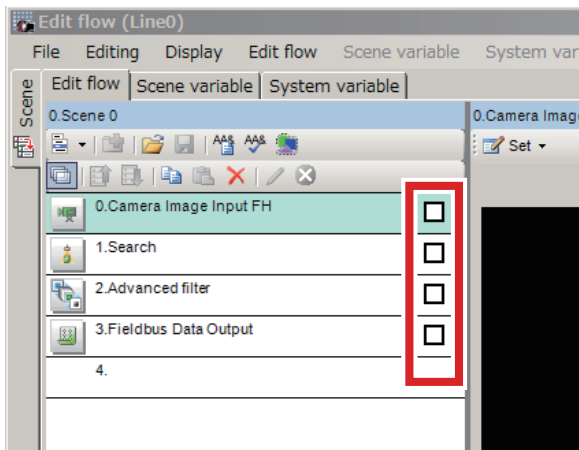

- 1 Display the Edit flow tab screen for the scene to edit.  
For more details, refer to *5-5-1 Edit Flow Screen* on page 5-14.
- 2 On the Edit flow tab screen, click  [Multiple selection] in the Edit flow button area.  
A check box is displayed at the right of each processing unit on the Unit list (flow).



### Additional Information

The following operation also enables the [Multiple selection].

- Click [Multiple selection] from [Edit flow] in the Menu bar.
- Right-click a processing unit on the Unit list (flow) and then click [Multiple selection] on the displayed shortcut menu.

- 3 Check a checkbox displayed at the right side of each processing unit on the Unit list (flow) to select the units to be included in the Multiple selection.
- 4 Click  [Copy] or  [Delete].

For more details, refer to *Copying/Pasting a Processing Unit* on page 5-28 and *Deleting a Processing Unit* on page 5-29.



### Additional Information

The check is cleared when the units are either copied or deleted.

## Referencing another Scene's Flow

This is used to edit a flow by referring to another flow in a different scene.

- 1** Display the Edit flow tab screen for a target scene to edit.  
For more details, refer to *5-5-1 Edit Flow Screen* on page 5-14.
- 2** Click [Unit added] tab.  
The Unit added tab is displayed.
- 3** Click [Other scene] at the lower-left on the Unit added tab.

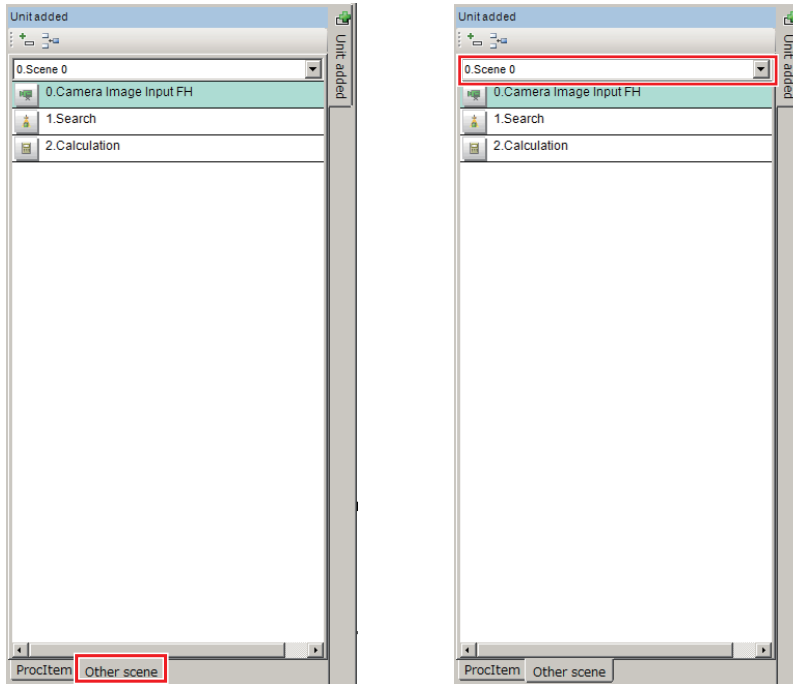

- 4** Select a scene including a unit to reference.  
The flow of the selected scene is displayed under the scene number.
- 5** Select a processing unit to add from the displayed flow.
- 6** Click [Append] icon or [Insert] icon at the upper side of the Unit added tab.  
The selected processing item is added to the bottom (Append) or the specified position (Insert) on the Unit list (flow).



### Additional Information

The following operation also enables processing items to be added to the Unit list (flow).

- Drag a processing unit selected on the processing item list and drop it on the Unit list (flow).
- Right-click a processing unit selected on the processing item list and click [Append] or [Insert]. When clicking [Insert], first select a position on the Unit list (flow) where the selected processing unit will be inserted.



### Important

When a processing unit is added from another scene, the system variables and parameters being used in the original scene are also added. Since the scene variables being used in the original scene cannot be referenced across scenes, the definition and values cannot be copied. The scene variable name used in the original scene is however displayed in the variable area for the input parameter area and output parameter area on the Edit flow tab screen. Therefore, check such undefined scene variables using the "Variable assignment list" window. Undefined scene variables are displayed in red. Re-define or delete them.

### 5-5-3 Editing Scenes

Here explains how to switch, copy, and delete scenes, or change the name of scenes.



#### Additional Information

Scene groups cannot be edited. For scene groups, perform it in the main screen.

For more details, refer to *7 Increasing/Switching Measurement Scenes* on page 7-1.

## Switching Scenes

- 1 Select [Scene] tab on the Edit flow screen.

A list of scenes is displayed. The current scene has a check mark.

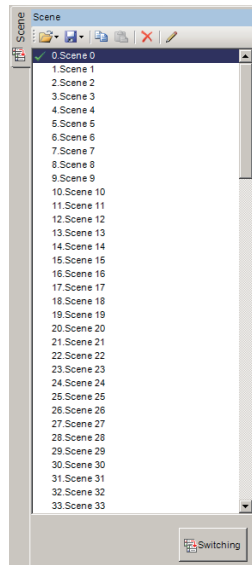

- 2 Select a scene on the scene list to switch, click [Switching] at the bottom of the list or double click the selected scene.

A "Confirmation" dialog will be displayed.

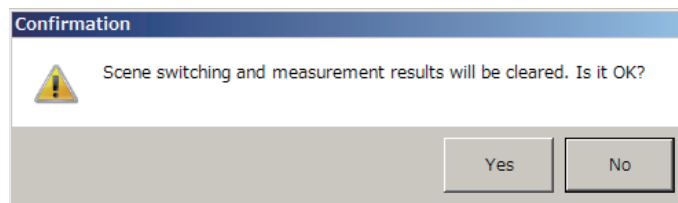

- 3 Click [Yes].

The current scene is switched to the selected scene.



## Loading a scene

- 1 Select the Scene tab on the Edit flow screen.  
A list of scenes is displayed. The current scene has a check mark.
- 2 Select a scene on the scene list to load and click  [Open].

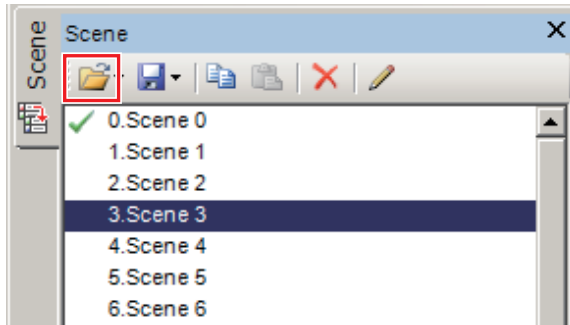

- 3 Select whether to load the scene data or the scene data and the registered image together.

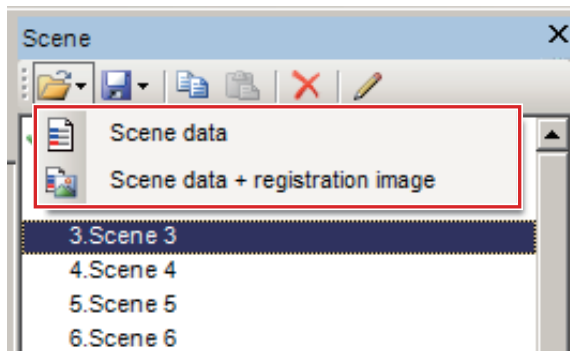

### ● Loading a scene data

- 1 Click [Scene data].  
FileExplorer is displayed.

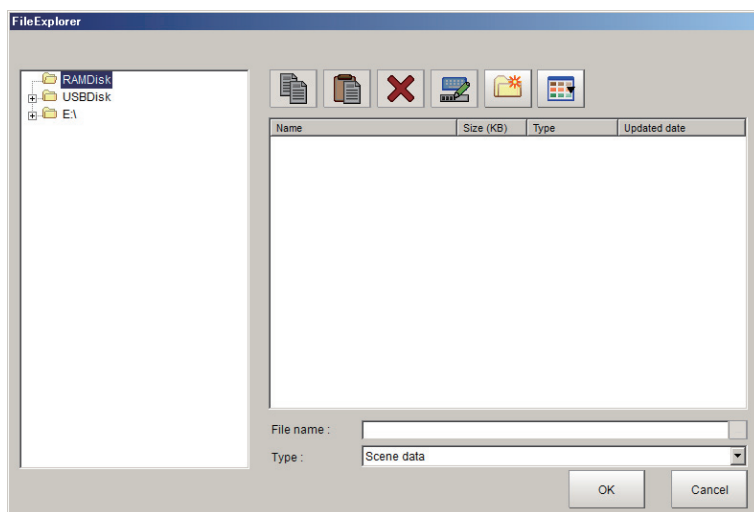

- 2 Click a scene data to read.

- 3 Click [OK].  
"Confirmation of overwrite" dialog box is displayed.

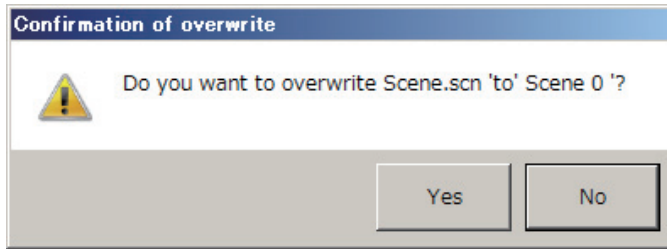

- 4 Click [Yes].

### ● Loading a scene data + registration image

- 1 Click [Scene data + registration image].  
"Select folder" dialog box is displayed.

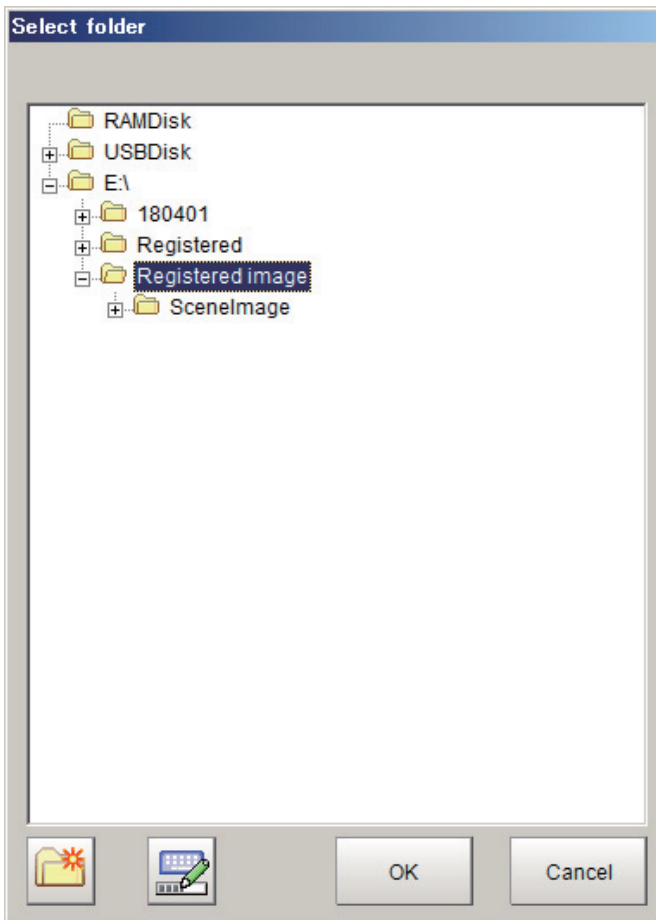

- 2 Select a folder containing a scene data and registered images to load.

**3** Click [OK].

“Confirmation of overwrite” dialog box is displayed.

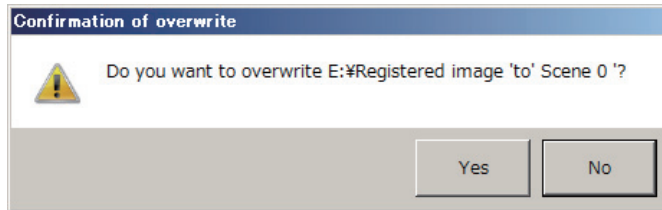
**4** Click [Yes].

“Confirmation of overwrite” dialog box is displayed.

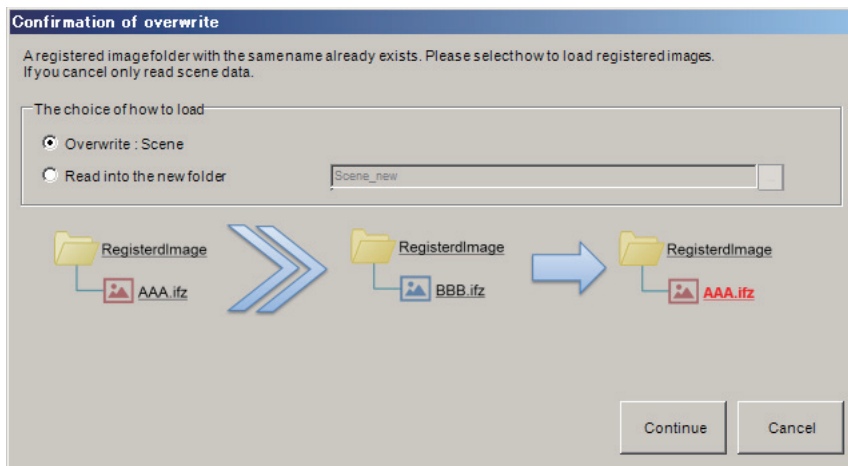
**5** Select a loading method.

a. Overwrite:

(1) Click [Continue].

b. Read into the new folder:

(1) Click [Read into the new folder] and enter the folder name in the text box.

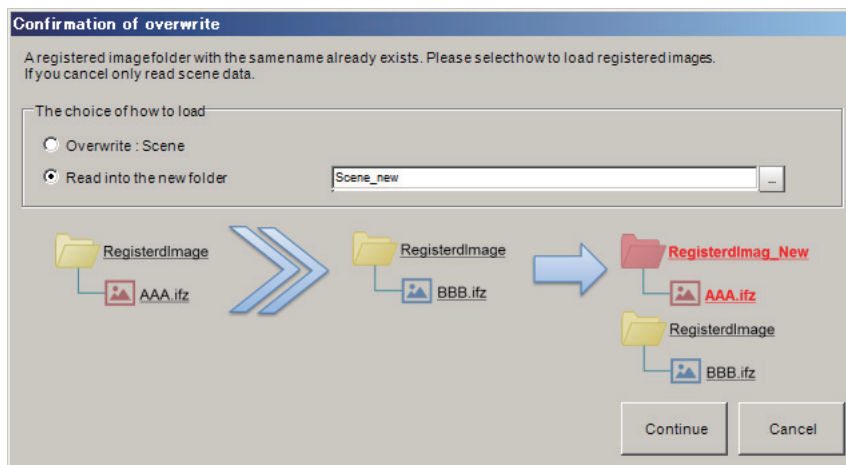

(2) Click [Continue].

## Saving a scene

- 1 Select the Scene tab on the Edit flow screen.  
A list of scenes is displayed. The current scene has a check mark.
- 2 Select a scene on the scene list to save and click  [Save].

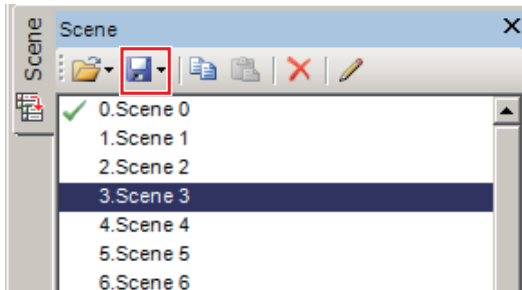

- 3 Select whether to save the scene data or to save the scene data and the registered images together.

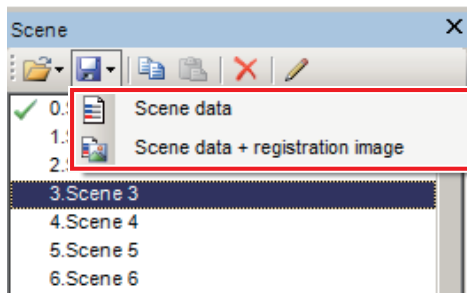

### ● Saving a scene data

“FileExplorer” is displayed.

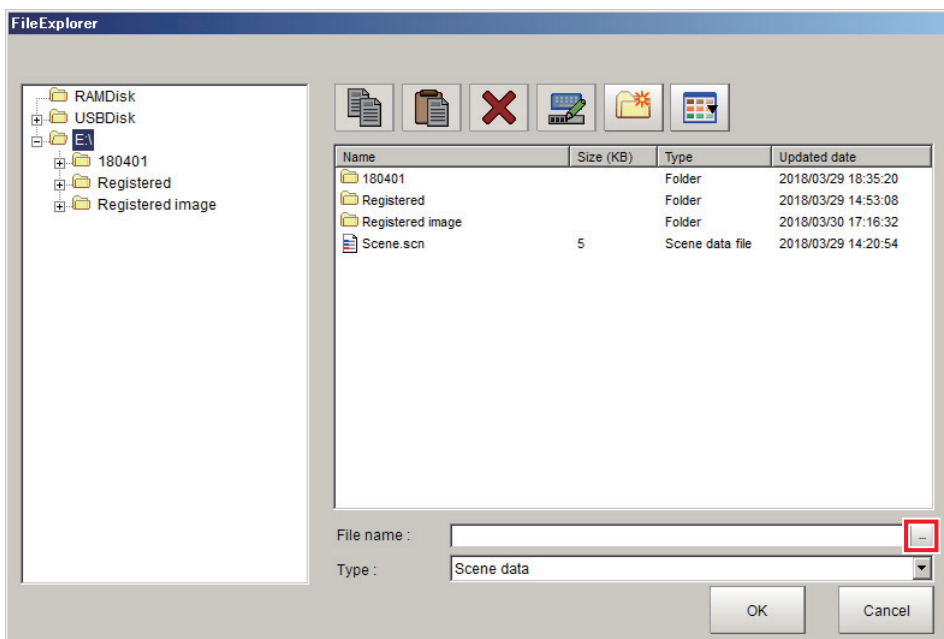

- 1 Select a folder to save the scene data of the selected scene in the scene list.

- 2** Click  on the right side of “File name” text box.  
“File name” dialog box is displayed.

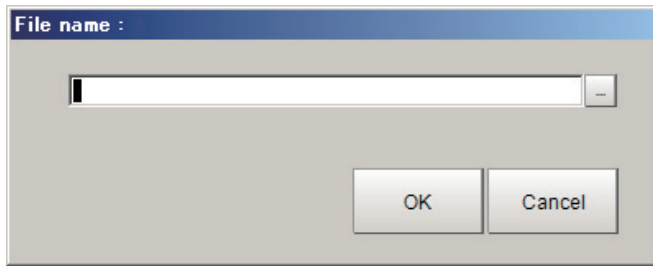

- 3** Enter the file name in the text box.

- 4** Click [OK].

A scene data file with the specified file name and “scn” extension is created.  
Example: In the case where the folder is “E:\” and the file name is “Scene0”.

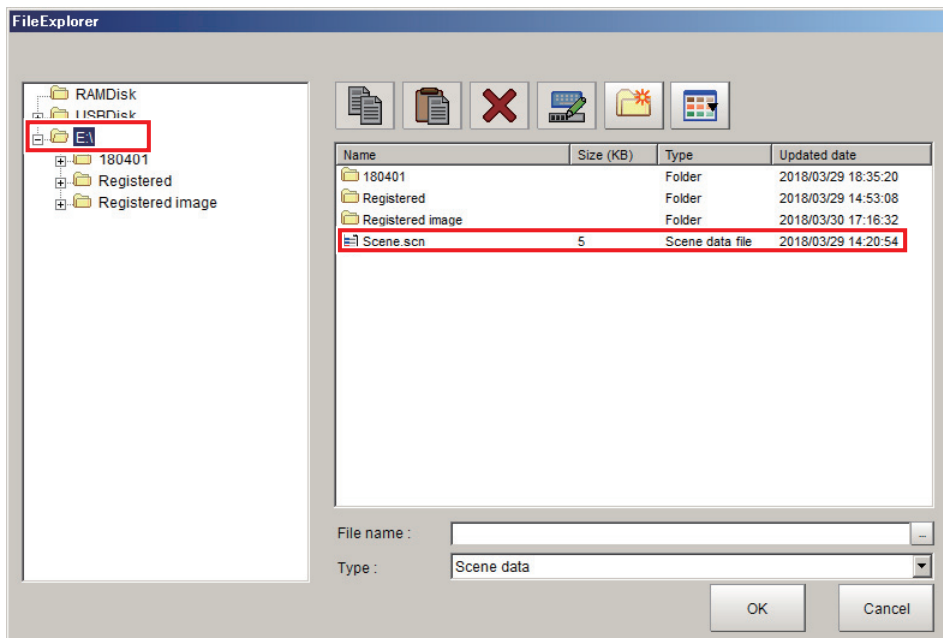

### ● Saving a scene data and registration image

“Scene data + registration image” dialog box is displayed.

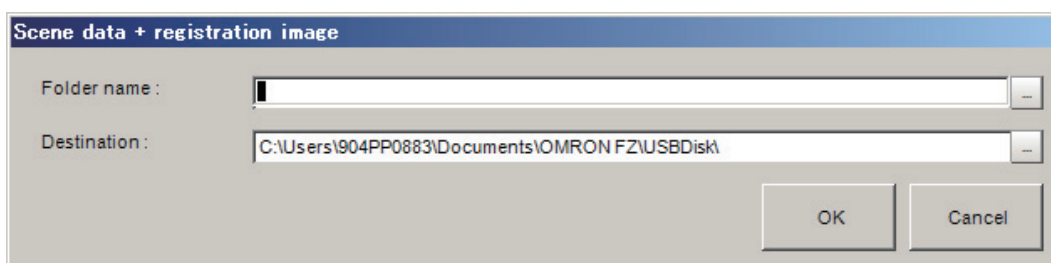

- 1 Click  on the right side of the "Destination" text box.  
"Select folder" is displayed.

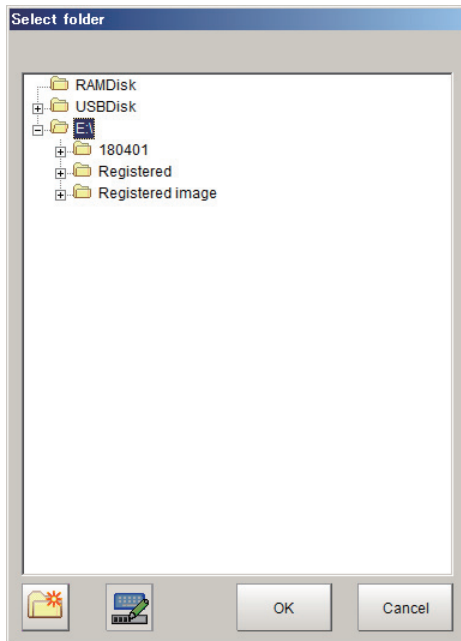

- 2 Select a folder for the saving destination.
- 3 Click [OK].
- 4 Enter a folder name into "Folder name" text box.
- 5 Click [OK].

The scene data file and registration image folder are created.

Example: In the case where the saving destination is "E:\", the folder name is "Scene2".

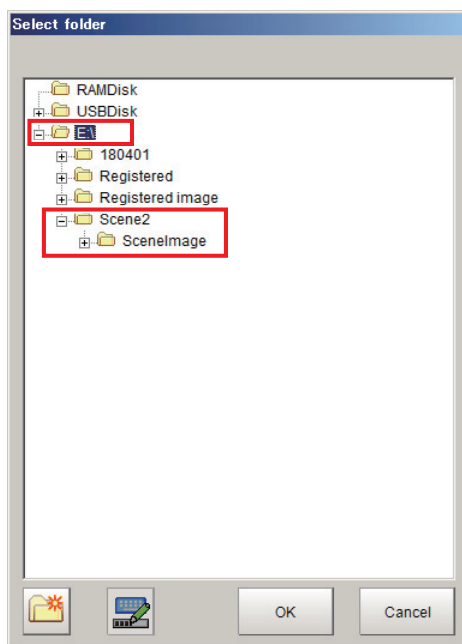



### Additional Information

The scene data file name and registration image folder name are fixed.

- Scene data file name: Scene.scn
- Registration image folder name: SceneImage

If the same file name and folder name have already existed in the specified folder, the following warning message is displayed.

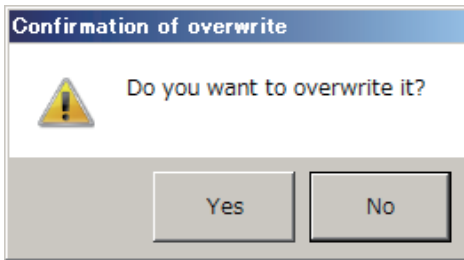

If OK, then click [Yes].

## Copying a Scene

- 1 Select the Scene tab on the Edit flow screen.  
A list of scenes is displayed. The current scene has a check mark.
- 2 Select a scene on the scene list to copy and click  [Copy].

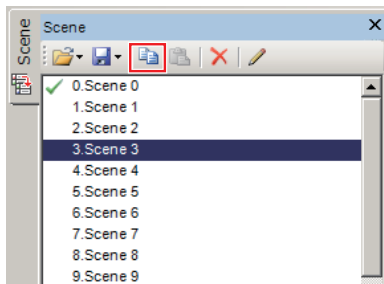

- 3 On the scene list, select a scene to paste and click  [Paste].  
A “Confirmation of overwrite” dialog will be displayed.

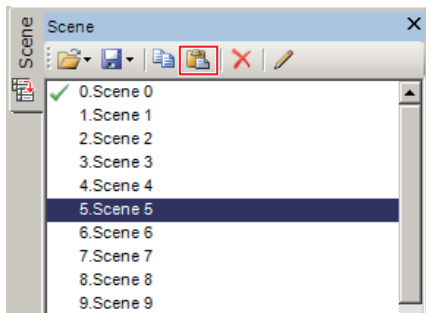

- 4 Click [OK].  
The copied scene is overwritten to the selected scene.

## Deleting a Scene

- 1 Select the Scene tab on the Edit flow screen.  
A list of scenes is displayed. The current scene has a check mark.
- 2 Select a scene on the scene list to delete and click  [Delete].  
A “Confirm clear” dialog is displayed.

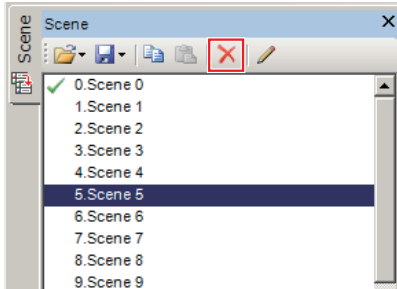

- 3 Click [OK].  
The selected scene is deleted.

## Editing Name or Description of a Scene

- 1 Select the Scene tab on the Edit flow screen.  
A list of scenes is displayed. The current scene has a check mark.
- 2 Select a scene on the scene list to edit and click  [Editing].

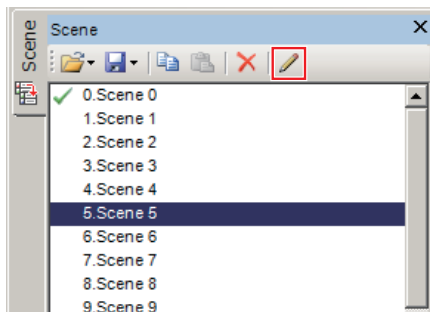

The “Scene maintenance” dialog is displayed.

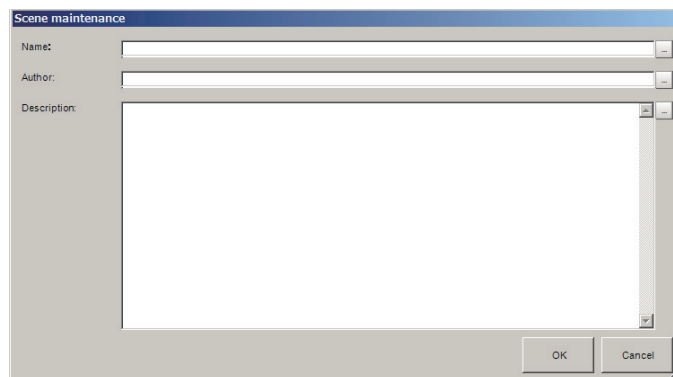

- 3 Edit the “Name”, “Author”, and “Description”.  
Name: Max. 15 characters (No accented or special characters)  
Author: Max. 15 characters  
Description: Up to 255 characters





### Additional Information

When entering characters into the “Description”, enter a line-break after 32 double-byte characters or 17 single-byte characters. If not, the characters will be overflowed and unable to be displayed.

**4** Click [OK].

## 5-5-4 Using Variables

Using variables can hold data such as parameters and measurement results of processing items, and reference or calculate data between processing units or between scenes.

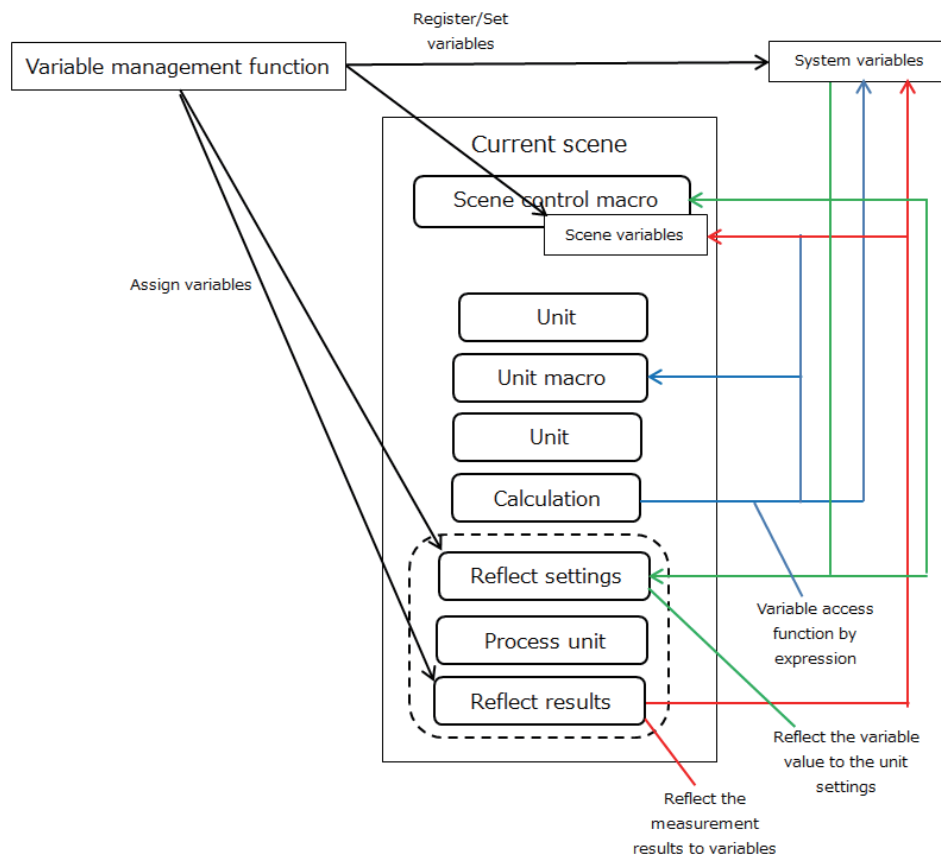

There are two kinds of variables as shown below.

**Scene variable:** Available in a defined scene. It cannot be set or referenced across scenes.

**System variable:** Available in a defined line. It can be set or referenced across scenes or scene groups, but cannot be set or referenced on different lines in Multiple line random mode.

In the Scene variable tab screen or the System variable tab screen, variables can be registered, deleted, changed, and assigned.

For more details, refer to *5-5-1 Edit Flow Screen* on page 5-14.

The number of variables that can be used depends on the amount of “Remaining variable definitions”. Check it on the Scene variable tab screen or System variable tab screen.

When defining variables, you can choose whether a variable holds the current value when the power is turned off, or is reset.

Variables are also used in Macro Customize Functions.

For details, refer to *FH/FHV/FZ5 Series Macro Customization Programming Manual (SDNB-721)*.

In a flow in which variables are used, the parallel processing is restricted. Refer to restrictions and setting method of parallelization function.

For details, refer to *Restrictions and Setting Procedures* in *4-4-2 Parallel Processing* on page 4-29.

## Adding variables

Variables need to be defined the name and the type before use.

- 1 On the Edit item tab area in the Edit flow tab screen, click [Scene variable] tab or [System variable] tab.

The Scene variable tab screen or the System variable tab screen is displayed.

The following is an example of the Scene variable tab screen.

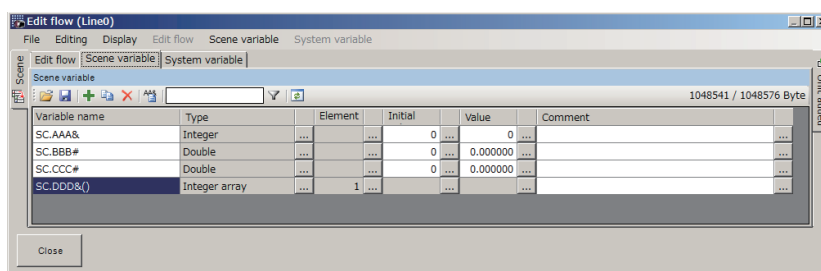

- 2 In the Variable button area, click  [Add].

The “Add” dialog box is displayed.

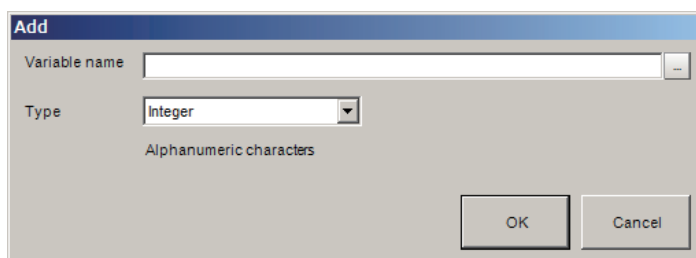

### Additional Information

The following operation also makes the TDM editor exit and return to the main screen, while holding the set contents.

- Click [Add] on the displayed shortcut menu of [Scene variable] or [System variable] in the Menu bar.
- When some variables have already defined, right-click a variable on the column of the variable name and click [Add] on the displayed shortcut menu.

- 3 Enter the name of the variable.



### Important

Variable names have the following restrictions. The restrictions are applied to both variables: Scene variables and System variables.

- The first character must be an alphabetic character.
- Alphanumeric characters, “.” (Period), and “\_” (Underscore) can be used except for the first character.
- Upper- and lowercase letters are not distinguished. When a lowercase letter is entered, it will be converted to and displayed as an uppercase one automatically. Therefore, just use upper- or lowercase letters. e.g. “AA” and “aa” are treated as the same variable.
- Reserved words cannot be used as a variable name. A variable name including a reserved word however can be used. e.g. “Abs” is one of the reserved words, so that it cannot be used as a variable name. “Abs\_01” however can be used as a variable name. For more details, refer to *List of Reserved Words on Macro Reference List* in *FH/FHV/FZ5 Series Macro Customization Programming Manual (SDNB-721)*.

- 4** Click [▼] on the right side of the “Type” text box to select the type of the variable.  
A list of the types will be displayed.

Constant type	Type identifier	Description	Data range	No. of bytes per data
Integer	&	It can handle signed integer type numbers and will be reset to the factory default with power off.	-214783648 to 2147483647	4 bytes
Integer (Save)	&&	It can handle signed integer type numbers and holds the value just before power off.	-2147483648 to 2147483647	4 bytes
Integer array	&()	It can handle multidimensional arrays of signed integer types and will be reset to the factory default with power off. Define the array on the “Array definition form” dialog.	-2147483648 to 2147483647	4 bytes (1 element)
Integer array (Save)	&&()	It can handle multidimensional arrays of signed integer types and holds the value just before power off. Define the array on the “Array definition form” dialog.	-2147483648 to 2147483647	4 bytes (1 element)
Double	#	It can handle real type numbers and will be reset to the factory default with power off.	-1.0E30 to 1.0E30	8 bytes
Double (Save)	##	It can handle real type numbers and holds the value just before power off.	-1.0E30 to 1.0E30	8 bytes
Double array	#()	It can handle multidimensional arrays of real type numbers and will be reset to the factory default with power off. Define the array on the “Array definition form” dialog.	-1.0E30 to 1.0E30	8 bytes (1 element)
Double array (Save)	##()	It can handle multidimensional arrays of real type numbers and holds the value just before power off. Define the array on the “Array definition form” dialog.	-1.0E30 to 1.0E30	8 bytes (1 element)
string	\$	It can handle string data and will be reset to the factory default with power off. You can enter alphanumeric symbols and characters in the language selected in the startup settings. Both half-width and full-width characters are treated as one character.	Up to 255 characters	-
String (Save)	\$\$	It can handle string data and holds the value just before power off. You can enter alphanumeric symbols and characters in the language selected in the startup settings. Both half-width and full-width characters are treated as one character.	Up to 255 characters	-
String array	\$()	It can handle multidimensional arrays of string data and will be reset to the factory default with power off. You can enter alphanumeric symbols and characters in the language selected in the startup settings. Both half-width and full-width characters are treated as 1 character. Define the array on the “Array definition form” dialog.	Up to 255 characters	-
String array (Save)	\$\$()	It can handle multidimensional arrays of string data and holds the value just before power off. You can enter alphanumeric symbols and characters in the language selected in the startup settings. Both half-width and full-width characters are treated as 1 character. Define the array on the “Array definition form” dialog.	Up to 255 characters	-

### 5 Click on [OK].

The variable set is added to the end of the variable list with the following definition.

Integer type: Initial value = 0, value = 0, Comment: <empty string>

Floating point type: initial value = 0, value = 0.000000, Comment: <empty string>

Character string type: initial value = <empty string>, value = <empty string>, comment: <empty string>



#### **Additional Information**

---

The variable name displayed in the variable list is displayed as (\*\*. Variable name \*\*) with the type of variable and type identifier appended.

For Variable type, there are two types defined, SC (Scene variable) and SY (System variable).

The following is an example for the variable name "abc".

- Scene variable with "Integer": SC.abc&
  - Scene variable with "Integer (Save)": SC.abc&&
  - System variable with "Real number": SY.abc#
  - System variable with "String array": SY.abc()
-

## Editing Name and Type of a Variable

- 1 On the Edit item tab area in the Edit flow tab screen, click [Scene variable] tab or [System variable] tab.

The Scene variable tab screen or the System variable tab screen is displayed.

The following is an example of the Scene variable tab screen.

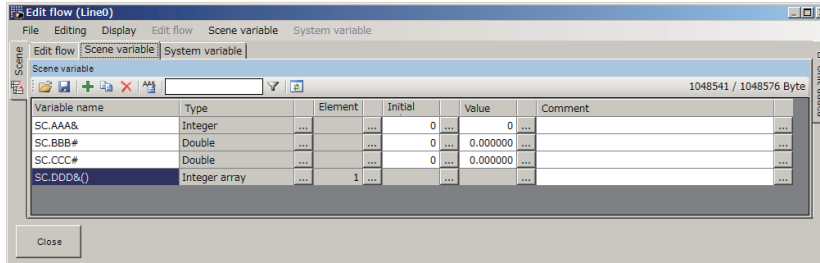

- 2 On the Variable list area, select a variable name to edit.

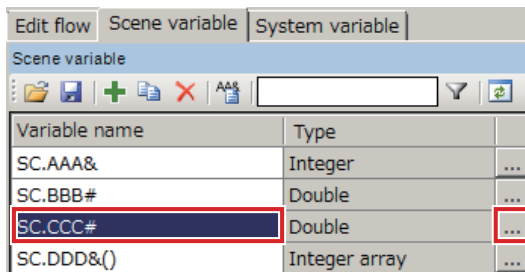

### Additional Information

The following operation also enables variable names to edit.

- Click the variable name to edit.

- 3 Click [...] at the right of the “Type” column for the selected variable.  
The “Rename” dialog box is displayed.

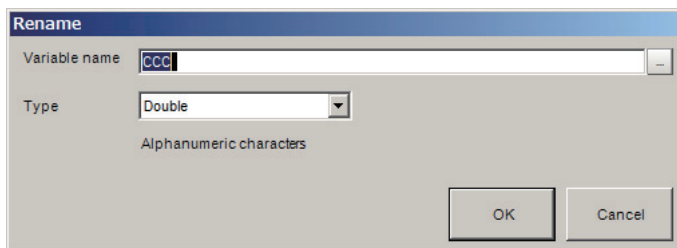

- 4 Edit the “Variable name” and the “Type”.
- 5 Click [OK] to end the input.

## Editing Number of Elements of an Array Type Variable

When Array type variables are used, set the number of elements.

- 1 On the Edit item tab area in the Edit flow tab screen, click [Scene variable] tab or [System variable] tab.

The Scene variable tab screen or the System variable tab screen is displayed.

- 2 On the Variable list area, select an array variable name to edit.

Variable name	Type	Element
SC.AAA&	Integer	...
SC.BBB#	Double	...
SC.CCC#	Double	...
SC.DDD&()	Integer array	1

- 3 Click [...] at the right of the “Element” column for the selected variable.

The “Array definition form” dialog is displayed.

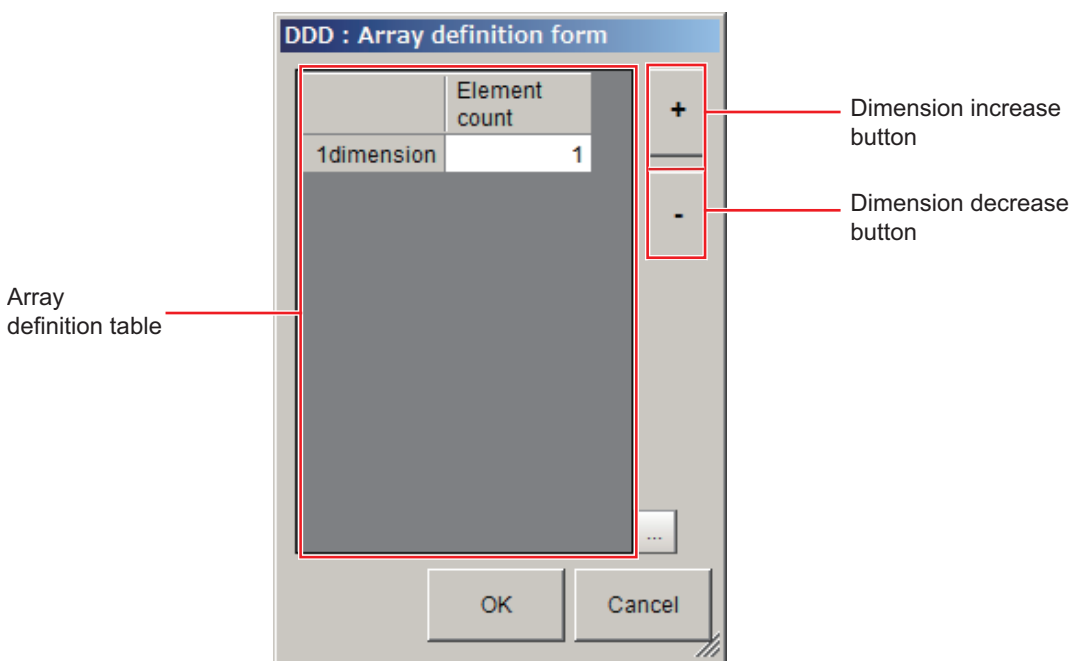

- 4 Edit the Variable array.  
Using “+” (increase) / “-” (decrease) buttons, set the number of the dimension with integer value up to 4.

Click the “Element count” input text box in the “Array definition table” to set the number of elements in each dimension with integer up to 1,024.

### Important

The maximum number for the number of dimensions x number of elements is 10,240. If a number exceeding the maximum were set, an error dialog will be displayed when clicking [OK].

- 5 Click [OK].

## Editing the Initial Value of a Variable.

- **Non-array Type Variables:**

- 1** On the Edit item tab area in the Edit flow tab screen, click [Scene variable] tab or [System variable] tab.  
The Scene variable tab screen or the System variable tab screen is displayed.
- 2** On the Variable list area, select a variable name to edit.
- 3** Click [...] at the right of the “Initial” column for the selected variable.

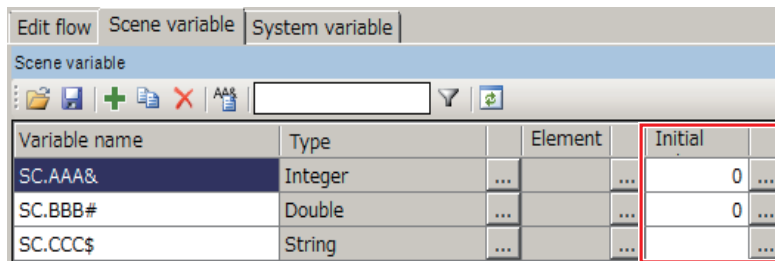

The “Initial value set form” dialog box is displayed.

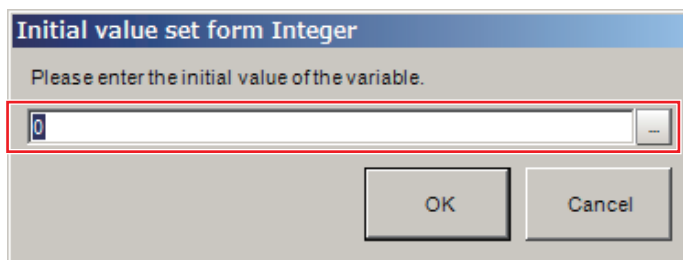

- 4** Directly enter a value into the input text box or click [...] for it.
- 5** Click [OK] to end the input.

● **One- or Two-dimension Array Type Variables:**

- 1** Click [...] at the right of the “Initial” column for the selected variable.

Variable name	Type	Element	Initial
SC.AAA&&()	Integer array(save)	4	
SC.BBB##()	Double array(save)	2,5	
SC.CCC\$()	String array	6,9	

The “Initial value set form” dialog box is displayed. The following example is that the number of one-dimensional elements is “2” and the number of two-dimensional elements is “5”.

	0,0	0,1	0,2	0,3	0,4
0,0	0	0	0	0	0
1,0	0	0	0	0	0

The matrix is displayed according to the number of elements in one-dimensional and two-dimensional. The matrix may not fit into the dialog box size depending on the number of elements. In that case, drag the bottom-right corner of the dialog box to adjust the dialog box size.

- 2** Click a value cell on the matrix to directly enter the initial value for the array element.  
When an array element is not displayed in the dialog, drag the scroll bar to find the array element.
- 3** Click [OK] to end the input.



● **Three- or more dimension Array Type Variables:**

- 1 Click [...] at the right of the “Initial” column for the selected variable.

Variable name	Type	Element	Initial
SC.AAA&&()	Integer array(save)	4	...
SC.BBB##()	Double array(save)	2,3,5	...

The “Initial value set form” dialog box is displayed. The matrix may not fit into the dialog box size depending on the number of elements. In that case, drag the bottom-right corner of the dialog box to adjust the dialog box size. In the title bar, the variable type is also displayed.

The following example is that the number of one-dimensional elements is “4”, the number of two-dimensional elements is “5”, and the number of three-dimensional elements is “6”.

Element	Value
0,0,0	0
0,0,1	0
0,0,2	0
0,0,3	0
0,0,4	0
0,1,0	0
0,1,1	0
0,1,2	0
0,1,3	0
0,1,4	0
0,2,0	0

- 2 Enter an element number to set the initial value in the “Search” input text box by the format displayed on the “Element column”.

Each element in the “Element column” is comma-delimited. (One-dimensional element number, Two-dimensional element number, Three-dimensional element number).

**3** Click [Move].

The current cursor on the “Value” column will be moved to the cell on the “Value” column of the element number searched. The following example is that the number of one-dimensional element number is “1”, the number of two-dimensional elements is “2”, and the number of three-dimensional elements is “3”.

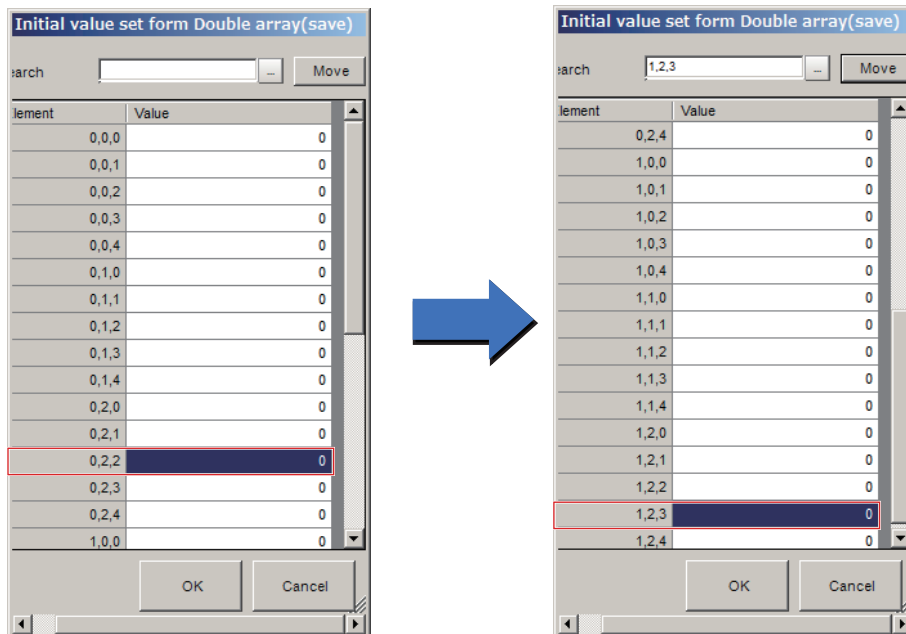
**4** Click the cell to enter the initial value.**Additional Information**

The following operation also enables initial values to enter into cells in the “Value” column.

- Drag the scroll bar of the “Initial value set form” dialog box for the three- or more dimensional array type to find a cell to set the initial value. Click the cell to enter the initial value.

**5** Click [OK] to end the input.

## Editing Values

- **Non-array Type Variables:**

- 1** On the Edit item tab area in the Edit flow tab screen, click [Scene variable] tab or [System variable] tab.  
The Scene variable tab screen or the System variable tab screen is displayed.
- 2** On the Variable list area, select a variable name to edit.

- 3 Click [...] at the right of the “Value” column for the selected variable.

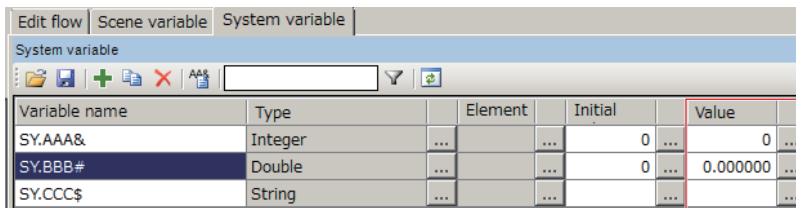

The “Value set form” dialog box is displayed.

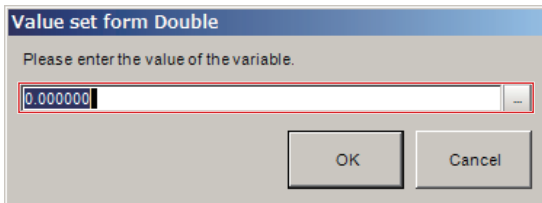

- 4 Directly enter a value into the input text box or click [...] for it.
- 5 Click [OK] to end the input.

● **One- or Two-dimension Array Type Variables:**

- 1 Click [...] at the right of the “Value” column for the selected variable.

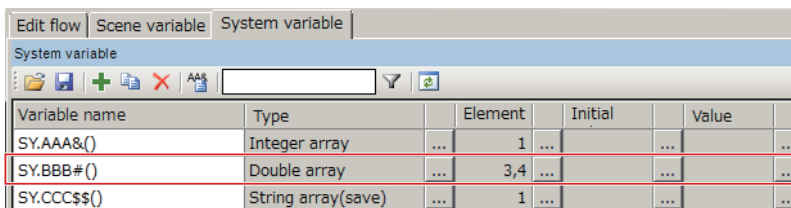

The “Value set form” dialog box is displayed. The following example is that the number of one-dimensional elements is “3” and the number of two-dimensional elements is “4”.

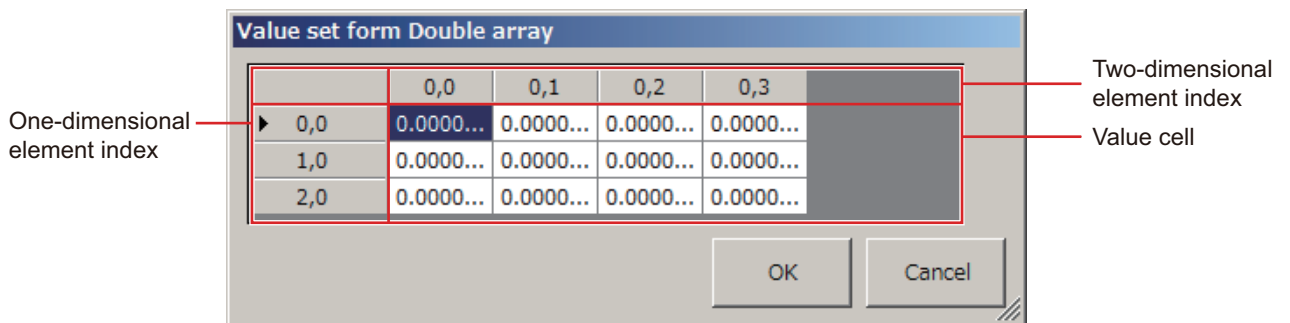

The matrix is displayed according to the number of elements in one-dimensional and two-dimensional. The matrix may not fit into the dialog box size depending on the number of elements. In that case, drag the bottom-right corner of the dialog box to adjust the dialog box size.

- 2 Click a value cell on the matrix to directly enter the value for the array element.  
When an array element is not displayed in the dialog, drag the scroll bar to find the array element.
- 3 Click [OK] to end the input.

● **Three- or more dimension Array Type Variables:**

- 1 Click [...] at the right of the “Value” column for the selected variable.

Variable name	Type	Element	Initial	Value
SY.AAA&()	Integer array	4,7 ...	...	...
SY.BBB#()	Double array	4,5,6 ...	...	...

The “Value set form” dialog box is displayed. The matrix may not fit into the dialog box size depending on the number of elements. In that case, drag the bottom-right corner of the dialog box to adjust the dialog box size. In the title bar, the variable type is also displayed.

The following example is that the number of one-dimensional elements is “2”, the number of two-dimensional elements is “3”, and the number of three-dimensional elements is “5”.

Element	Value
0,0,0	0.000000
0,0,1	0.000000
0,0,2	0.000000
0,0,3	0.000000
0,0,4	0.000000
0,0,5	0.000000
0,1,0	0.000000
0,1,1	0.000000
0,1,2	0.000000
0,1,3	0.000000
0,1,4	0.000000
0,1,5	0.000000
0,2,0	0.000000
0,2,1	0.000000
0,2,2	0.000000
0,2,3	0.000000

- 2 Enter an element number to set the value in the “Search” input text box by the format displayed on the “Element column”.

Each element in the “Element column” is comma-delimited. (One-dimensional element number, Two-dimensional element number, Three-dimensional element number).

**3** Click [Move].

The current cursor on the “Value” column will be moved to the cell on the “Value” column of the element number searched. The following example is that the number of one-dimensional element number is “1”, the number of two-dimensional elements is “2”, and the number of three-dimensional elements is “3”.

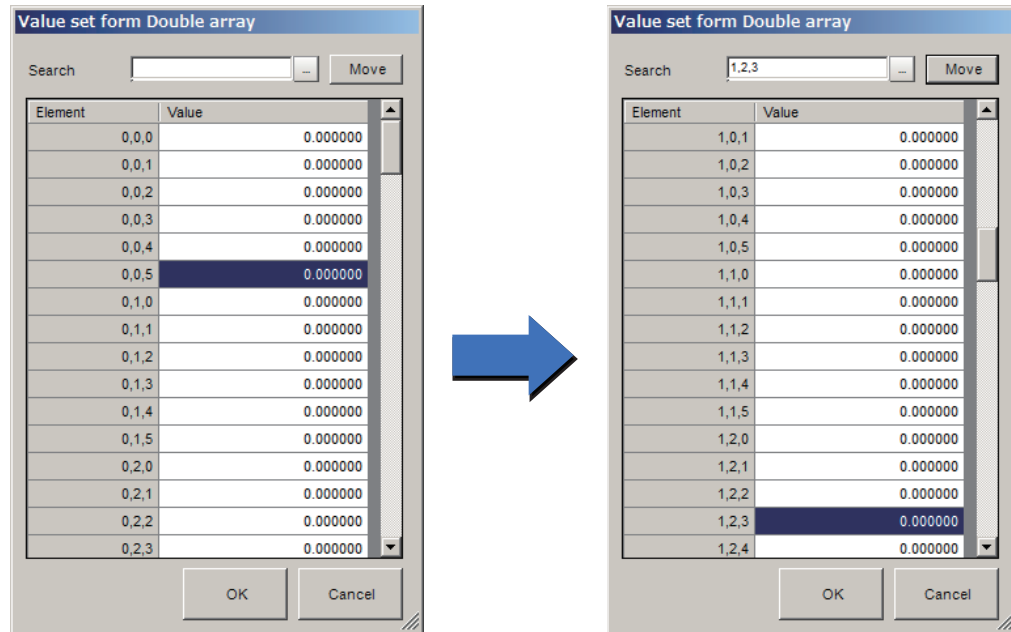
**4** Click the cell to enter the value.**Additional Information**

The following operation also enables values to enter into cells in the “Value” column.

- Drag the scroll bar of the “Value set form” dialog box for the three- or more dimensional array type to find a cell to set the initial value. Click the cell to enter the value.

## Editing Comments of a Variable

Comments can be added to each variable.

The number of characters is up to 200 characters regardless of half-width or full-width.



### Additional Information

For FH series, multilingual input is available.

For the input method, refer to 3-2-2 *Inputting Text* on page 3-7.

- 1** On the Edit item tab area in the Edit flow tab screen, click [Scene variable] tab or [System variable] tab.  
The Scene variable tab screen or the System variable tab screen is displayed.
- 2** On the Variable list area, select a variable name to edit.
- 3** Click [...] at the right of the “Comment” column for the selected variable.

Variable name	Type	Element	Initial	Value	Comment
SY.AAA&	Integer	...	0	0	...
SY.BBB\$	String	...			...

The “Comment” dialog box is displayed.

**Comment**

Comment

Semicolon can not be used in comment.

OK Cancel

- 4** Click the “Comment” input text box or [...] to enter or edit the comment.
- 5** Click [OK] to end the input or edit.

## Saving/Loading Variables

Variables edited or added can be saved or loaded in a CSV file format.



### Important

- Variables are saved with the following format in a CSV file.

The following is an example using two variables (abc and def).

The Variable name is "abc", the Type is "Integer array", the number of one-dimensional elements is "2", and the number of two-dimensional elements is "3".

The values are (0,0)=1, (0,1)=2, (0,2)=3, (1,0)=4, (1,1)=5, (1,2)=6, and the comment is "xyz".

The Variable name is "def", the type is "Integer", the value is "0", and the comment is "uvw".

"Variable name", "Array element", "Comment", "Default value", "Value"

"abc&(1,2)", "", "xyz"

,"0,0", "", "0", "1"

,"0,1", "", "0", "2"

,"0,2", "", "0", "3"

,"1,0", "", "0", "4"

,"2,1", "", "0", "5"

,"3,2", "", "0", "6"

"def&", "", "uvw", "0", "0"

- When saving variables in a CSV file, UTF-8 encoding is applied as the character code. Therefore, when an application that is not compatible with UTF-8 opens the CSV file, it may cause garbled characters.

## ● Saving Variables

- 1** On the Edit item tab area in the Edit flow tab screen, click [Scene variable] tab or [System variable] tab.

The Scene variable tab screen or the System variable tab screen is displayed.

- 2** On the Variable button area, click  [Save].

The FileExplorer is displayed. For details, refer to 3-2-3 *Selecting Files and Folders* on page 3-10.

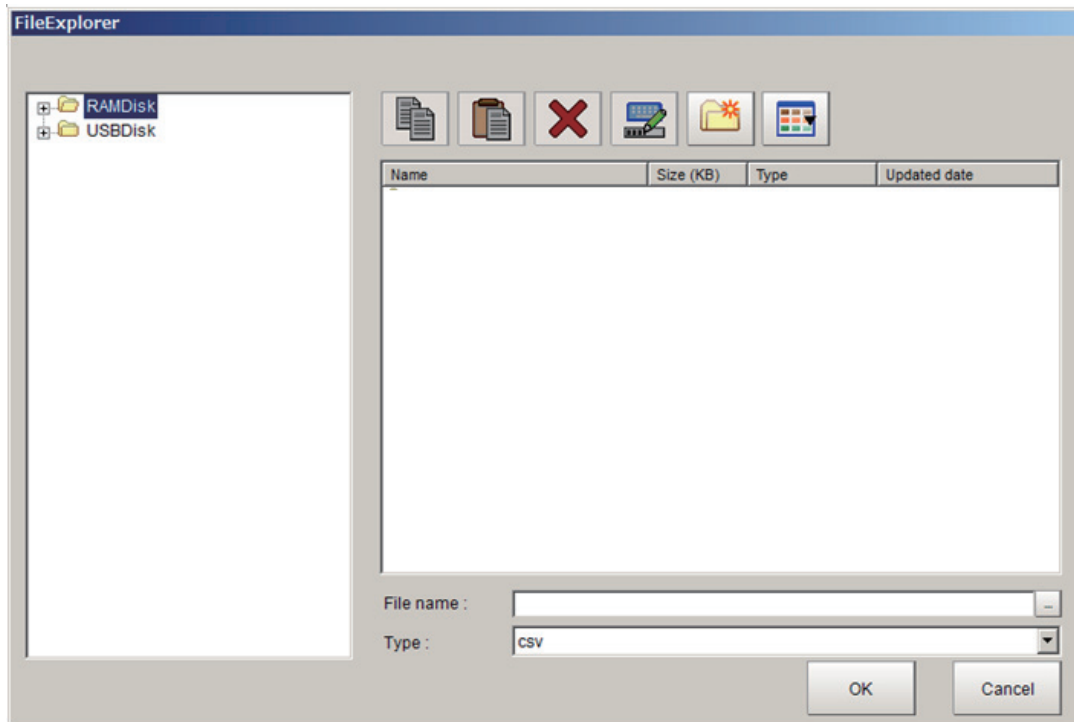

### Additional Information

The following operation also enables variables to save.

- Click [Save] on the shortcut menu displayed when clicking [Scene variable] or [System variable] in the Menu bar.
- Right-click a variable on the variable list and then click [Save] on the shortcut menu displayed.

- 3** Set the save destination folder and file name, and then click [OK].

Variables being used are saved in a CSV file. When clicking [Save] on the Scene variable tab screen, all the scene variables displayed on the screen are saved. Likely, when clicking [Save] on the System variable tab screen, all the system variables displayed on the screen are saved.

## ● Loading Variables

- 1** On the Variable button area, click  [Open].

The FileExplorer is displayed. For details, refer to 3-2-3 *Selecting Files and Folders* on page 3-10.

- 2** Set the folder and file name to be loaded and click [OK].

Variables saved in a CSV file format are loaded.



## Filtering variables

In the case where the number of variables has increased, setting a display filter can reduce the number of variables to be displayed on the Scene variable tab screen or System variable tab screen. In the display filter setting, specify the logical operation for the matching character strings and the matching character strings included in the variable names to display. Display the applicable variables based on the result of the filter setting.

- 1 On the **Edit item tab area in the Edit flow tab screen**, click **[Scene variable] tab** or **[System variable] tab**.

The Scene variable tab screen or the System variable tab screen is displayed.

- 2 On the **Variable button area**, click  **[Filter]**.

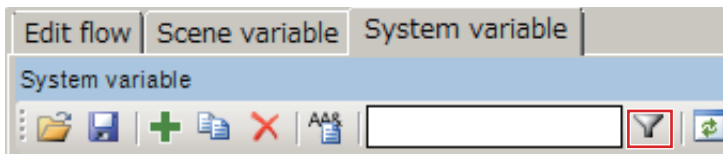

The “Filter setting” dialog box is displayed.

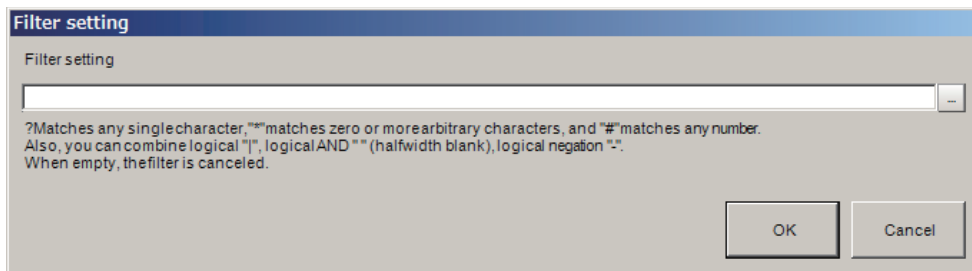

- 3 Click **[...]** at the right of the “Filter setting” input text box and enter a matching character string or a logical operation formula.

Enter a matching character string or a logical operation formula based on the following contents. When emptying the “Filter setting” input text box, a filter set is cleared and all variables will be displayed.

### ● Matching character string

Matching string	Description
?	A wild card representing an arbitrary character.
*	A wild card representing zero or more arbitrary characters.
#	A wild card representing an arbitrary number.
[<Character list>]	A wild card representing an arbitrary character included in <Character list>.
[!<Character list>]	A wild card representing an arbitrary character not included in <Character list>.



### Additional Information

- When matching “?” as a character and not a wild card, use [?] format.
- When matching “\*” as a character and not a wild card, use [\*] format.
- When matching “#” as a character and not a wild card, use [#] format.
- Using type identifiers such as “\$”, “&”, and “#” can filter a specific variable type.
- Using “()” can filter Array type variables.

● Matching character string

Logical operator	Description
" "	OR operator. " " indicates a half-width vertical line or pipe line character. Enter like A B.
" "	AND operator. " " indicates a half-width space character. Enter like A B.
"-"	NOT operator. "-" indicates a half-width minus character. Enter like -A.



**Additional Information**

Operator processing priority is (low) OR < AND < NOT (high).

Example: A|-B C (A OR NOT B AND C)

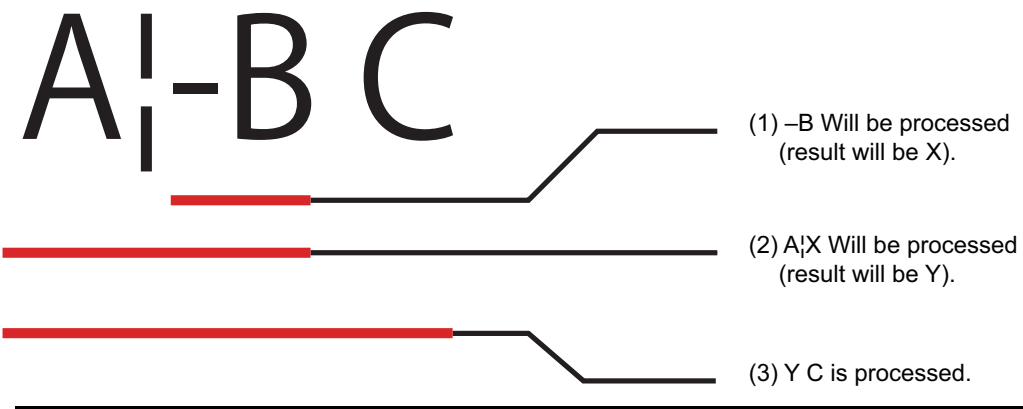

**1** Click the [OK].

The display will be below while setting the filter.

The mark displayed while filter is being set.

When the filter is set, it becomes a light blue background and the filter setting is displayed.

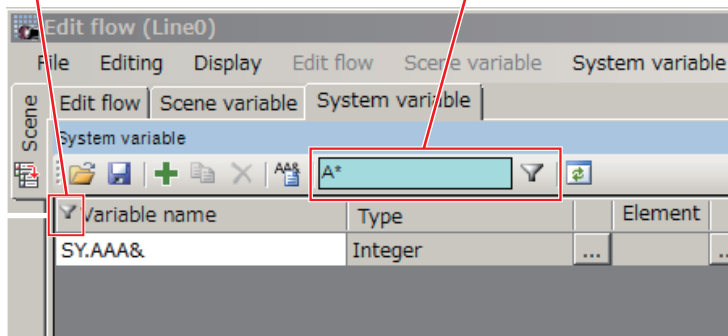

## Assigning variables

Assign defined variables to processing units. The method for assigning variables is the same for both Scene variables and System variables.

- 1** Click [Scene] tab on the Edit flow screen to select a scene from the displayed list to edit.  
A list of scenes is displayed. The current scene has a check mark.
- 2** Click [Edit flow] tab.  
The Edit flow tab screen is displayed.

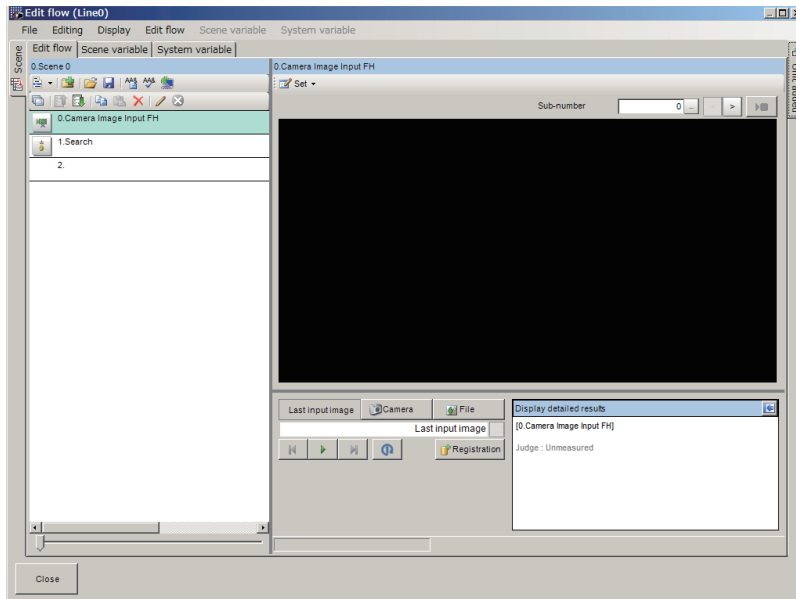

- 3** On the Unit list (flow), select a processing unit to assign variables.
- 4** Click [Set] on the Unit area and click [Open the unit setting UI].  
The "Editing" dialog box for the selected processing unit is displayed.

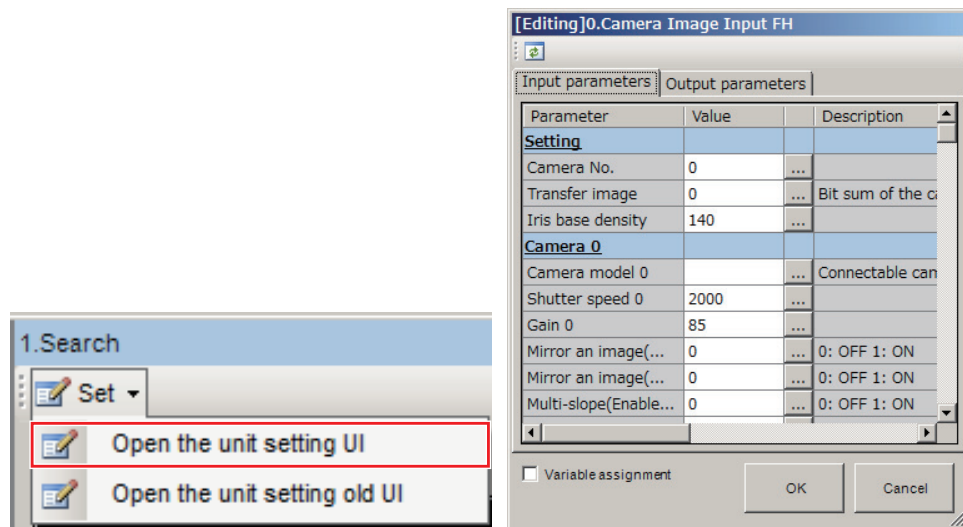

**5 Check the check box for the “Variable assignment”.**

The “Variable” column is displayed.

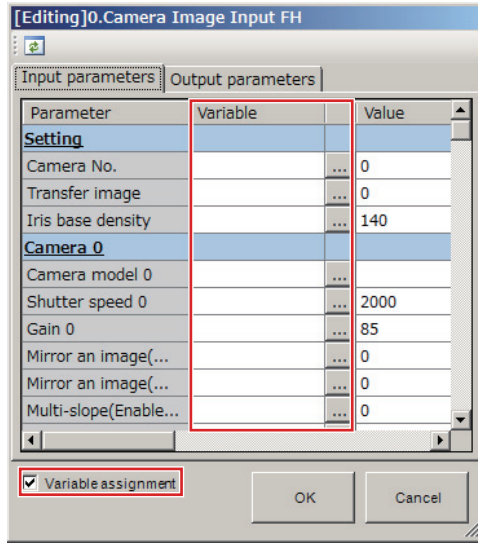

**6 In the “Input parameter” tab or “Output parameter” tab, select a parameter to assign a variable and click [...].**

The “Variable assignment” dialog box is displayed.

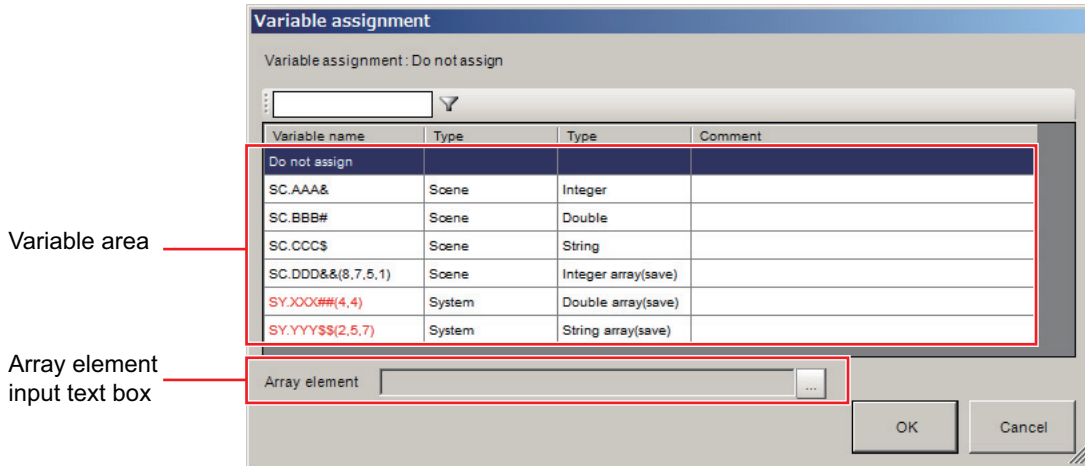

**7 For Array type variables, enter an element number to the “Array element input text box” with comma-delimited format.**

(One-dimensional element number, Two-dimensional element number, Three-dimensional element number)

**8 Click [OK].**

The assigned variables are reflected in the "Input parameter" tab and "Output parameter" tab of the “Editing” dialog box. When a variable is assigned to a parameter, the cell background color of the value becomes green. When a System variable is assigned to an Input parameter, the variable name is displayed in red.

**9 If there are variables to assign, repeat steps from 3 to 8.**



**Important**

- When a variable is assigned to an Input parameter, the value of the Scene variable or System variable is set for the data assigned before the measurement is processed. If a nonexistent variable is assigned, the assignment is ignored and the measurement is executed using the current data. In this case, it does not affect the judgment of the processing unit.
- When a variable is assigned to an Output parameter, the value of the Scene variable or System variable is set for the data assigned after the measurement is processed. If a nonexistent variable is assigned, the assignment is ignored. In this case, it does not affect the judgment of the processing unit.
- When arranging a parallelized flow using Parallelize processing items, arrange the flow by considering the execution timing of each variable.



**Additional Information**

- With a cell selected, its variable assignment setting can be deleted by depressing the [Del] key on the keyboard or clicking [Delete] on the shortcut menu displayed by right-clicking.
- With a cell selected, its variable assignment setting can be copied by depressing [Ctrl]+[C] on the keyboard or clicking [Copy] on the shortcut menu displayed by right-clicking.
- A copied variable assignment setting can be pasted to a selected cell by depressing [Ctrl]+[V] on the keyboard or clicking [Paste] on the shortcut menu displayed by right-clicking.
- With a cell selected to which an array variable with a numeric value in the index is assigned, copy it and select multiple cells to be sequentially assigned. Depress [Ctrl]+[B] on the keyboard or right-click and click [Sequential number paste] on the shortcut menu displayed. The copied variable assignment setting is pasted to the selected cells while incrementing the index number of the array variable by one.

Example:

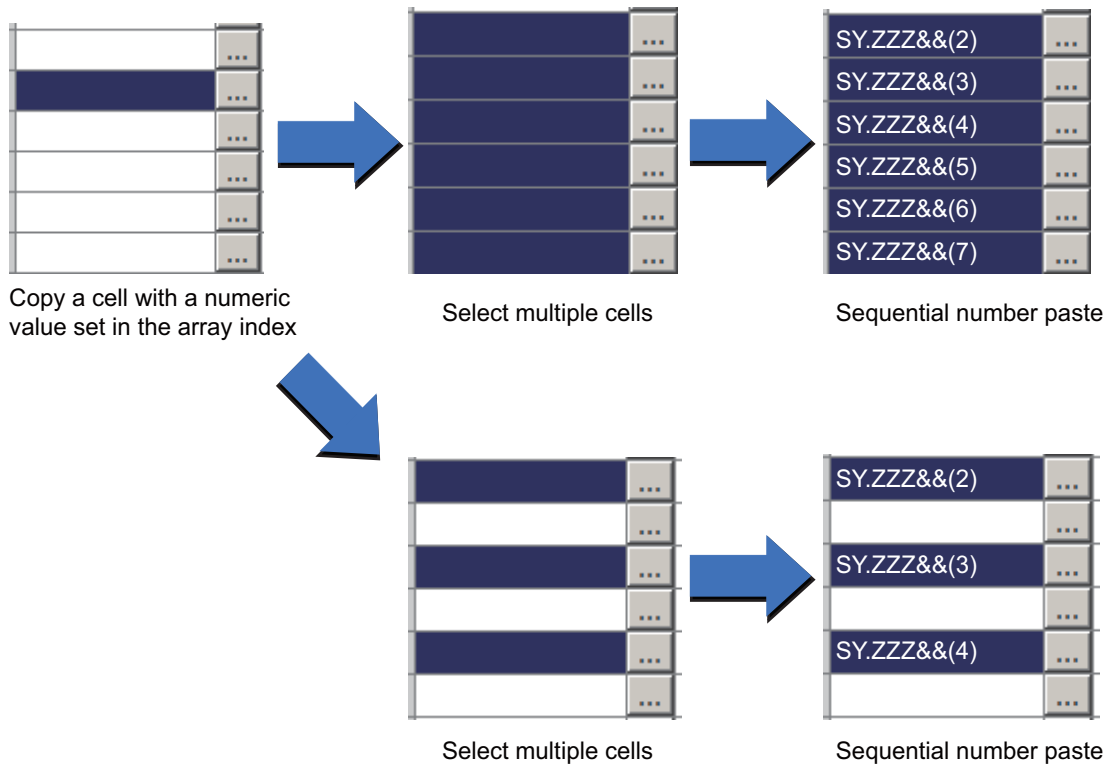

## Checking Variables

Check which variable is assigned to which processing unit and whether or not there is an undefined variable.

- 1 On the Variable button area, click  [Variable assignment list].

The “Variable assignment list” window is displayed.

The window displays the assignment list of the Scene variables and System variables in use.

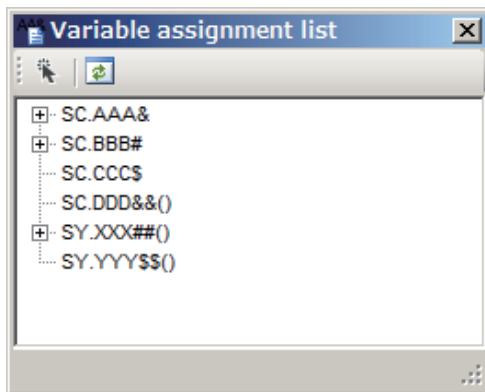

### Additional Information

The following operation also enables variables to check. If there are undefined variables, a warning dialog box will be displayed.

- Click [Variable check] in the shortcut menu displayed when clicking [Edit flow] in the Menu bar.
- Click [Variable check] icon on the Edit flow button area.

- 2 Check assigned variables in the “Variable assignment list” window.

### ● When variables are assigned to processing units:

A “+” is displayed at the head of the variable.

Clicking the “+” displays the assigned processing unit name.

Clicking the “+” at the head of the processing unit displays its parameters.

Double-clicking a variable displays the “Scene variable” tab screen or “System variable” tab screen depending on the variable.

Double-clicking the processing unit displays a parameter area of the variable on the Edit flow screen.

Check the processing unit and its assigned parameter values.

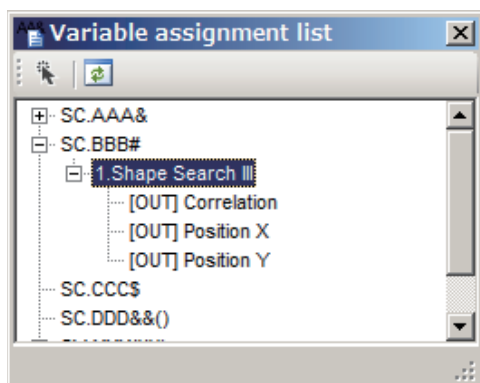

● **When variables are not assigned to processing units:**

A “+” is not displayed at the head of the variable.

Double-clicking a variable displays the “Scene variable” tab screen or “System variable” tab screen depending on the variable.

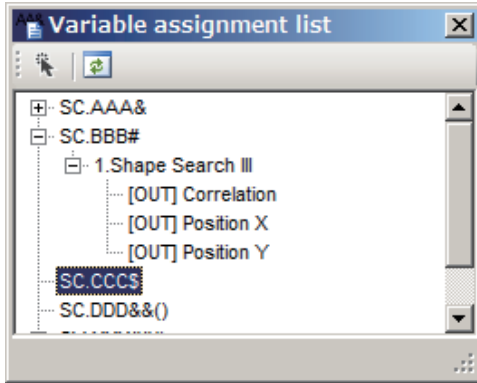

Assign the variable to processing units.

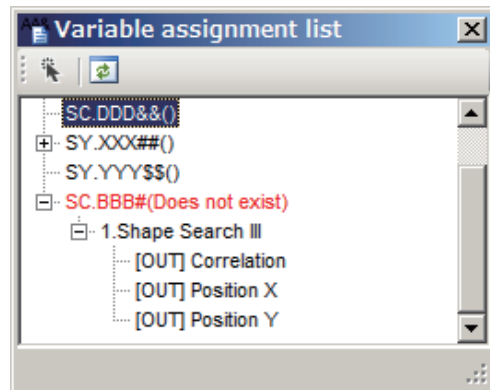

● **When undefined variables are assigned to processing units:**

An undefined variable may be assigned by copying from another scene or deleting the variable after assigning the variable. An undefined variable is displayed in red characters. A “+” is displayed at the head of the variable. Clicking “+” displays the assigned processing unit. Clicking “+” at the head of the processing unit displays its parameters. Check the variables themselves, the processing units and parameters assigned.



Icon/Button	Function	Description
	Select a processing unit	Sets the variable selected on the “Variable assignment list”. When a variable is selected, it moves to the “Variable list” of “Scene variable” or “System variable” tab screen. When a processing unit or parameter assigned to a variable is selected, it moves to the “Edit flow” tab screen of the corresponding processing unit.
	Update	Updates the Variable assignment list window.



**Additional Information**

If an unidentified variable existed, the following mark is displayed on the “Editing” window of the corresponding processing unit.

Unidentified variable mark

Correlation	SC.BBB#		...	0.000000	0.0000 to 100.0000
Position X	SC.BBB#		...	0.000000	-99,999.9999 to 99,999.9999
Position Y	SC.BBB#		...	0.000000	-99,999.9999 to 99,999.9999

Also, when closing the Edit flow screen while there are undefined variables, the following warning will be displayed.

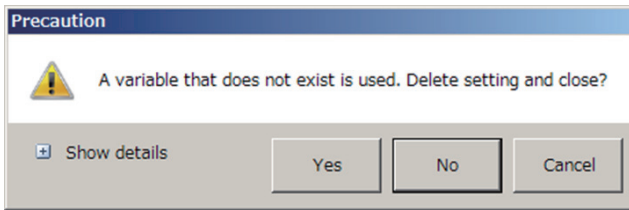

Click the "Show details" and check the details.

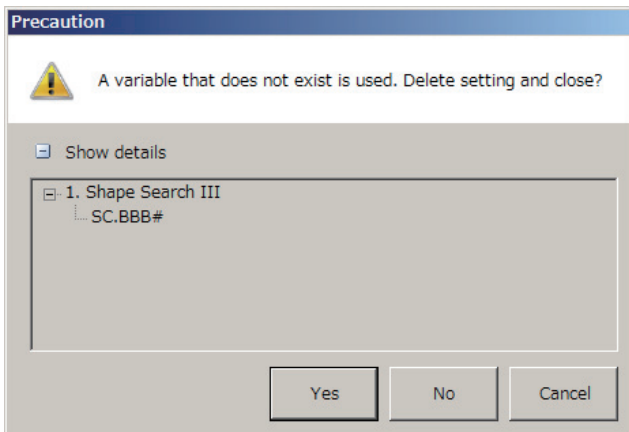

"Yes": Delete the nonexistent variable and close the Edit flow screen.

"No": Close the Edit flow screen without deleting the nonexistent variable.

"Cancel": Returns to the Edit flow screen.



## Cautions for Editing



### Additional Information

- When a processing unit is inserted, the numbers for the following processing units increase by one. With processing items related to results output or branch control, the numbers for processing units set as references also automatically increase by one.
- When a button other than [Paste] is clicked after pasting a processing unit, pasting the processing unit cannot be continued.
- When a processing unit is deleted, the numbers for the following processing units decrease by one. With processing items related to results output or branch control, the numbers for processing units set as references also automatically decrease by one.
- To hide a specific processing unit in the flow on an adjustment window or run window, insert a "\*" (single byte) at the head of the processing unit name.
- With the FZ-L series and FZ-600 series, the number of units that can be set in a flow depends on the available data memory.
- With the FH series or FZ5-800/1100/1200 series, a warning message is displayed when the amount of available application memory falls below 1 GB. Adjust the inspection flow so that the available memory is more than 1 GB. For details, refer to *3-4 Checking the Memory Consumption and Percentage of Memory Used* on page 3-31 and *3-3 Checking System Information* on page 3-27.
- When copying and pasting a processing unit that references other processing units such as a conditional branch processing unit, the branch destination of the pasted processing unit is initialized to [End processing]. When pasting whole processing units within a folder, a parallelization processing unit, or a parallelized task processing unit, references from inside the pasted block to outside the block are initialized to [End processing]. When copying and pasting a processing unit such as a calculation processing unit that references other processing units, the content of the expression of the pasted processing unit becomes #ERR. When pasting whole processing units within a folder, a parallelization processing unit, or a parallelized task processing unit, references from inside the pasted block to outside the block become #ERR.



# 6

## Performing Measurement and Adjustment

This section describes the settings that are related to the system environment of the Controller.

<b>6-1</b>	<b>Executing Test Measurements</b>	<b>6-3</b>
<b>6-2</b>	<b>Key Points for Adjustment</b>	<b>6-5</b>
6-2-1	Stabilizing Measurements	6-5
6-2-2	Shortening Processing Time	6-7
<b>6-3</b>	<b>Useful Functions for Operation</b>	<b>6-8</b>
6-3-1	Logging Measurement Values and Measurement Images [Data Logging/Image Logging]	6-8
6-3-2	Saving Data to an External Device [FTP/Network Drive]	6-24
<b>6-4</b>	<b>Useful Functions for Operation</b>	<b>6-27</b>
6-4-1	Remeasuring Saved Images [Remeasurement]	6-27
6-4-2	Improving Adjustment Efficiency [Judgement Result Monitoring]	6-28
<b>6-5</b>	<b>Analyzing Inspection and Measurement Results [NG Analyzer]</b>	<b>6-29</b>
6-5-1	Layout of NG Analyzer Window	6-30
6-5-2	Using Method of NG Analyzer	6-33
6-5-3	Saving Measurement Values	6-35
6-5-4	Changing Judgement Conditions without Stopping Measurement [Simplified Non-stop Adjustment]	6-35
6-5-5	Changing Regions as a Batch [Shift area]	6-37
<b>6-6</b>	<b>Updating the Reference Position Data for a Unit in the Measurement Flow [Update Standard Position Tool]</b>	<b>6-38</b>
6-6-1	Monitoring Measurement Value Trends [Trend monitor]	6-39
6-6-2	Clearing Measurement Results [Measurement Clear]	6-41
6-6-3	Clearing Saved Images [Logging Image Clear]	6-41
<b>6-7</b>	<b>Managing Images used for Model Registration and Reference [Registered Image Manager]</b>	<b>6-42</b>
6-7-1	Specifying the Destination to Save	6-42
6-7-2	Registering Images	6-44
6-7-3	Renaming Image Names	6-45
6-7-4	Deleting Images	6-46
6-7-5	Loading Images	6-46
<b>6-8</b>	<b>Verifying Calibration Results [Calibration Support Tool]</b>	<b>6-47</b>

6-8-1	Data Setting .....	6-47
-------	--------------------	------

## 6-1 Executing Test Measurements

Test whether the intended measurement processing can be performed with the current setting contents. Look at test results and adjust the property settings of each processing unit.

Perform measurement according to the conditions set for the displayed scene.

- 1 In the Main Window (layout 0), click the [Camera image meas.] button in the Measurement Pane.
- 2 Set the following items as test conditions.

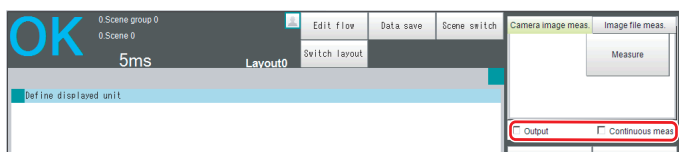

Parameter	Description
Output	Select this check box when the measurement results on the adjustment window are also to be output. Clear the checkmark when test measurement for the device is to be performed without results being output.
Continuous meas.	Select this check box when continuous measurement is to be performed. Click the [Measure] button to start continuous measurements.

- 3 Click the [Measure] button in the Measurement Pane.  
The measurement is performed.



### Additional Information

If continuous measurements are in progress, the [Stop continuous meas.] button will be displayed. To stop continuous measurements, click the [Stop continuous meas.] button.

- 4 Check the measurement results.
- 5 If necessary, adjust the setting values for each processing unit again.  
You can move to the property dialog box directly by clicking the button of any processing unit in the flow.

Property setting buttons

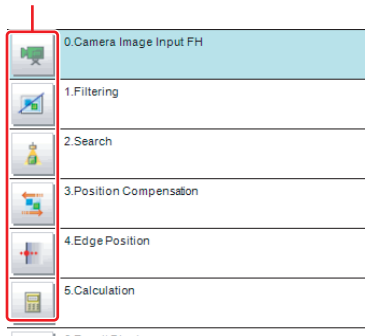



### **Additional Information**

---

Test images can be saved. This function is called logging. After setting conditions, the saved test images can be used in performing test measurements again.

Refer to *6-3-1 Logging Measurement Values and Measurement Images [Data Logging/Image Logging]* on page 6-8.

---



### **Important**

---

The processing time displayed in the Information Pane during continuous measurements executed via the test measurement settings includes the update time of the display, while that for continuous measurements executed by external commands does not, since measurement is higher prioritized in that case. Therefore, the processing time for continuous measurement executed via test measurement menu may be longer than that for continuous measurement executed by external commands. Measurement intervals and display update intervals should be evaluated in the actual configuration.

---

## 6-2 Key Points for Adjustment

---

This section describes key points for adjustment to improve measurement precision and shorten measurement time.

### 6-2-1 Stabilizing Measurements

This section describes key points for adjustment when measurements are not stable. There are two methods for improving measurement precision: Performing processing of images loaded from the Camera (filtering) or adjusting settings and parameters.

#### Adjusting Parameters of Each Processing Item

---





Adjustment to improve precision and stability depends on the processing item.

Refer to *Key Points for Adjustment* for individual processing items in the *Vision System FH/FHV/FZ5 Series Processing Item Function Reference Manual* (Cat. No. Z341).

## Processing Images (Filtering)

There are cases in which high-precision measurement is impossible, such as when using images loaded from the Camera that have noise, irregularities, or low contrast or when the background has patterns during defect measurement.

Refer to *Filtering* in the *Vision System FH/FHV/FZ5 Series Processing Item Function Reference Manual* (Cat. No. Z341).

<p><b>When measurement images have irregularities (searching and location positioning are not stable)</b></p> <p>The Smoothing (Strong and Weak) and Median filter items are both effective.</p> <ul style="list-style-type: none"> <li>• Smoothing (Strong and Weak) This processing changes the shade of images so that irregularities are not as easily seen.</li> </ul> <p><b>Weak Smoothing</b></p> <p>Before Processing      After Processing</p>  <ul style="list-style-type: none"> <li>• Median In comparison with smoothing, the Median filter item allows for irregularities to be hidden without having to shade the edges of images.</li> </ul>	<p><b>Measurement Images That Contain Noise The Dilate and Erosion filtering items are both effective.</b></p> <p><b>The Dilate and Erosion filtering items are both effective.</b></p> <ul style="list-style-type: none"> <li>• Dilate When there is dark noise in an image, bright areas are enlarged to eliminate dark noise.</li> <li>• Erosion When there is bright noise in an image, bright areas are contracted to eliminate bright noise.</li> </ul> <p><b>Erosion</b></p> <p>Before Processing      After Processing</p> 
<p><b>Measurement Images with Low Contrast (Defect Inspection Is Unstable)</b></p> <p>The Extract Vertical Edges, Extract Horizontal Edges, and Extract Edges filtering items are effective.</p> <ul style="list-style-type: none"> <li>• Extract Vertical Edges This extracts the vertical edges of an image.</li> </ul> <p><b>Extract Vertical Edges</b></p> <p>Before Processing      After Processing</p>  <ul style="list-style-type: none"> <li>• Extract Horizontal Edges This extracts the horizontal edges of an image.</li> <li>• Edge Extraction This extracts all edges of an image.</li> </ul>	<p><b>When Unidentifiable Shapes Are Present</b></p> <p>The Edge Extraction filtering item is effective.</p> <ul style="list-style-type: none"> <li>• Edge Extraction This is used to make the profile clearer and the shape more identifiable.</li> </ul> <p><b>Edge Extraction</b></p> <p>Before Processing      After Processing</p> 



## 6-2-2 Shortening Processing Time

### Checking Processing Times for Each Processing Unit

Find out which processing units are taking the most time and adjust the parameters of those processing items.

- 1 Insert the Elapsed Time processing item after the processing unit for which time is to be measured.

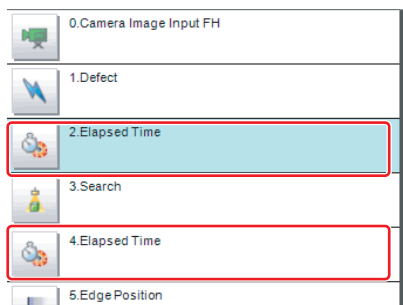

- 2 Execute the measurement.
- 3 Click the Detail Result Area, and then click the Elapsed Time processing unit where time is to be checked.

The elapsed time from the top of the flow to the relevant processing unit is displayed.

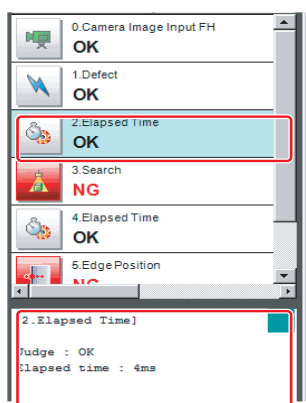

- 4 Adjust the parameters of the processing units that are taking time.  
Refer to *Points for Adjustment* for individual processing items in the *Vision System FH/FHV/FZ5 Series Processing Item Function Reference Manual* (Cat. No. Z341) for details on adjustment parameters.

### Shortening the Processing Time for the Overall Measurement Flow

You can use parallel processing to shorten the processing time.

Parallel processing reduces the processing time of the overall measurement flow. It uses a multi-core CPU to process different parts of the measurement flow in parallel at the same time.

Refer to *4-4-2 Parallel Processing* on page 4-29.

## 6-3 Useful Functions for Operation

### 6-3-1 Logging Measurement Values and Measurement Images [Data Logging/Image Logging]

#### What Is Logging?

Logging is used to save Camera input images or measurement results when executing measurements. Depending on what is being saved, there is image logging (camera input images) and data logging (measurement results)

File type and save method can be set in the Logging setting menu of System settings.

There are two logging functions, system logging and logging that is performed by the processing item.

#### ● Image Logging

- System Logging

To enable system logging, set the logging setting in the system settings.

The image logging process is executed after processing of the measurement flow is completed.

- Processing Item Logging

For those processing items that include logging function, Image Logging and Image Conversion Logging are two available logging functions.

To enable processing item logging, register the processing items in the measurement flow.

This logging function allows you to more flexible set the logging conditions than system logging. If there is more than one Image Logging Unit in the measurement flow, image logging is performed based on the logging conditions for the most recently executed Image Logging Unit.

Refer to *Specifying Logging Conditions for Images* on page 6-21.

## ● Data Logging

### • System Logging

Data logging does not have a system logging function. Use a Data Logging/Result output (Message) processing item.

### • Processing Item Logging

For those Processing items that include logging function, Data Logging and Result output (Message) are available.

In the FHV series, only the result output (message) processing items can be used.

To enable processing item logging, register the processing items in the measurement flow.

If there is more than one data logging unit in the measurement flow, data logging is performed based on the logging conditions for the most recently executed data logging unit.



### Important

- If you use logging, the measurement processing time will take longer for the time required for the logging process. If you need to continuously execute measurements that include image logging, allow enough time between measurement triggers after the first trigger to allow time for image processing.  
Refer to *Calculating the Measuring Interval [Logging Priority Mode]* on page 6-20 for information on measuring the time for image logging processing.
- Processing item image logging and system image logging cannot be used at the same time. If you prefer to use the Image Logging processing item, click [System Settings] – [Other] – [Logging setting] – [Image logging], and then select [None].
- If you prefer to use the Data Logging processing item, click [System settings] - [Other] - [Logging setting] - [Data Logging] and configure the logging conditions.

This section describes system logging in detail.

Refer to the *Vision System FH/FHV/FZ5 Series Processing Item Function Reference Manual* (Cat. No. Z341) for information on processing item logging.

The processing items that can be logged are described below.

## ● Image Conversion Logging

This logging saves Camera images.

Image conversion logging allows you to draw a rectangle around a portion of the image to save. You can also specify the format of the saved image (BMP or JPG).

## ● Data Logging, Result output (Message)

Measurement data is saved.

## System Logging

There are 2 different logging methods.

- Logging Images That Are Currently Displayed  
Refer to *Logging Current Image [Save Last Logging Image]* on page 6-10.
- Automatically Logging Images During Measurements  
Refer to *Setting Logging Conditions [Logging Setting]* on page 6-11.

Images and measurement data can be saved in external storage, which makes them useful for the following kinds of adjustment.

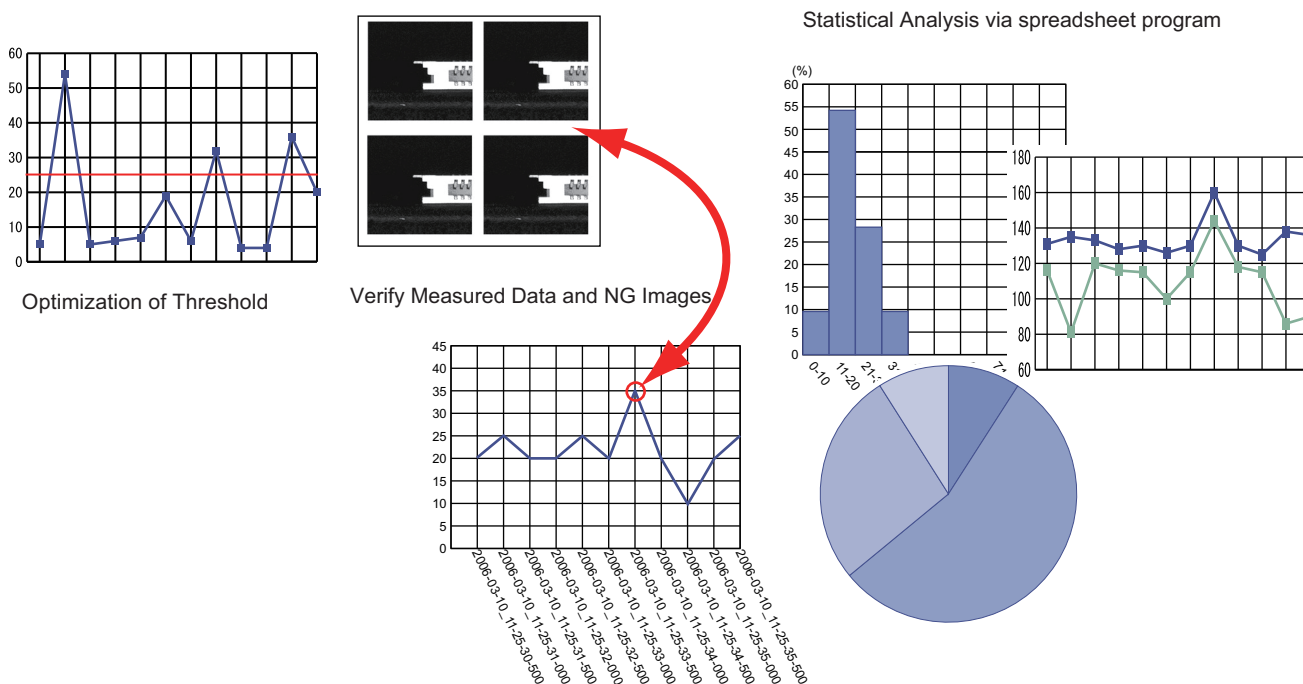

## Logging Current Image [Save Last Logging Image]

You can setup logging timing, save destination, save file format and logging method.

- 1** In the Main Window, select [Save last logging image] from the [Function] menu.  
The File Explorer is displayed.
- 2** Set the logged image save destination.  
Specify the image file save destination (RAM disk or external storage).

- 3** Edit the file name as required.

- 4** Click [OK].  
After the logging operation is complete, the Save Last Logging Image Dialog Box closes.

## Setting Logging Conditions [Logging Setting]

Set the logging time, save destination, file type and logging method.

- 1 In the Main Window, select [Tool] – [System settings] – [Other] – [Logging setting] menu. The [Logging settings] dialog box is displayed.

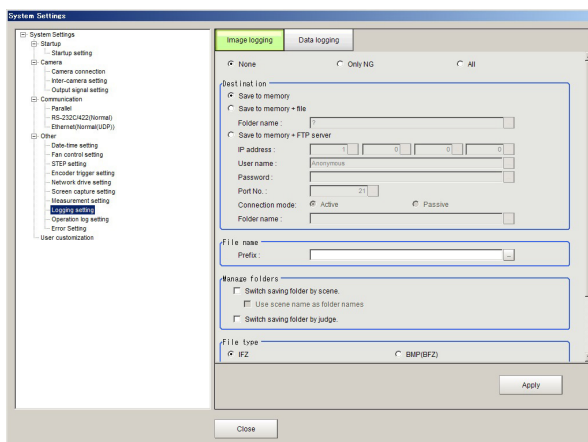

- 2 Click the [Image logging] tab.
- 3 Set the image logging conditions.



Parameter	Set value [Factory default]	Description
Image logging	[None]	No images are saved. When logging images with the processing item [Image Logging], select [None].
	Only NG	Only images with an overall judgement of NG are saved.
	All	All measured images are saved. Some images may not be saved if [Measurement] is set in [Logging priority] in step 4.

#### 4 Set the logged image save destination.

Parameter	Set value [Factory default]	Description
Destination	[Save to memory]	Saves data to the Controller memory (RAM).
	Save to memory + file	Images that are saved to the Controller memory (RAM) are saved as files to external storage or to the RAM disk in the Controller.
	[Save to memory + FTP Server]	Images that are saved to the Controller memory (RAM) are saved as files to the FTP server.



#### Important

- Logging images saved in the Controller memory are overwritten starting with the oldest image if the upper limit for the number of save images is exceeded. Refer to *A-7 About Number of Logging Images* on page A-23.
- The data saved in the Controller memory or RAM disk is deleted when the Controller is restarted.
- If an external storage is specified as the save destination, the processing time may be longer or may fluctuate. Be sure to check functionality thoroughly before starting operation.
- If images and data are logged to a network drive, the use of the multi-input function and other heavy measurement loads on the Controller may slow down communications and cause logging errors.  
In this case, set the measurement Takt time so that there is some leeway.
- [Save to memory + FTP Server] can be used with FH/FHV/FZ5-800/1100/1200 series only. It can not be used with FZ5-600/FZ5-L series.
- There are below limitations for [Save to memory + FTP Server] function.
  - Connection via a proxy server cannot be made.
  - Some servers will not generate logging errors even if save memory capacity is insufficient.
- In the case of where a recognition delay of external storage has occurred at start-up of the Sensor Controller depending on types or number of connections of external storage, logging may fail in a measurement executed just after start-up of the Sensor Controller.  
Use the Device Information Storage Tool to execute logging to external storage.  
Refer to *3-6-2 Device Information Storage Tool* on page 3-35.
- In the case where a connection with an FTP server needs longer time at startup of the Sensor Controller depending on types of FTP server, logging may fail just after start-up of the Sensor Controller.  
In that case, start a measurement after sufficient time passed after the Sensor Controller start-up according to your usage environment.

**Additional Information**

In order to perform logging quickly, image files are first saved in the Controller memory (RAM). The Controller memory (RAM) for saving images is a ring memory.

Refer to *A-7 About Number of Logging Images* on page A-23.

If power of the Controller is turned OFF or it is restarted, the data saved in the Controller memory or RAM Disk will be cleared.

Select [Save to memory + file] or [Save to memory + FTP Server] to save them in external storage.

When [Save to memory + file] in [Destination] is selected, set the destination and file names.

Parameter	Set value [Factory default]	Description
Folder name	<ul style="list-style-type: none"> <li>• [RAM Disk]</li> <li>• Drive name of external storage device</li> </ul>	Specify the image file save destination (RAM disk or external storage). Logged images are saved in the specified save destination folder. (Maximum number of characters: 128 single-byte characters)

If you select [Save to memory + FTP Server] as a [Destination], configure the setting items below.

Setting item	Set value [Factory default]	Description
IP address	a.b.c.d a: 1 to 223 b: 0 to 255 c: 0 to 255 d: 0 to 255 [1.0.0.0]	Specify the IP address of the destination FTP server. Connection via a proxy server cannot be made.
User name	[Anonymous]	Specify the user name which is used for a connection with the destination FTP server. Use only single-byte alphanumeric characters and numbers.
Password	---	Enter the password for a connection with the destination FTP server.
Port number	[21]	Enter the port number for a connection with the destination FTP server.
Connection method	<ul style="list-style-type: none"> <li>• [Active]</li> <li>• Passive</li> </ul>	Select the FTP connection method.
Folder name	---	Specify the destination directory of the FTP server. Use the relative pathname of the destination directory. Use only single-byte alphanumeric characters and numbers.

## 5 Specify the prefix of the image logging file.

Setting item	Set value [Factory default]	Description
Prefix	---	Set the prefix for the saved file name. (Maximum number of characters: 32 single-byte characters) The set character string is added at the beginning of the name of the save file. Use only single-byte alphanumeric characters and numbers. If a prefix contains a non-supported character, a logging error is generated when logging is executed.

## 6 When you use the function to switch the saving folder, set the switching conditions.

Setting item	Set value [Factory default]	Description
Switch saving folder by scene	<ul style="list-style-type: none"> <li>• Checked</li> <li>• [Unchecked]</li> </ul>	If this is checked, folders that correspond to scene numbers are automatically created and image files are divided by scene and saved.
Use scene name as folder names	<ul style="list-style-type: none"> <li>• Checked</li> <li>• [Unchecked]</li> </ul>	<p>If this is checked, folders to which image files are allocated are named using the scene names and scene group names at the time of measurement execution.</p> <p>If a scene name contains a character not supported for folder names, a logging error is generated when logging is executed.</p> <p>The following symbols can not be used in the file or folder names.</p> <p>¥ / : ; * ? " &lt; &gt;  </p> <p>If these symbols are used, a logging error is generated when logging is executed.</p>
Switch saving folder by judge	<ul style="list-style-type: none"> <li>• Checked</li> <li>• [Unchecked]</li> </ul>	If this is checked, OK/NG folders are automatically created and image files are divided by the overall judgment and saved.

- [Save to Memory + File] Setting Example and Save Destination

Setting example	Destination
<ul style="list-style-type: none"> <li>• Folder name: USB disk</li> <li>• Prefix: image_</li> <li>• [Switch saving folder by scene]: Selected</li> <li>• [Switch saving folder by judge.]: Selected</li> </ul>	<p>The settings in the example on the left are applied as shown below.</p> <ul style="list-style-type: none"> <li>• OK image save destination:            \USBDisk\S000-000\OK\image_(Measurement ID).IFZt</li> <li>• NG image save destination:            \USBDisk\S000-002\NG\image_(Measurement ID).IFZ</li> </ul>

- [Save to Memory + FTP Server] Setting Example and Save Destination

Setting example	Destination
<ul style="list-style-type: none"> <li>• IP address: 10.5.6.100</li> <li>• User name: OMRON</li> <li>• Password: abc</li> <li>• Port number.: 21</li> <li>• Connection method: Active</li> <li>• Folder name: Logging</li> <li>• Prefix: image_</li> <li>• [Switch saving folder by scene]: Selected</li> <li>• [Switch saving folder by judge]: Not selected</li> </ul>	<p>With left sample settings, the file will be saved as below.</p> <ul style="list-style-type: none"> <li>• When the current directory which FTP server specifies is "C:\Data\RAMDisk".            C:\Data\RamDisk\Logging\S000-000\image_(Measurement ID).ifz)</li> </ul>





### Additional Information

If logging errors occur, please check the following.

- Is the LAN cable connected properly?
- Are the destination server settings in system settings correctly set?
- Did you use any character other than single-byte alphanumeric characters for the file names or folder names?
- Did you use the following symbols as the file or folder names? ¥ / : , ; \* ? " < > |

Measurement ID: measurement time YYYY-MM-DD\_HH-MM-SS-XXXX

(YYYY: Calendar, MM: Month, DD: Day, HH: Hour, MM: Minute, SS: Second, XXXX: Millisecond and Line number)

Example

Measurement time: 11:10:25.500 AM, December 24, 2007 and Line 0, the measurement ID is "2007-12-24\_11-10-25-5000".

Since the file name of the logging image also includes the same measurement ID, confirmation of the measurement data and image data can be performed with the measurement ID.

## 7 Select the file type.

Set the file type to save image files.

Refer to *A-6 Image file* on page A-20.

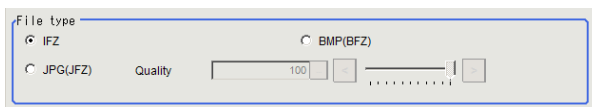

Setting item	Set value [Factory default]	Description
File type	<ul style="list-style-type: none"> <li>• [IFZ]</li> <li>• BMP(BFZ)</li> <li>• JPG(JFZ)</li> </ul>	Select the file type to save images for Logging. <ul style="list-style-type: none"> <li>• IFZ: Save as an OMRON image logging file format for use with FH/FZ series, or FQ series.</li> <li>• BMP (BFZ): Save as a container format image logging file that includes BMP format image files.</li> <li>• JPG (JFZ): Jpeg format image files are organized in folders when saved as a logging image file format.</li> </ul>
Quality	0 to [100]	Image quality settings for saving as JPG (JFZ).



### Important

- If you save as BMP(BFZ)format /JPG(JFZ) format, the handling for the area outside the image differs from the IFZ file format and emphasizes ease of display. If you want to perfectly reproduce the measurement processing, including error processing on the outside part of the image, save it as IFZ file format.
- Do not change the name of any BMP/Jpeg included in the BMP(BFZ) file/JPG(JFZ) file type. Measurement may fail on this file type when loaded.
- If there are camera image input numbers for the BMP format files included in the BMP(BFZ)/JPG(JFZ) file type that are out of sequence, measurement will not be done on images after the first out of sequence number.
- JPG(JFZ) format can be read and measured with sensor controller software version 5.71 or later. Since it is an irreversible compression image format, the measurement result differs from IFZ format, or BMP(BFZ) format.



**Additional Information**

Differences among IFZ, BMP (BFZ) and JPG(JFZ) are as follows. Select the type depending on the intended use.

**1. File type**

- IFZ is an OMRON proprietary image file type. In order to confirm images in this file type, a Sensor Controller, or custom tools are necessary.
- BMP(BFZ)/JPG(JFZ) is a standard bitmap/Jpeg format image file type. Images in this file type can be confirmed with standard PC desktop image tools and without the need for any custom tools.

**2. File size**

- BMP(BFZ) is triple in size than IFZ file type when you save color images.
- JPG(JFZ) format file size varies depending on image quality.
- Conversion time differs when converts IFZ to BMP(BFZ)/JPG(JFZ) during loading/writing the BMP(BFZ)/JPG(JFZ) files or due to savable images depending on differ of file size.

**3. Compatibility**

- The IFZ file type in Sensor Controller software version 5.30 or earlier can be loaded and measured and recognition of multiple cameras is also enabled.
- The BMP(BFZ) file type in Sensor Controller software version 5.30 or earlier can be loaded and measured, however it will be processed the same as one BMP image due to no multiple camera information.

**8** Select the save method for Multiple image logging.

Select the save method when you use multiple camera image inputs in the measuring flow.

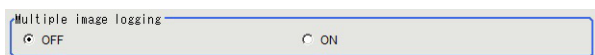

Setting item	Set value [Factory default]	Description
Multiple image logging	<ul style="list-style-type: none"> <li>• [OFF]</li> <li>• ON</li> </ul>	Select the save method when you use multiple camera image inputs in the measuring flow. OFF: Save only latest image of camera image input in measurement flow. ON: Save transported input images of all camera image input in the measurement flow.

Describe the example when two cameras connected and Camera image input function is executed three times.

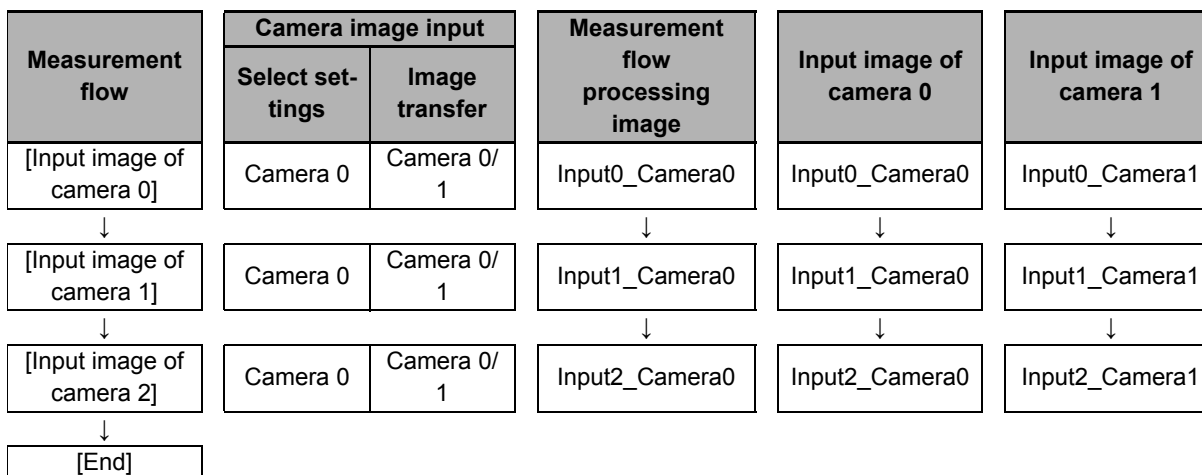

- **Multiple image logging is [OFF]**

- Saves the latest input image of camera. Specifically, two images, Input2\_Camera0 and Input2\_Camera1, are saved.

- **Multiple image logging is [ON]**

- Saves all of the transferred input images at the camera input. Specifically, six images,
- Saves the latest input image of camera. Specifically, two images, Input2\_Camera0 and Input2\_Camera1, are saved.



### Important

Multiple image logging is [ON]

- Processing time will be long when parallel is [OFF] because all of the transferred images are saved.
- Some latest images exceeds the memory size will be deleted because all of the transferred images are temporarily saved to the Sensor Controller.

## 9 Set the image logging priority conditions.

When the measurement takt time is short, a time lag may occur in writing from the Controller memory (RAM) to the RAM disk in the Controller and a temporary lack of available space in the Controller memory may occur. Select whether logging or measurement has priority at these times.

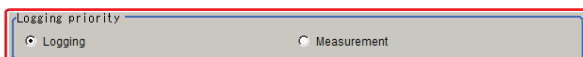

Parameter	Set value [Factory default]	Description
Logging priority	[Logging]	Image logging is prioritized over the following measurement. If overwriting of measurement images as logging images in the Controller memory (RAM) is not available, measurement is continued until it becomes available. When overwriting becomes available, the next measurement trigger can be accepted.
	Measurement	Starting measurement is prioritized over image logging. If overwriting of measurement images as logging images in the Controller memory (RAM) is not available, the measurement image is discarded, and the next measurement trigger is accepted.



### Additional Information

To save all images that are logged, set the operation mode of the Sensor Controller to [Standard] (Operation Mode) and the Logging setting (logging condition) to [Logging]. At the same time, select [Tool] – [System Settings] – [Startup], and turn OFF [Parallel execute] under the operation mode In the startup settings.

**10** Click [Data Logging].

The data format is set with the Data Logging processing item.

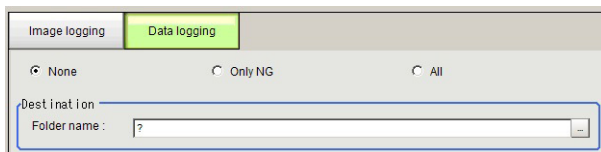

Parameter	Set value [Factory default]	Description
Data logging	[None]	Measurement data is not saved.
	Only NG	Measurement data is saved when an NG error occurs in a unit before a [Data Logging] unit. If an NG error occurs after the [Data Logging] processing unit, data logging is not performed.
	All	All measurement data is saved.

**11** Set the logged data save destination.

Parameter	Set value [Factory default]	Description
Folder name	<ul style="list-style-type: none"> <li>• [RAM Disk]</li> <li>• USBDisk</li> </ul>	The data is saved in the specified destination folder (RAM disk or USB disk). Set the file name with the [Data Logging] processing unit. (Maximum number of characters: 128 single-byte characters)

**12** Click [Apply].**Important**

- The data saved in the Controller memory or RAM disk is deleted when the Controller is restarted.
- If external storage is specified as the save destination, the processing time may be longer or may fluctuate. Be sure to check functionality thoroughly before starting operation.
- If images and data are logged to a network drive, the use of the multi-input function and other heavy measurement loads on the Controller may slow down communications and cause logging errors. In this case, set the measurement takt time so that there is some leeway.



### Additional Information

#### Image Logging

- When the number of files in the save destination folder increases, the time needed to save images increases.
- If you specify Disable in [Camera Image Input], its camera image will not be saved.

#### Number of Images That Can Be Saved

- This will depend on the size and resolution of the images and the number of Cameras connected.
- The number of images that can be saved on the RAM disk in the Controller or a external storage depends on available space.
  - If the RAM disk is selected, the memory available in the RAM disk
  - If external storage is selected, it depends on the external storage capacity.
- When you use the external storage device, some limitations may be required due to the combination of file format and Sensor Controller model.

Sensor Controller Model	File Format		
	FAT16	FAT32	NTFS
FZ5-L series FZ5-600 series	<ul style="list-style-type: none"> <li>• When you save the Image file to the immediately below root file, the number of the Image files can be saved is around 126.</li> <li>• When you save the Image file to one folder, the number of the Image files can be saved is 999.*1</li> </ul>	<ul style="list-style-type: none"> <li>• When you save the Image file to one folder, the number of image files can be saved is 999.*1</li> <li>• The maximum number of folders which can be created is 999.*1</li> </ul>	1NTFS is not supported in FZ5-L/FZ5-600 series Sensor Controller.
FH series FZ5-800/1100/ 1200 series	<ul style="list-style-type: none"> <li>• When you save the Image file to the immediately below root file, the number of the Image files can be saved is around 126.</li> <li>• When you save the Image file to one folder, the number of the Image files can be saved is 16000.</li> </ul>	<ul style="list-style-type: none"> <li>• The total number of the Image file can be saved to the immediately below root file or to one folder is around 16000.</li> </ul>	No limitation of file format.

\*1. This limitation will be initialized at the restarting of the Sensor Controller.

#### Loading Data to a Computer

- Default settings are set so that logging data is saved in the RAM disk in the Controller. When logging data is loaded to a computer, set [external storage] as the save destination. Logging data is first saved to the RAM disk in the Controller. It can then be copied from the RAM disk and saved to the [external storage] using [Copy files] in [Save to file].

## Calculating the Measuring Interval [Logging Priority Mode]

If the [Logging priority] is set to [Logging] (default), all target images are measured and logged. This may extend the processing time by the time that is required to generate the image files.

The method that is used to calculate the measurement interval that allows logging without affecting the processing time is described below.

### ● Measurement Interval Conditions

The measurement interval must satisfy the following condition.

$$\text{Processing time} + \text{Image logging time} < \text{Measurement interval}$$

- Processing time: The time that is displayed in the upper left corner.
- Image logging time: The time that is required to generate and save a single image file.

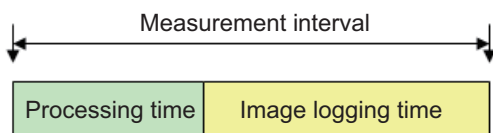

- Example:  
If the processing time is 100 ms and the image logging time is 150 ms, set the measurement interval to at least 250 ms.



### Important

#### [Standard] is selected for Operation Mode.

In Standard (Operation) mode, images can be logged while measurement is in progress.

The measurement interval must satisfy the following condition.

$$\text{Image logging time} < \text{Measurement interval}$$

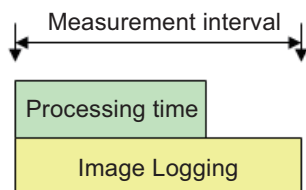

- Example:  
If the processing time is 100 ms and the image logging time is 150 ms, set the measurement interval to at least 150 ms.

## Specifying Logging Conditions for Images

If you need to specify conditions for logging images, you should use the processing item logging function.

For example, the system logging function logs all images if the overall judgement is NG or OK.

Processing item logging (image logging), logs images only when a condition is met.

The following examples illustrate how processing item logging can be used.

### ● Possible Saving Conditions

Images can be logged when measurement data or result data of a calculation falls within a specified range.

Example 1: Image logging is performed if the individual judgements of three measurement units U1, U3, and U5 are NG.

Example 2: Image logging is performed if the edge width for a measurement unit is below a set value.

### ● Destination of Images

This diagram shows the destination for saving if [Save to memory + file] is selected in the system image logging settings.

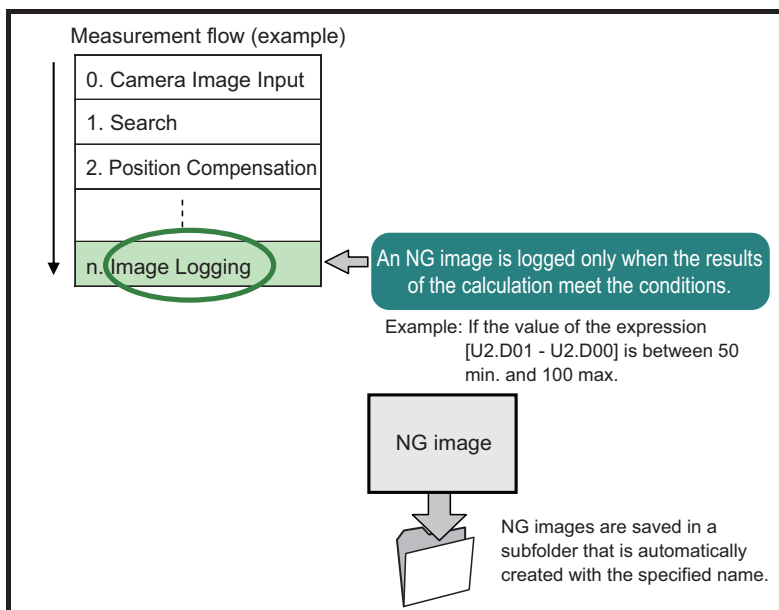

#### Important

If [Logging setting] is set to [Image logging], select [None] (default).



#### Additional Information

If you set more than one Image Logging processing unit in the measurement flow, the most recently executed image logging is enabled.

## Analyzing Logged Data

Acquired data is referred to and processed, and settings are analyzed.

### ● Checking Logged Data with a Computer

This section uses the example of saving logging data in USB memory.

- 1 Copy the logged data in the external storage to the computer.
- 2 Open the copied data in the folder using an application associated with the extension (.csv).  
This procedure describes an example for data displayed in spreadsheet program.
- 3 Process and analyze the data with a spreadsheet program.  
For example, the optimum threshold value can be calculated.

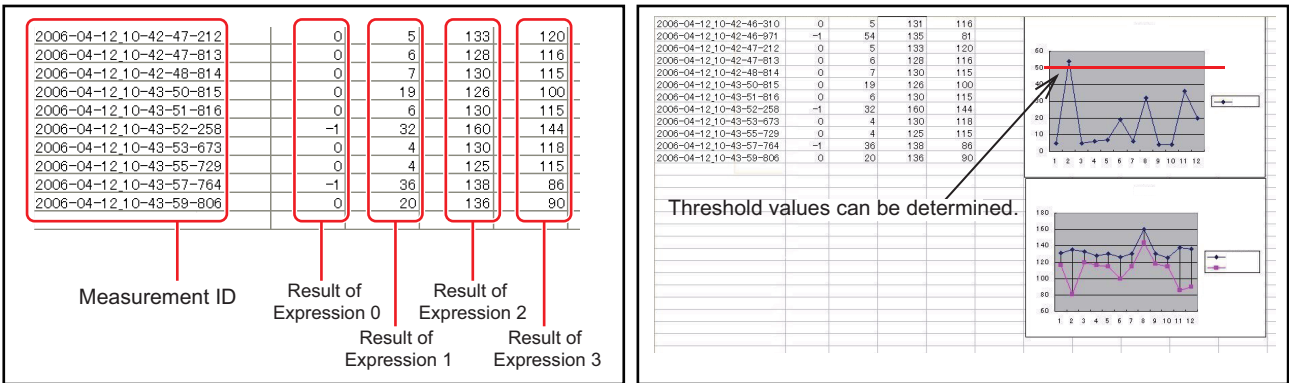

### ● Comparing Logged Data and Logged Images

Compare image and measurement data to confirm correctness and to make analyzing trends for when NG occurs easier.

The measurement data and image data stored with the logging functions are associated through measurement IDs based on the measurement date and time. One image data file contains the Camera image data of all the connected units.

In this way, measurement data can be made to always correspond with image data.

Verify data with the measurement ID.

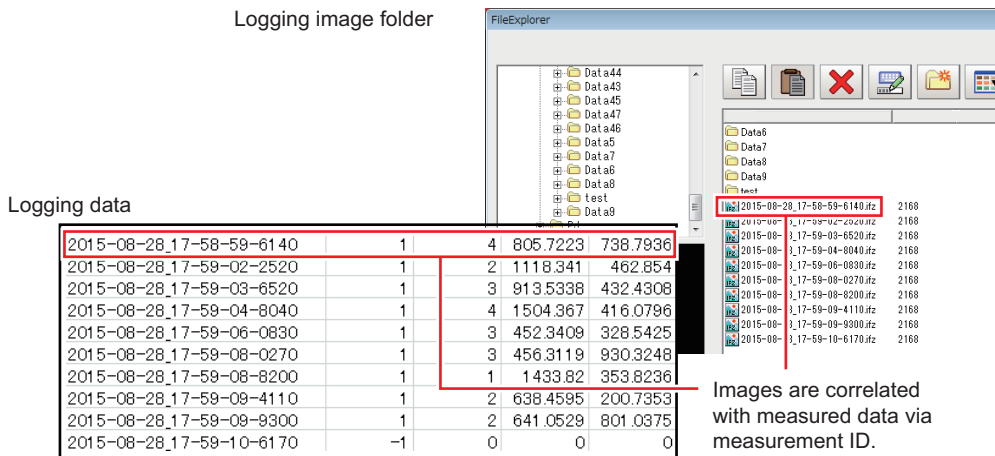





### Additional Information

---

Measurement ID

YYYY-MM-DD\_HH-MM-SS-XXXX.

YYYY: Year (4 digits)

MM: Month

DD: Date

HH: Hour

MM: Minute

SS: Second

XXXX: Millisecond

Example:

Measured time: 12/24/2007, 11:10:25.500:

Line: 0

Measurement ID: 2007-12-24\_11-10-25-5000

---

## 6-3-2 Saving Data to an External Device [FTP/Network Drive]

### Saving Logged Image Files to a Computer [FTP]

The FTP is useful when you need to save logged image files to a computer.

Example

When you want to move the logged image to your personal computer before FH Sensor Controller's RAMDisk or external storage is full:

Accessing to the FH Sensor Controller with FTP function, you can directly specify the file of RAMDisk or external storage from a browser and can move the file.

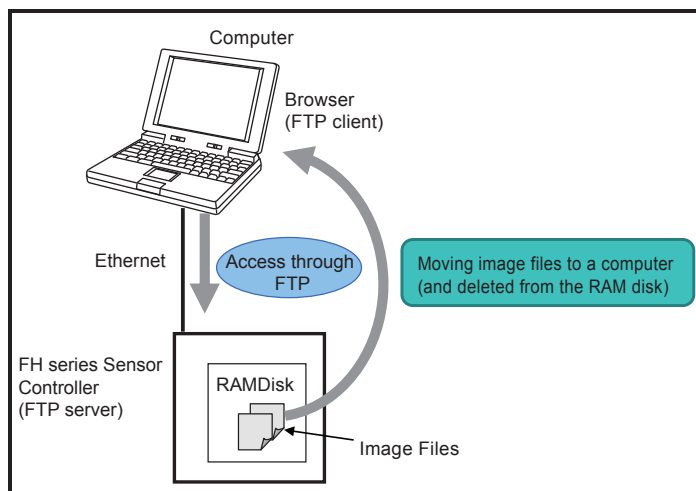

#### ● Operating Procedure

Use the following procedure to access the RAM disk in the FH series Sensor Controller.

- 1** Set up the computer and Controller for communications through Ethernet.
- 2** Start the Explorer on the computer.
- 3** In the address bar, type the IP address and destination and press the Enter Key.  
Example: [ftp://10.5.5.100/RAMDisk/]
- 4** The contents of the RAM disk are displayed as shown below.

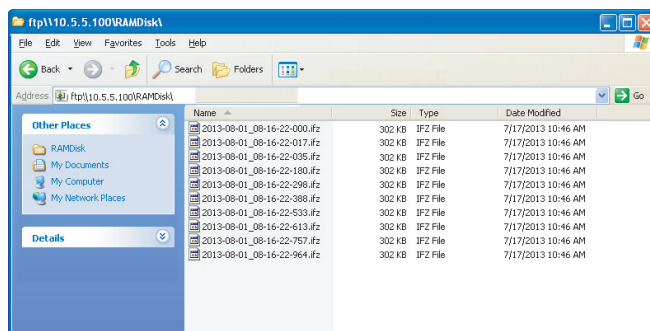

- 5** Drag and drop files as you would with normal file operations.



### Important

---

Use only single-byte alphanumeric characters for the file names of files to send and receive with the FTP.

- If account, or password is needed for FTP connection, set them as follows

Account: anonymous

Password: Blank or single-byte alphanumeric characters

- When you access to the external storage device except RAMDisk, refer to the following:
    - M:\ (SD memory card): SDDisk
    - E:\ (USB memory): USBDisk
    - E:\ (microSD card): SDDisk
    - F:\ (USB memory): USBDisk2
  - There is no FTP access to an external storage device, drive letter with G or higher.
- 



### Additional Information

---

- There are no limitations on when you can perform FTP file transfers.
  - Processing of FTP file transfers does not affect the transaction time. However, It does affect the load on the network.
-

## Saving Logged Data Directly to a Shared Folder on a Computer ([Network Drive Function])

The network drive function is useful when you need to log image data or measurement data directly to a computer that is connected by Ethernet.

You can specify the shared folder on a computer that is connected by Ethernet as the destination for logged images or logged data.

Direct reading and writing with the computer eliminates the need for reading and writing through external storage devices. At the same time, it also eliminates the need to stop measurements to insert or remove the external storage device.

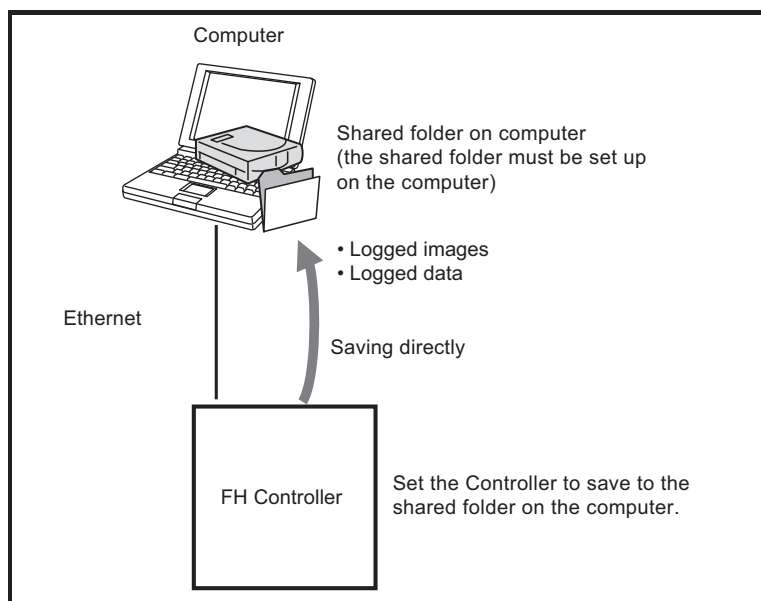

### ● Setting Up the Network Drive

Register the shared folder on a network drive with a shared name.

- 1** Select [Tool] menu – [System settings] – [Other] – [Network drive setting].
- 2** Select the shared name to be registered, and click [Edit].
- 3** Enter the information to be allocated to the network drive (shared name), such as the shared folder, user name, and password.
- 4** The shared folder on the connected computer will appear in the [Select file/folder] dialog box.

### ● Specifying a Network Drive as a Logging Destination

To import logging data to a computer, you specify a shared folder on the computer as the logged data destination.



#### Additional Information

The data saving time depends on the conditions of the network and the destination drive.

Be sure to check the operation thoroughly with the actual devices that will be used.

## 6-4 Useful Functions for Operation

### 6-4-1 Remeasuring Saved Images [Remeasurement]

Images at measurement including test measurement can be saved. Remeasurement can be performed with saved images after conditions are adjusted in order to check whether the adjustment is appropriate.

The logging function is used to save images.

Refer to 6-3-1 *Logging Measurement Values and Measurement Images [Data Logging/Image Logging]* on page 6-8.

Images that can be remeasured include images saved in the Controller and images saved in external storage.

- 1 Click the upper left corner of the Image Display Pane, set the [Image mode] to [Freeze], and then click the [OK] button.
- 2 In the Main Window (layout 0), click the [Image file meas.] button in the Measurement Pane.
- 3 Click the [Select image] button.

The [FileExplorer] dialog box is displayed.

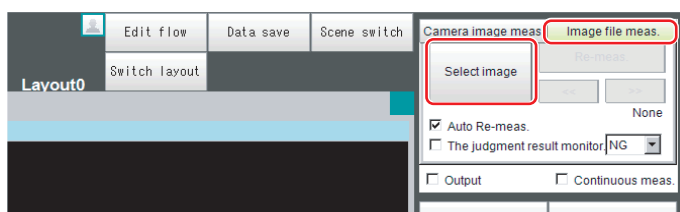

- 4 Select the file to display from the [FileExplorer] dialog box.
- 5 The selected image is displayed at the lower left of the [FileExplorer] dialog box.

When there are multiple camera images in a file, as for a logging image when multiple cameras are connected, use the [<<] and [>>] buttons to switch images.

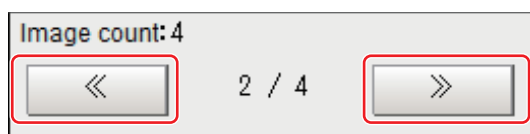

- 6 Click [OK].  
The path and file name of the image are displayed under [Select image].
- 7 In the Main Window (layout 0), click the [Re-meas.] button under [Image file meas.] .  
Measurement of the selected image is performed.



#### Additional Information

##### About Automatic Remeasurement

Displayed images can be automatically remeasured by selecting [Auto Re-meas.].



### Important

When remeasuring an image with the Controller, it is necessary to have a Camera connected that is appropriate to the image size. For example, if the image file for remeasurement contains 2-megapixel images and a 0.3-megapixel Camera is connected to the Controller or if a Camera is not connected, measurement will not be performed correctly due to a memory deficiency. Perform remeasurement after connecting a Camera appropriate to the image size.

## 6-4-2 Improving Adjustment Efficiency [Judgement Result Monitoring]

You can make adjustments more efficiently when you need to measure a large amount of image samples and classify or perform adjustments with each judgement.

Files in which there are both NG error files and OK files can be continuously remeasured automatically, with the system stopping at images with a specified condition (OK/NG) and moving those files.

- 1 In the Main Window (layout 0), click the [Image file meas.] button in the Measurement Pane.
- 2 Select [The judgment result monitor] and set the judgement conditions for identification.

If the specified judgement condition is achieved when continuous measurement is performed, measurement stops and the following message is displayed.

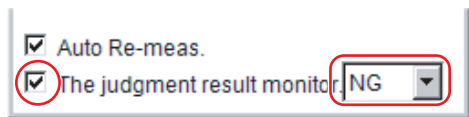

#### If OK Is Selected

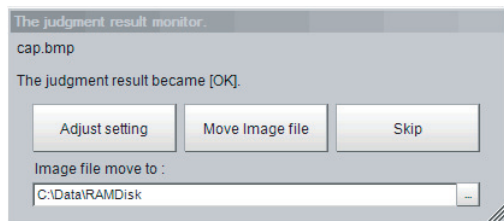

#### If NG Is Selected

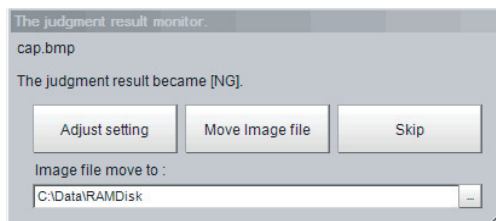

- 3 Select the processing for the measured image.
  - Adjusting Flow Settings  
Click the [Adjust setting] button.
  - Moving Images to Specified Folder  
Specify the folder to move the image file to.  
Click the [Move Image file] button.  
Click the [Skip] button to skip processing and remeasure the next image.

## 6-5 Analyzing Inspection and Measurement Results [NG Analyzer]

Start the NG analyzer by selecting [Tool] - [NG analyzer] from the Controller menu.

This tool, which analyzes setting flows, is used mainly in 2 ways.

- Adjustment of measurement set values during start-up  
Use sample workpiece images to analyze optimal set values for the processing flow.
- Analysis of NG causes during operation  
Use logged images to analyze NG causes.

The operation flow is as follows.

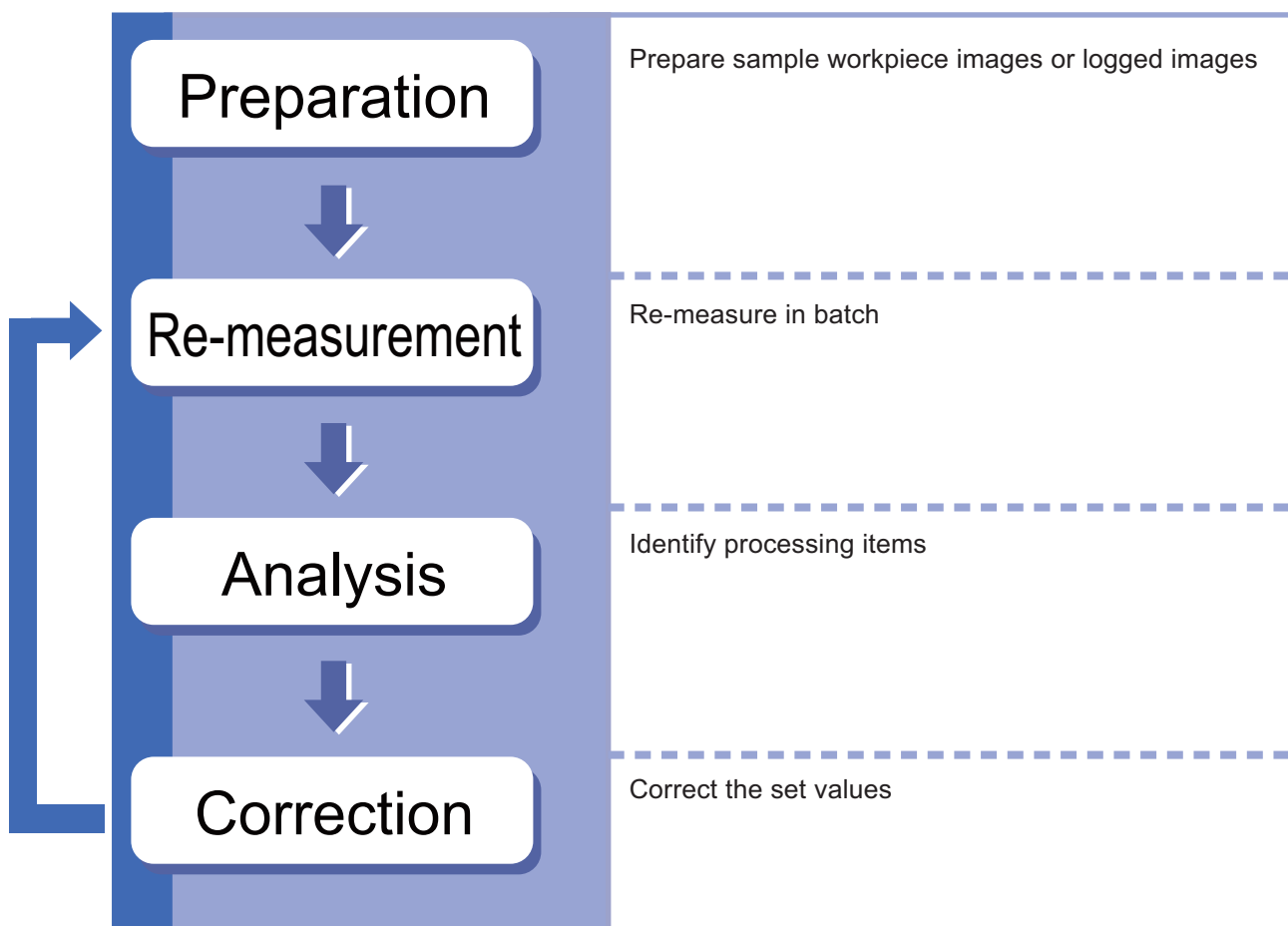

## 6-5-1 Layout of NG Analyzer Window

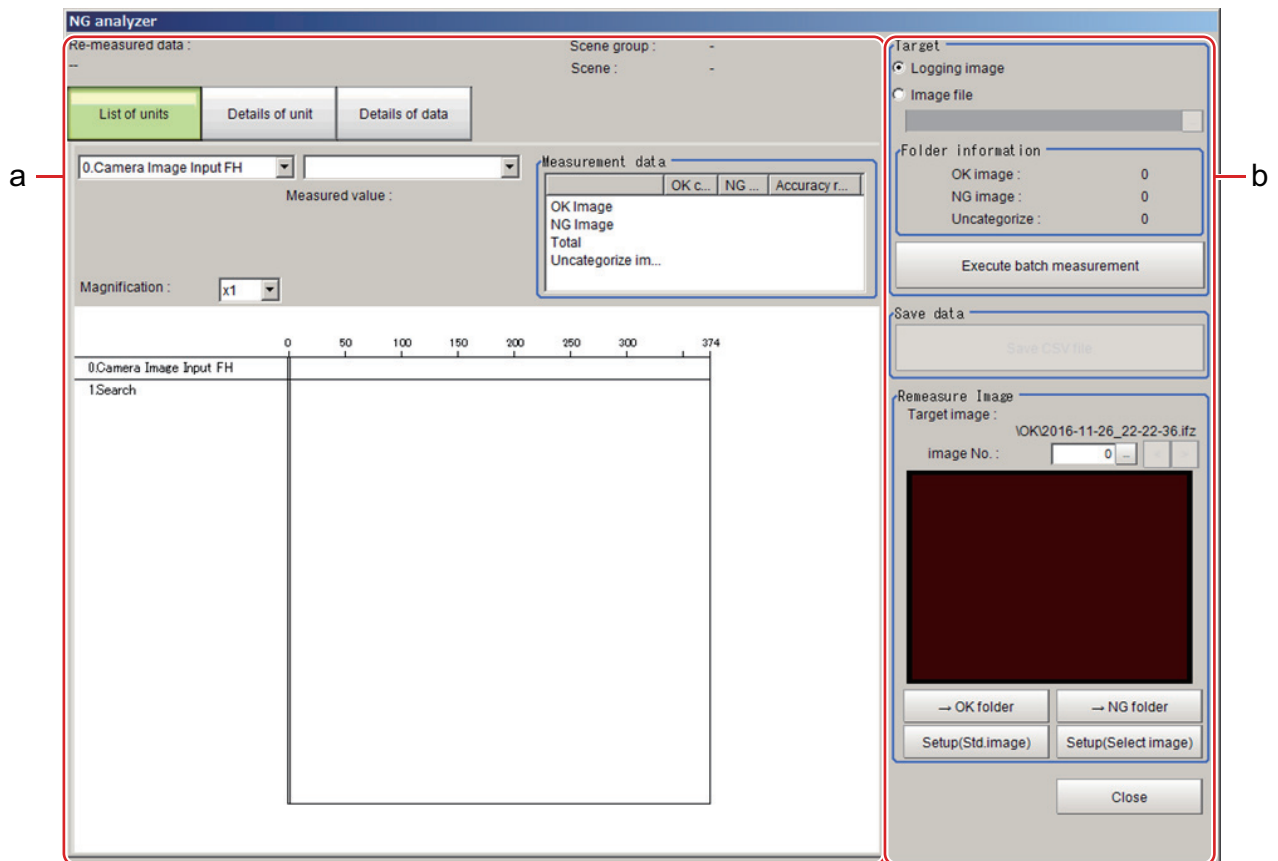

## a) Analysis result display area

## (1) Folder name/scene information to re-measure

Displays folder name, scene group number, and scene number for items for batch re-measurement.



## (2) Result display tab

Switches among three levels of details to display in the results display area.

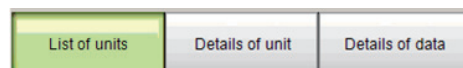

- List of units  
A list of units currently set is shown together with analysis results.
- Details of unit  
Detailed analysis results of each unit are shown.
- Details of data  
Detailed results of analysis data are shown.



(3) Display item selection

Selects items to display in the results display area.

You can switch between details that can be selected using the result display tab setting.

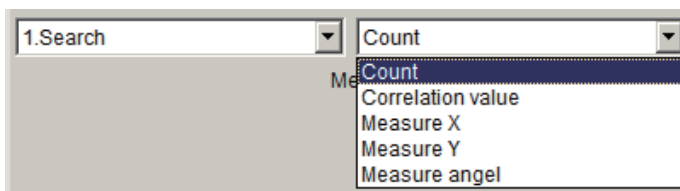

(4) Re-measurement results statistics

Displays the batch re-measurement results (statistics).

Measurement data			
	OK c...	NG ...	Accuracy r...
OK Image	0	14	0.00%
NG Image	0	18	100.00%
Total	0	32	56.25%
Uncategorize im...	0	0	--

(5) Display ratio

Specifies the display ratio for the results display area.

Magnification: 1 to 20

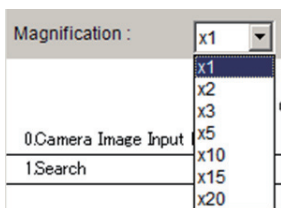

(6) Results display area

Switches to the display set in the result display tab.

You can also switch display details by clicking any portion within the area.

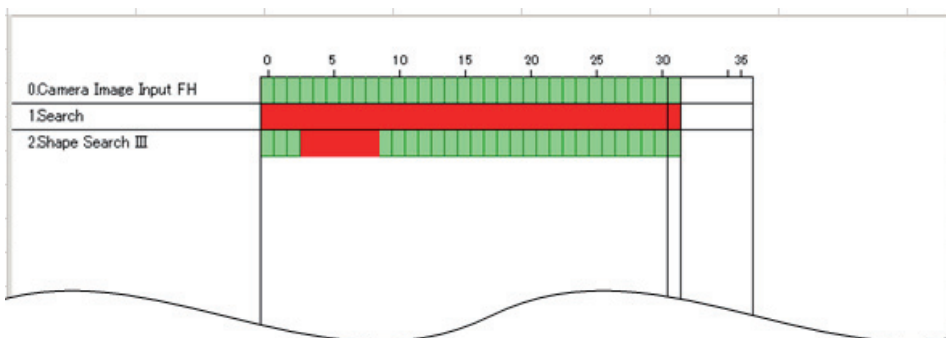

b) Control area

(1) Target area

Sets images to be measured: Logging image or Image file.

When selecting the “Image file”, the text box under the “Image file” becomes active.

Clicking [...] in the right side of the text box displays “Select folder” dialog below. Specify a folder containing images to re-measure.

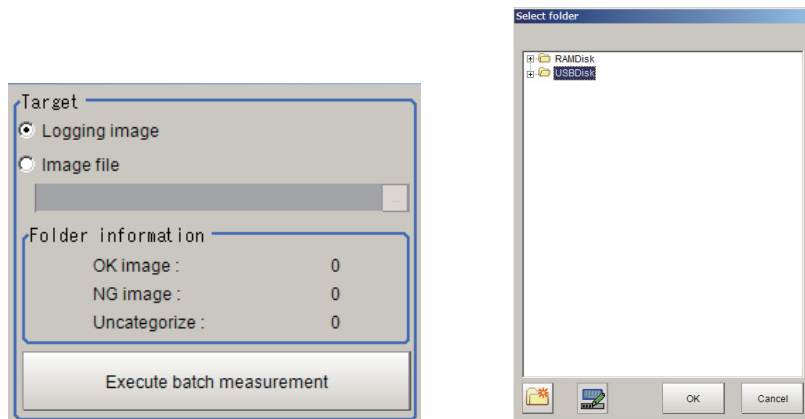

(2) Execute batch measurement button

When clicking the button, all of the specified target images are re-measured continuously.

(3) Save data

Outputs re-measured results to a selected folder as a CSV file.

When clicking the button, FileExplorer will be displayed. Select the folder and set the file name.

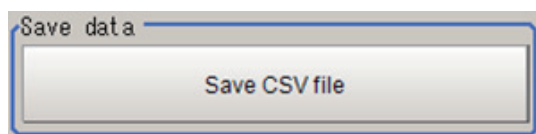

(4) Remeasure Image

Displays images for items selected in the results display area.

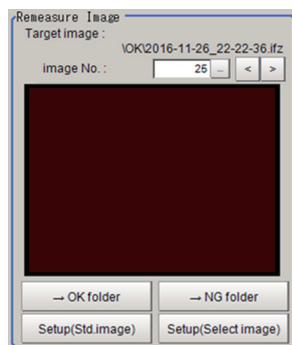

[<]/[>]: Switch images.

[→OK folder]: Update OK classification

[←NG folder]: Update NG classification

[Setup (Std. image)]: Adjust settings with the reference image.

[Setup (Select image)]: Adjust settings with a selected image.

## 6-5-2 Using Method of NG Analyzer



### Important

- Classify sample images beforehand into the OK folder containing images you want to judge OK or NG folder containing images you want to judge NG. (The applicable file types are "\*.IFZ", "\*.BYR", "\*.BMP" and "\*.BFZ".)
- Among images you want to judge as OK, adjust parameters of images judged as NG (misjudged images). Among images you want to judge as NG, adjust parameters of images judged as OK (misjudged images).
- Repeatedly adjust the parameters for the misjudged images until there is no misjudgment. Do not input external commands or STEP signals while the NG analyzer is running (excluding during non-stop adjustment).

**1** On the Main Window, select [Tool] menu - [NG analyzer].

The analyzer window is displayed.

**2** Select "Logging image" or "Image file" in the "Target" area.

When selecting "Image file", specify the upper rank folder containing the OK/NG folders by clicking [...]. The selected folder information will be displayed in the "Folder information" area.



### Additional Information

- Image files for the folder information displayed in the "Target" area are as follows.
  - Images directly below the selected folder: treated as Uncategorized.
  - Images directly below the selected folder\OK folder: treated as OK image.
  - Images directly below the selected folder\NG folder: treated as NG image.
- If [Logging image] is selected, all are treated as Uncategorized.

**3** Click [Execute batch measurement].

All images in the folder are measured in batch.

The measurement results are displayed. The results in the OK folder are shown first followed by that in the NG folder. Green indicates OK, while red indicates NG.

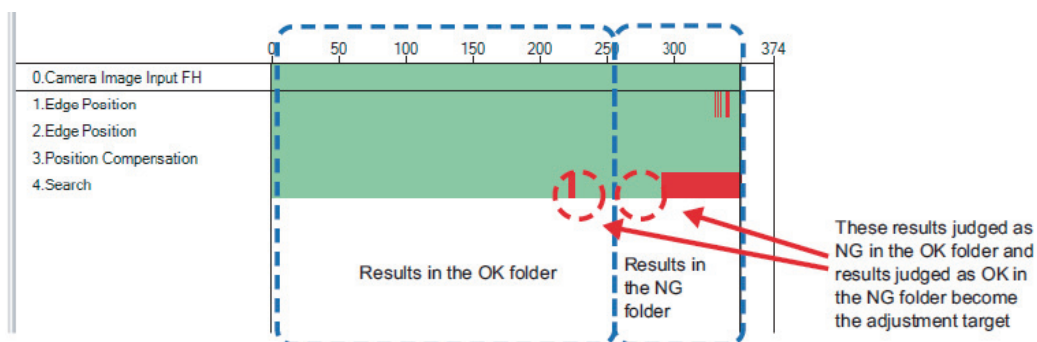

Adjust the setting values of each unit until no images are incorrectly judged.

**4** Select a processing unit to adjust by clicking the processing unit in the Results display area or [▼] in the Display item selection area.

In above example, [Search] becomes the adjustment target.

**5** The cause of NG is displayed. To check the details of values further, click [Details of data].

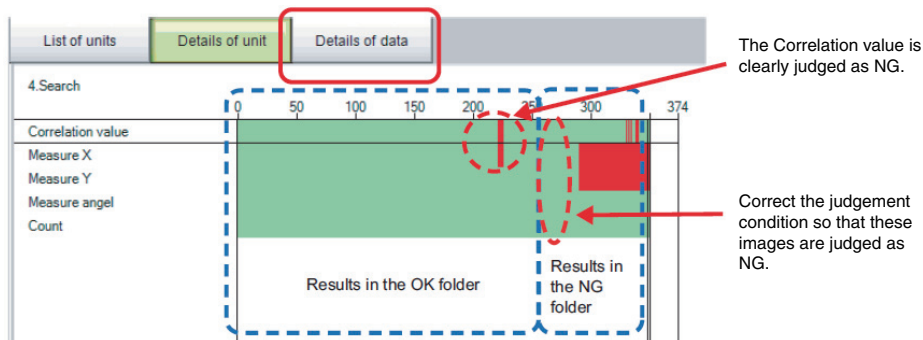

**6** Adjust processing units by referring to the displayed content.

In the following example, Correlation values are clearly lower on some images.

Based on the revealed cause of incorrect judgement, use the [Setup (Std. image)] or [Setup (Select image)] buttons to adjust the setting values of the processing unit.

For re-measurement results statistics, a standard deviation calculated with unbiased standard deviation is displayed.

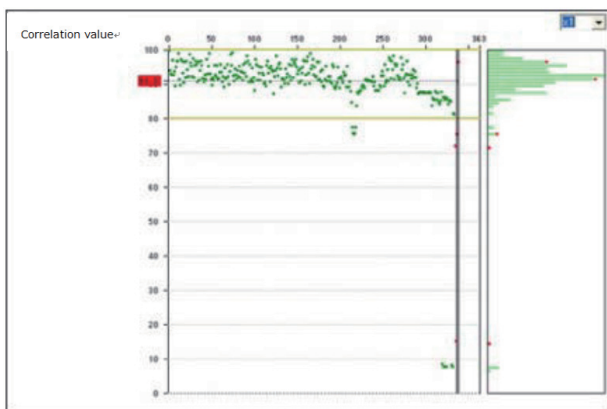

**7** Click a part of the displayed content that is a cause of incorrect judgement.

The “Remeasure Image” is switched to the incorrectly judged image.

Click [Setup (Std. image)] or [Setup (Select image)] to adjust settings of processing units.

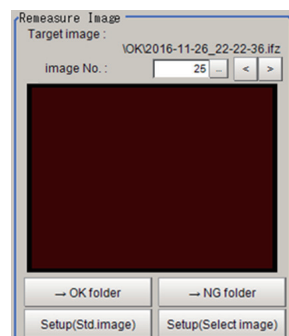

When clicking [Setup (Select image)], a property setting window for the selected processing unit is displayed. Adjust settings with the current image displayed in the Remeasure Image” area.

When performing the settings with the reference image previously used or any image, click [Setup (Std. image)]. After selecting an image file, a property setting window for the selected processing unit is displayed.

**8** Repeat steps 4 to 7 to correct the setting values corresponding to all causes of incorrect judgement.

**9** Click [Execute batch measurement] to confirm that no images are incorrectly judged.

If there are still incorrectly judged images, repeat the same procedure until a re-measurement finds no incorrectly judged image.



**Additional Information**

OK/NG judgments can be changed by using [→OK folder] and [←NG folder] buttons. In this case, the changes will not be reflected until re-measurement is performed.

### 6-5-3 Saving Measurement Values

After performing the batch measurement, the measurement values are saved.

- 1** Perform the steps 1 to 3 of 6-5-2 *Using Method of NG Analyzer* on page 6-33.
- 2** Click [Details of data] on the “Result display tab”.
- 3** Select a processing unit on the “Display item selection” to save the measurement value.
- 4** Click [Save CSV file] on the “Save data” area.  
FileExplorer is displayed. Specify the file name to save the data.  
The saved contents are the Scene group number, Scene number, remeasured image file name, processing units, selected measurement data, and contents in the “Measurement data” area.

### 6-5-4 Changing Judgement Conditions without Stopping Measurement [Simplified Non-stop Adjustment]

Using the simplified Non-stop Adjustment function makes it possible to change the judgement conditions of processing units for the currently displayed scene without stopping the measurement processing.

#### ● Using the Simplified Non-stop Adjustment Mode

- 1** Select [Layout modification] from the [Window] menu.
- 2** In the Layout Modification Mode, select the layout number to use the Simplified Non-stop Adjustment Mode.
- 3** Click the upper right corner of the Flow Display Pane.
- 4** Change the [Unit setting mode] under [Flow Windows\_Setting] to [Simplified non-stop], and then click the [OK] button.
- 5** Click [Layout ended] on the Layout Modification Pane.  
Simplified Non-stop Adjustment Mode is enabled for the modified layout window.
- 6** Click the icon of the processing unit with the judgement condition to be adjusted.  
The [Judgement] dialog box for the selected processing unit is displayed.  
If you click the icon of the processing unit that does not have a [Judgement] setting item, the Judgement Pane is not displayed.

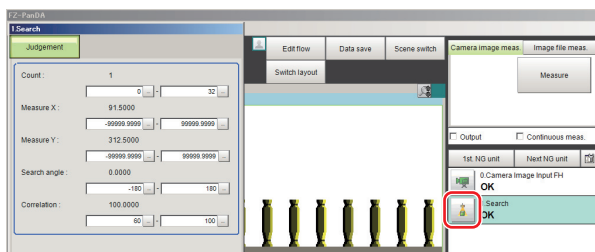

- 7** Modify the judgement conditions for the processing units.
- 8** Click [OK].  
The Judgement Pane closes, and the display returns to the Main Window.  
The changed contents are shown in the displayed scene.

If you need to modify the judgement conditions for more than one processing unit, repeat steps 6 to 8.

### ● Disabling the Simplified Non-stop Adjustment Mode

If the Simplified Non-stop Adjustment Mode is enabled, you cannot make detailed parameter settings for processing units.

To make detailed parameters for processing units, stop the measurement process and disable the Simplified Non-stop Adjustment Mode.

- 1** Select [Layout modification] from the [Window] menu.
- 2** In the [Layout number] on the Layout Modification Pane, select the layout number for which to disable the Simplified Non-stop Adjustment Mode.
- 3** Click the upper right corner of the Flow Display Pane.
- 4** Change the [Unit setting mode] under [Flow Windows\_Setting] to [Normal], and then click the [OK] button.
- 5** Click [Layout ended] on the Layout Modification Pane.

Simplified Non-stop Adjustment Mode is disabled for the modified Layout Window.



#### **Important**

---

- While Simplified Non-stop Adjustment Mode is being executed, do not switch the scenes or execute scene group switching.
  - Simple Non-stop Adjustment Mode can be applied to judgment conditions; for processing items that do not have judgment conditions, Simple Non-stop Adjustment Mode can not be used.
-

## 6-5-5 Changing Regions as a Batch [Shift area]

Figure data for multiple processing items can be changed as a batch.

- 1 In the edit flow window, click the [Shift area] button.  
The [Shift area] dialog box is displayed.

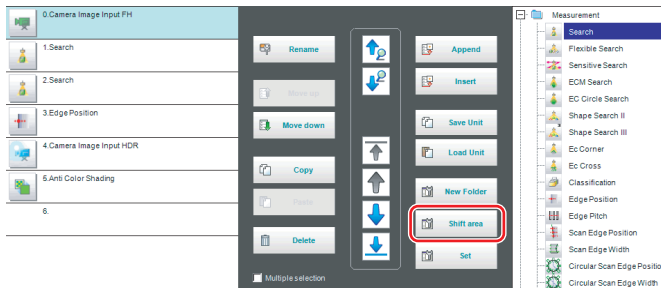

- 2 Select the processing item in which to change the region.  
Only image setting processing items included in [Input image] and [Compensate image] are displayed.

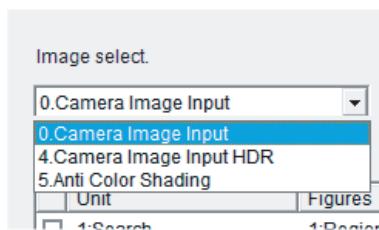

- 3 Select the registration region to change.

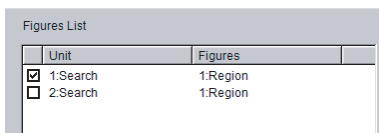

- 4 Click [Move] and input the value or click the arrows to move the image.  
Images can also be directly dragged to move them.

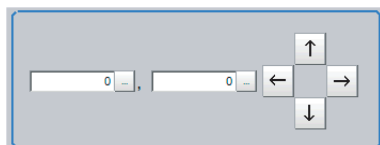

- 5 Click [OK].  
The change is registered.

## 6-6 Updating the Reference Position Data for a Unit in the Measurement Flow [Update Standard Position Tool]

This section describes the use of a table to set or change the reference position for more than one processing unit that you specify in the measurement flow.

To open the Update Standard Position Tool, select [Update standard position tool] from the [Tool] menu.

### Items That Can Be Updated with the Update Standard Position Tool

You can specify the following processing items.

- Search
- Sensitive Search
- Shape Search II
- Shape Search III
- EC Circle Search
- ECM Search
- Ec Corner
- Ec Cross
- Edge Position
- Scan Edge Position
- Circular Scan Edge Position
- Intersection
- Gravity and Area
- Labeling

### Operating Procedure for the Update Standard Position Tool

You can update the reference position for measurement items in the flow without the need to open the settings dialog box for each item.

For example, you can easily update the reference position that is updated frequently in an alignment application.

To update the reference position, display the image to use as the reference in advance.

When you click the [Measure ref.] button, the Controller measures the reference for all units that are selected in the [Unit Setting] list and updates the reference position.

If you click the reference position in the window, or enter the coordinates as a numeric value, the reference positions for the selected units in the [Unit Setting] list are updated with this value.



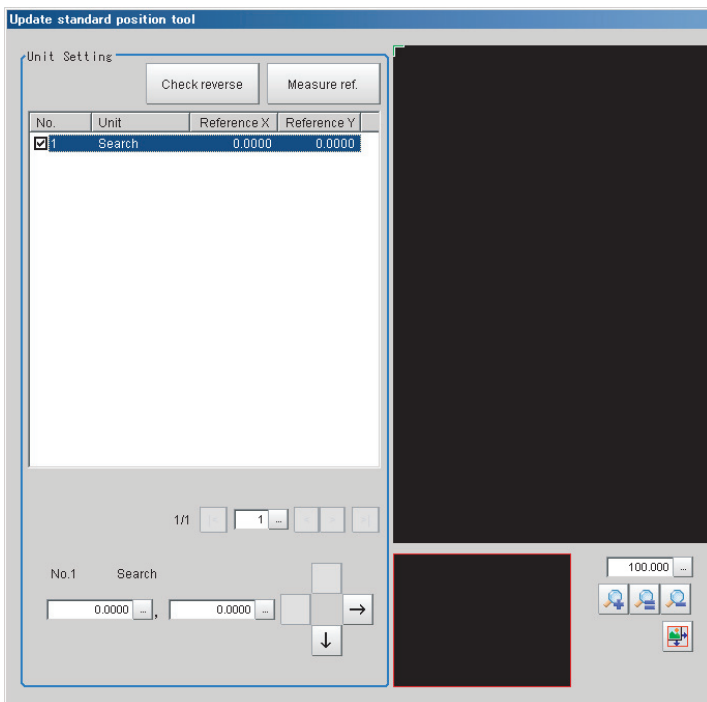

● **To Cancel Updating**

Click the [Cancel] button. You can return the reference positions to the values that were in effect before you opened this tool.



**Additional Information**

Most of the measurement items automatically update their reference positions when the model or measurement area is changed. If you need to change the reference position after it is updated, place the workpiece in the desired position, and then update the reference positions for all measurement units that you wish to change in the measurement flow.

**6-6-1 Monitoring Measurement Value Trends [Trend monitor]**

By monitoring the trends in measurement values, the occurrence of defects can be prevented in advance and this information can also be helpful in NG error occurrence cause analysis. Use the [Trend Monitor] processing item to monitor the measurement values.

Refer to *Trend Monitor* in the *Vision System FH/FHV/FZ5 Series Processing Item Function Reference Manual* (Cat. No. Z341).

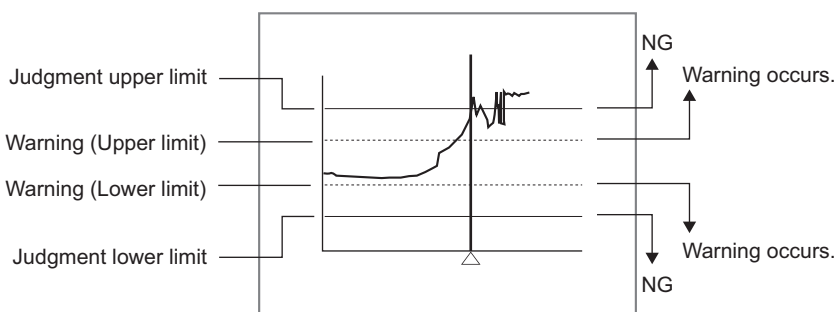



### Additional Information

---

- If the measurement value is within the alarm range, the [Warning] message is displayed.
  - If a result output-related processing item is used, this allows for output to external devices when a warning occurs.
  - Through trend monitor judgement, trends can be managed and NG error images can be saved.  
To save only NG error images identified by trend monitor judgement, create settings so that overall judgements from processing units other than [Trend Monitor] are not included in the judgement.
-

## 6-6-2 Clearing Measurement Results [Measurement Clear]

Use the following procedure to clear all of the currently displayed scenes.

This function sets the expression which calculates the measurement count, and is convenient when that count is to be reset.

- 1** In the adjustment window (layout 0), select [Clear measurement] from the [Function] menu.  
A confirmation dialog box is displayed.
- 2** Click [OK].  
The measurement results are deleted.

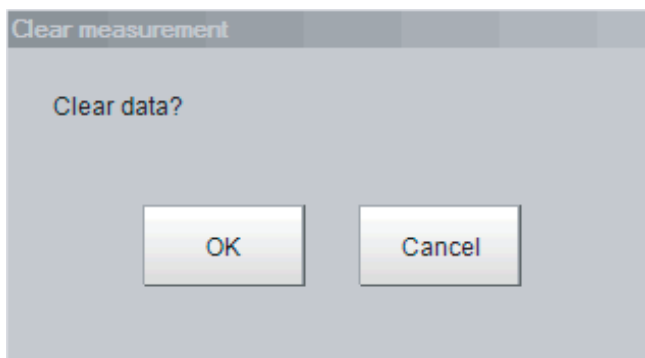

## 6-6-3 Clearing Saved Images [Logging Image Clear]

Use the following procedure to clear all of the images that are currently logged in the Controller.

- 1** In the Main Window (layout 0), select [Clear logging image] from the [Function] menu.  
A confirmation dialog box is displayed.
- 2** Click [OK].



### Additional Information

If you want to keep the logged images as files, save the logged images to the external storage by clicking [Function] – [Save to file] – [Logging image] before clearing them.

Refer to 9-4 *Saving Logged Images in the Controller Memory (RAM) to a RAMDisk or an External Storage Device* on page 9-10.

## 6-7 Managing Images used for Model Registration and Reference [Registered Image Manager]

You can save images used for model registration and reference registration as registration images and can reference them later and use them for re-registration and adjustment of reference positions.

You can register the [Latest logging image], [Logging image], and [Image file].



### Additional Information

By the following operation, the registered images can be managed.

- Click [TDM Editor] on the [Tool] in the Main window. The “Edit flow window” is displayed.  
Click [Registered image] on [Editing] in the menu bar. The “Registered image” window is displayed.



### Important

- When using this function, an external storage device such as USB memory stick or USB HDD that can be connected via USB slot is required.
- The registered image is saved in the external storage.
- Do not change the configuration of files in the external storage. Changing it would make it impossible to read the files.
- Image files in the JPG (JFZ) format cannot be registered / loaded.

### 6-7-1 Specifying the Destination to Save

Specify an external storage device and folder to save registered images.

- 1 Insert an external storage such as a USB memory stick into the sensor controller.  
When specifying a network drive as the destination to save, set the network drive beforehand.  
For details, refer to *4-13 Setting Network Drive [Network Drive Setting]* on page 4-53.
- 2 In the Main window, select and click [Tool] → [Registered Image Manager].  
“Registered image” dialog box is displayed.

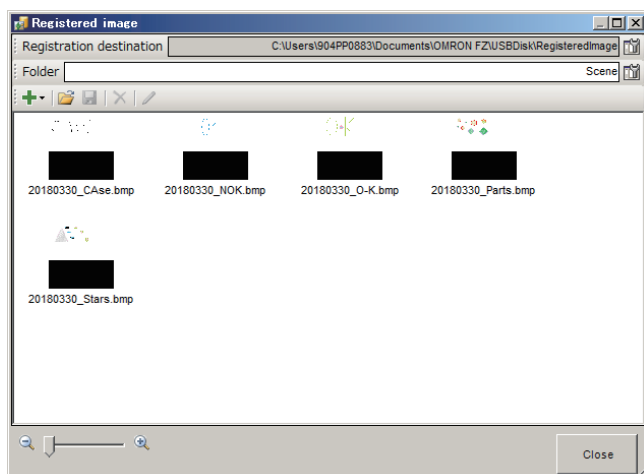

- Click the  on the right side of the "Registration destination" text box. "Select folder" dialog box is displayed.

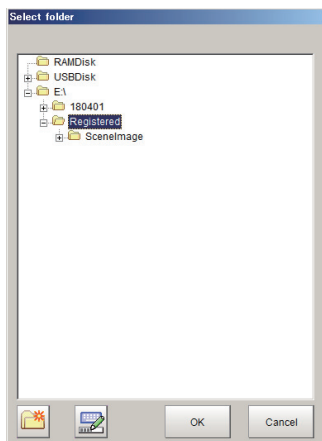



 **Additional Information**

This setting will not be initialized even when [System initialization] in [Tool] is executed.

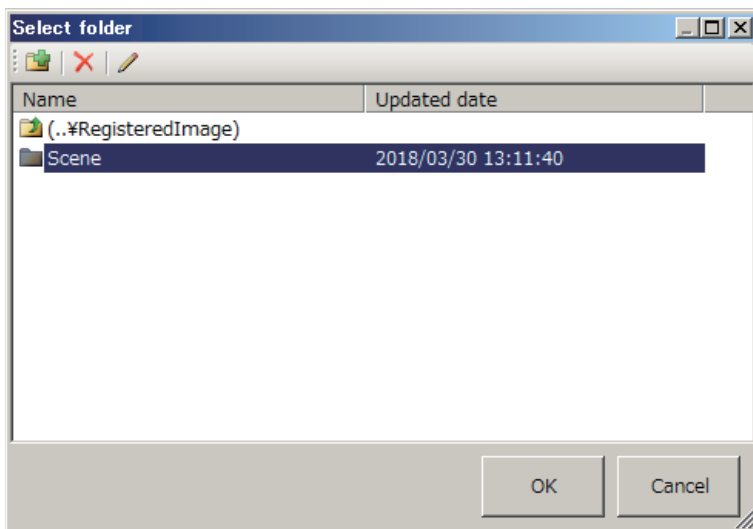
- Specify, change, or newly create the root directly for the destination and click [OK]. The root directly for the registered image is set.
- Click  on the right side of "Folder" text box to set a sub-folder. "Select folder" dialog box is displayed.



- Specify, change, or newly create a sub-folder.
- Click [OK]. The sub-folder is set.

Icon/Button	Function	Description
	New folder	Creates a new folder.
	Delete	Deletes the selected folder.

Icon/Button	Function	Description
	Rename	Renames the selected folder.



### Important

- When the sensor controller uses and reads data set in a folder in the C drive on the simulation software, must be change the setting. As the registration image folder, the C drive cannot be used by the sensor controller.
- The registration image folder name will be saved as the system data when clicking [Data save] on the Main window.



### Important

Registered images can be also managed in the following procedures.



- Thumbnail image display in the registration image window may not be available when the registration images are too many.
- You can also manage registered images with the following operation.
  - In the Main window, click [Tool] → [TDM editor] to display “Edit flow” tab screen.
  - Click [Editing] → [Registered image] to display “Registered image” dialog box.

## 6-7-2 Registering Images

Register images.

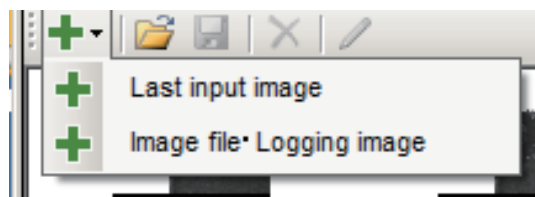
- 1** Insert an external storage such as USB memory sticks to the sensor controller.
- 2** In the Main window, Click [Tool] - [Registered Image Manager].  
“Registered image” dialog is displayed.
- 3** Click [Registration] or [Open] to select an image to register.



Icon/Button	Function	Description
	Registration Last input image	Registers the last image that is used in the current measurement. It can be saved with any name.
	Registration Image file/Logging image	Registers Logging images or saved image files in the main memory. Selecting an image file can be done via the displayed FileExplorer.
	Open	Copies all images in the specified folder to the displayed registration destination folder (sub-folder). Specifying the folder is done via the displayed folder selection window.

- 4** Click [Registration] to register the selected image.  
When clicking [Registration], the registered image name can be renamed in the “Registered image” dialog.

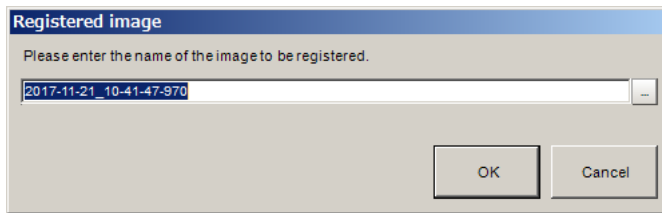

- 5** Click [OK].

### 6-7-3 Renaming Image Names

Rename registered image names.

- 1** Click [Tool] -> [Registered Image Manager].  
“Registered image” window is displayed.
- 2** Select the image to change the name and click [Rename].  
“Rename” dialog box is displayed

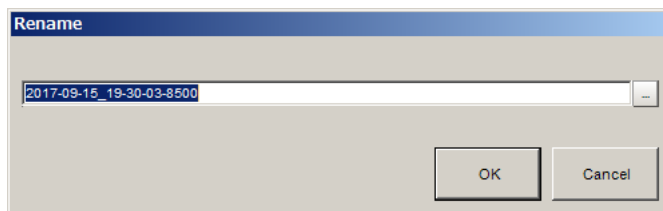

- 3** Click [OK].  
The image name is renamed.

### 6-7-4 Deleting Images

Delete registered images.

- 1** Click [Tool] -> [Registered image manager] on the Main window.  
“Registered image” window is displayed.
- 2** Select the image to delete and click [Delete].  
“Precaution” message is displayed.

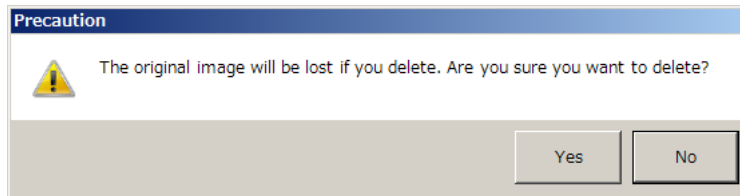

- 3** Click [Yes].  
The selected image is deleted.

### 6-7-5 Loading Images

A registered image can be loaded as a measurement image.

- 1** Click [Tool] -> [Registered image manager] on the Main window.  
“Registered image” window is displayed.
- 2** Select the image to load and click [Save].  
The selected image is loaded into the selected folder.

Icon/Button	Function	Description
	Save	Saves the image in the displayed registration destination folder (sub-folder) to the specified folder. Specifying the destination folder is done via the displayed folder selection dialog box.



## 6-8 Verifying Calibration Results [Calibration Support Tool]

### ● Checking the Calibration Results

The Calibration Support Tool uses the calibration parameters to graphically display the relationship of the positions that are represented by the Camera coordinates and the real coordinates. You can compare the relationship of the displayed position with the real position of the equipment. This allows you to easily check the validity of the calibration parameters. To start the Calibration Support Tool, select [Tool] - [Calibration support tool].

### 6-8-1 Data Setting

Graphically display the position relationship between the camera coordinates and the real coordinates.

- 1 Click  or  to set the Display data No.
- 2 Click  to select a processing unit number holding the calibration data.  
The following processing units can be specified.

- Camera Image Input
- Camera Image Input HDR
- Camera Image Input HDR Lite
- Camera Image Input FH
- Vision master Calibration
- PLC Master Calibration
- Calibration Data Reference
- Precise Calibration

- 3 Sets Data No. for displaying calibration data by clicking  or .

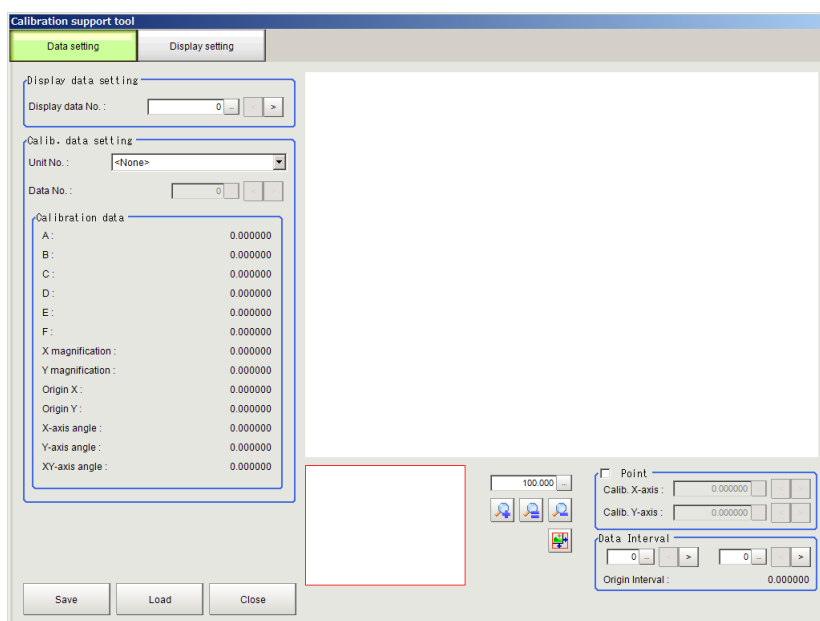

Setting item	Setting value [Factory default]	Description
Display data setting		
Display data No.	0 to 7	Sets a data number to display.
Calib. Data setting		
Unit No.	[None]	Sets a processing unit number that holds the calibration data.

Setting item	Setting value [Factory default]	Description
Data No.	0 to the number of data that the selected unit is held.	Sets a calibration data number to display.
Calibration data		Displays calibration data for graphical display target.
Graphic display area		Graphically displays a camera coordinate system and a real coordinate system. When the Point is effective, the real coordinate X/Y is updated when clicking the area.
Point	<ul style="list-style-type: none"> <li>[Unchecked]</li> <li>Checked</li> </ul>	Displays the real coordinate data by pointing a point on the area. When the Point is checked, the point coordinate setting is effective.
Calib. X/Y-axis	-99999.9999~99999.9999	Sets X/Y coordinates for the cursor to be displayed on the area.
Data Interval	0 to 7	Sets two data numbers to calculate the origin interval distance between the data.
Origin interval	[0.000000]	Displays the calculated distance above.

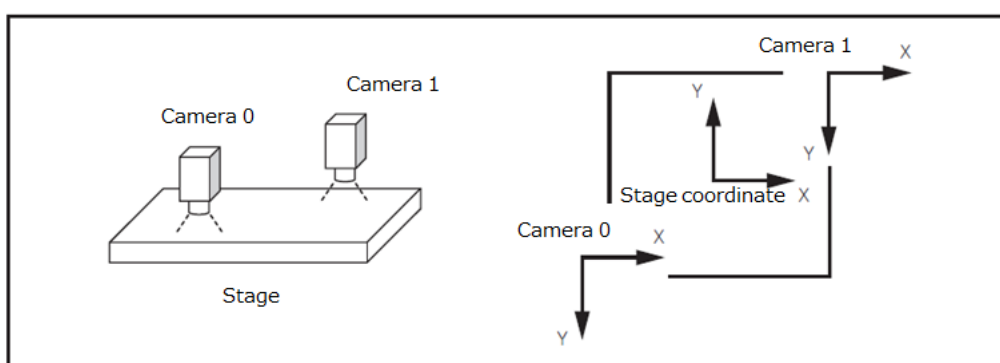

If cameras are arranged above, the position of the camera 0/1 are displayed on the area as similar as the actual camera position. If not, then re-calibrate it.

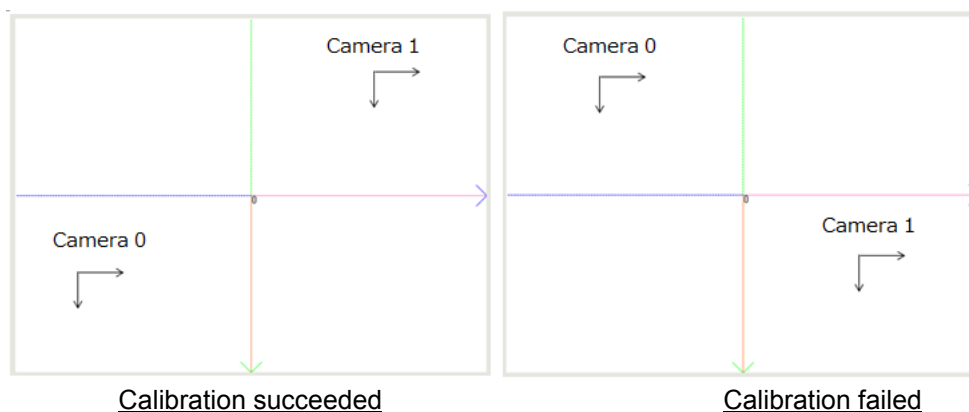



# 7

## Increasing/Switching Measurement Scenes

---

---

<b>7-1</b>	<b>What Is a Scene Group?</b> .....	<b>7-2</b>
<b>7-2</b>	<b>Switching the Scene or Scene Group</b> .....	<b>7-4</b>
7-2-1	Switching the Scene .....	7-4
7-2-2	Switching Scene Groups .....	7-4
<b>7-3</b>	<b>Editing Scenes [Scene Maintenance]</b> .....	<b>7-6</b>
7-3-1	Copying Scenes .....	7-6
7-3-2	Deleting Scenes .....	7-6
7-3-3	Renaming a Scene and Adding a Description .....	7-7
<b>7-4</b>	<b>Editing Scene Groups [Scene Maintenance]</b> .....	<b>7-8</b>
7-4-1	Copying and Deleting Scene Groups .....	7-8
7-4-2	Renaming the Scene Group Name .....	7-9
<b>7-5</b>	<b>Saving Scene Groups in External Storage [Scene Group Saving Destination Settings]</b> .....	<b>7-10</b>
<b>7-6</b>	<b>Increasing the Number of Scenes in a Group to more than 128 Scenes [Conversion Scene Group Data Tool]</b> .....	<b>7-12</b>

## 7-1 What Is a Scene Group?

A scene group is a collection of up to 128 separate scenes. Creating scene groups is convenient to increase the number of scenes and to manage scenes according to categories.

For the FH5-L series or FZ5-600 series, a USB memory is required to create scene groups. Scene group 0 is saved in the Controller, while scene groups 1 to 31 are saved in USB memory. (For the FH series/FZ5-1100 series, all data is saved in the Controller.)

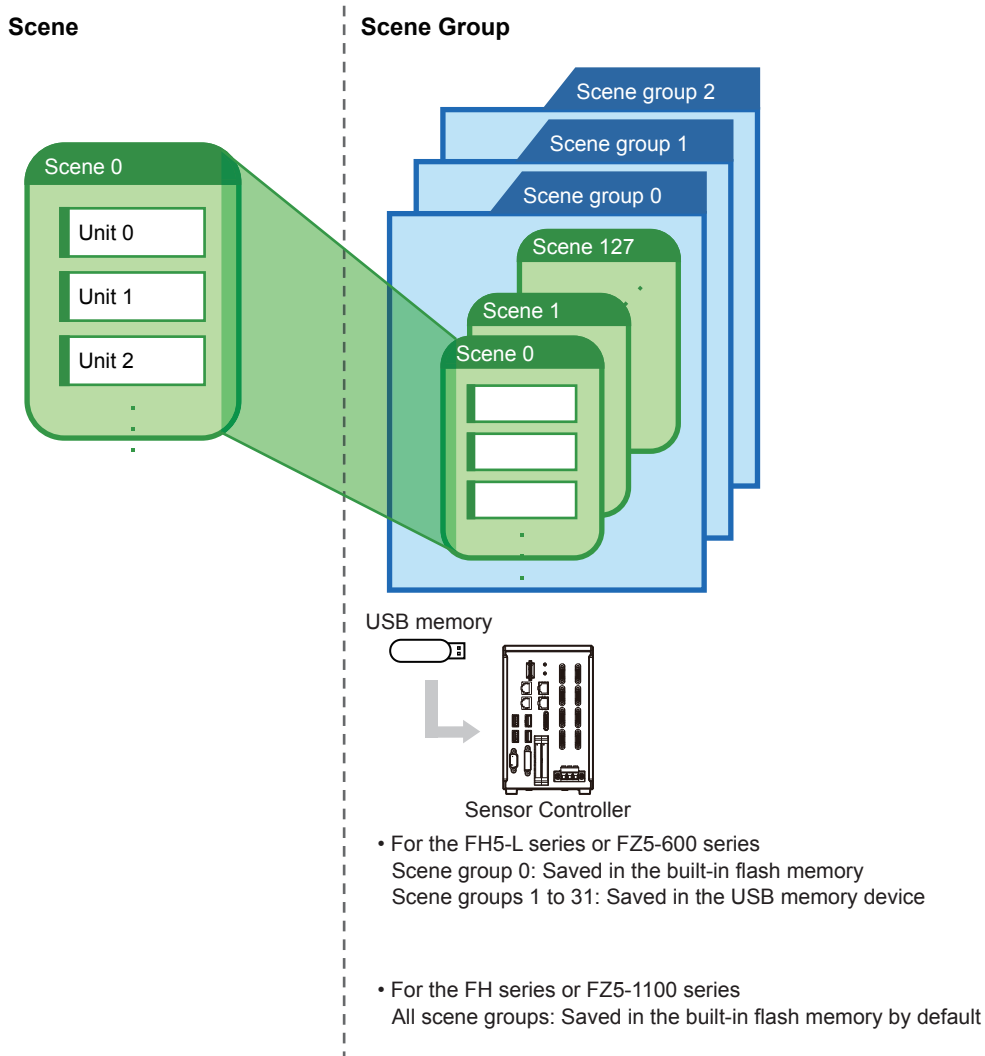



### Additional Information

---

- Up to 128 scenes can be handled as one scene group, and up to 32 scene groups can be set. You can therefore use 128 scenes × 32 scene groups, or 4,096 scenes.
  - For the FZ5-L series/FZ5-600 series, the drive name of the USB memory device must be named “USBDisk” for it to be used as the destination for scene groups 1 to 31. The names “USBDisk2” to “USBDisk4” cannot be used for saving. When other USB memory devices are already inserted for the USB disk, perform operations only after removing all USB memory devices other than the one in which the scene group data is stored.
  - If the external storage capacity is insufficient for the data size, 4,096 scenes cannot be set. The scene data size depends on the settings.
  - Check the amount of memory used and free data memory from the menu of Memory Consumption Monitor on the Measurement Management Bar or the System Menu.  
Refer to 3-4 *Checking the Memory Consumption and Percentage of Memory Used* on page 3-31 and 3-3 *Checking System Information* on page 3-27.
-

## 7-2 Switching the Scene or Scene Group

You can switch the scene to perform a process change. The default display is scene 0 when the power supply is turned ON. You can create many scenes (scenes 0 to 127).

Also, if you use scene groups, you can set up to 4,096 scenes.

You can also send commands from an external device to switch the scene group or scene

For details, refer to *Vision System FH/FHV/FZ5 Series User's Manual for Communications Settings* (Cat. No. Z342).

### 7-2-1 Switching the Scene

- 1 In the Main Window (layout 0), click the [Scene switch] button in the Toolbox Pane  
The [Scene switch] dialog box is displayed.

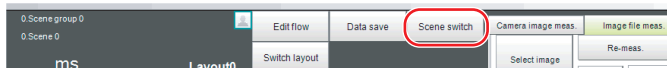

#### Additional Information

An alternative operation is to select [Switch scene] from the [Function] menu.

- 2 Click [▼] to select the scene to switch to.  
To change the scene group, click [Switch], and then click [▼] in the displayed dialog box to select the scene group to switch to.

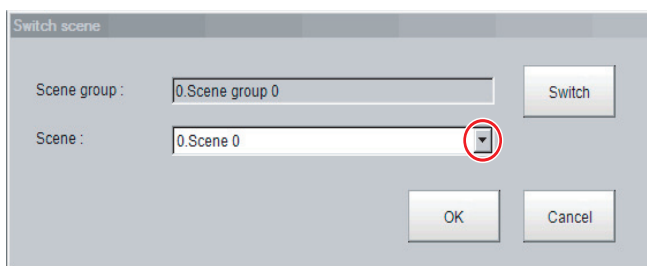

- 3 Click [OK].  
The scene is switched to the specified one.

### 7-2-2 Switching Scene Groups

Use the following procedure to switch to the scene group in which the scene to be edited is stored.

- 1 In the Main Window (layout 0), select [Scene maintenance] from the [Function] menu.  
The [Scene maintenance] dialog box is displayed.
- 2 Click the [Switch] button in the Scene Group Area.  
The [Scene group switch] dialog box is displayed.

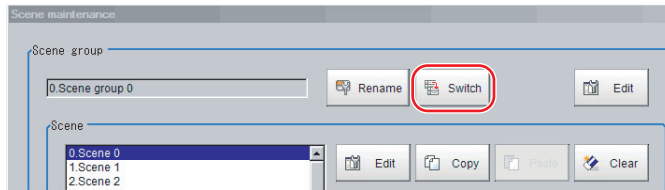

- 3 Switch to the scene group to edit.

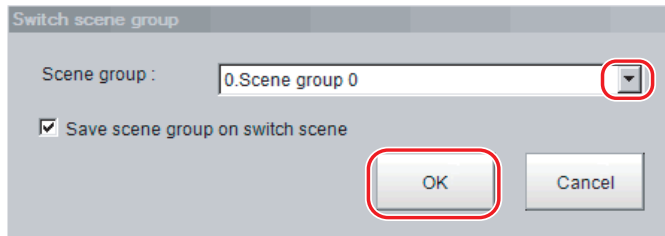

- (1) Click the [▼] button to select the scene group to edit.
- (2) Select whether the scene group should be saved when switching to another scene group.

Parameter	Set value [Factory default]	Description
Save scene group on switch scene	[Selected]	When the scene group is switched, the data of the scene group before changing is saved.
	Not selected	The scene group data is not saved when you switch to another scene group. Therefore, you can switch the scene group faster.



#### Additional Information

The setting for whether to save a scene group when switching is linked to the settings of the [Measure setting] dialog box. Refer to 4-15 *Setting the Conditions that are Related to Operation during Measurement [Measurement Conditions]* on page 4-58.

- (3) Click [OK].

The scene group is switched and the [Scene maintenance] dialog box is displayed again.



#### Important

- If you select [Save scene group on switch scene], data may be lost if the power supply is turned OFF while switching the scene group. Make sure that the power supply is not turned OFF while the scene group is being switched.
  - If the available external storage is not sufficient to save data when switching the scene group, the data will be initialized if the power supply is turned OFF because the scene group data in the external storage is temporarily cleared during the saving process. To avoid this problem, increase the available external storage without turning OFF the power supply or reduce the scene group data size, and save the data to the external storage again.
  - Immediately after starting up the FH series/FZ5 series Sensor Controller and immediately after switching scenes, there will be no input image. No input image is processed as the same color image as in the factory default state.
  - If you open the Properties Dialog Box before inputting an image, click the Cancel button to close the dialog box. Clicking the OK button in the dialog box will change the setting to the same color camera setting as the factory default setting.
- Refer to "NG (memory shortage)" is displayed in the "Detail result" area on page 11-10.

## 7-3 Editing Scenes [Scene Maintenance]

### 7-3-1 Copying Scenes

Use the following procedure to copy and paste a scene within a scene group.

This is convenient for reusing a scene and changing only the required parts.

- 1** In the Main Window (layout 0), select [Scene maintenance] from the [Function] menu.  
The [Scene maintenance] dialog box is displayed.
- 2** In the scene list, click the scene to copy, and then click [Copy]

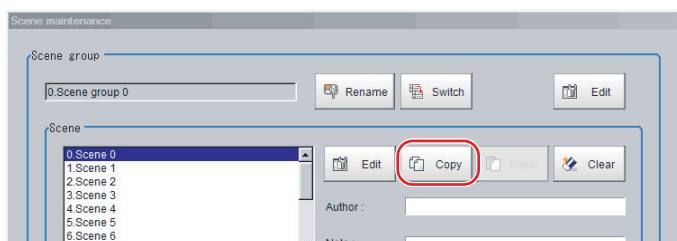

- 3** In the scene list, click the scene where the copy is to be made, and then click [Paste].  
An overwrite confirmation dialog box is displayed.
- 4** Click [Yes].  
The scene selected as the destination is overwritten with the copied scene data.
- 5** Click the [Close] button.

### 7-3-2 Deleting Scenes

Use the following procedure to delete the settings and return to the default values. Use the following procedure to initialize the measurement contents for a scene.

- 1** In the Main Window (layout 0), select [Scene maintenance] from the [Function] menu.  
The [Scene maintenance] dialog box is displayed.
- 2** Click the scene to be deleted from the scene list.
- 3** Click the [Clear] button.  
A confirmation message is displayed.

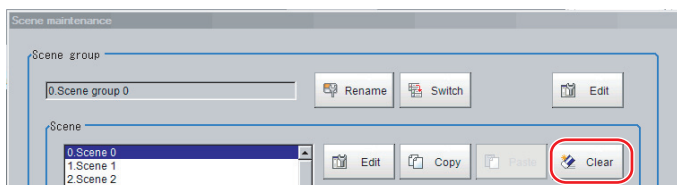

- 4** Click [Yes].  
The scene data is deleted.
- 5** Click the [Close] button.



### 7-3-3 Renaming a Scene and Adding a Description

A user description can be added to each scene. This is convenient for making settings more easily understandable when managing many scenes.

- 1** In the Main Window (layout 0), select [Scene maintenance] from the [Function] menu.  
The [Scene maintenance] dialog box is displayed.
- 2** Click the scene to be renamed from the scene list.
- 3** Click the [Edit] button.
- 4** Set the [Scene name], [Author], and [Note].
  - (1) Click the [· · ·] button for each item.  
The on-screen keyboard is displayed.
  - (2) Set the names and a note.  
Input the [Scene name], [Author], and [Note] within 1,023 characters respectively.  
You cannot use ° (semi-voiced sound symbol) and ° (voiced sound symbol) in the [Scene name].



#### Additional Information

The [Scene name] supports multi-lingual.

For details, refer to 3-2-2 *Inputting Text* on page 3-7.

- 5** Click [OK].
- 6** Click the [Close] button.

## 7-4 Editing Scene Groups [Scene Maintenance]

Copying or deleting can be done by scene group and scene groups can be renamed.



### Additional Information

For the FZ5-L series or FZ5-600 series, make sure to check that a USB memory device has been inserted before performing this operation.

### 7-4-1 Copying and Deleting Scene Groups

- 1** In the Main Window (layout 0), select [Scene maintenance] from the [Function] menu.  
The [Scene maintenance] dialog box is displayed.
- 2** Click the [Edit] button.  
The [Scene group maintenance] dialog box is displayed.

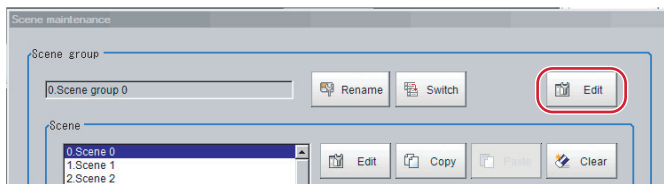

#### ● Copying

- 3** Select the scene group to copy, and then click the [Copy] button.

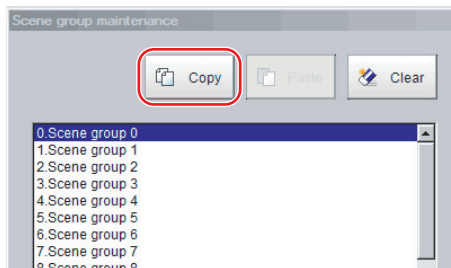

- 4** Select the copy destination scene group and click [Paste].  
An overwrite confirmation dialog box is displayed.
- 5** Click [Yes].  
The scene group selected as the destination is overwritten with the copied scene group data.
- 6** Click the [Close] button.

## ● Deleting

The following data is deleted.

- Name set for the scene group
- All scene data within the scene group

- 7 Select the scene group to delete, and then click the [Clear] button.  
A confirmation message is displayed.

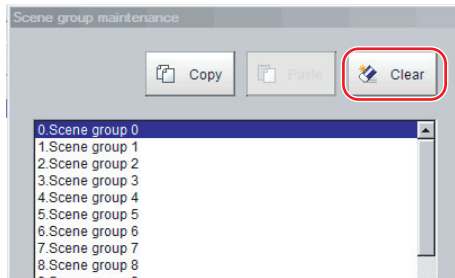

- 8 Click [Yes].  
The scene group data is deleted.
- 9 Click the [Close] button.

## 7-4-2 Renaming the Scene Group Name

Scene groups can be named with any desired text. This is convenient to make scene groups easier to identify when there are many scene groups to manage.

- 1 In the Main Window (layout 0), select [Scene maintenance] from the [Function] menu.  
The [Scene maintenance] dialog box is displayed.
- 2 Click the [Rename] button.  
The [Scene group maintenance] dialog box is displayed.

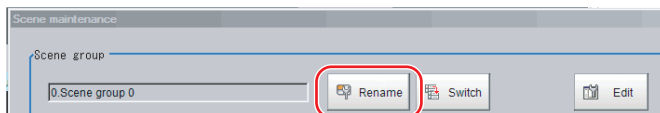

- 3 Click [...] next to [Scene group name].  
The on-screen keyboard is displayed.

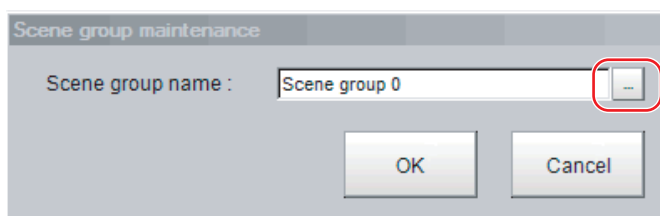

- 4 Set the name.  
Input it within 15 characters. The [Scene group name] supports multi-lingual. (For details, refer to 3-2-2 *Inputting Text* on page 3-7.)
- 5 Click [OK].
- 6 Click the [Close] button.

## 7-5 Saving Scene Groups in External Storage [Scene Group Saving Destination Settings]

The scene group storage location specification function lets you specify a location other than the Sensor Controller's flash memory for saving scene group data. After specifying the desired storage location with this function, menus and buttons such as "Data save" save set data in the specified external storage instead of in the Sensor Controller's flash memory. This function is handy as it enables use of the external storage when the volume of scene group data is too large to save all of it in the Sensor Controller's flash memory.

This function can not be used with the FHV series.

- 1 Select [Scene Group Saving Destination Setting] from the [Tool] menu in the main screen. A screen for specifying the scene group storage location appears.
- 2 Set each item in the [Scene group saving destination on settings] area.

Variable name	Set value [Factory default]	Content
Scene Group Saving Destination Setting	<ul style="list-style-type: none"> <li>• [Save all scene group data in the flash memory]</li> <li>• Save all scene group data in the external storage device</li> <li>• Save after the next scene group data in the external storage device</li> </ul>	Sets the storage location for scene group data. <ul style="list-style-type: none"> <li>• Store all in Sensor Controller memory</li> <li>• Store all in an external storage device</li> <li>• Store scene groups after scene group below in an external storage device</li> </ul>

Variable name	Set value [Factory default]	Content
Scene group No.	0 to 9999[1]	This setting is valid when [Save after the next scene group data in the external storage device] is selected for [Scene Group Saving Destination Setting]. Used to set the number of the first scene group to store in the external storage. For the FH/FHV/FZ5 series, if 32 or above is specified for the scene group number, all scene group data will be saved to the Sensor memory.

### 3 Set each item in the [External storage device settings] area.

Variable name	Set value [Factory default]	Content
External storage device settings	---	This setting is valid when [Save all scene group data in the external storage device] or [Save after the next scene group data in the external storage device] is selected for [Scene Group Saving Destination Setting]. Used to set the storage location folder.

### 4 Click [OK].

The scene group storage location is changed, and the current scene group data is transferred from the current storage location to the new storage location. An error message is displayed if the transfer fails.



#### Important

- An error message is displayed if scene group data storage or reading fails. See "Error Messages and Troubleshooting" in the Appendices for descriptions of error messages. Refer to *11-1 Error Messages and Troubleshooting* on page 11-2.
- When the scene group data storage location setting is changed, a file with the [\*.scg] file extension is created at the new storage location. Do not change the file name or file extension of this scg file. If you change, the setting will not be saved or read correctly.
- When you change the Scene group save destination, the original data in the save destination will be deleted. The data in the original save destination will be deleted. Make sure to back up data for use in case of malfunction, or corrupted data.
- The Sensor Controller may fail to load a scene group at the Sensor Controller start-up because a recognition delay for external storage happens depending on models or number of connections of external storage. Use the Device Information Storage Tool when saving a scene group data to external storage. Refer to *3-6-2 Device Information Storage Tool* on page 3-35.



#### Additional Information

- You can check the available capacity of the external storage in the setting screen. We recommend that you check whether your external storage has enough available capacity before changing the storage location.
- Clicking [Restore the defaults] restores the settings to their factory default values. Factory default settings differ as follows:
  - FZ5-L series/FZ5-600 series:  
Scene group 0 is stored in the Sensor Controller's flash memory.  
Scene groups 1 and after are stored in the external storage.
  - FH series/FZ5-800/1100/1200 series:  
Scene group 0, Scene group 1, and after are stored in the Sensor Controller's flash memory.

## 7-6 Increasing the Number of Scenes in a Group to more than 128 Scenes [Conversion Scene Group Data Tool]

---

You can increase the number of scenes in a scene group to more than 128 scenes.

To start the Conversion Scene Group Data Tool, select [Conversion scene group data tool] from the [Tool] menu.

### Overview

---

Normally, there are 128 scenes in a scene group.

For example, if you need to create scenes for each model and there are more than 128 models, you would normally create more than one scene group to manage the scenes.

However, you can use the Conversion Scene Group Data Tool to increase the number of scenes in a scene group to up to 1,024 scenes. A scene group data file (extension \*.sgp) is used as the target data.

The ability to manage all of the scenes in one scene group even if there are more than 128 scenes simplifies the PLC control programming and data management.



#### Important

---

If you increase the data size of a scene group, you may not be able to save the data in the Controller or load the data from a file, depending on the number of scenes and the settings.

If that occurs, change the measurement flow, separate the scene group, or otherwise reduce the data size of the scene group.

---



#### Additional Information

---

For best results, organize the scenes in the scene groups before you use the Conversion Scene Group Data Tool. For example, arrange the scenes in the proper order, delete unnecessary scenes, and assign scene names.

Refer to 7-3 *Editing Scenes [Scene Maintenance]* on page 7-6.

---

## Operating Procedure for the Conversion Scene Group Data Tool

When you start the Conversion Scene Group Data Tool, the following dialog boxes are displayed in order.

You complete the following three dialog boxes as a progressive process that sets, edits, and converts the scene group data.

Step 1: Set the target data to convert.

Step 2: Edit the data.

Step 3: Execute the conversion process.

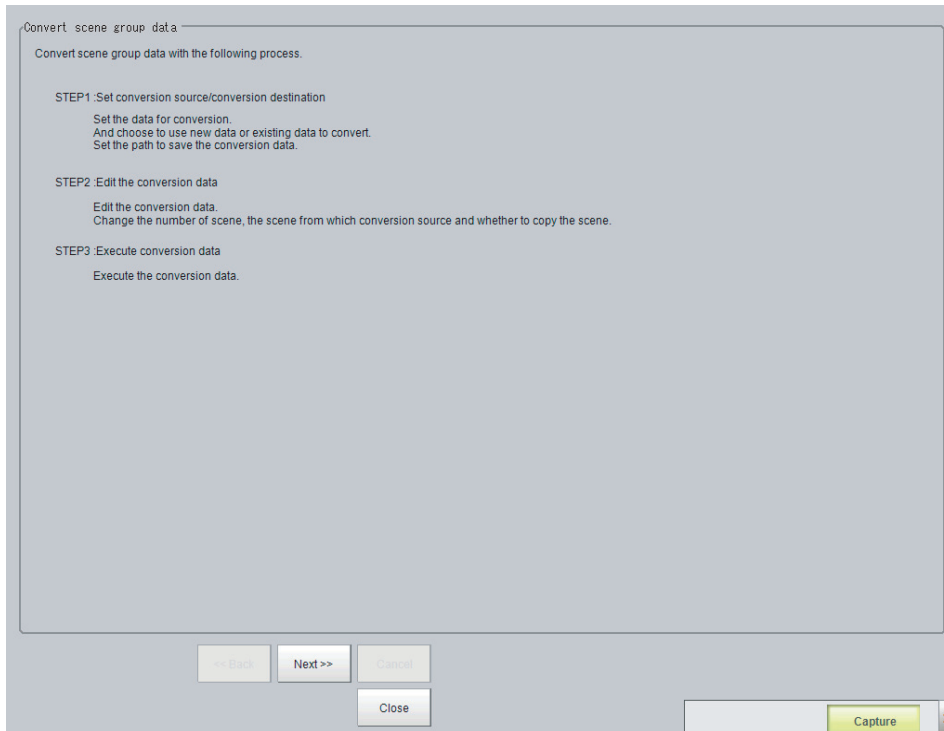

Use the following procedure and the guidance in the dialog boxes to perform the conversion process.

- 1** Select [Conversion scene group data tool] from the [Tool] menu.  
The Conversion Scene Group Data Tool is started.
- 2** Click the [Next] button. The [STEP 1] dialog box is displayed.

STEP1 :Set conversion source/conversion destination

Set the data for conversion.  
And choose to use new data or existing data to convert.  
Set the path to save the conversion data.

Conversion source  
File name :

Conversion destination  
 New  
 Modification  
 File name :

Save folder  
File name :

<< Back   Next >>   Cancel   Close

Capture

- 3** Specify the target data file to convert, the destination data file, and the destination. Then click the [Next >>] button. The [STEP 2] dialog box is displayed.

STEP2 :Edit the conversion data

Edit the conversion data.  
Change the number of scene, the scene from which conversion source and whether to copy the scene.

Conversion source      Conversion destination      Number of scenes : 256

Scene      Scene      Conversion information

0.Scene 0  
1.Scene 1  
2.Scene 2  
3.Scene 3  
4.Scene 4  
5.Scene 5  
6.Scene 6  
7.Scene 7  
8.Scene 8  
9.Scene 9  
10.Scene 10  
11.Scene 11  
12.Scene 12  
13.Scene 13  
14.Scene 14  
15.Scene 15  
16.Scene 16  
17.Scene 17  
18.Scene 18  
19.Scene 19  
20.Scene 20  
21.Scene 21  
22.Scene 22  
23.Scene 23  
24.Scene 24  
25.Scene 25  
26.Scene 26  
27.Scene 27

>>      <<

Select all   Cancel all      Select all   Cancel all

<< Back   Next >>   Cancel   Close

Capture



**4** Edit the scene in the converted scene group.

Click the [>>] button to copy the conversion source to the conversion destination. Click the [<<] button to copy the conversion destination to the conversion source.

When you have done editing, click the [>>] button. The [STEP 3] dialog box is displayed.

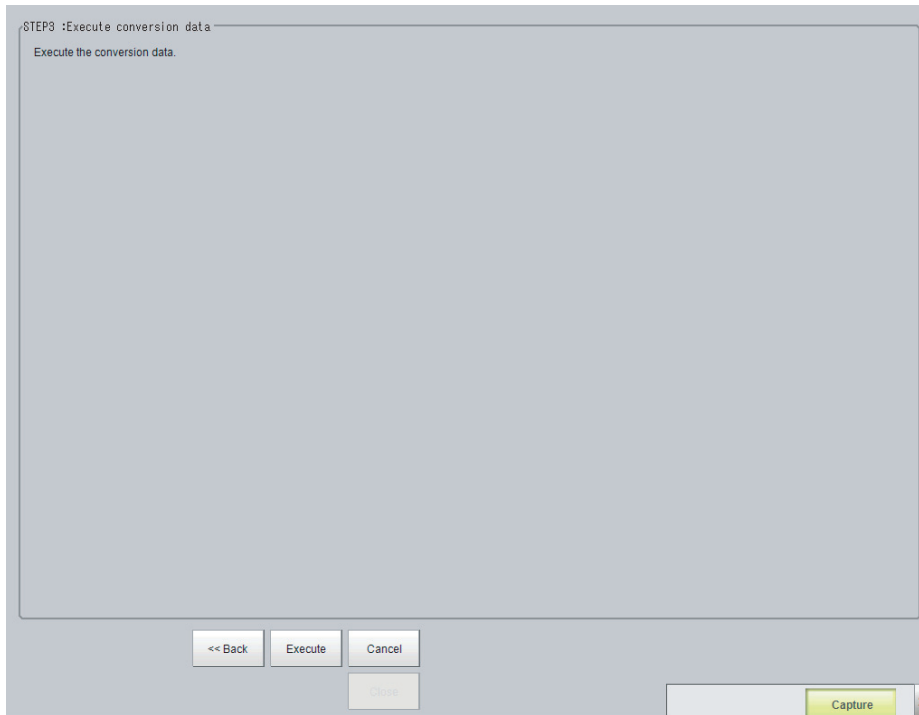
**5** Specify the destination for the converted file, and then click the [Execute] button.

A progress bar is displayed and the conversion is executed.



# 8

## Setting Windows

<b>8-1</b>	<b>Windows</b>	<b>8-3</b>
8-1-1	Types of Windows	8-3
8-1-2	Overview of Window Navigation	8-4
8-1-3	Main Window (Layout 0): Adjustment Window (Default)	8-5
8-1-4	Main Window (Layout 1): Run Window (Default)	8-10
<b>8-2</b>	<b>Adjustment Windows and Run Windows</b>	<b>8-11</b>
8-2-1	Main Window (Layout 0): Adjustment Window (Default)	8-11
8-2-2	Main Window (Layout 1): Run Window (Default)	8-12
8-2-3	Main Window (Layout 1): Switching to the Run Window	8-12
8-2-4	Main Window (Layout 1): Switching to the Adjustment Window	8-13
<b>8-3</b>	<b>Arranging Windows [Layout Functions]</b>	<b>8-14</b>
8-3-1	Arranging Window Elements (Layout Modification)	8-14
8-3-2	Setting the Behavior of Output Signals for Each Layout [Layout Settings]	8-25
8-3-3	Switching Layout Numbers in the Main Window [Layout Switching]	8-26
8-3-4	Judgement Pane	8-27
8-3-5	Information Pane	8-27
8-3-6	Toolbox Pane	8-28
8-3-7	Measurement Pane	8-30
8-3-8	Flow Display Pane	8-30
8-3-9	Detail Result Pane	8-31
8-3-10	Image Container Pane	8-32
8-3-11	Error Pane	8-35
8-3-12	Image File Display Pane	8-37
8-3-13	Label Pane	8-39
8-3-14	Extended Window Parts	8-40
8-3-15	Data Grid Window (MDI_DataGrid.dll)	8-41
8-3-16	Login Account Display Window (MDI_DisplLoginUser.dll)	8-47
8-3-17	Setting Dialog Box Display Button Window (MDI_DisplSetupBtn.dll)	8-48
8-3-18	Text Display Window (MDI_DisplText.dll)	8-51
8-3-19	Custom Dialog Display Button Window (MDI_ExecuteBtn.dll)	8-53
8-3-20	Macro Trigger Window (MDI_McrTrigger.dll)	8-56
8-3-21	Message Box Display Window (MDI_MsgBox.dll)	8-57
8-3-22	Value Input Window (MDI_NumBox.dll)	8-58

8-3-23	Data Settings Button Window (MDI_SetDataBtn.dll)	8-60
8-3-24	Simple Data Grid Window (MDI_SimpleDataGrid.dll)	8-63
8-3-25	Troubleshooting	8-66
<b>8-4</b>	<b>Creating a Custom Dialog Box [Custom Dialog Functions]</b>	<b>8-67</b>
8-4-1	Flow of Use	8-67
8-4-2	Custom Dialog Tool	8-68
8-4-3	Launching Your Custom Dialog Box	8-86

# 8-1 Windows

## 8-1-1 Types of Windows

There are 9 windows (with layout numbers 0 to 8) that you can use to set and operate an FH/FHV/FZ5.

Layout	Application
Layout 0	Layout 0 is the adjustment window by default. Refer to <i>8-2-1 Main Window (Layout 0): Adjustment Window (Default)</i> on page 8-11.
Layout 1	Layout 1 is a run window by default. Refer to <i>8-2-2 Main Window (Layout 1): Run Window (Default)</i> on page 8-12.
Layout 2 to layout 8	Layouts 2 to 8 are for user-defined purposes and are created as they are needed. Refer to <i>8-3 Arranging Windows [Layout Functions]</i> on page 8-14.  For example, if more than one line is being controlled, you can set and use a separate window for each line. Refer to <i>Multi-line Random-trigger Mode</i> on page 4-19.



### Additional Information

If necessary, you can change layout 0 and layout 1 from the default adjustment window and run window and use them for other purposes.



### Important

If the operation mode is set to Multi-line Random-trigger Mode, you must create a layout for each line. Refer to *Multi-line Random-trigger Mode* on page 4-19.

### 8-1-2 Overview of Window Navigation

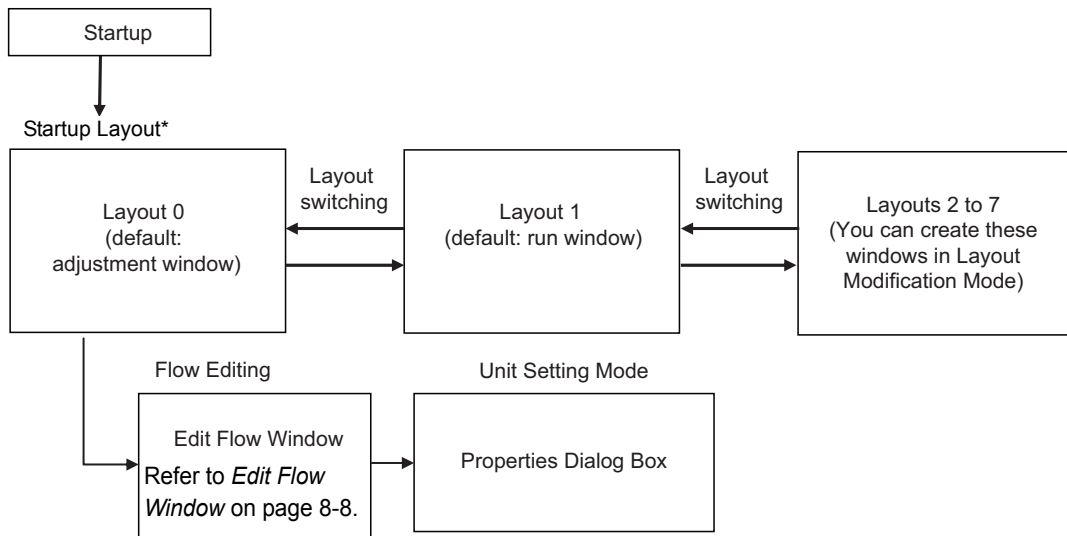

\* Select as follows: [System settings] – [Startup setting] – [Basic] tab – [Startup layout].  
 Default: [Layout 0] (both local and remote)

### 8-1-3 Main Window (Layout 0): Adjustment Window (Default)

You use this window to set up a measurement process and perform test measurements to confirm whether the measurements are processed as intended.

Based on the results of the test measurement, move to the property settings for each processing unit and make adjustments.

When the Main Window (layout 0) is being displayed, measurement results are not output and the RUN signal remains OFF. (Layout modification can be used to change the layout.)

You can manually execute or stop test measurements.

If the measurement results are stable, switch to the Main Window (layout 1) and perform measurements.



#### Additional Information

Use the following procedure to switch to Main Window (layout 1).

Select [Switch layout] from the [Function] menu (default layout).

#### Names of the Parts of the Main Window (Layout 0): Adjustment Window (Default)

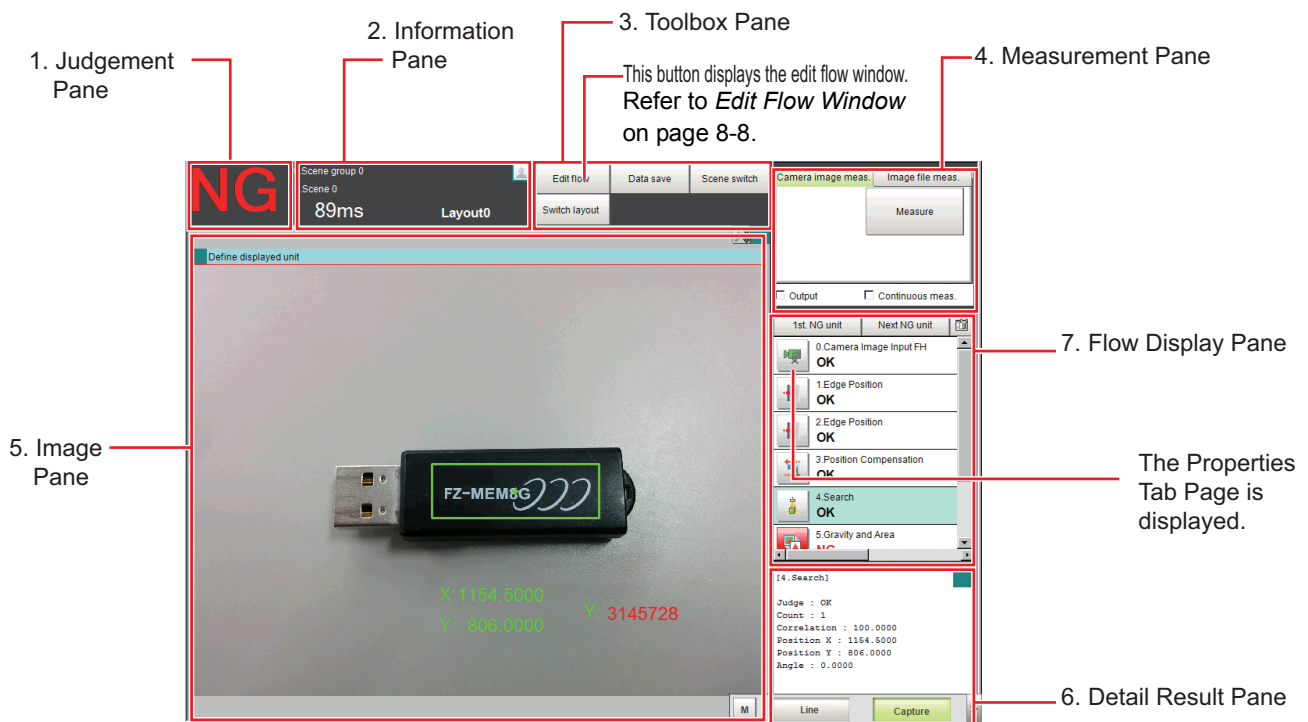

#### 1. Judgement Pane

- Overall Judgement Result

The overall judgment (OK/NG) for the scene is displayed.

This is the overall judgement result for the entire scene. If any processing unit that is reflected in the overall judgement returns NG, the overall result is NG.

\*1. The judgement results for individual processing units are displayed in the Detail Result Pane.

### 2. Information Pane

- Layout:  
The number of the currently display layout is displayed.
- Processing time:  
The time required for the measurement process is displayed.
- Scene group name and scene name:  
The scene group number and the scene number of the currently displayed scene are displayed.

### 3. Toolbox Pane

- [Edit flow]:  
This button starts the edit flow window that is used to edit flows. Refer to *Edit Flow Window* on page 8-8.
- [Data save]:  
This saves settings data to the flash memory in the Controller. If you make any changes to the settings, make sure to click this button to save the settings.
- [Switch scene]:  
This button switches between scene groups and scenes:
- [Switch layout]:  
This button switches the layout number.

### 4. Measurement Pane

- Camera image meas.:  
This button performs a test measurement on the Camera image.
- Image file meas.:  
This button re-measures saved images.
- Output:  
Select this option to output the measurement results of test measurements that are performed in the Adjustment Window. Do not select this option if you need to perform test measurements on the Sensor Controller but do not need to output the results externally.  
This setting menu is used for temporary setting changes while the Main Window is displayed. When the scene or layout is changed, the "Output" setting in the Layout setup is applied without saving the "Output" setting in the Measurement Pane. Use as appropriate for your application. Refer to *8-3-2 Setting the Behavior of Output Signals for Each Layout [Layout Settings]* on page 8-25.
- Continuous meas.:  
Select this option to continuously perform test measurements in the Adjustment Window. Select the [Continuous meas.] option and click [Measure] to repeatedly execute measurements.



## 5. Image Pane

This pane shows the measured image.

It also displays the selected processing unit name or the [Define displayed unit].

- Click on the left side of the processing unit name to display the Properties Dialog Box for the Image Pane.

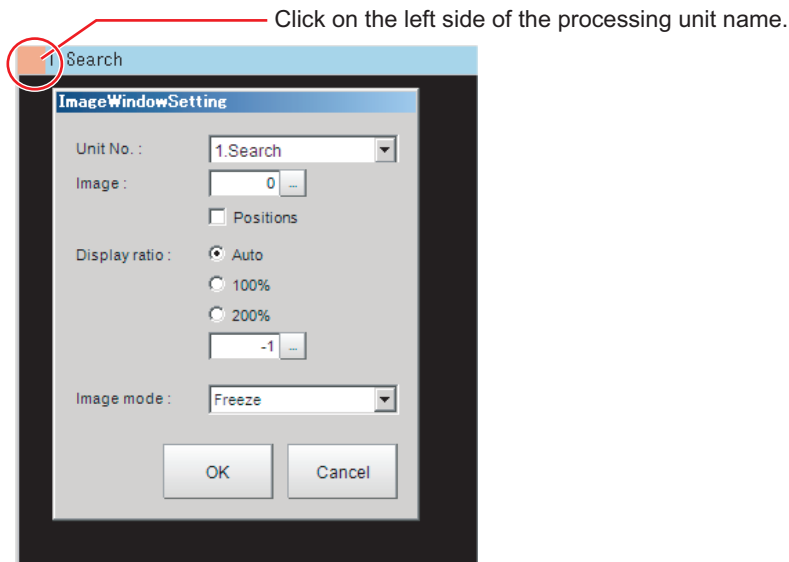

On this dialog box, you can change the image mode and other contents that are displayed in the Image Display Pane.

Refer to 3-2-7 *Changing the Image Mode and Other Display Contents* on page 3-24.

- Click the upper corner of the Image Display Pane to display the [Add Image Window] button and [Alignment] button. This allows you to display more than one pane side by side.

Refer to 8-3-1 *Arranging Window Elements (Layout Modification)* on page 8-14.

## 6. Detail Result Pane

This pane displays the results of test measurements.

The floating point number is rounded off to four digits after decimal point.

The floating point numbers that are saved as data will not be rounded off.

## 7. Flow Display Pane

This pane displays the contents of the measurement process (the processing that is set in the measurement flow).

Click the icon of any processing item to display the Properties Dialog Box to set processing item parameters and other settings.

You can use the following buttons to move to the next processing unit with an NG judgement result.

[1st NG unit]: Moves to the first processing unit with an NG judgement.

[Next NG unit]: Moves to the next processing unit with an NG judgement.

[] "Property setting" button: Displays the property setting window of selected processing unit.

## Edit Flow Window

The edit flow window is used to create measurement flows. You use the edit buttons to arrange processing units in a scene, or to add or delete units.

The right side shows the processing items that can be used as parts in the measurement flow. The left side shows the scene as the measurement flow.

When a measurement trigger is input, processing is executed in sequence starting from the top of the measurement flow.

Click the button for any processing item that is set in the measurement flow, or click the [Set] button to open the Properties Dialog Box.

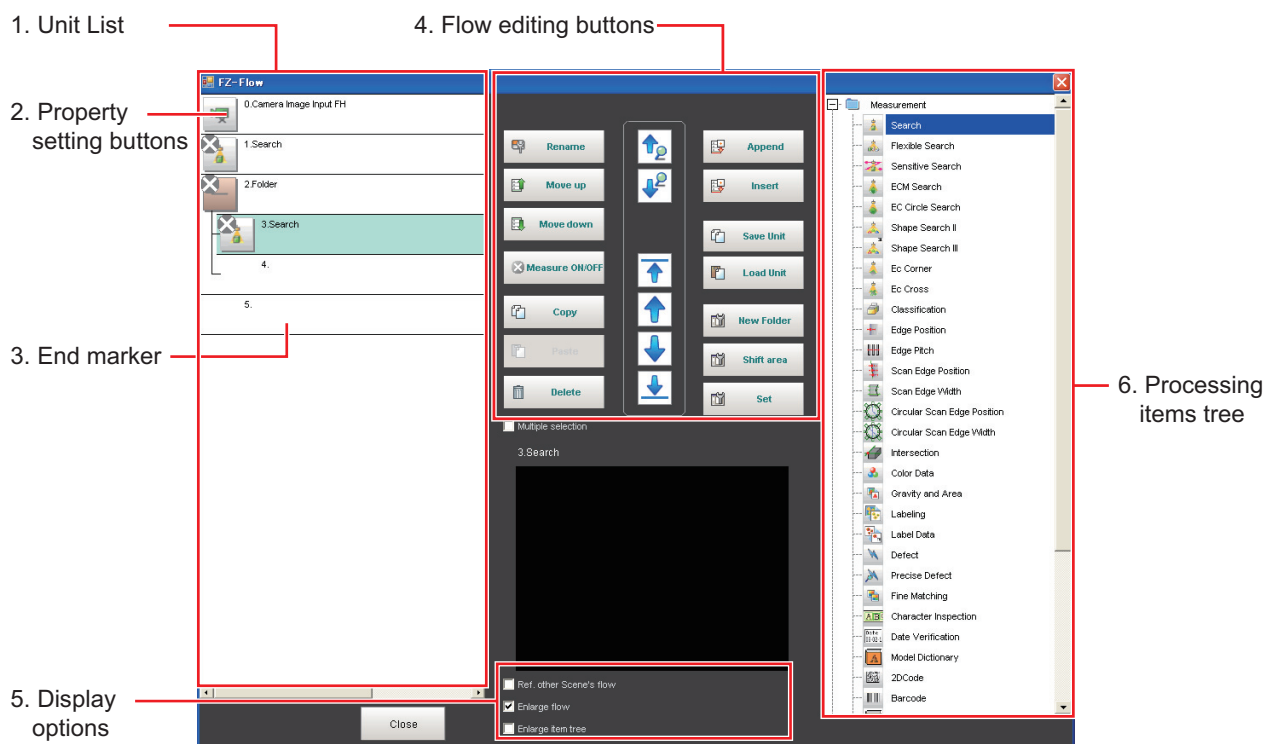

### 1. Unit List

The processing units included in the flow are displayed in a list.

You can create a flow for a scene by adding processing items to the unit list.

### 2. Property Setting Buttons

The Properties Dialog Box is displayed and allows you to make detailed settings.

### 3. End Marker

This marker indicates the end of the flow.

### 4. Flow Editing Buttons

You can use these buttons to change the order of processing units within the scene or to delete processing units.

Refer to *5-5-2 Editing Processing Units in a Scene* on page 5-24.

### 5. Display Options

- Enlarge flow  
When this option is selected, the Unit list flow (1) is displayed with large icons.
- Enlarge item tree  
When this option is selected, the processing item tree (6) is displayed with large icons.
- Ref. other Scene's flow  
When this option is selected, other scene flows within the same scene group can be referred to.

### 6. Processing Items Tree

This area allows you to select an item to add to the flow. The items are displayed in tree format that is organized by type.

Click the [+] button for each item to display the lower level items. Click the [-] button for each item to hide the lower level items.

When [Ref.other Scene's flow] is selected, the scene select box and other scene flows are displayed.

### 8-1-4 Main Window (Layout 1): Run Window (Default)

This window is used to perform actual measurements. The measurement results are output through the communications interfaces.

If the Controller is ready to perform measurements, the RUN signal turns ON.

When this window is displayed, the FH/FHV/FZ5 is ready to perform measurements.

If a measurement trigger is input from an external device, the FH/FHV/FZ5 begins execution of measurement processing according to the contents and sequence that is set in the measurement flow.



**Additional Information**

Use the following procedure to change to Main Window (layout 0).

Select [Switch layout] from the [Function] menu (default layout).

● **Names of the Parts of the Main Window (Layout 1): Run Window (Default)**

The functions of each display window are the same as for the Main Window (layout 0).

The Toolbox Pane and Measurement Pane that are displayed on the Main Window (layout 0) are not displayed.

(Layout modification can be used to change the layout.)

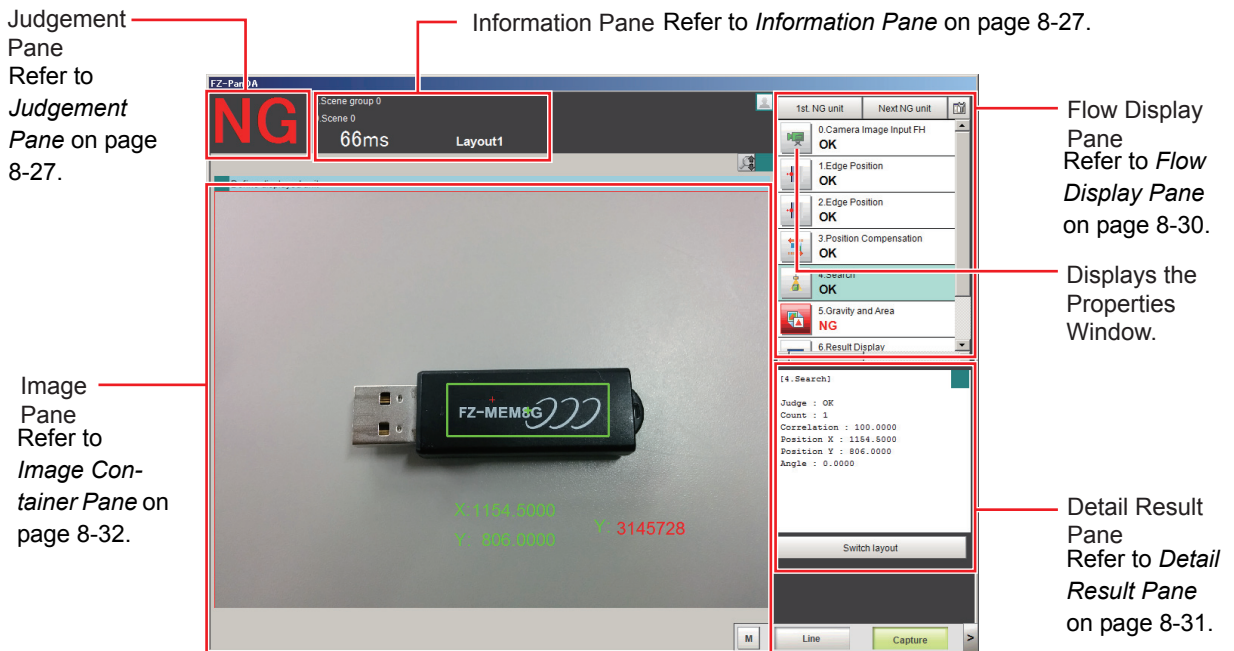

## 8-2 Adjustment Windows and Run Windows

After test measurement and remeasurement are performed on the Main Window (layout 0), check the measurement results. If there are problems, adjust the processing item setting values of the processing units. When the measurement results are stable, change to the Main Window (layout 1) and perform measurements. This section describes the adjustment windows and run windows.

### 8-2-1 Main Window (Layout 0): Adjustment Window (Default)

Layout 0 is set as an adjustment window by default. (This can be changed in Layout Modification Mode.)

The judgement result and measurement time for the entire scene are displayed.

You can overlay the measurement results on the Camera image.



Units with NG results are displayed in red.

Measurement results are displayed in text format.

Measurement Manager Bar  
This is displayed regardless of the layer that is displayed.

- [Capture]: Saves the contents that is displayed on the monitor as an image. Refer to 3-5 *Capturing Screen Images* on page 3-32.
- [LCD Off] (Displayed only with LCD-integrated Controllers.) Turns OFF power to the LCD monitor. Refer to 3-8 *Turning OFF the LCD* on page 3-41.
- [Line] (This is displayed only when the operation mode is set to Multi-line Random-trigger Mode.) This changes the line. Refer to *Multi-line Random-trigger Mode* on page 4-19.
- [Switch Screen] (This is displayed only when the operation mode is set to Non-stop Adjustment Mode.) This changes to the Non-stop Adjustment Mode Window. Refer to *Non-stop Adjustment Mode* on page 4-25.
- [M] This button opens the window to show the amount of memory and percentage of memory used. Refer to 3-4 *Checking the Memory Consumption and Percentage of Memory Used* on page 3-31.

## 8-2-2 Main Window (Layout 1): Run Window (Default)

Layout 1 is set as a run window by default. (This can be changed in Layout Modification Mode.)

The flow, detailed results, and tool box are displayed in the Control Area.

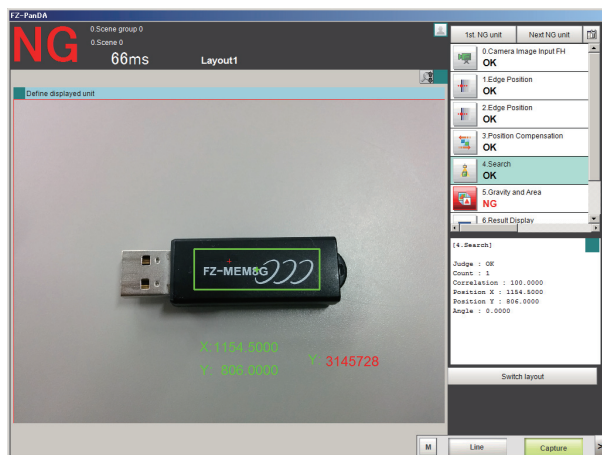

When processing takes a long time, it is necessary to check the processing items and setting values. The time required for measurement is also displayed with the measurement results, so use this for reference.

## 8-2-3 Main Window (Layout 1): Switching to the Run Window

- 1 In the Main Window (layout 0), click the [Switch layout] button.



- 2 In the [Switch layout] dialog box, select the layout number (layout 1 by default).  
The display changes to the Main Window (layout 1).



### Additional Information

- You can make settings so that the run window is displayed whenever the power supply to the Controller is turned ON.  
Refer to 4-2 *Setting the Status at Startup [Startup Settings]* on page 4-3.
- The lighting gradually gets darker if it is used for a long time, so adjust judgement conditions periodically.
- Without stopping the measurement, you can change judgement conditions for a processing unit set for a scene.  
Refer to 6-5-4 *Changing Judgement Conditions without Stopping Measurement [Simplified Non-stop Adjustment]* on page 6-35.

## 8-2-4 Main Window (Layout 1): Switching to the Adjustment Window

- 1 In the Main Window (layout 1), click the [Switch layout] button in the Toolbox Pane.

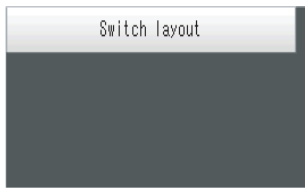

- 2 In the [Switch layout] dialog box, select the layout number (layout 0 by default).  
The display changes to the Main Window (layout 0).

## 8-3 Arranging Windows [Layout Functions]

### 8-3-1 Arranging Window Elements (Layout Modification)

Configuration elements for the Main Windows (called *window parts*) can be laid out and displayed anywhere. You can create a maximum of 9 Main Windows from layout 0 to layout 8.

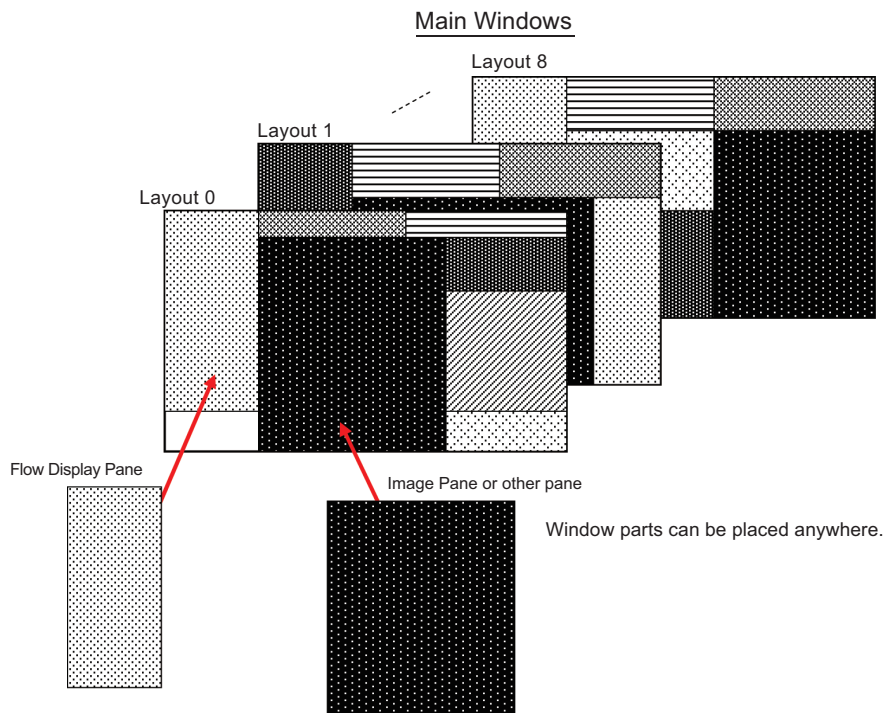

Each Layout Window is set as follows by default:

Layout	Default setting	Behavior of output signals	
		RUN signal output	Signal output of results
Layout 0	Layout 0 is set as an adjustment window.	OFF	OFF
Layout 1	Layout 1 is set as a run window.	ON	ON
Layouts 2 to 7	Layouts 2 to 7 are for user-defined purposes and are created as they are needed. By default, these layouts have the same settings as layout 0.	OFF	OFF
Layout 8	Layout 8 is set as a remote operation window. When an error occurs in Layout 8, error dialog appears as a text string in the Error Pane instead of in an error dialog box.	OFF	OFF

- You can use these layouts to create Main Windows that show only the information that the operator needs, such as a window that shows only the image and the OK or NG status for operation in the field.
- You can change the position and size of the image display, or the processing unit to be displayed for each product type, inspection, or measurement.



#### Important

If the operation mode is set to Multi-line Random-trigger Mode, create a layout for each line.



## Type of Window Parts to be Arrangeable and Changeable

The following windows can be placed in any place on a single layout. But more than one window with the same name cannot be placed on a single layout.

Window type	Name displayed at adding to a layout by changing layout
Error window	FZ_PanDA.ErrorWindow
Flow display window	FZ_PanDA.FlowWindow
Image container window	FZ_PanDA.ImageContainerWindow
Judgement display window	FZ_PanDA.JudgeWindow
Information display window	FZ_PanDA.InformationWindow
Label window	FZ_PanDA.LabelWindow
Measurement window	FZ_PanDA.MeasureWindow
Image file display window	FZ_PanDA.PictureWindow
Detailed result display window	FZ_PanDA.TextWindow
Tool window	FZ_PanDA.ToolWindow
Extended window part	For details, refer to 8-3-14 <i>Extended Window Parts</i> on page 8-40.

## Modifying Layouts

- 1 Select [Layout modification] from the [Window] menu in the Main Window for layout 0.

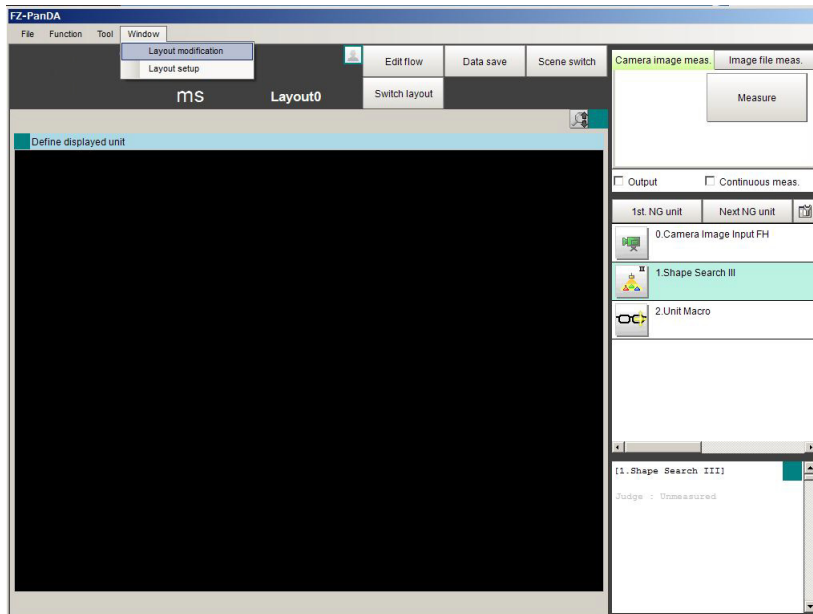

The display switches to Layout Modification Window.

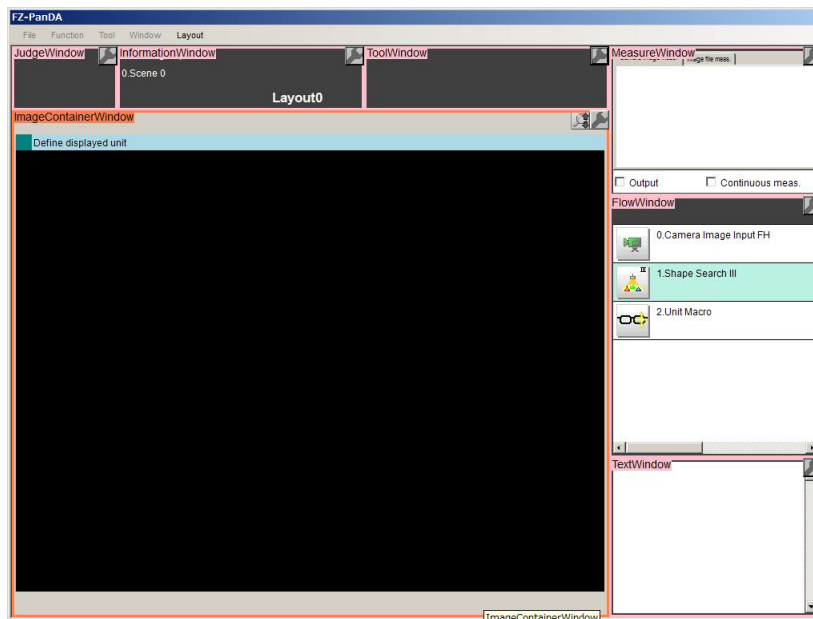

A  icon will appear on the upper right corner of each part. This indicates that the Layout Modification Mode is active.

In this state, you can display and arrange the layout of parts in the Main Window.

\*1. Normal menu and window operations are not available in Layout Modification Mode.

- 2** In the Layout Modification Window, click [Layout] on the menu.  
The following layout is displayed.

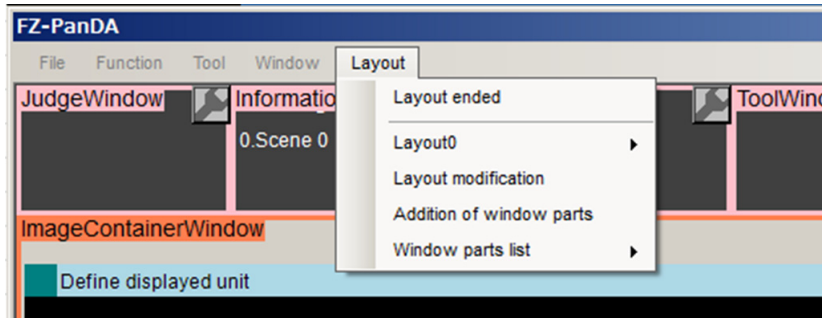

Layout	Description
Layout ended	Ends the layout modification.
Layout 0	Displays the selected layout number. When clicking it displays the Layout modification sub menu. In the sub menu, switching layouts and changing the name of a layout can be done.
Layout modification	Displays the Layout modification dialog. In the dialog, the display settings of the selected layout can be modified.
Addition of window parts	Displays the Addition of window part dialog. With it, a window that is not displayed in the standard mode can be added.
Window parts list	Displays the current displayed window list. When clicking the name in the list, the background of the selected window will change the color from pink to orange.

### ● Layout 0 (Layout switching)

When clicking it, the following sub menu is displayed. The current layout is checked.

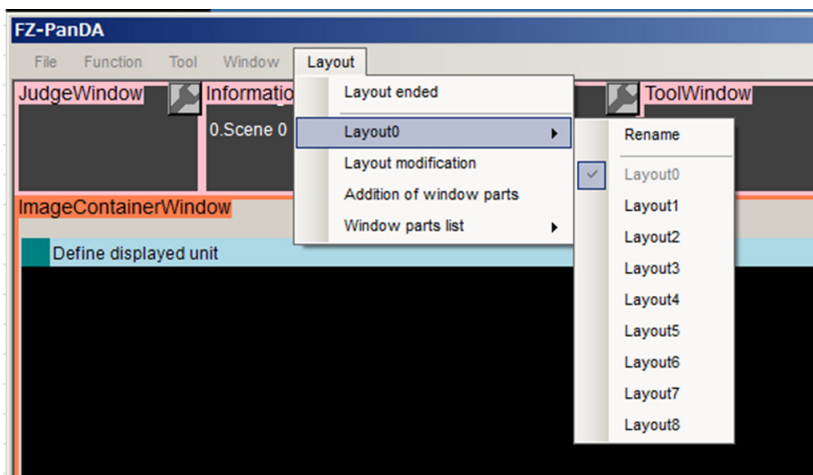

When changing the layout name, click [Rename]. The Rename dialog box is displayed. Input a name you want to set to the layout and click [OK].

When switching layouts, click the desired layout in the list.

## ● Layout modification

When clicking it, the following Layout modification dialog is displayed.

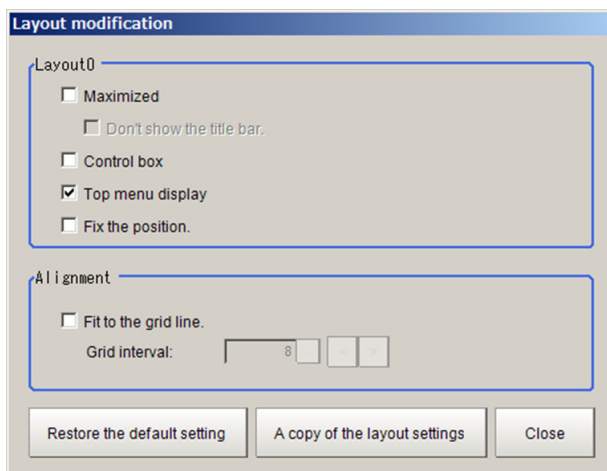

Setting Item	Setting value [Factory default]	Description
Layout number	---	Displays the layout number currently being edited.
Maximized	<ul style="list-style-type: none"> <li>[Unchecked]</li> <li>Checked</li> </ul>	<p>This function is exclusively for the FH series sensor controller. Specifies whether or not to always display the Main Window at its maximized state.</p> <p>Checked: The Main Window will be displayed in its maximized state on the current display. This window cannot be moved.</p> <p>Unchecked: The Main Window will be set to the size and position just before it was maximized.</p>
Don't show the title bar	<ul style="list-style-type: none"> <li>[Unchecked]</li> <li>Checked</li> </ul>	<p>This option is available when the [Maximized] is checked.</p> <p>Checked: The title bar will be hidden.</p> <p>Unchecked: The title bar will be displayed.</p>
Control box	<ul style="list-style-type: none"> <li>[Unchecked]</li> <li>Checked</li> </ul>	<p>This function is exclusively for the FH series sensor controller. Specifies whether or not to display a Minimize Button and a Close Button in the Main Window.</p> <p>Checked: A Close button and Minimize button will be displayed in the upper right corner of the Main Window.</p> <p>Unchecked: The Close button and Minimize button in the upper right corner of the Main Window will be hidden.</p>
Top menu display	<ul style="list-style-type: none"> <li>Unchecked</li> <li>[Checked]</li> </ul>	<p>Specifies whether or not to display the main menu at the top of the Main Window.</p> <p>Checked: A menu will be displayed at the top of the window.</p> <p>Unchecked: The menu at the top of the window will be hidden, and changes to the layout will no longer be allowed.</p>
Fix the position	<ul style="list-style-type: none"> <li>[Unchecked]</li> <li>Checked</li> </ul>	<p>Specifies whether or not to fix the Main Window.</p> <p>Checked: The Main Window position is fixed.</p> <p>Unchecked: The Main Window position is not fixed.</p>

Setting Item	Setting value [Factory default]	Description
Alignment		Sets the layout position.
Fit to the grid line	<ul style="list-style-type: none"> <li>• [Unchecked]</li> <li>• Checked</li> </ul>	Sets whether or not the grid lines are displayed on the Main Window by a pixel unit when the Layout modification is set.  Checked: The grid lines will be displayed on the Main Window.  The window part can be changed its position and size per grid.  Unchecked: The grid lines will be hidden.
Grid interval	2 to 200 [8]	This option is available when [Fit to the grid line] is checked.  Sets the grid size. Unit: pixel
Restore the default setting		The layout for the selected layout number is restored to the default settings.
A copy of the layout settings		Other layout is copied to the layout currently edited.
Close		Ends the Layout Modification Mode.

### ● Addition of window parts

When clicking it, the following window is displayed.

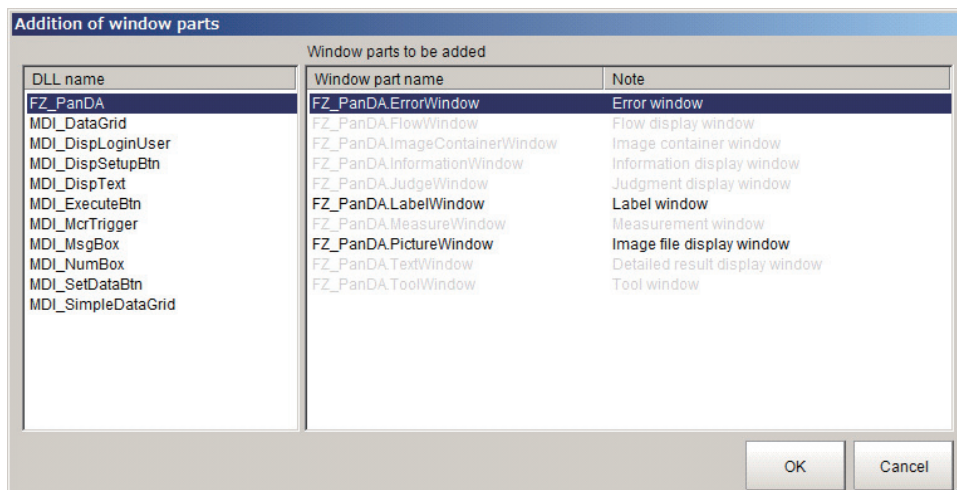

Item	Description
DLL name	Displays a list of PanDA. Exe and DLL files registered as a window part. When selecting it, the registered window part list and the description will be displayed.
Window part name and Note	Displays the window part name and the description.
OK	When clicking, the selected window part will be placed on the layout screen.
Cancel	Discards edited contents and closes this window.

### ● Window parts list

When clicking it, symbol name for registered window parts is displayed.

The background color of the name of a selected window part is changed from pink to orange and the window part is displayed in forefront.

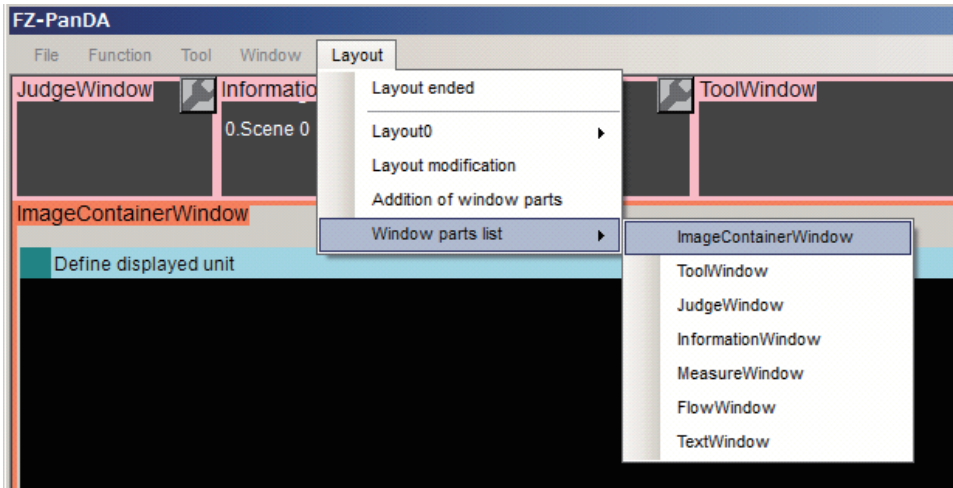

### ● Right-click Menu 1

The following shortcut menu is displayed when right-clicking on window parts.

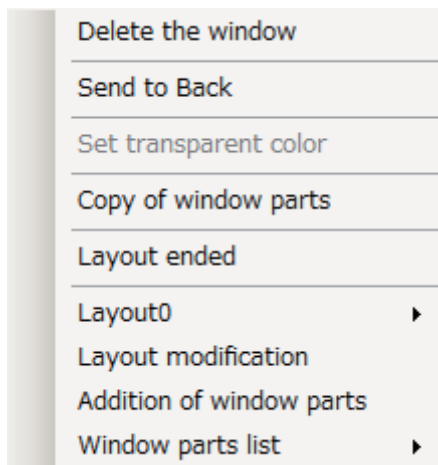

Item	Description
Delete the window	Deletes a selected window part.
Send to Back	Moves a selected window part to the rearmost face.
Set transparent color	Displays the "Set transparent color" dialog.
Copy of window parts	Copies a window part if the window part can be placed more than one. If the window part cannot be copied, a message dialog box appears.
Layout menu	Same as [Layout] dropdown menu list.

## ● Right-click Menu 2

The following shortcut menu is displayed when right-clicking on a place where no window parts is placed.

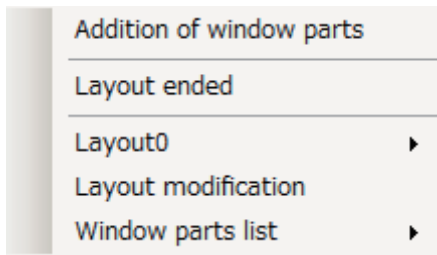

### Additional Information

The main menu at the top of the Main Window disappears when the layout setting is terminated after switching to a layout (Layout 1 at default setting) without the main menu. To re-display the main menu, follow the steps below.

- (1) Right-click to display the shortcut menu and click [Layout modification].
- (2) Check “Top menu display” on the “Layout modification” dialog box.



### Important

- The setting of [Maximized] applies only to the FH series Sensor Controller.  
With the FZ5 series Sensor Controller, the Main Window is always displayed at the maximum size regardless of the setting of [Maximized].
- The setting of [Control box] applies only to the FH series Sensor Controller.  
With the FZ5 series Sensor Controller, the Minimize Button and Close Button are always hidden in the Main Window regardless of the setting of [Control box].

## ● Common Operations for Window Parts

- Click inside a window part and drag it to change its position.
- Click the outer edge of a window part and drag it to change the size of the part.  
For FZ5, drag the icon in the lower right corner of a window part.
- Click the  icon that appears on the upper right corner of any window part to open the settings dialog box for that part.
- The grid line is displayed when you set Alignment.  
Each window part can have its size and position adjusted using the grid.

## ● Adding Window Parts

- 1 Click [Layout] in the menu or right-click and select [Addition of window parts] from the dropdown menu or shortcut menu displayed. “Addition of window parts” dialog box is displayed.

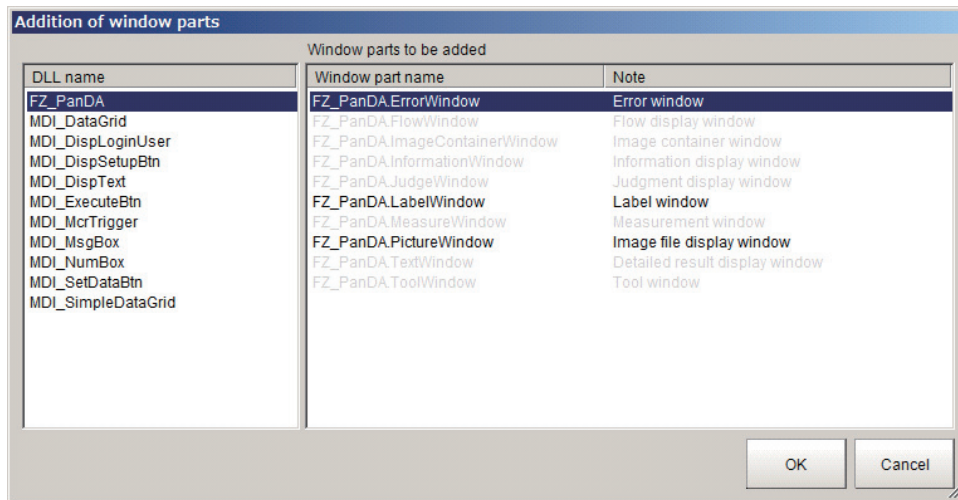

- 2 Select a window part to add.
- 3 Click [OK].  
The selected window part is added to the window.

## ● Deleting Window Parts

- 1 Select a window part to delete.
  - For FH series/FZ5-800/1100/1200 series
- 2 Click [Layout] in the menu or right-click on the window part and select [Delete the window] from the drop down menu or shortcut menu displayed.  
The selected window part is deleted.
  - For FZ-5L series/FZ5-600 series
- 3 Click  in the upper right corner of the window part. The selected window part is deleted.

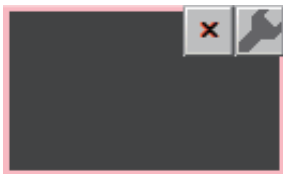



## ● When Setting a Transparent Color to Window Objects

The following window objects can be set a transparent color.

The transparent color portion on a window object can be superimposed on other window object.

- Label window
- Image file display window
- Data grid window
- Text display window
- Simple data grid window

**1** Right-click on the window object and click [Set transparent color].

The “Set transparent color” dialog is displayed.

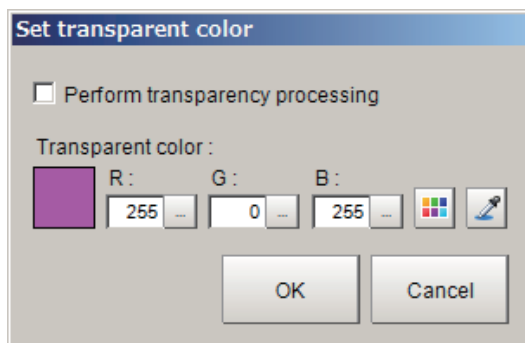

**2** Set a transparent color.

Setting item	Setting value [Factory default]	Description
Perform transparency processing	<ul style="list-style-type: none"> <li>• [Unchecked]</li> <li>• Checked</li> </ul>	Checked: Performs the transparent processing. Contents in the background window object can be displayed via the set transparent color part on the foreground window object.
Transparent color	R: 0 to 255 [255] G: 0 to 255 [0] B: 0 to 255 [255]	There are two ways to set the color. 1: Enter R, G, and B with numerical value. 2: Drag and drop  on a desired color. The dropped place's color will be set into R, G, and B.

**3** Click [OK].

## ● Restoring a Layout to its Default Settings

- 1 Select the layout number to restore to its default settings
- 2 Click [Layout] in the menu or right-click on the window part and select [Layout modification] from the dropdown menu or shortcut menu displayed. “Layout modification” dialog box is displayed.

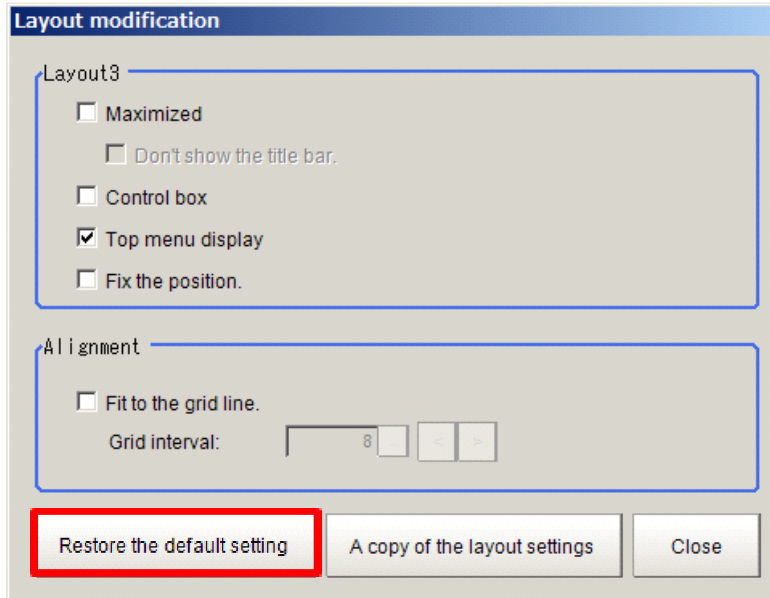

- 3 Click [Restore the default setting].

## ● Exiting Layout Modification Mode

- 1 Click [Layout] in the menu or right-click on the window part and select [Layout ended] from the drop down menu or shortcut menu displayed. Close Layout Modification Window and return to the Main Window.

## ● Changing the Layout Number from a Layout with a Hidden Top Menu

When you click [Layout ended] on a layout where the top menu display is hidden, the [Switch layout] button will automatically appear under the Detail Result Pane. Click the [Switch layout] button and switch to a layout number where the “Top menu display” option is selected in the “Layout modification” dialog box.

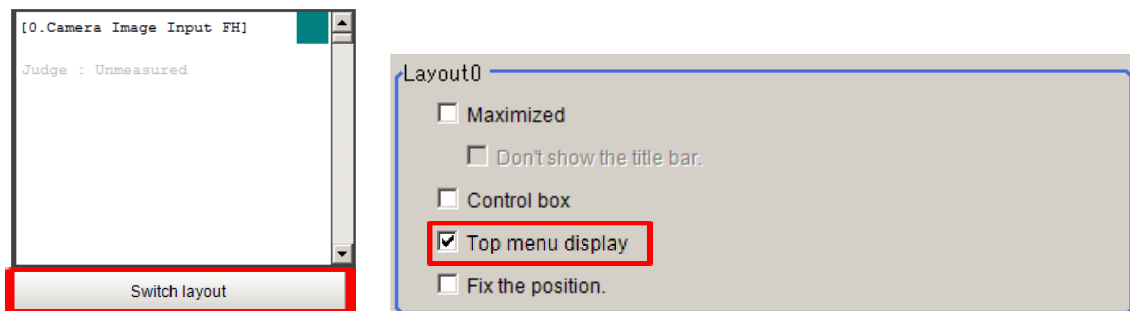

## Saving the Layout in the Controller or a File

- **Saving the Layout in the Controller**

After you end Layout Modification Mode, click the [Data save] button.

Restart the Sensor Controller to reflect the layout modifications that were saved.

- **Saving the Layout as a file**

Select [Save to File] from the [Function] menu. Under [Settings data], set the [Data to be saved] to [System data] or [System + Scene group 0], specify the destination, and then click the [OK] button.

### 8-3-2 Setting the Behavior of Output Signals for Each Layout [Layout Settings]

For each layout, you can set the behavior of output signals after the layout is changed.

- 1 Select [Layout setup] from the [Window] Menu for the main window for layout 0.
- 2 The following [Layout setup] dialog box is displayed.

Set the name for layouts 0 to 8, and whether to use the RUN signal output and external output signals.

Layout	RUN signal output	Output
Layout0	<input type="checkbox"/>	No Control
Layout1	<input checked="" type="checkbox"/>	ON
Layout2	<input type="checkbox"/>	No Control
Layout3	<input type="checkbox"/>	No Control
Layout4	<input type="checkbox"/>	No Control
Layout5	<input type="checkbox"/>	No Control
Layout6	<input type="checkbox"/>	No Control
Layout7	<input type="checkbox"/>	No Control
Layout8	<input type="checkbox"/>	No Control

OK Cancel

Setting item	Setting value [Factory default]	Description
Layout		Layout name (up to 32 characters)
RUN signal out	<ul style="list-style-type: none"> <li>• [Unchecked]</li> <li>• Checked</li> </ul>	The RUN signal is turned on when the box is checked.
Output	<ul style="list-style-type: none"> <li>• [Not control]</li> <li>• OFF</li> <li>• ON</li> </ul>	<p>Sets whether or not to output the execution results of the Result output processing units.</p> <p>Not control: The state of the outputs that were in effect before the layout was changed is retained. If [Output] is selected just before the layout is changed, the outputs stay ON, and if [Output] is not selected, the outputs stay OFF.</p> <p>ON: Data is output when a Results output processing unit is executed in the measurement flow during execution of a measurement.</p> <p>OFF: Data is not output even when a Results output processing unit is executed in the measurement flow for a measurement.</p>

The operation of the output signals in each state is as follows. Set it as necessary.

State	Layout 0, 2 to 7 displayed *1	Just after switch- ing scenes /lay- outs	At startup
Output condition for output signal	Follow the "Output" setting in the measurement window.	Follow "RUN signal output" on "Layout setup" dialog.	Follow the setting of [Startup layout] of [Basic] on [System Settings] in [Tool] menu. For the selected layout in the "Layout setup" dialog, the output is not performed when the "Output" setting is "No Control".

\*1. In the default setting, the check box of the "RUN signal output" for layout 1 and 8 is not displayed.

### 8-3-3 Switching Layout Numbers in the Main Window [Layout Switching]

You can change the layout in the Main Window to the layout number that was set in Layout Modification Mode.

Use this when you need to work with more than one layout.

- 1** Select [Switch layout] on the [Function] menu or from the tool buttons.
- 2** Select the layout number to switch to and click the [OK] button to close the [Switch layout] dialog box.

Setting item	Setting value [Factory default]	Description
Layout number	0 to 8	Layout number



#### Additional Information

It is also possible to switch the Layout number with a communication command.

### 8-3-4 Judgement Pane

This pane shows the overall judgement result. There are no parameters that can be set.

### 8-3-5 Information Pane

This pane shows various information about the measurement and scene.

The following elements are displayed.

- Processing Time
- Layout Number
- Scene Group Number: Scene Group Name
- Scene No.: Scene Name
- Logging Errors
- PLC Link Errors

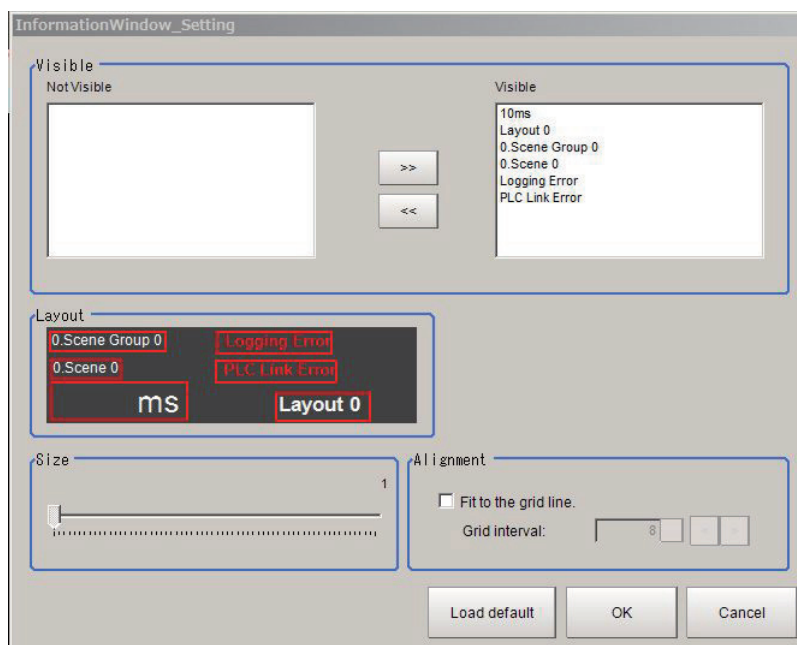

Setting item	Setting value [Factory default]	Description
View	[All visible]	Layout Number, Processing Time, Scene Group Number + Scene Group Name, Scene No. + Scene Name, Logging Error, PLC Link Error
Layout	---	Click the display item to change its size. The position can be changed by dragging. Setting the Alignment, the grid lines will be displayed
Size	1 to 64	The default size depends on the item.
Load default	---	Restores the default status.
Alignment		Sets this function to adjust layout position.
Fit to the grid line	<ul style="list-style-type: none"> <li>• [OFF]</li> <li>• ON</li> </ul>	Sets whether the grid lines are displayed on the Main Window by a pixel unit when the Layout modification is set. ON: The grid lines will be displayed on the Main Window. The window part can be changed its position and size per grid. [OFF]: The grid lines will be hidden.
Grid interval	2 to 200 [8]	Sets the grid size. Unit: pixel

### 8-3-6 Toolbox Pane

This pane shows the tool buttons.

The following elements are displayed.

- [Edit flow] button
- [Data save] button
- [Switch scene] button
- [Switch layout] button

Setting item	Setting value [Factory default]	Description
Add button		Adds one button per click. The sub menus of File menu, Function menu, and Tool menu can be assigned to buttons.
Button size	16 x 999 [102 x 40]	Sets the size of each button in pixels.
Buttons/columns	1 to 32 [3]	Sets the number of buttons to display per column.
Optimize the button		Sets the height and width of buttons based on the window size divided by the number of buttons. One-click adjusts the size of all buttons.
Delete button		Click a button you want to delete and then select [Delete] in the sub menu.

The following is an example for adding [Clear measurement] button in the Toolbox pane.

- 1 In Layout modification mode, click the  icon in the upper right corner of the Toolbox pane. The "ToolForm\_setting" dialog box is displayed.

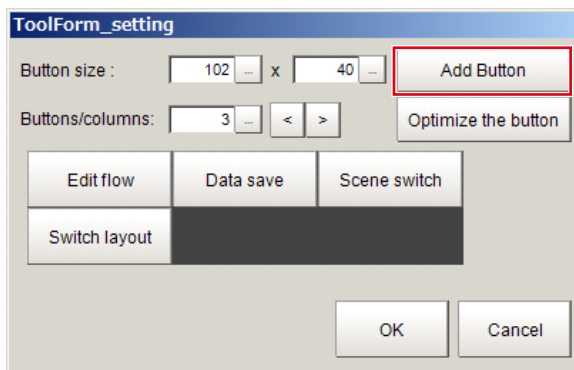

- 2 Click [Add Button].  
A button is added in the dialog.

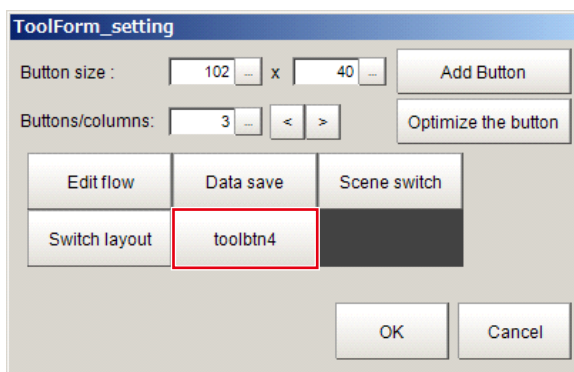

- 3** Click the added button.  
The following shortcut menu is displayed.

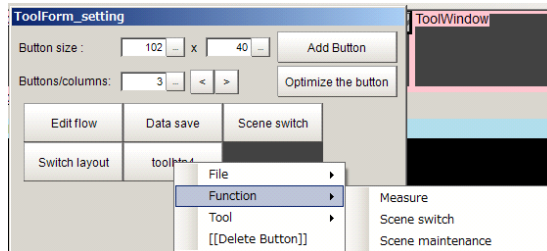

- 4** Select “Clear measurement” on “Function”.

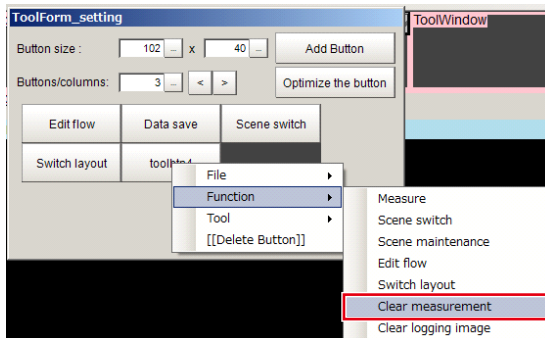

The “Clear measurement” button is added to the Toolbox pane.

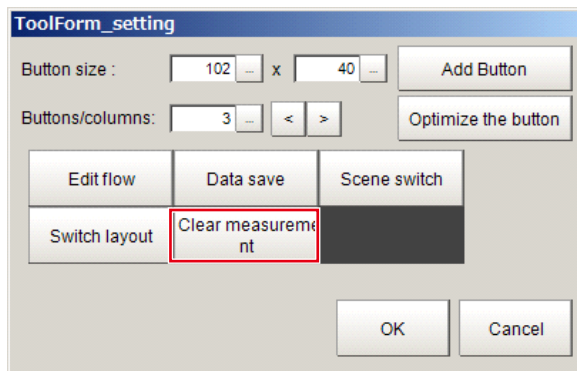

### 8-3-7 Measurement Pane

This pane is for measuring and re-measuring. The following elements are displayed. There are no editable elements.

- [Camera image meas.] tab page: [Measure] button
- [Image file meas.] tab page: [Selection image] button, [Re-meas.] button, [Auto Re-meas.] check box, and the [Judgement result monitor] check box
- [Output] check box
- [Continuous meas.] check box

### 8-3-8 Flow Display Pane

This pane shows the measurement flow.

The following elements are displayed.

- [1st. NG unit] button
- [Next NG unit] button
- [] "Property setting" button
- Measurement flow list

## Changing the size of the Flow Display Pane

Use the following procedure if the type of settings dialog box to display when you click a processing unit icon is set to the Simplified Non-stop Adjustment Mode:

- 1** In Layout Modification Mode, click the  icon in the upper right corner of the Flow Display Pane.



- 2 The following settings dialog box is displayed. Set the following settings.

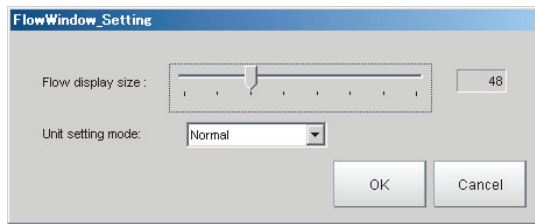

Setting item	Setting value [Factory default]	Description
Flow display size	16 to 128 [48]	Sets the size of the Flow Display Pane. The unit is in pixels.
Unit setting mode	<ul style="list-style-type: none"> <li>• [Normal]</li> <li>• Simplified non-stop</li> <li>• Nothing</li> </ul>	<p>Specifies the type of item settings dialog box to display when you click on a processing unit icon.</p> <p>Normal: Displays a normal settings dialog box.</p> <p>Simplified non-stop: Displays the Simplified Non-stop Adjustment Mode.</p> <p>Nothing: No settings dialog box is displayed.</p>

### 8-3-9 Detail Result Pane

This pane gives detailed measurement results in text format for the selected processing unit in the measurement flow.

The following elements are displayed.

- Processing unit number, Item name
- Judgement

There are no parameters that can be set.

### Specifying the Unit Number in the Detail Result Pane

- 1 Click the upper right corner of the Detail Result Pane.

Click the upper right corner.



- 2 The following dialog box is displayed. Use this to specify the display mode for the Detail Result Pane.

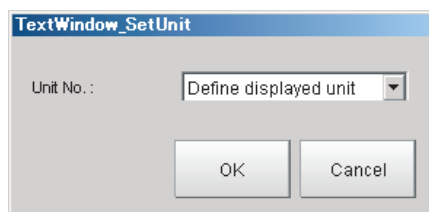

Setting item	Setting value [Factory default]	Description
Unit No.	<ul style="list-style-type: none"> <li>[Define displayed unit]</li> <li>Unit No.</li> </ul>	<p>Define displayed unit: The detail result for the selected unit on the flow display is displayed. If the unit selected on the flow display is changed, detail result shown also changes according to the setting. If Flow Display Pane is selected as hidden in Layout modification settings, the current settings for the Flow Display Pane are maintained.</p> <p>Unit No.: The detail result of the selected unit is displayed regardless of the unit selected on the Flow Display Pane. If Flow Display Pane is selected as hidden in Layout modification settings, the current settings for the Flow Display Pane are maintained.</p>

### 8-3-10 Image Container Pane

You can add image windows and change the layout of them in Image Container Pane.

#### Limiting the Number of Image Panes Assignable to Each Layout

When adjusting the number of Image panes to use, a number is assigned to each Image pane. The number goes up as more Image pane is added. You can limit the count of Image panes by specifying a range of the assigning numbers.

- 1 In Layout Modification Mode, click the  icon shown on the upper right corner of the Image Container Pane.
- 2 A window to specify the range of the number of Image panes appears. Set up as follows.

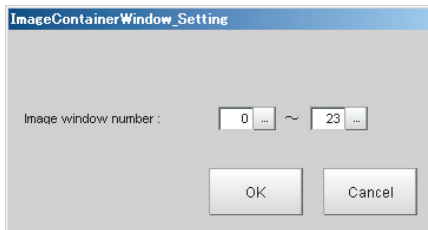

Setting item	Setting value [Factory default]	Description
Image window number	Layout 0 to 7: [0] to [23] Layout 8: [24] to [31]	Layout 0 to 7: Up to 24 Image panes within the Image Container pane can be added.  Layout 8: Up to 8 Image panes within the Image Container pane can be added.

#### To add image windows

Complete the layout modification, and then click the upper right corner of the Image Container Pane.

Click the upper right corner.



A button to adjust the display settings of the Image Container Pane appears on the lower left corner of the image window.

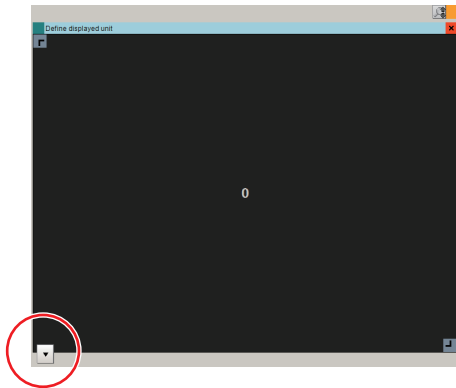

**3** Click the button.

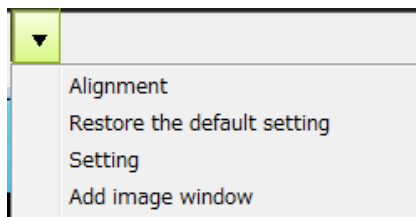

Menus will be displayed where you can adjust the following settings.

Setting item	Setting value [Factory default]	Description
Alignment		Aligns image windows at even intervals when clicking.
Restore the default setting		Restores default settings for the position, grid, and aspect ratio of the image window.
Setting	<ul style="list-style-type: none"> <li>• Alignment</li> <li>• Aspect ratio</li> </ul>	Adjusts the layout of the image pane. Alignment: Alignment to the grid Aspect ratio: Fix the aspect ratio
Add image window		Adds an image window. An image pane and an image pane number will be added as display object per click.

**4** Click [Add image window]. An image will be added in the Image Container Pane.

- 5** The size and position of the image panes can be adjusted by dragging them.

To delete an image pane, click the  button at the upper right corner of the image pane.

## Displaying Multiple Images Aligned at Even Interval

Click [Alignment]. Then, image panes will be displayed in the order of the image pane number.

Example: When aligning image pane 0 to 5

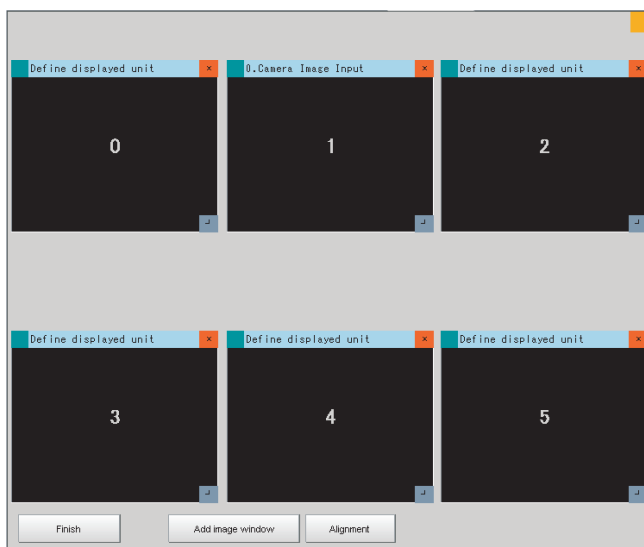

## Showing Grid and Fixing the Aspect Ratio of the Image Pane

Image panes can be moved and scaled up/down by fitting to the grid. The aspect ratio of the image pane can be fixed.

- 1** Click [Setting] to adjust settings shown in the following image.

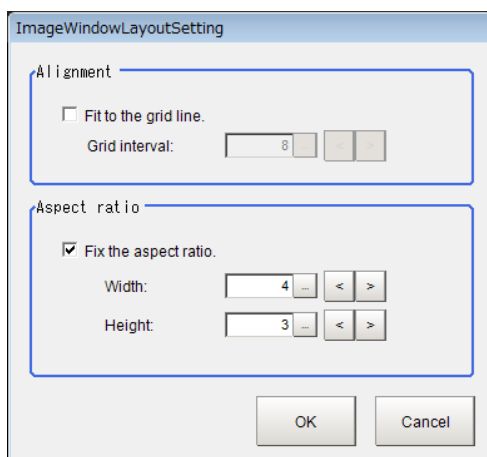

Setting item	Setting value [Factory default]	Description
Alignment		
Fit to the grid line	<ul style="list-style-type: none"> <li>• [Unchecked]</li> <li>• Checked</li> </ul>	<p>Selects whether or not to show the grid in the Image Container Pane.</p> <p>Checked: The grid will be shown. The size and position of the window parts will be adjusted according to the grid.</p> <p>Unchecked: The grid will be hidden.</p>
Grid interval	2 to 200 [8]	Sets the grid size in pixels.
Aspect ratio		
Fix the aspect ratio	Height: 1 to 9999 [3] Width: 1 to 9999 [4]	<p>Sets whether or not to fix the aspect ratio of image pane. The aspect ratio can be adjusted according to that of connected camera.</p> <p>Checked: The size will be changed with fixed aspect ratio.</p> <p>Unchecked: The size will be changed without fixing the aspect ratio.</p>
	<ul style="list-style-type: none"> <li>• [Unchecked]</li> <li>• Checked</li> </ul>	



### Important

- Part of image panes can exceed the Image Container Pane horizontally. They cannot entirely be positioned outside the Image Container Pane. The upper left part of the image pane will always stay inside the Image Container Window. No portion of image panes can be positioned outside the Image Container Pane vertically.
- Available Image Pane numbers differ for the layouts 0 to 7 and for the layout 8. Therefore, change of Image Panes for the layout 0 to 7 does not apply to the layout 8.

## 8-3-11 Error Pane

This pane shows errors, such as Camera connection errors.

If you add an Error Pane to a layout and an error occurs that normally causes an error dialog box to appear, an error string will appear in the Error Pane.

This is useful for remote operation or situations where an error dialog box would be difficult to close.

The latest error string (error message) is displayed on the top line of the error pane.

Also the error pane can display the error messages of up to 100.

The Error Pane is assigned to layout 8 by default.



### Additional Information

The Error Pane displays error messages for the following errors.

- System errors
- Fan or voltage errors
- Camera connection errors
- Changes made to the connected Camera
- Camera overcurrent detected
- Image logging disk write errors
- Output control timeout errors (parallel I/O, PLC Link, or EtherNet/IP)
- PLC Link communications errors
- Parallel I/O overcurrent detected
- Settings data load errors
- Settings data transfer errors
- Output timeouts (EtherCAT)
- Output buffer errors (EtherCAT)

## Clearing the Error Display

- 1 In the state where you have exited layout modifications, click the upper left corner of the Error Pane.

Click the upper left corner.



- 2 The following dialog box is displayed. Click the [Clear] button.

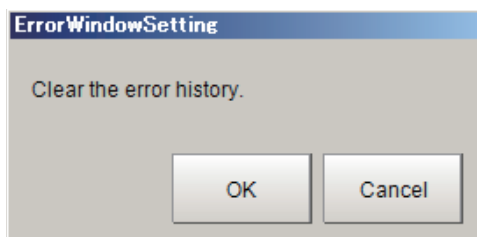

- 3 Click the [Close] button on the settings dialog box to close the dialog.

## 8-3-12 Image File Display Pane

The image file display is automatically adjusted to the size of the Image file display pane and cannot be changed.

You can register an image file, and select a registered image to display in the layout.

By default, this pane is not displayed.

### Registering an Image File (Bitmap) such as a Logo

- 1 In Layout Modification Mode, click the  icon in the upper right corner of the Image file display window object.

The settings dialog box for the Image file display pane will be displayed.

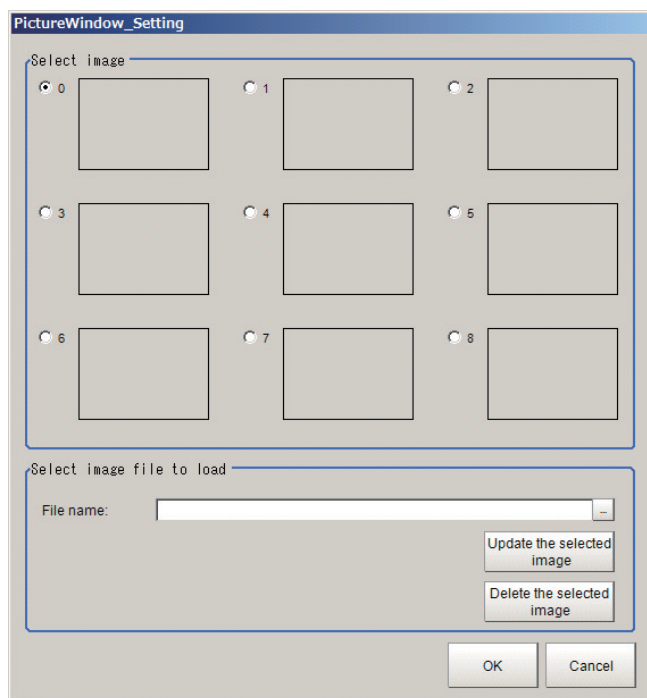

- 2 To register an image, select 0 to 8 in the image selection area.
- 3 Click [...] to the right of the File name in the load image file selection area. FileExplorer is displayed.
- 4 Select the bitmap file to display, and then click the [OK]. This loads the image data from the file and saves a copy in the sensor controller. However, at this point, the selected image is not reflected in the display.
- 5 Click the [Update the selected image]. At this time, the selected image is displayed in the selected number portion within the image selection area.
- 6 If there are multiple images to register, then repeat steps 2 to 5.
- 7 Additionally, to delete registered images, select the image to delete from the image selection area and then click the [Delete the selected image].

## Selecting an Image File (Bitmap) such as a Logo

- 1 In Layout Modification Mode, click the  icon in the upper right corner of the Image file display pane object.

The settings dialog box for the Image file display pane will be displayed.

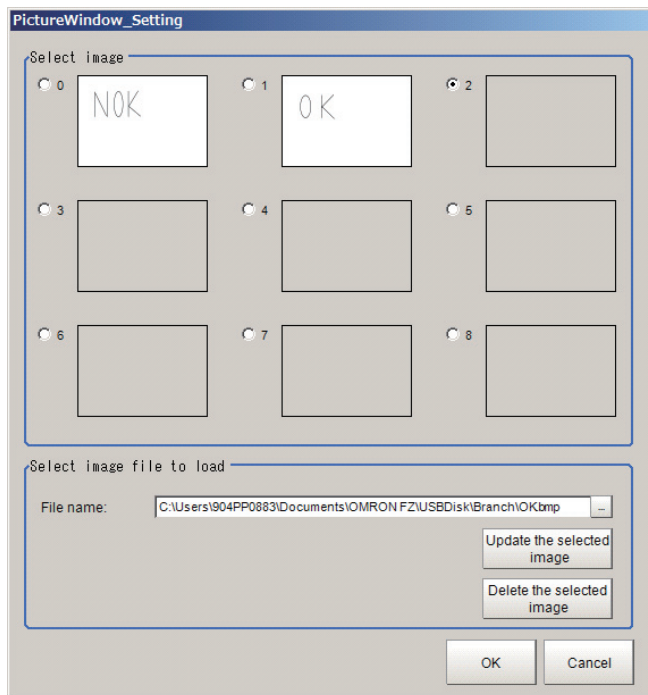

- 2 Select the image to display from 0 to 8 in the image selection area.
  - 3 Click [OK].
- The image with the selected number will be displayed in the pane.  
The image file will be fit to the height and width of the Image File Display Pane.



### Additional Information

- Image will be fit to the upper left corner of the Image File Display Pane. The size and position of the image cannot be changed.
- The image is loaded and displayed when launching the FH Sensor Controller, when registering the Image File Display Pane, or changing the Pane settings.
- The same image can be shared across multiple layouts by selecting the same image selection number in multiple layouts.
- If the sensor controller settings are initialized, then images saved within the sensor controller will be deleted.



### Important

Image file size that can be displayed in the Image File Display Pane is 1MB or less. If the size of an image file is over 1 MB, the image will not be correctly displayed in remote operation.



## 8-3-13 Label Pane

This pane is for displaying the title and other text.

By default it is not displayed.

### Displaying Characters

- 1 Select and move to the desired window from the Layout modification screen.
- 2 Right-click in an area outside the window and then click "FZ\_PanDA.LabelWindow."
- 3 Click the  icon in the upper right corner.
- 4 The settings screen below will be displayed. Make the following settings.  
The Label Window is a window to display letters such as titles.

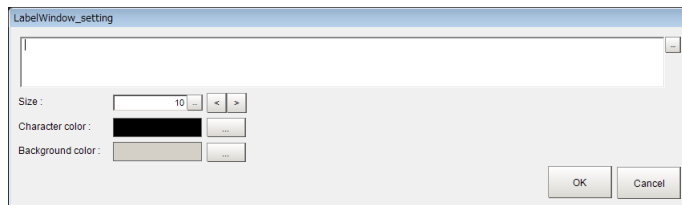

Setting item	Setting value [Factory default]	Description
Word to display	0 to 255 characters	Displays character strings.
Size	5 to 50 points [10]	Specifies the font size of the displaying words.
Character color	16,770,000 colors [Black]	Specifies the color of characters by RGB.
Background color	16,770,000 colors [Gray]	Specifies the color of characters by RGB.



#### Important

In the Label Window, only characters in the language selected under the System Settings are available.

Multi-lingual is also supported. For details, refer to *3-2-2 Inputting Text* on page 3-7.

### 8-3-14 Extended Window Parts

The FH series uses extended window parts that are different to those window parts that can be displayed in the existing layout.

Extended window parts reference target external DLLs, and can be added by selecting parts. The procedure to add these is the same as for adding window parts.

For details, refer to *Adding Window Parts* on page 8-22.

You can layout extended window parts in the main window.

Additionally, the text input area of extended window parts provides multi-lingual support.

For details, refer to *3-2-2 Inputting Text* on page 3-7.



#### Important

Extended window parts have the following restrictions.

- You can not place multiple extended window parts with the same name within a single layout.
- Extended window parts can only be used in standard mode and multi-line random trigger mode. These will not operate during double speed multi-input mode and non-stop adjustment mode. For details, refer to *4-4-1 Setting the Operation Mode* on page 4-13.

Extended window parts that can be placed are as follows.

You can place the following panes anywhere on a single layout.

Pane	Name displayed when a pane is added
Data grid window	MDI_DataGrid.dll
Login account display window	MDI_DispLoginUser.dll
Settings dialog box display button window	MDI_DispSetupBtn.dll
Text display window	MDI_DispText.dll
Custom dialog display button window	MDI_ExecuteBtn.dll
Macro trigger window	MDI_McrTrigger.dll
Message box display window	MDI_MsgBox.dll
Numerical value input window	MDI_NumBox.dll
Data settings button window	MDI_SetDataBtn.dll
Simple data grid window	MDI_SimpleDataGrid.dll

### 8-3-15 Data Grid Window (MDI\_DataGrid.dll)

Window part that is displayed on the main screen as a table using a macro, such as measurement results of a processing unit.

This function can not be used with the FHV series.

SimpleDataGrid	Camera 0	Camera 1	Camera 2	Camera 3	Camera 4	Camera 5
Value X						
Value Y						
Angle $\theta$						
Ave. X						
Ave. Y						
Ave. $\theta$						
std.						

This comprises the following elements.

- [Data grid]

Details that can be set are as follows.

**DataGrid\_setting**

**Macro Setting**  
Macro Type: Scene Macro

**Format Setting**  
Row Count: [ ]  
Col. Count: [ ]  
Col. Width: [ ]  
Row Height: [ ]

**Operation**  
Cell Select: [ ]  
Cell Edit: [ ]  
Selected Row: [ ]  
Selected Col.: [ ]

**Status**  
Front/Back: [ ]

**Cell Setting**  
Cell Data: [ ]  
Cell Color: [ ]  
Cell Align: [ ]  
Cell Edit Enable: [ ]  
Cell Judge Min: [ ]  
Cell Judge Max: [ ]

**Control**  
Control Command: 480(0x1E0)  
Control Param.  
Control ID+2000 Move to front  
Control ID+3000 Move to back  
Control ID+10000 Update all data  
Control ID+11000 Update single cell data  
Control ID+12000 Add new row  
Control ID: 0

**Font Setting**  
Size: 14 [ ] [ ] [ ] [ ] [ ] [ ] [ ] [ ] [ ] [ ]  
Style:  Bold  Italic  Underline  Strikeout  
Sample

OK Cancel

Setting item	Setting value [Factory default]	Description
Macro specification		Sets macro containing variables to display.
Macro Type	<ul style="list-style-type: none"> <li>• Macro Unit</li> <li>• [Scene Macro]</li> <li>• I/O Macro</li> </ul>	Sets which macro variables to display.
Unit Name	0 to 32 characters [0]	<p>Sets this when [Macro Unit] is selected in [Macro Type]. Specify the macro unit with a unit number or a unit label character string.</p> <p>Only single-byte alphanumeric characters as well as “_&amp;#x24;@” can be input.</p>
Format Setting		Sets table display related issues.
Row Count	[Blank] 1 to 128	<p>Specifies the variable name for the macro storing the table row count using up to 32 characters.</p> <p>However, only those integer type variables within the macro selected in [Macro Type] can be selected.</p> <p>If any of the following conditions are met, then regardless of the settings, the row count will be 1.</p> <ul style="list-style-type: none"> <li>• Variable is not specified.</li> <li>• Specified variable does not exist.</li> <li>• Value stored in the variable is other than numerical value.</li> </ul> <p>If any of the following conditions are met, then regardless of the settings, the row count will be 128.</p> <ul style="list-style-type: none"> <li>• Value stored in the variable is 129 or higher.</li> </ul>
Col. Count	[Blank]	<p>Specifies the variable name for the macro storing the table column count using up to 32 characters.</p> <p>However, only those integer type variables within the macro selected in [Macro Type] can be selected.</p> <p>The range of the column count for the table is from 1 to 32 columns.</p> <p>If any of the following conditions are met, then regardless of the settings, the column count will be 1.</p> <ul style="list-style-type: none"> <li>• Variable is not specified.</li> <li>• Specified variable does not exist.</li> <li>• Value stored in the variable is other than numerical value.</li> </ul> <p>If any of the following conditions are met, then regardless of the settings, the column count will be 32.</p> <ul style="list-style-type: none"> <li>• Value stored in the variable is 33 or higher.</li> </ul>

Setting item	Setting value [Factory default]	Description
Col. Width	[Blank]	<p>Specifies the variable name for the macro storing the table column width using up to 32 characters.</p> <p>However, only those integer type single dimensional array variables in the macro selected in [Macro Type] can be selected. It is necessary to specify individual column width by array and that the array element count be the [Col. Count] or higher.</p> <p>The range of the column width for the table is from 2 to 65536 columns.</p> <p>If any of the following conditions are met, then regardless of the settings, the total column width will be 100.</p> <ul style="list-style-type: none"> <li>• Variable is not specified.</li> <li>• Specified variable does not exist.</li> </ul> <p>If any of the following conditions are met, then regardless of the settings, the total column width will be 100.</p> <ul style="list-style-type: none"> <li>• Columns that the array element is lower than the [Col. Count] and the [Col. Width] is not defined.</li> </ul>
Row Height	[Blank]	<p>Specifies the variable name for the macro with the table row height using up to 32 characters.</p> <p>However, only those integer type single dimensional array variables in the macro selected in [Macro Type] can be selected. It is necessary to specify individual row width by array and that the array element count be the [Row Count] or higher.</p> <p>The range of the row height for the table is from 3 to 65536 rows.</p> <p>If any of the following conditions are met, then regardless of the settings, the total row width will be 24.</p> <ul style="list-style-type: none"> <li>• Variable is not specified.</li> <li>• Specified variable does not exist.</li> </ul> <p>If any of the following conditions are met, then regardless of the settings, the row height will be 24.</p> <ul style="list-style-type: none"> <li>• Rows that the array element is lower than the [Row Count] and the [Row Height] is not defined.</li> </ul>
Operation		Set during screen operation when calling a macro subroutine.
Cell Select	[Blank]	Specifies the name of the subroutine (including *) to execute at cell selection using up to 32 characters.
Cell Edit	[Blank]	Specifies the name of the subroutine (including *) to execute after cell data update using up to 32 characters.
Selected Row	[Blank]	<p>Specifies the macro variable to store the cell row numbers for the selected cells or cells having data updated using up to 32 characters.</p> <p>However, only integer type variables exist in the macro selected in [Macro Type].</p>
Selected Col.	[Blank]	<p>Specifies the macro variable to store the cell column numbers for the selected cells or cells having data updated using up to 32 characters</p> <p>However, only integer type variables exist in the macro selected in [Macro Type].</p>
Cell Setting		Sets the cell to display.

Setting item	Setting value [Factory default]	Description
Cell Data	[Blank]	<p>Specifies the variable name for the character string array that stores the cell data using up to 32 characters.</p> <p>However, only variables in single dimensional array of character string types that exist in the macro selected in [Macro Type] can be specified. The number of array elements must be the [Row Count] or higher.</p> <p>A separator character “;” needs to be added between cell data in the same row.</p> <p>Up to 31 characters can be displayed in a single cell.</p> <p>If any of the following conditions are met, regardless of the settings, all cells will be blank.</p> <ul style="list-style-type: none"> <li>• Variable is not specified.</li> <li>• Specified variable does not exist.</li> </ul> <p>Cells that meet any of the following conditions, regardless of the settings, will be blank.</p> <ul style="list-style-type: none"> <li>• Data is not specified.</li> </ul>
Cell Color	[Blank]	<p>Specifies the variable name for the character string array that stores the background color per cell using up to 32 characters.</p> <p>However, only variables in single dimensional array of character string types that exist in the macro selected in [Macro Type] can be specified. The number of array elements must be the [Row Count] or higher.</p> <p>A separator character “;” needs to be added between cell data in the same row.</p> <p>The background color is specified by using RGB brightness and a numerical value calculated with <math>R \times 65536 + G \times 256 + B</math>.</p> <p>If any of the following conditions are met, regardless of the settings, color for all cells will be white.</p> <ul style="list-style-type: none"> <li>• Variable is not specified.</li> <li>• Specified variable does not exist.</li> </ul> <p>If any of the following conditions are met, regardless of the settings, color for all cells will be white.</p> <ul style="list-style-type: none"> <li>• Value is not specified.</li> <li>• Specified value is other than a numerical value.</li> </ul>

Setting item	Setting value [Factory default]	Description
Cell Align	[Blank]	<p>Specifies the variable name for character string array that store the character position per cell using up to 32 characters.</p> <p>However, only variables in single dimensional array of character string types that exist in the macro selected in [Macro Type] can be specified. The number of array elements must be the [Row Count] or higher. A separator character “;” needs to be added between cell data in the same row.</p> <p>A value stored in variables is below</p> <ul style="list-style-type: none"> <li>• 0: Left-aligned</li> <li>• 1: Center</li> <li>• 2: Right-aligned</li> </ul> <p>If any of the following conditions are met, regardless of the settings, all cells will be left-aligned.</p> <ul style="list-style-type: none"> <li>• Value is not specified.</li> <li>• Value does not exist.</li> </ul> <p>Cells that meet any of the following conditions, regardless of the settings, will be left-aligned.</p> <ul style="list-style-type: none"> <li>• Value is not specified.</li> <li>• Value is out of range.</li> <li>• Specified value is other than a numerical value.</li> </ul>
Cell Edit Enable	[Blank]	<p>Specifies the variable name for the character string array that stores editing enabled or disabled per cell using up to 32 characters.</p> <p>However, only variables in single dimensional array of character string types that exist in the macro selected in [Macro Type] can be specified. The number of array elements must be the [Row Count] or higher. A separator character “;” needs to be added between cell data in the same row.</p> <p>A value stored in variables is below.</p> <ul style="list-style-type: none"> <li>• 0: Editing enabled</li> <li>• Other than 0: Editing disabled</li> </ul> <p>If any of the following conditions are met, regardless of the settings, all cells will be editing disabled.</p> <ul style="list-style-type: none"> <li>• Variable is not specified.</li> <li>• Specified variable does not exist.</li> </ul> <p>Cells that meet any of the following conditions, regardless of the settings, will be editing disabled.</p> <ul style="list-style-type: none"> <li>• Value is not specified.</li> <li>• Value is out of range.</li> <li>• Specified value is other than a numerical value.</li> </ul>

Setting item	Setting value [Factory default]	Description
Cell Judge Min Cell Judge Max	[Blank]	<p>Specifies the variable name for the character string array that stores maximum and minimum values using up to 32 characters.</p> <p>However, only variables in single dimensional array of character string types that exist in the macro selected in [Macro Type] can be specified. The number of array elements must be the [Row Count] or higher. A separator character “;” needs to be added between cell data in the same row.</p> <p>If a value in the cell selected with [Cell Data] is a numerical value, judge it with the specified maximum and minimum values and then display it in red if it is out of the range (NG). However, if neither the [Cell Judge Min] nor the [Cell Judge Max] is specified, it is not compared.</p> <p>If any of the following conditions are met, regardless of the settings, the maximum (or minimum) value for all cells will be 0.</p> <ul style="list-style-type: none"> <li>• Variable is not specified.</li> <li>• Specified variable does not exist.</li> </ul> <p>The maximum (or minimum) value of cells that meet any of the following conditions, regardless of the settings, will be 0.</p> <ul style="list-style-type: none"> <li>• Value is not specified.</li> <li>• Value is out of range.</li> <li>• Specified value is not numeric.</li> </ul>
Control		Sets when changing the status of data grid using a macro.
Control ID	0 to 999	The ID used to identify the operation target if using the macro RaiseOptionEvent relationship to carry out operations.
Status		Set the status of Window Part.
Front/Back	[Blank]	<p>Specifies the variable that stores the status of the display screen for the data grid window from the variable assignment window.</p> <p>However, only the Scene variable or the System variable can be specified.</p> <p>Refer to “<i>Assigning variables</i> on page 5-61”.</p> <p>When the variable value is:</p> <p>Positive: Move the window to the front.  Negative: Move the window to the back.  0: Do not move the window.</p>
Font Setting		Sets display font and display the set contents to the right of the font setting area.
Size	1 to 100 [14]	Sets the font size.
Style	<ul style="list-style-type: none"> <li>• Bold</li> <li>• Italic</li> <li>• Underline</li> <li>• Strikeout</li> </ul>	Sets the font style.



### Important

- Settings values in [Format Setting] specify variable names. You can not directly input numerical values.
- Set subroutine name to specify in [Operation] in accordance with the following rules.  
\*+[Single-byte alphabetical character]+[Single-byte alphanumeric character and \_ (underscore)]  
Example: \*MEASUREDISP



- For [Cell Setting], refer to the following.

Example: 3×3 table. The character string type 1 dimensional array has the cell values separated with a ";" (semicolon).

1	2	3
4	5	6
7	8	9

```
Dim Data$(2)
Data$(0)="1;2;3"
Data$(1)="4;5;6"
Data$(2)="7;8;9"
```

- In [Control], if using a macro RaiseOptionEvent to operate, then specify the control command in the event number, and the control parameters in the parameter.
- The data grid window is updated in the event of the following.  
Measurement results display event  
Cell data update event because of a RaiseOptionEvent

### 8-3-16 Login Account Display Window (MDI\_DisplLoginUser.dll)

Window part to display the login account.

You can display the Logout status window and Login status window.

Logout status window

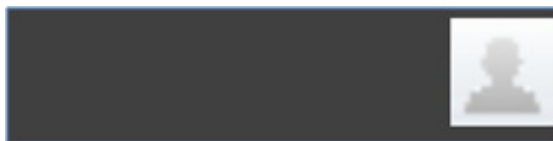

Login status window

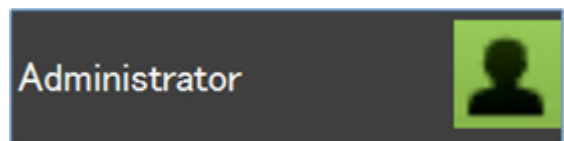

This comprises the following elements.

- [User name display label]: Displays a user account logged in.
- [Login icon]: Allows log-in/log-out operation by click.

Details that can be set are as follows.

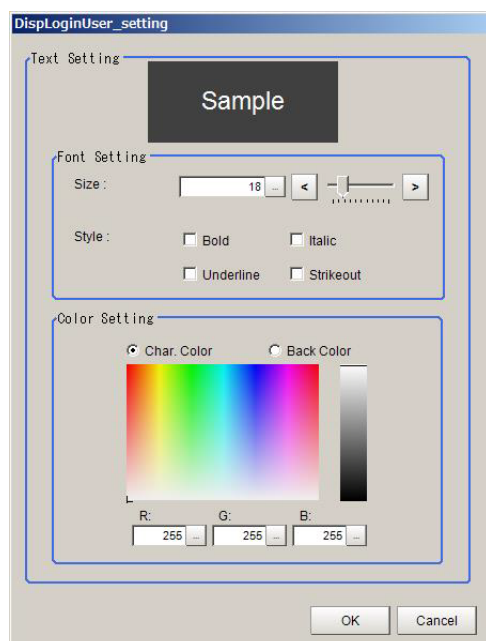

Setting item	Setting value [Factory default]	Description
Text Setting		Sets character data to display. The set contents for [Font Setting] and [Color Setting] are displayed in the [Text Setting] area.
Font Setting		Sets the font to display.
Size	1 to 100 [18]	Sets the font size.
Style	<ul style="list-style-type: none"> <li>• Bold</li> <li>• Italic</li> <li>• Underscore</li> <li>• Strikeout</li> </ul>	Sets the font style. Check the box of your desired style.
Color Setting	<ul style="list-style-type: none"> <li>• [Char. Color]</li> <li>• Back Color</li> </ul>	Sets the character and background colors. Char. Color: Sets the character color. Back color: Sets the background color.
	R: 0 to 255 [255] G: 0 to 255 [255] B: 0 to 255 [255]	

### 8-3-17 Setting Dialog Box Display Button Window (MDI\_DispSetupBtn.dll)

Settings dialog box display button window (MDI\_DispSetupBtn.dll)

Window part to start the processing item settings dialog box and external tools through use of buttons.

This comprises the following elements.

- [Display button]

Details that can be set are as follows.

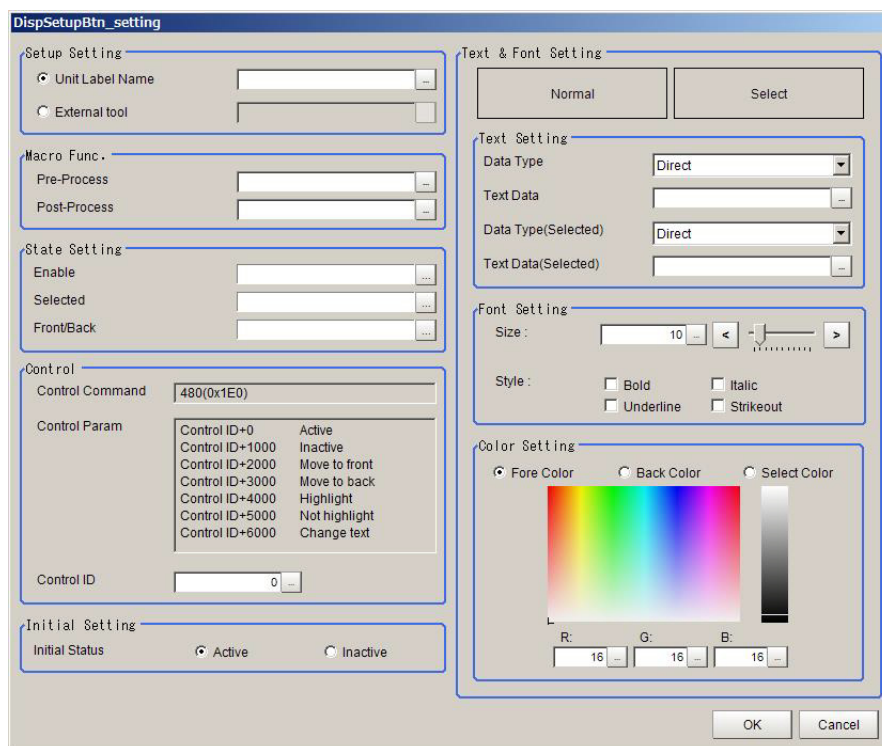

Setting item	Setting value [Factory default]	Description
Setup Setting		Sets the Setup window.
Unit Label Name	[Blank]	Specifies the processing unit to start the Setup window using either a unit number or unit label character string using up to 32 characters.  Only single-byte alphanumeric characters and “_&#x24;” can be input.
External tool	[Blank]	Specifies an external tool to start using a character string.* <sup>1</sup>
Macro Func.		Sets this before and after starting the Setup window when calling a macro subroutine.
Pre-Process	[Blank]	Specifies the subroutine name (including *) to execute before displaying the Setup window using up to 32 characters.
Post-Process	[Blank]	Specifies the subroutine name (including *) to execute after closing the Setup window using up to 32 characters.
Control		Set this when changing the status of the processing item setting display button window by using a macro.
Control ID	0 to 999 [0]	Identifies the operation objects when operating by using a macro of RaiseOptionEvent function.
Initial Setting		Set the startup default conditions.
Initial Status	<ul style="list-style-type: none"> <li>• [Active]</li> <li>• Inactive</li> </ul>	Sets the button operation enabled or disabled when starting up the sensor controller.
Text & Font Setting		Display the setting contents for [Text Setting], [Font Setting], and [Color Setting].
Text Setting		Sets character data to display.
Data Type	<ul style="list-style-type: none"> <li>• [Direct]</li> <li>• Variable</li> </ul>	Sets text data to display on the button.  Direct: Directly input to the [Text Data].  Variable: Specify a system variable or a scene variable of character string type that defines a character string to display.
Text Data	0 to 128 Characters [Blank]	Specifies text data to display on the button.
Data Type (Selected)	<ul style="list-style-type: none"> <li>• [Direct]</li> <li>• Variable</li> </ul>	Sets text data to display at the button selection.  Direct: Directly input to the [Text Data].  Variable: Specify a system variable or a scene variable of character string type that defines a character string to display.
Text Data (Selected)	0 to 128 Characters [Blank]	Specifies text data to display at the button selection.
Font Setting		Set the font setting to display.
Size	1 to 100 [10]	Sets the font size.
Style	<ul style="list-style-type: none"> <li>• Bold</li> <li>• Italic</li> <li>• Underline</li> <li>• Strikeout</li> </ul>	Sets the font style.  Check the box to set the desired style.
Color Setting	<ul style="list-style-type: none"> <li>• [Fore Color]</li> <li>• Back Color</li> <li>• Select Color</li> </ul>	Sets the font color, background color, and the background color at selection.  Fore Color: Set the character color.
	R: 0 to 255 [16] G: 0 to 255[16] B: 0 to 255[16]	Back Color: Set the button color in normal state. Select Color: Set the button color in selection state.

\*1. Character strings for external tool startup setting



### Important

---

- Set a subroutine name to specify in [Macro Func.] in accordance with the following rules.  
\*?[Single-byte alphabetical character]?[Single-byte alphanumeric character and \_ (underscore)]  
Example: \*MEASUREDISP
  - In [Control], if using a macro RaiseOptionEvent to operate, then specify the control command in the event number, and the control parameters in the parameter.
-

### 8-3-18 Text Display Window (MDI\_DispText.dll)

Window part to display character strings.

This comprises the following elements.

- [Text label]

Details that can be set are as follows.

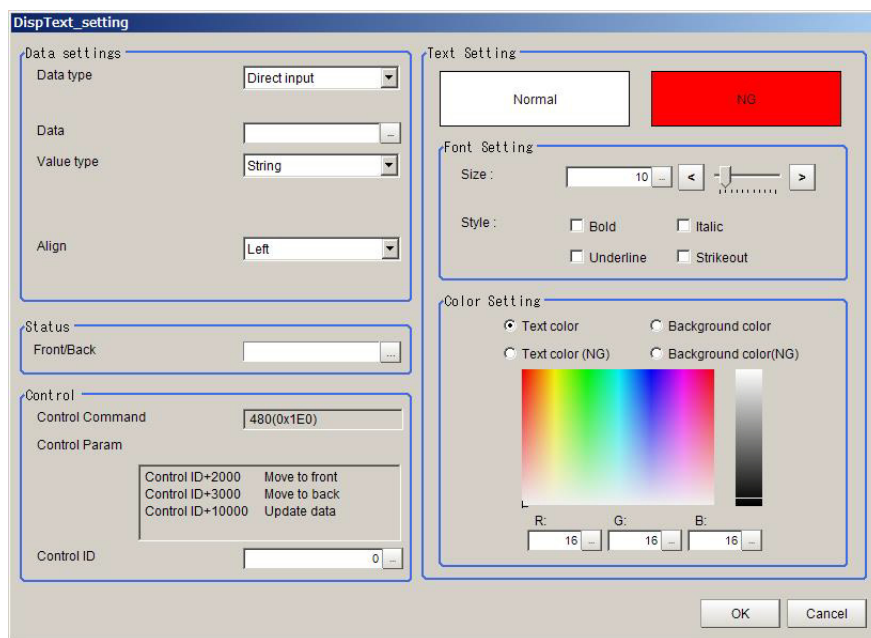

Setting item	Setting value [Factory default]	Description
Data settings		Sets data to display.
Data type	<ul style="list-style-type: none"> <li>• [Direct input]</li> <li>• Unit data</li> <li>• Scene variable</li> <li>• Global data</li> <li>• System data</li> <li>• System variable</li> </ul>	Selects the data type for display object.
Unit	[Blank]	<p>This item is available when [Unit data] is selected in [Data type].</p> <p>Specifies the unit to set data with a unit number or unit label character string using up to 32 characters.</p> <p>Only single-byte alphanumeric characters as well as "_&amp;#@\$@" can be input.</p>
Data identifier 0	<ul style="list-style-type: none"> <li>• [PandDA]</li> <li>• Macro_IO</li> </ul>	<p>This item is available when [System data] is selected in [Data type].</p> <p>Selects the system data identifier name 0 from the combo box.</p>
Data	[Blank]	<p>This item is available when [Direct input] is selected in [Data type].</p> <p>Sets the character string to display using up to 128 characters. Multi-language input is possible.</p>

Setting item	Setting value [Factory default]	Description
Data identifier/ number/variable	[Blank]	This item is available when other than [Direct input] is selected in [Data type]. Setting contents vary depending on the [Data type]. Up to 32 characters can be input. 1. Unit data: External reference number or identifier name 2. Scene variable/System variable: Variable name 3. System data/Global data: Identifier name
Value type	<ul style="list-style-type: none"> <li>• [String]</li> <li>• Number</li> </ul>	Specifies the data type.
Align	<ul style="list-style-type: none"> <li>• [Left]</li> <li>• Center</li> <li>• Right</li> </ul>	Sets the character display position.
Status		Sets the window part status.
Front/Back	[Blank]	Specifies the variable to store the text display window status from the variable assignment window. However, only the scene variable or system variable can be specified. When the variable value is: Positive: Move window to the front. Negative: Move window to the back. 0: Do not move the window.
Control		Sets when changing the status for the processing item setting window display button using a macro.
Command ID	0 to 999 [0]	The ID used to identify the operation target when using the macro RaiseOptionEvent relationship to carry out operations.
Text Setting		The set contents of [Font Setting] and [Color Setting] are displayed in the display setting area.
Font Setting		Sets the display font.
Size	1 to 100 [10]	Sets the font size.
Style	<ul style="list-style-type: none"> <li>• Bold</li> <li>• Italic</li> <li>• Underline</li> <li>• Strikeout</li> </ul>	Sets the font style. Check the box to set desired style.
Color Setting	<ul style="list-style-type: none"> <li>• [Text color]</li> <li>• Background color</li> <li>• Text color (NG)</li> <li>• Background color (NG)</li> </ul>	Sets the background color when it is selected, font color, and background color. Text color: Set the character color in OK state. Background color: Set the character background color in OK state. Text color (NG): Set the character color in NG state. Background color (NG): Set the character background color in NG state.
	R: 0 to 255 [16] G: 0 to 255 [16] B: 0 to 255 [16]	



### Important

- In [Control], if using a macro RaiseOptionEvent to operate, then specify the control command in the event number, and the control parameters in the parameter.
- The text display window is updated in the event of the following.  
Cell data update event because of a RaiseOptionEvent

### 8-3-19 Custom Dialog Display Button Window (MDI\_ExecuteBtn.dll)

Custom dialog display button window (MDI\_ExecuteBtn.dll)

Window part to start the Custom dialog at button click.

This comprises the following elements.

- [Display button]

Details that can be set are as follows.

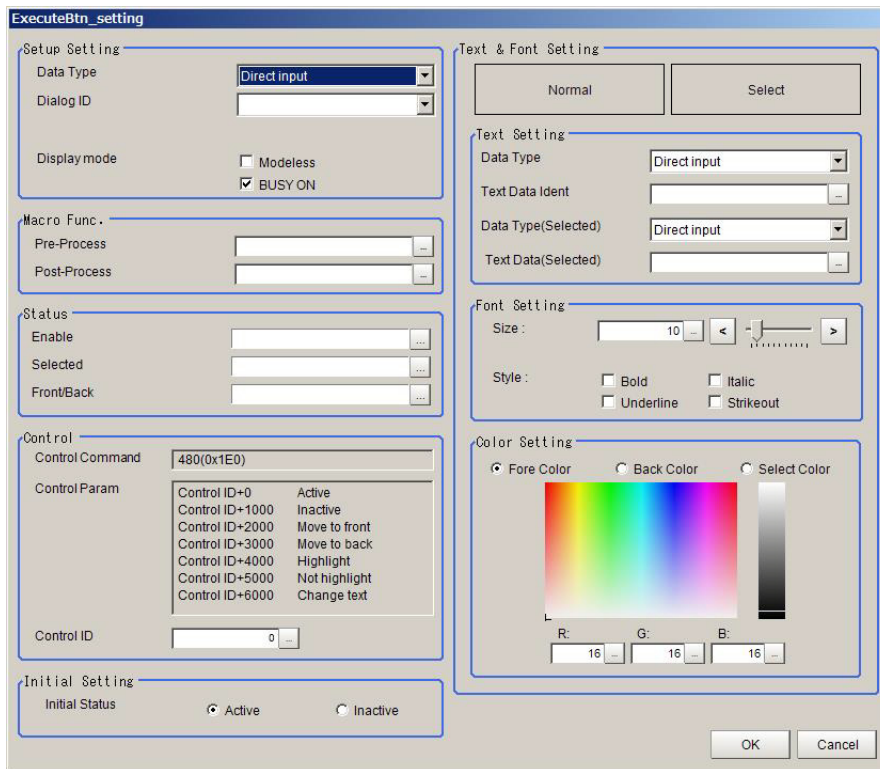

Setting item	Setting value [Factory default]	Description
Setup Setting		Sets the custom dialog to display.
Data Type	<ul style="list-style-type: none"> <li>• [Direct input]</li> <li>• Scene variable</li> <li>• System variable</li> </ul>	Sets the method to specify the Custom dialog's dialog ID.
Dialog ID	[Blank]	<p>This item is available when [Directly specify] is selected in [Data type].</p> <p>Sets the method to specify the Custom dialog's dialog ID to start. Select defined dialog IDs displayed as a candidate in the combo box.</p> <p>When the specified dialog has been deleted in the Custom dialog tool, then this will be displayed as empty the next time the Settings dialog box is opened.</p>
Variable	[Blank]	<p>This item is available when other than [Direct input] is selected in [Data type].</p> <p>Sets the variable that stores the dialog ID character string.</p>

Setting item	Setting value [Factory default]	Description
Display mode	<ul style="list-style-type: none"> <li>• Modeless</li> <li>• [BUSY ON]</li> </ul>	<p>Sets the display mode.</p> <p>Modeless: Select this when using a display in which other operations can be executed or other window parts can be started (modeless display) while a specified Custom dialog is started.</p> <p>BUSY ON: Select this when setting BUSY to ON while a specified Custom dialog is started.</p>
Macro Func.		Sets this before and after starting the Setup window when calling a macro subroutine.
Pre-Process	[Blank]	Specifies the subroutine name (including *) to execute before displaying the Setup window using up to 32 characters.
Post-Process	[Blank]	Specifies the subroutine name (including *) to execute after closing the Setup window using up to 32 characters.
Status		Sets the status for the window part.
Enable	[Blank]	<p>Specifies the variable to store the text display window status from the variable assignment window.</p> <p>However, only the scene variable or system variable can be specified.</p> <p>Refer to <i>Assigning variables</i> on page 5-61.</p> <p>The variable value is:</p> <p>0: Set the Custom dialog to disabled state.</p> <p>Other than 0: Set the Custom dialog to enabled state.</p>
Selected	[Blank]	<p>Specifies the variable to store the text display window status from the variable assignment window.</p> <p>However, only the scene variable or system variable can be specified.</p> <p>Refer to <i>Assigning variables</i> on page 5-61.</p> <p>The variable value is:</p> <p>0: Set the Custom dialog to normal state.</p> <p>Other than 0: Set the Custom dialog to selection state.</p>
Front/Back	[Blank]	<p>Specifies the variable to store the text display window status from the variable assignment window.</p> <p>However, only the scene variable or system variable can be specified.</p> <p>Refer to <i>Assigning variables</i> on page 5-61.</p> <p>When the variable value is:</p> <p>Positive: Move window to the front.</p> <p>Negative: Move window to the back.</p> <p>0: Do not move the window.</p>
Control		Sets when changing the status for the processing item setting window display button using a macro.
Control ID	0 to 999 [0]	The ID used to identify the operation target when using the macro RaiseOptionEvent relationship to carry out operations.



Setting item	Setting value [Factory default]	Description
Text & Font Setting		Displays the setting contents for [Text Setting], [Font Setting], and [Color Setting].
Text Setting		Sets character data to display.
Data Type	<ul style="list-style-type: none"> <li>• [Direct input]</li> <li>• Variable</li> </ul>	Sets text data to display on the button. Direct input: Directly input to the [Text Data]. Variable: Specify a system variable or a scene variable of character string type that defines a character string to display.
Text Data Ident	[Blank]	Specifies text data to display on the button using up to 128 characters.
Data Type (Selected)	<ul style="list-style-type: none"> <li>• [Direct input]</li> <li>• Variable</li> </ul>	Sets text data to display at the button selection. Direct input: Directly input to the [Text Data]. Variable: Specify a system variable or a scene variable of character string type that defines a character string to display.
Text Data (Selected)	0 to 128 characters	Specifies text data to display at the button selection using up to 128 characters.
Font Setting		Sets the display font.
Size	[Blank]	Sets the font size.
Style	<ul style="list-style-type: none"> <li>• Bold</li> <li>• Italic</li> <li>• Underline</li> <li>• Strikeout</li> </ul>	Sets the font style. Check the box to set desired style.
Color Setting	<ul style="list-style-type: none"> <li>• [Fore Color]</li> <li>• Back Color</li> <li>• Select Color</li> </ul>	Sets the font color, background color, and the background color at selection.
	R: 0 to 255 [16]	Back Color: Set the button color in normal state.
	G: 0 to 255 [16]	Select Color: Set the button color in selection state.
	B: 0 to 255 [16]	
Initial Setting		Sets the startup default conditions for the custom dialog display buttons.
Initial Status	[Active] Inactive	Sets the button operation enabled or disabled when starting up the sensor controller.



### Important

- In [Display mode], there are the following restrictions when [Modeless] is selected.  
In dialog scene settings, you can not switch between scenes.  
If a custom dialog is started up while displaying another dialog, performing measurement, or performing communication commands, an error dialog will be displayed and cancel the current processing.
- Set subroutine name to specify in [Macro processing (scene macro)] in accordance with the following rules.  
\*+[Single-byte alphabetical character]+[Single-byte alphanumeric character and \_ (underscore)]  
Example: \*MEASUREDISP
- In [Control], if using a macro RaiseOptionEvent to operate, then specify the control command in the event number, and the control parameters in the parameter.

### 8-3-20 Macro Trigger Window (MDI\_McrTrigger.dll)

Part to call a macro subroutine at a specific timing.

This window part does not have display elements for the main screen.

This function can not be used with the FHV series.

Details that can be set are as follows.

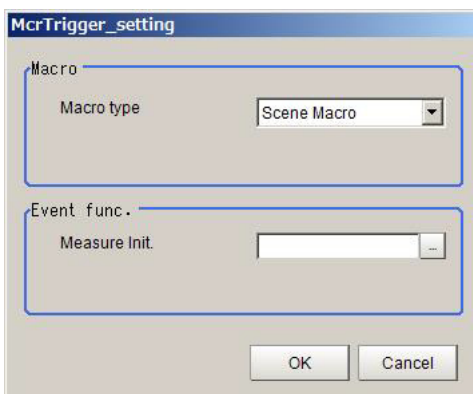

Setting item	Setting value [Factory default]	Description
Macro		Sets macro to call.
Macro type	<ul style="list-style-type: none"> <li>• [Scene Macro]</li> <li>• IO Macro</li> </ul>	Sets the macro type to execute.
Event func.		Sets the timing.
Measure init.	[Blank]	Specifies the macro subroutine (including *) to execute when the measurement initialization was executed.
Scene switching	[Blank]	This item is available when [IO Macro] is selected in [Macro type]. Specifies the macro subroutine (including *) when the scene switching was performed.



#### Important

- Set subroutine name to specify in [Event Func.] in accordance with the following rules.  
\*+[Single-byte alphabetical character]+[Single-byte alphanumeric character and \_ (underscore)]

Example: \*MEASUREDISP

### 8-3-21 Message Box Display Window (MDI\_MsgBox. dll)

Window part to display a message box from macro processing.

This function can not be used with the FHV series.

You can display two types - a 1 button message box and a 2 button message box.



This window part does not have display elements for the main screen.

There is no UI for setting. Specify by setting a value in global data.

Identifier name	Description [Factory default]
MsgBoxCaptionText	Set the window title character string.
MsgBoxMessageText	Set the message character string. If the message will be displayed over multiple lines, then insert LF (Chr\$(10)) at the line break.
MsgBoxButtons	Sets the character string to display on the button. Up to a maximum of two buttons can be set by separating with a semicolon (;). Example: 1 button: "OK" 2 buttons: "OK;Cancel"
MsgBoxResult	Stores the number of the button pressed in the message box. Example: 1st button pressed: 0 stored 2nd button pressed: 1 stored

The usage method is to specify an event number of 480 for the RaiseOptionEvent relationship, and 20000 for the parameter to display the message box.

Example)

```
SetGlobalData "MsgBoxCaptionText", "Title character string"
```

```
SetGlobalData "MsgBoxMessageText", "Message character string"
```

```
SetGlobalData "MsgBoxButtons", "OK"
```

```
RaiseOptionEvent 480,20000
```

### 8-3-22 Value Input Window (MDI\_NumBox.dll)

Window part to processing item parameters and macro variable numerical values.

This comprises the following elements.

- [Numerical value input box]  
Details that can be set are as follows.

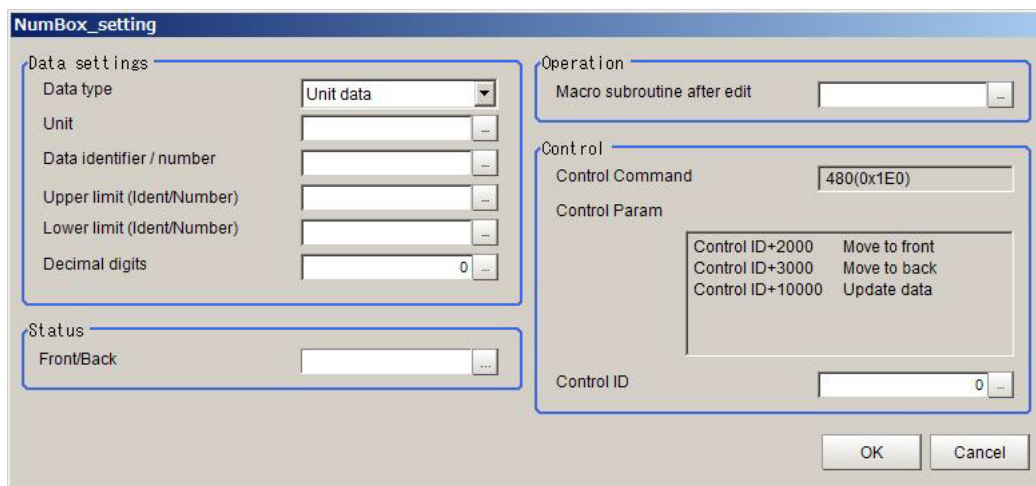

Setting item	Setting value [Factory default]	Description
Data settings		Configure settings for numerical input data.
Data type	<ul style="list-style-type: none"> <li>• [Unit data]</li> <li>• Scene variable</li> <li>• Global data</li> <li>• System data</li> <li>• System variable</li> </ul>	Selects the data type to input numerical value.
Unit	[Blank]	This item is available when [Unit data] is selected in [Data type]. Sets the unit to set the numerical value input data using a unit number or unit label character string using up to 32 characters. Only single-byte alphanumeric characters as well as "_&#@\$" can be input.
Data identifier 0	<ul style="list-style-type: none"> <li>• PandDA</li> <li>• Macro IO</li> </ul>	This item is available when [System data] is selected in [Data type]. Selects the identifier name 0 of the system data from the combo box.
Data identifier/number/variable	[Blank]	Sets the identifier name of data to input numerical value using up to 32 characters. The setting contents vary depending on [Data type]. Unit data: External reference data number or identifier name Scene variable or System variable: Variable name System data or Global data: Identifier name

Setting item	Setting value [Factory default]	Description
Upper limit (Ident/Number) Lower limit (Ident/Number)	[Blank]	Sets the upper limit/lower limit numerical values that can be input using up to 32 characters. The setting contents vary depending on [Data type]. Unit data: External reference data number or identifier name Scene variable or System variable: Variable name System data or Global data: Identifier name
Decimal digits	0 to 10 [0]	Sets the number of digits after the decimal point for the data to input numerical value.
Status		Sets the window part status.
Front/Back	[Blank]	Specifies the variable to store the status of the numerical value input window from the variable allocation window. However, only scene variables and system variables can be specified. Refer to <i>Assigning variables</i> on page 5-61. When the variable value is: Positive: Move the window to the front. Negative: Move the window to the back. 0: Do not move the window.
Operation		Sets this when calling a macro subroutine after inputting numerical values and updating data.
Macro subroutine after edit	[Blank]	This is effective only when [Unit data] is selected in [Data type] and a macro is specified in [Unit].
Control		Sets this when changing the status of the numerical value input window using a macro.
Control ID	0 to 999 [0]	The ID used to identify the operation object if using the macro RaiseOptionEvent relationship to carry out operations.



### Important

- Set subroutine name to specify in [Operation] in accordance with the following rules.  
\*+[Single-byte alphabetical character]+[Single-byte alphanumeric character and \_ (underscore)]  
Example: \*MEASUREDISP
- In [Control], if using a macro RaiseOptionEvent to operate, then specify the control command in the event number, and the control parameters in the parameter.

### 8-3-23 Data Settings Button Window (MDI\_SetDataBtn.dll)

Window part that displays on the main screen as a button to set parameters such as processing unit. This comprises the following elements.

- [Settings button]  
Details that can be set are as follows.

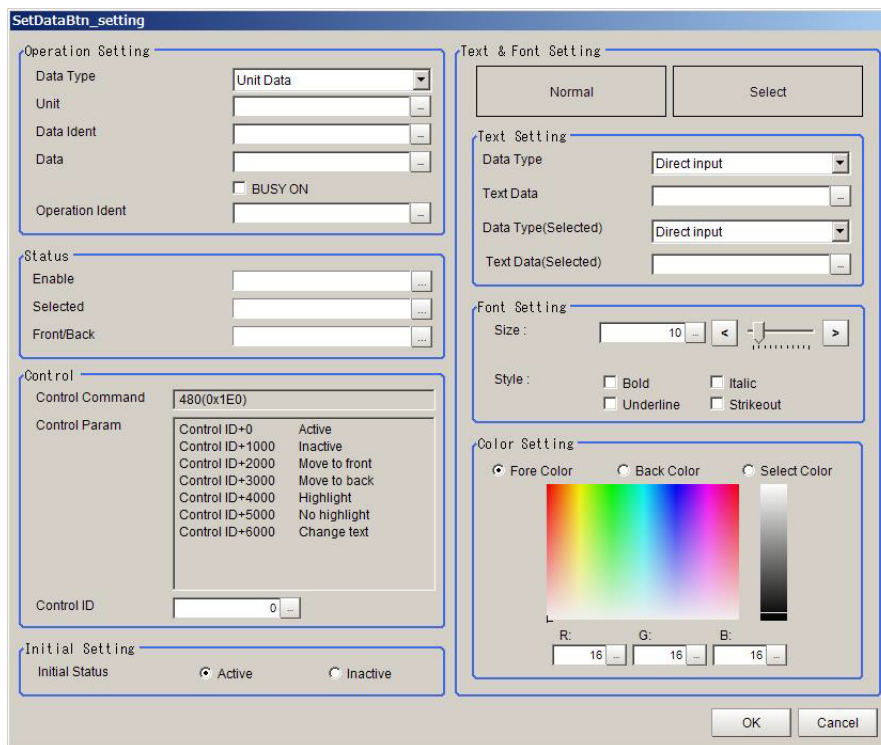

Setting item	Setting value [Factory default]	Description
Operation Setting		Configures the settings related to data for the data setting objects.
Data Type	<ul style="list-style-type: none"> <li>• [Unit data]</li> <li>• Scene variable</li> <li>• Global Data</li> <li>• System Data</li> <li>• System variable</li> </ul>	Selects the data type for the data setting object.
Unit	[Blank]	<p>This item is available when [Unit Data] is selected in [Data Type].</p> <p>Sets the unit to set data using a unit number or unit label character string using up to 32 characters.</p> <p>Only single-byte alphanumeric characters as well as “_&amp;#x26;\$@” can be input.</p>
Data ident 0	<ul style="list-style-type: none"> <li>• [PanDA]</li> </ul>	<p>This item is available when [System Data] is selected in [Data Type].</p> <p>Selects the identifier 0 for the system data.</p>

Setting item	Setting value [Factory default]	Description
Data ident/Variable	[Blank]	Sets the identifier name for the data to set using up to 32 characters. The setting contents vary depending on [Data Type]. 1. Unit data: External reference number or identifier name 2. Scene variable/System variable: Variable name 3. System data/Global data: Identifier name Specify "gosub" when calling a macro subroutine and specify "direct" for direct execution.
Data	[Blank]	Specifies the numerical value data or character string to set. Specify using up to 32 characters the name of the subroutine (including*) if executing a macro subroutine. For direct execution, specify the macro program.
BUSY ON	• [Unchecked] • Checked	Check the box to turn on BUSY during data setting.
Operation ident		Sets when controlling the button operation with security. Set the identifier name to write to Message\FZ-SecuritySetting_XXX.msg.
Status		Sets the status for the data setting button.
Enable	[Blank]	Specifies the variable to store the data setting button status from the variable assignment window. However, only the scene variable or system variable can be specified. Refer to <i>Assigning variables</i> on page 5-61. The variable value is: 0: Set the data setting button to disabled state. Other than 0: Set the data setting button to enabled state.
Selected	[Blank]	Specifies the variable to store the data setting button status from the variable assignment window. However, only the scene variable or system variable can be specified. Refer to <i>Assigning variables</i> on page 5-61. The variable value is: 0: Set the data setting button to normal state. Other than 0: Set the data setting button to selection state.
Front/Back	[Blank]	Specifies the variable to store the data setting button status from the variable assignment window. However, only the scene variable or system variable can be specified. Refer to <i>Assigning variables</i> on page 5-61. The variable value is: Positive: Move window to the front. Negative: Move window to the back. 0: Do not move the window.
Control		Sets when changing the status for the numerical value input window using a macro.
Control ID	0 to 999 [0]	The ID used to identify the operation target when using the macro RaiseOptionEvent relationship to carry out operations.
Text & Font Setting		Displays the setting contents for [Text Setting], [Font Setting], and [Color Setting].
Text Setting		Sets character data to display.

Setting item	Setting value [Factory default]	Description
Data Type	<ul style="list-style-type: none"> <li>• [Direct Input]</li> <li>• Variable</li> </ul>	<p>Sets text data to display on the button.</p> <p>Direct input: Directly input to the [Text Data].</p> <p>Variable: Specify a system variable or a scene variable of character string type that defines a character string to display.</p>
Text Data	[Blank]	Specifies text data to display on the button using up to 128 characters.
Data Type (Selected)	<ul style="list-style-type: none"> <li>• [Direct Input]</li> <li>• Variable</li> </ul>	<p>Sets text data to display at the button selection.</p> <p>Direct input: Directly input to the [Text Data].</p> <p>Variable: Specify a system variable or a scene variable of character string type that defines a character string to display.</p>
Text Data (Selected)	[Blank]	Specifies text data to display at the button selection using up to 128 characters.
Font Setting		Sets the display font.
Size	1 to 100 [10]	Sets the font size.
Style	<ul style="list-style-type: none"> <li>• Bold</li> <li>• Italic</li> <li>• Underline</li> <li>• Strikeout</li> </ul>	Sets the font style. Check the box to set desired style.
Color Setting	<ul style="list-style-type: none"> <li>• [Fore Color]</li> <li>• Back Color</li> <li>• Select Color</li> </ul>	Sets the font color, background color, and the background color at selection.
	R: 0 to 255 [16] G: 0 to 255 [16] B: 0 to 255 [16]	<p>Fore Color: Set the character color.</p> <p>Back Color: Set the button color in normal state.</p> <p>Select Color: Set the button color in selection state.</p>
Initial Setting		Sets the startup default conditions for the custom dialog display buttons.
Initial Status	<ul style="list-style-type: none"> <li>• [Active]</li> <li>• Inactive</li> </ul>	Sets the button operation enabled or disabled when starting up the sensor controller.



### Important

- Set subroutine name to specify in [Set operation] in accordance with the following rules.  
\*+[Single-byte alphabetical character]+[Single-byte alphanumeric character and \_ (underscore)]  
Example: \*MEASUREDISP
- In [Control setting], if using a macro RaiseOptionEvent to operate, then specify the control command in the event number, and the control parameters in the parameter.



### 8-3-24 Simple Data Grid Window (MDI\_SimpleDataGrid.dll)

A window part for displaying on the main screen as a table.

A grid screen like below can be displayed.

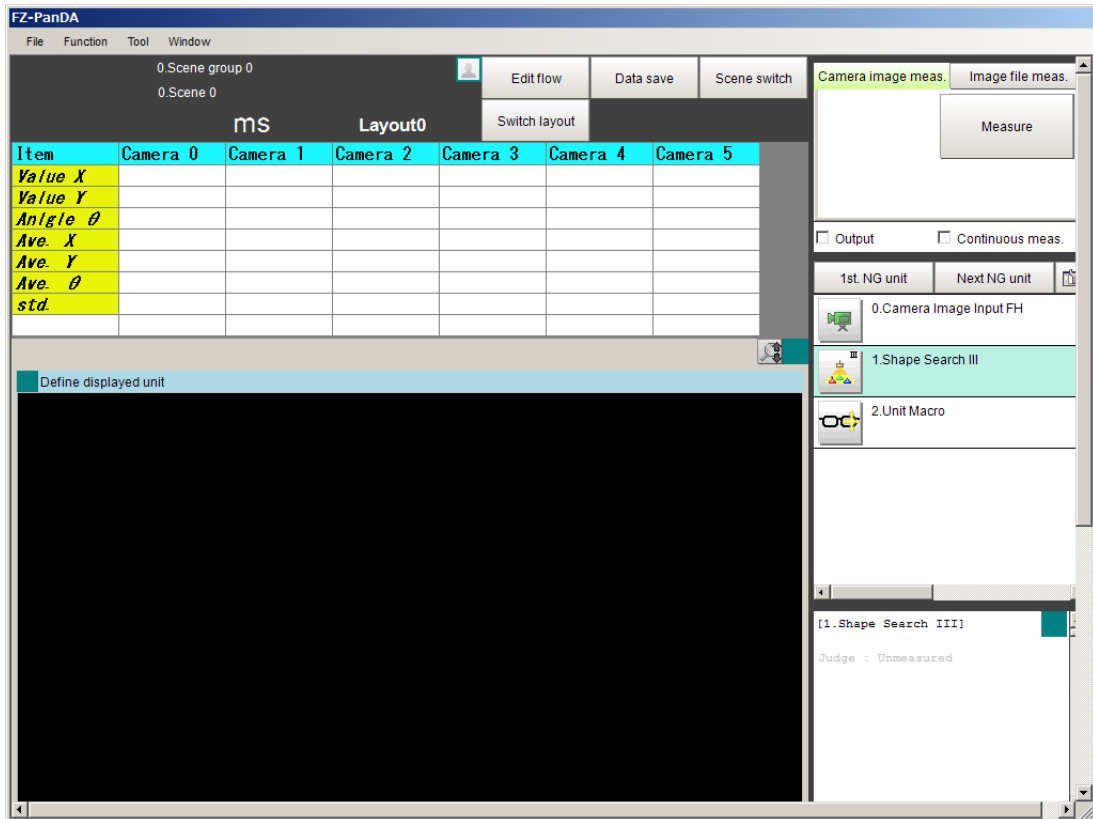

However, note that the following functions are disabled to make it easier to use than the “DataGrid” window.

- The function to dynamically change the number of rows and columns.
- The function to dynamically change the height of rows and width of columns.
- Direct editing of cell values
- The function to execute macro processing when a cell is selected.
- The function to control by using an option event from a macro

The following elements are displayed.

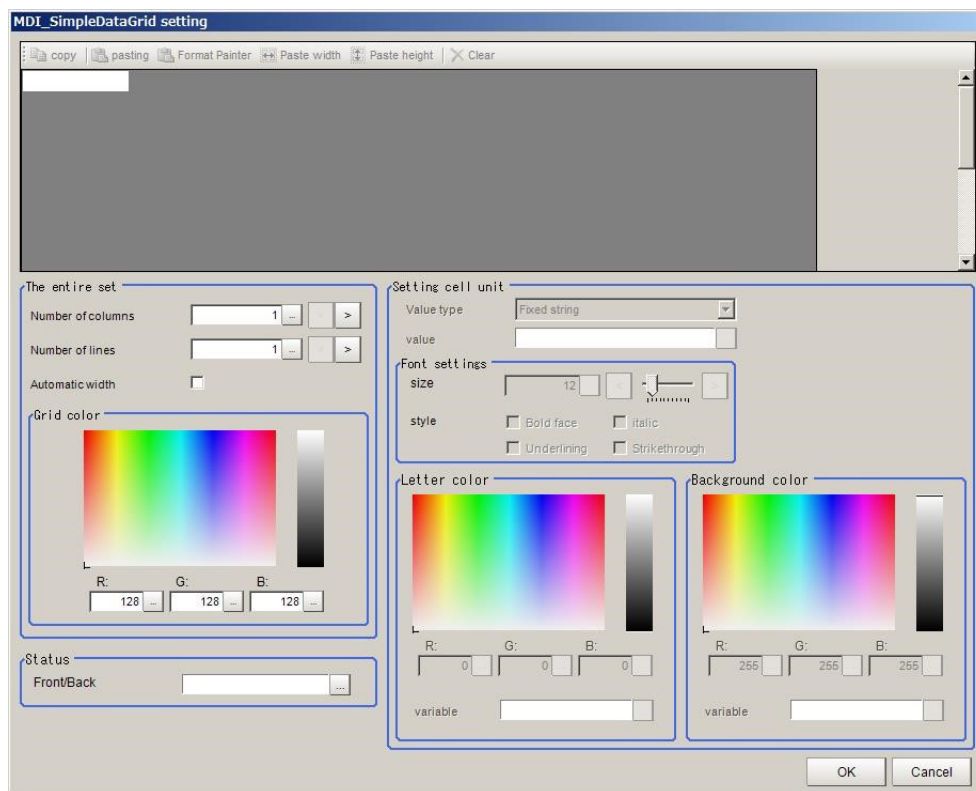

- Data Grid

The settings and their values are as follows.

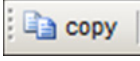
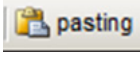
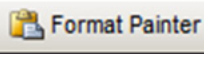

Setting item	Setting value [Factory default]	Description
The entire set		
Number of columns	1 to 32 [1]	Specifies the number of columns in the data grid.
Number of lines	1 to 128 [1]	Specifies the number of rows in the data grid.
Automatic width	<ul style="list-style-type: none"> <li>• [Unchecked]</li> <li>• Checked</li> </ul>	Enables or disables automatic width adjustment of columns. Checked: Enabled Unchecked: Disabled
Grid color	R: 0 to 255 [160] G: 0 to 255 [160] B: 0 to 255 [160]	Specifies the grid line color of the data grid.
Status		
Front/Back	[Blank]	On the “Variable assignment” screen that is displayed, specify the variables to be linked with Front/Back.
Cell Setting		
Value type	[Fixed string] Variable	Specifies the data type to display in the cell.
Value [Fixed string]	[Blank]	Specifies a fixed character string to display in the cell using up to 255 characters. The default characters displayed will be according to the selected display language (jpn\ あああ \eng\aaa·).
Value (Variable)	[Blank]	Specifies a variable for the data type to display in the cell. The default characters displayed for variables will be according to the selected display language (jpn\ あああ \eng\aaa·). What is displayed for a variable in the grid display area is the variable name, not the current value of the variable.

Setting item	Setting value [Factory default]	Description
Font Settings		
Size	1 to 100 [12]	Sets the font size of the cell.
Style	<ul style="list-style-type: none"> <li>• Bold</li> <li>• Italic</li> <li>• Underline</li> <li>• Strikethrough</li> </ul>	Sets the font style of the cell.
Text color		
	R: 0 to 255 [0] G: 0 to 255 [0] B: 0 to 255 [0]	Sets the text color of a cell.
Variable	[Blank]	<p>Selects this to make the text color of the cell specified by a variable.</p> <p>If variable is set here, the "Text color" setting is disabled.</p>
Background color		
	R: 0 to 255 [255] G: 0 to 255 [255] B: 0 to 255 [255]	Specifies the background color of a cell.
Variable	[Blank]	<p>Select this to make the background color of a cell specified by a variable.</p> <p>If variable is set here, the "Background color" setting is disabled.</p>

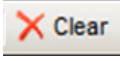
Icon	Description
	After selecting the cell, click this icon or right-click and click [Copy] from the displayed menu, or press [Ctrl+C] to copy the contents of the cell.
	After copying, select the cell you wish to paste to. Click this icon or right click and click [Paste] from the displayed menu, or [Ctrl+V] to make the "Value type", "Value", Font "Size", "Style", "Text color", "Text color variable", "Background color" and "Background color variable" to be the same as the copy source cell.
	After copying, select a cell, click this icon, or right click and click [Format Painter] from the displayed menu, or [Ctrl+F] to make the font "Size" and "Style", "Text color", "Text color variable", "Background color" and "Background color variable" to be the same as the copy source cell.
	After copying, select a cell, click this icon, or right click and click [Paste width] from the displayed menu, or [Ctrl+W] to make the column width to be the same as the copy source cell.
	After copying, select a cell, click this icon, or right click and click [Paste height] from the displayed menu, or [Ctrl+H] to make the height to be the same as the copy source cell.
	<p>After selecting the cell, click this icon or right-click and click [Clear] from the displayed menu, or press [Delete] to return the cell to its initial settings.</p> <p>However, note that the cell width and height cannot be returned to their initial settings.</p>



### Important

If the size of the data set exceeds 100000 characters, the message "Failed to save setting data. Setting data is too long." will be displayed.



### Additional Information

You can also adjust the cell height/width by dragging the grid lines.

## 8-3-25 Troubleshooting

Symptom	Setting	Correction
The RUN signal is not output.	Layout setup	Select [Layout setup] from the [Window] menu and select the [RUN signal output] check box for the layout to be used.
The layout of the Image container window cannot be changed.	---	Click the button in the upper right corner of the Image container window when the Layout modification Pane is not displayed in the Main Window.
Cannot create a backup of the layout settings.	---	The layout data is included in the system data and saved in the Sensor Controller when you click [Data save]. To save or load the settings to or from a file, click [Save to file] or [Load from file] to save or load the system data and scene group 0 data or the system settings data. After loading the system settings, change to a layout number different from the one being edited, then switch back to the layout number being edited. the updated contents will be displayed.
An image of a window part remains in the Main Window when modifying the layout.	Layout modification	When you finish modifying the layout, the display will be updated and window parts will be displayed correctly.
Unable to output the measurement result to an external device after Switch layout is executed.	Layout setup	If "Output" is set to OFF in the Layout setup of the layout to be used, the measurement result can not be externally output immediately after launching the system, or after Switch layout. Even if you check "Output" in the measurement window of the main screen, the setting selection for "Output" in the Layout setup menu will be used when switching layouts. Before executing measurement, set "Output" to ON in the Layout setup menu of the layout to be used.
Editing contents are not reflected when you confirm the Sensor Controller after edit a layout by remote control.	Layout modification	Change to a layout number different from the one was edited, then switch back to the edited layout number. The updated contents will be displayed.

## 8-4 Creating a Custom Dialog Box [Custom Dialog Functions]

You can create a customized settings dialog box on the Sensor Controller and display it instead of the normal settings dialog boxes for each processing item.

This allows you to hide parameter settings that must not be changed during normal operation, and show only the parameters that are necessary. You can also create a settings dialog box that allows the operator to change the settings for more than one processing unit.

### 8-4-1 Flow of Use

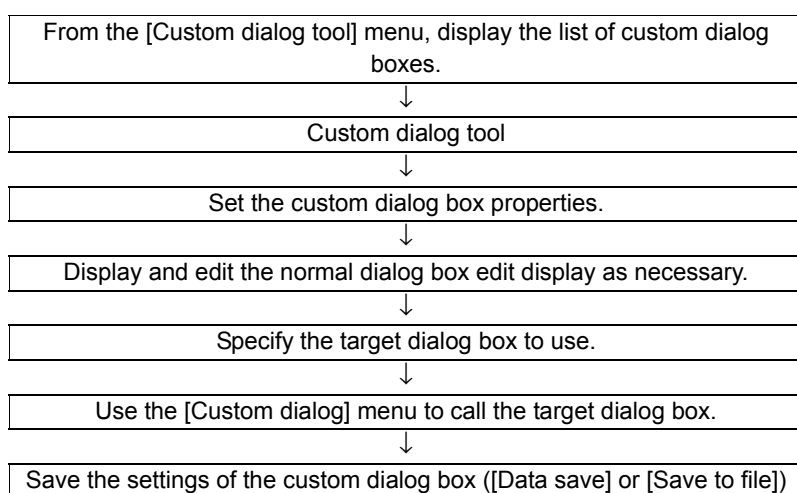

## 8-4-2 Custom Dialog Tool

Use the following procedure to create a custom dialog box.

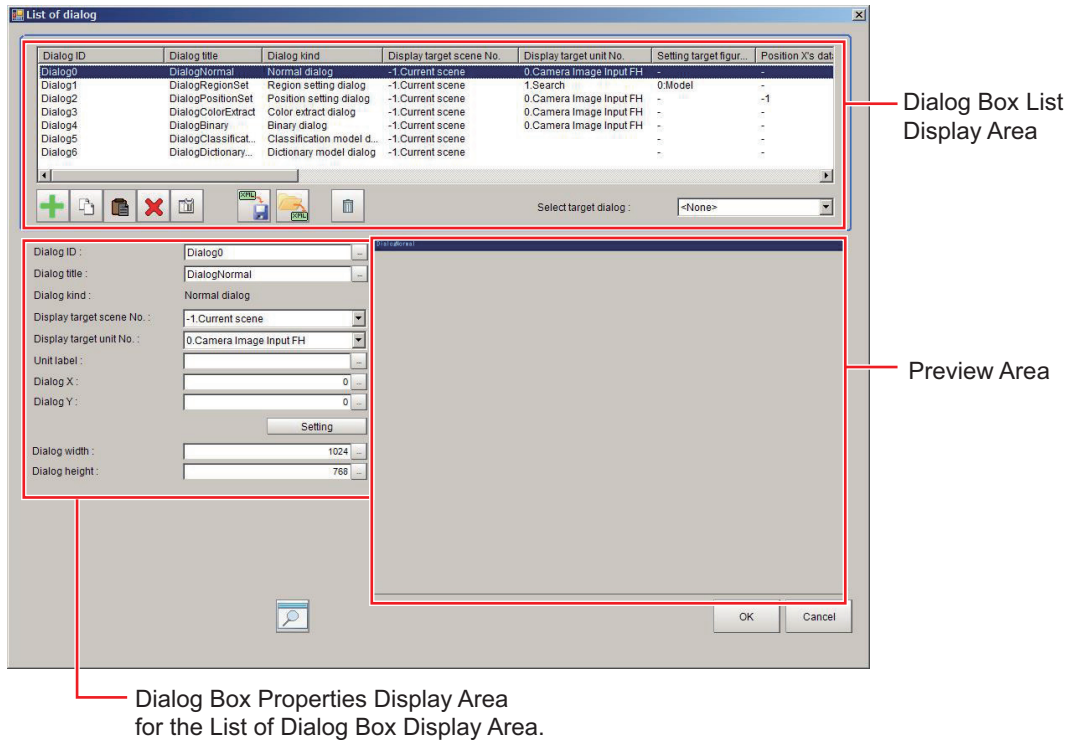

- 1 In the Main Window, select [Custom dialog tool] from the [Tool] menu.

The [List of dialog] display area is displayed. The Custom Dialog Tool has the following display areas: Dialog Box List Display Area, Dialog Box Properties Display Area, and Preview Area.



- Edit and Control Buttons for the List of Dialog Box Display Area.

Icon button	Function	Description
	Add dialog	Adds a dialog box. The [Select dialog] list is displayed.
	Copy dialog	Copies the selected dialog box.
	Paste dialog	Pastes the copied dialog box to the end of the list.
	Delete dialog	Deletes the selected dialog box.
	Edit normal dialog	If the selected dialog box is a normal dialog box, this button allows you to edit the contents that are displayed in the Edit Dialog Box Area. The [Edit Dialog] area is displayed.
	Save to dialog setting file	Saves the selected dialog box to a dialog box settings file (extension .xml).

Icon button	Function	Description
	Load from dialog setting file	Loads the dialog box from the specified dialog box settings file (extension.xml) into the list of dialog boxes.
	Initialization	Initialize scene settings.
	Preview	Displays a working preview of the selected dialog box for testing.

- 2** In the list of dialog boxes, click the [Add dialog] button ().  
The [Select dialog] list is displayed.

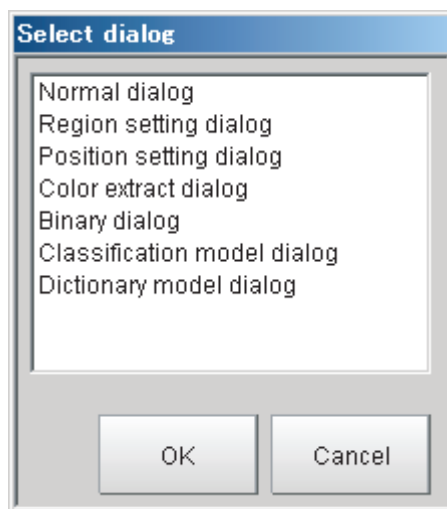

The types of dialog boxes that you can create are listed below.

Dialog kind	Description
Normal dialog	This is a custom dialog box that you create with numeric input boxes, buttons, and other items.
Region setting dialog	This dialog box sets the measurement region for a processing item, such as the region setting for Search and Defect.
Position setting dialog	This dialog box sets the reference of a processing item, such as the reference position for Search and Edge Position.
Color extract dialog	This dialog box sets the color of a processing item, such as the color setting in Edge Position.
Binary dialog	This dialog box sets the binary setting of a processing item, such as the binary filter in Labeling.
Classification model dialog	You can register multiple models for this dialog box, such as for the model registration of the Classification processing item.
Dictionary model dialog	You can register multiple models for this dialog box, such as for the model registration of the Model Dictionary processing item.

- 3** Select the kind of dialog box to add, and then click the [OK] button.  
The selected dialog box is added to the Dialog Box List Display Area.  
Select the added dialog box from the dialog box list. The settings for the selected dialog box are displayed in the Edit Dialog Box Area while an image of the dialog box is displayed in the Preview Area.
- 4** Edit the settings for the dialog box. Some settings are common for all dialog boxes, and some are specific to individual dialog boxes.

- Example: Dialog Box Properties Display Area for Color Extract Processing Item

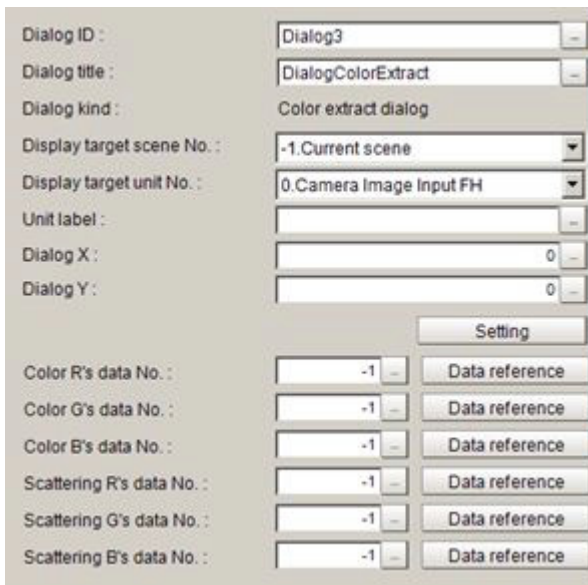

Refer to *Settings in the Dialog Box Properties Display Area* on page 8-71 for details on individual settings.



**Additional Information**

If [Dialog kind] is set to [Normal dialog], click the [Edit normal dialog] button (  ) to edit the dialog box.

Refer to *Editing a Normal Dialog Box* on page 8-73.

**5** Edit the settings, and click the [Preview] button (  ) as necessary to confirm the edited dialog box.

**6** Use the [Select dialog] list to specify the ID of the dialog box to open.

To open the dialog box that you specified in the [Select dialog], select [Custom dialog] from the [Tool] menu.

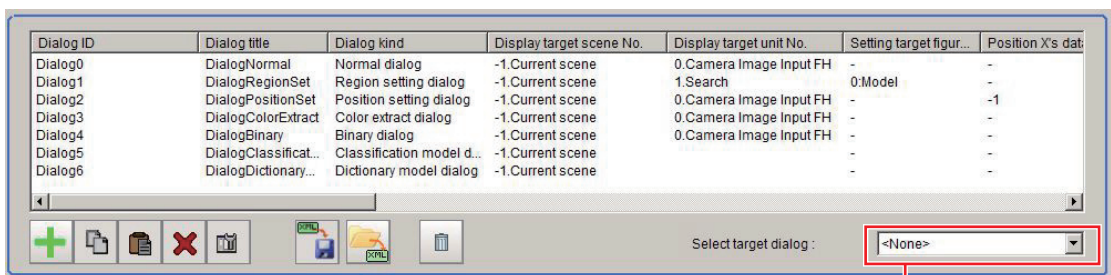

Select the target dialog box.

**7** When you have finished editing, click the [OK] button to exit the List of Dialog Box Display Area.

**8** Click [Data save] on the Main Window to save the settings.



**Additional Information**

To save the settings individually, click the [Save to dialog settings file] button (  ) to save the settings to a file. The saved file can be loaded with the [Load from dialog setting file] button





## Settings in the Dialog Box Properties Display Area

### ● Common Settings Area

Setting item	Setting value [Factory default]	Description
Dialog ID	The dialog box ID is set to a character string that is not assigned to any other dialog box.	The ID for the dialog box. To change the ID, click the [...] button and enter the desired characters.
Dialog title	A title that is based on the dialog box type is assigned.	The title for the dialog box. This appears in the title bar when the custom dialog box is displayed. To change the title, click the [...] button and enter the desired characters. Multilingual is also supported. For details, refer to 3-2-2 <i>Inputting Text</i> on page 3-7.
Dialog kind	---	The dialog box type is displayed.
Display target scene No.	Scene 0 to scene 127 *1 [Scene0]	This specifies the number of the scene for which to display the dialog box.
Display target unit No.	This is set to the unit that can be selected from the display target scene.	This specifies the number of the unit for which the dialog box is to be displayed instead of the default settings dialog box. The unit that can be specified depends on the type of the dialog box. Immediately after the dialog box is added, the unit with the lowest unit number out of the display target units in the display target scene is selected. If there is no display target unit, unit 0 is selected.
Unit label		This specifies the unit label for which the dialog box is to be displayed instead of the default setting dialog box. The unit that can be specified depends on the type of the dialog box. Beginning with searching the display target unit label and then the display target unit number will be searched if no corresponding unit label is found. If no display target unit is found, unit 0 is selected.
Dialog X Dialog Y	0 to 9999999 [0]	Sets the dialog display position with the coordinate system that the upper left position of the screen is (0,0). If the set coordinates are out of the screen, the dialog box is displayed at (0,0).
[Setting] Button		Displays the set contents as the custom dialog box. Adjust the dialog box position. After adjusting, the adjusted contents will be reflected to the dialog box position X, dialog position Y, dialog width, and dialog height by clicking the [Close] on the right end of the dialog title bar.

\*1. The setting for scene 0 to 1023 is available when the number of maximum scenes has been changed.



### Important

If you change the measurement flow after you create a custom dialog box, change the target unit number to match the edited measurement flow.

## ● Individual Setting Region

- Normal Dialog Box Setting Region

Setting item	Setting value [Factory default]	Description
Dialog width	100 to 1920 [1024]	Sets the width of the dialog box.
Dialog height	100 to 1080 [768]	Sets the height of the dialog box.

- Region Setting Dialog Box Setting Region

Setting item	Setting value [Factory default]	Description
Setting target figure No.	[0]	Specifies the figure number for the unit to use for region setting. The number that you can select depends on the unit that is specified.

- Position Setting Dialog Box Setting Region

Setting item	Setting value [Factory default]	Description
Position X's data No.	-1 to 999999999 [-1]	Specifies the data number on the X axis for the unit to use for position setting.
Position Y's data No.	-1 to 999999999 [-1]	Specifies the data number on the Y axis for the unit to use for position setting.
[Data reference] button	---	You can select the data number directly to enter it, or you can enter it with the [Data reference] button. Click the [Data reference] button to select the target data in the [Data reference] dialog box.

- Color Extract Dialog Box Setting Region

Setting item	Setting value [Factory default]	Description
Color R's data No.	-1 to 999999999 [-1]	Specifies the R's data number for the color to specify for the unit to use for color extraction.
Color G's data No.	-1 to 999999999 [-1]	Specifies the G's data number for the color to specify for the unit to use for color extraction.
Color B's data No.	-1 to 999999999 [-1]	Specifies the B's data number for the color to specify for the unit to use for color extraction.
Scattering R's data No.	-1 to 999999999 [-1]	Specifies the R's data number for the difference in the unit to use for color extraction.
Scattering G's data No.	-1 to 999999999 [-1]	Specifies the G's data number for the difference in the unit to use for color extraction.
Scattering B's data No.	-1 to 999999999 [-1]	Specifies the B's data number for the difference in the unit to use for color extraction.
[Data reference] button	---	You can select the data number directly to enter it, or you can enter it with the [Data reference] button. Click the [Data reference] button to select the target data in the [Data reference] dialog box.

- Binary Dialog Box Setting Region

Setting item	Setting value [Factory default]	Description
Binary upper's data No.	-1 to 999999999 [-1]	Specifies the upper data number for the unit to use for binary filtering.
Binary lower's data No.	-1 to 999999999 [-1]	Specifies the lower data number for the unit to use for binary filtering.
Binary reverse's data No.	-1 to 999999999 [-1]	Specifies the reverse data number for the unit to use for binary filtering.
[Data reference] button	---	You can select the data number directly to enter it, or you can enter it with the [Data reference] button. Click the [Data reference] button to select the target data in the [Data reference] dialog box.



## Editing a Normal Dialog Box



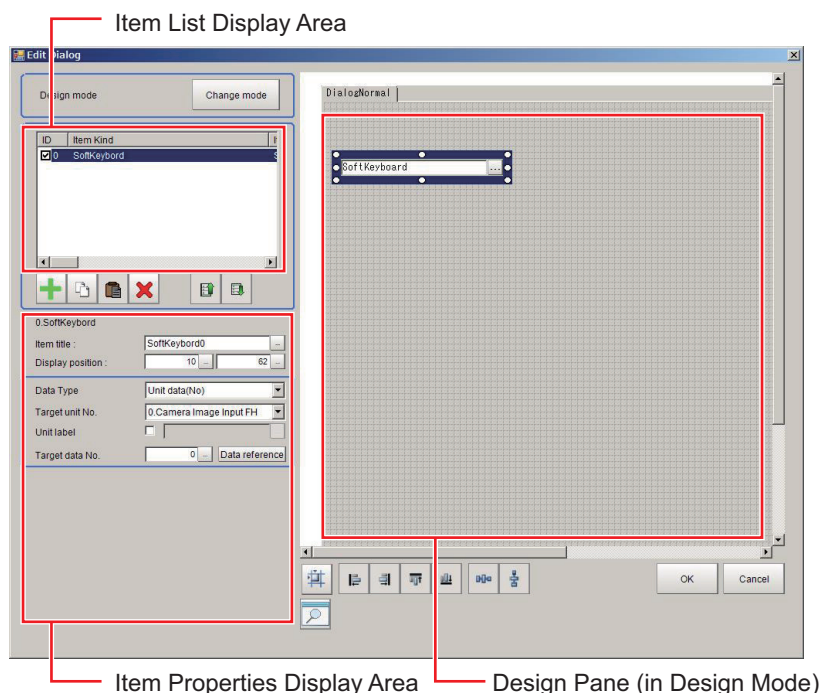

If [Dialog kind] is [Normal dialog], you can freely place objects, such as numeric entry boxes and buttons, anywhere in the Edit Dialog Box Area.

- 1 In the Dialog Box List Display Area, select a dialog box that is of the normal dialog box type.
- 2 Click the [Edit normal dialog] button (  ).  
The [Edit Dialog] area is displayed.



- Edit and Control Buttons for the Edit Normal Dialog Box Window.

Icon button	Function	Description
	Change mode	Switches between the Design Pane and the List Pane.
	Add item	Adds an item. The [Select item] dialog box is displayed. Click the [OK] button to add the selected item to the end of the list.

Icon button	Function	Description
	Copy item	Copies the item that is selected in the list.
	Paste item	Adds the copied item to the end of the list of items.
	Delete item	Deletes the item that is selected in the list.
	Move item up	Moves the selected item up one position in the list.
	Move item down	Moves the selected item down one position in the list.

**3** In the list of dialog boxes, click the [Add item] button ().  
The following [Select item] list is displayed.

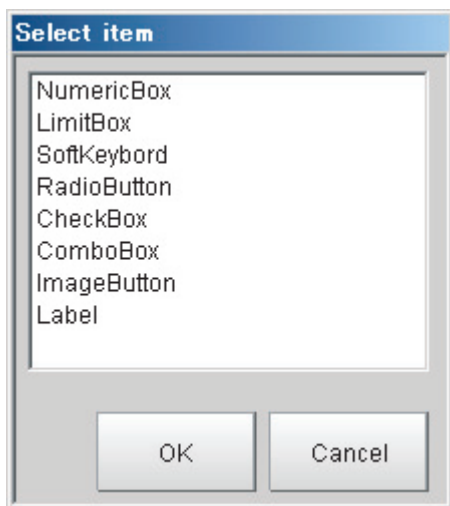

The types of items that you can place on a normal dialog box are listed below.

Item kind	Description
Numeric Box	This setting object is used to enter numeric values. From the processing items, select the numeric data to use as the target for the entered numeric value.
Limit Box	This setting object is used to enter upper and lower limits. From the processing items, select the upper/lower limit to use as the target for the entered numeric value.
Soft Keyboard	This setting object is used to enter characters. From the processing items, select the character string data to use as the target for the entered a character string.
Radio Button	This setting object is used to enter button options. From the processing items, select the data to use as the target for the entered selection result.
Check Box	This setting object is used to enter check box options. From the processing items, select the data to use as the target for the check box selection result.

Item kind	Description
Combo Box	This setting object is used to enter from a combo box. From the processing items, select the data to use as the target for the entered selection result. You can also set the items to display in the combo box.
Image button	This setting object is used to accept inputs from a button. Buttons can be placed in any desired position and are used to execute predetermined events when the button is clicked.
Label	This setting object is used to display characters. You can display any character string in any desired position.

**4** Select the kind of item to add, and then click the [OK] button.









The item is added to the Item List Display Area. At the same time, the added item is also displayed in the Design Pane.

**5** To move the position where an added item is displayed in the Design Pane, drag the item to the desired position.

Drag the  part of the border of the added item to change its display size.

Every item can be clicked, dragged, or selected as a group of items. Selected items are shown with a blue border.

The Design Pane of the Edit Normal Dialog Box Window has the following edit and control buttons.

Icon button	Function	Description
	Grid	Enable the following grid function. The grid lines will be displayed in the design window. When moving or expanding/reducing the selected item, this is moved or expanded/reduced along grid lines.
	Left	Aligns the left edges of the selected items to the left side of the first item that is selected.
	Right	Aligns the right edges of the selected items to the right side of the first item that is selected.
	Top	Aligns the top edges of the selected items to the top of the first item that is selected.
	Bottom	Aligns the bottom edges of the selected items to the bottom edge of the first item that is selected.
	Evenly space horizontally	Evenly adjusts the space on the left and right sides of the selected items.
	Evenly space vertically	Evenly adjusts the space on the tops and bottoms of the selected items.
	Preview	Displays a preview of the dialog box that is being created.



#### Additional Information

To view a list of the properties of an item in the Item List Display Area in Design Mode, click the [Change mode] button. The Item List Display Area changes to a list display.

Click the [Change mode] button in Edit Mode to return to the Design Mode.

**6** Every time you click an item in the list, that item changes between selected (inverted display) and not selected.

If only one item is selected (inverted display), the settings for that item type are displayed in the Edit Item Area.

**7** Edit the settings for the item. Some settings are common for all items, and some are specific to individual items.

Example: Item Properties Display Area for a Numeric Box

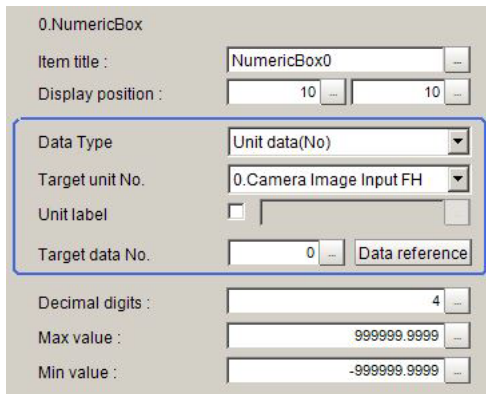

Refer to *Settings in the Item Properties Display Area* on page 8-76 that is described later in this section for details on all settings.

**8** When you have finished editing, click the [OK] button to exit the Edit Dialog Box Window.

● **Settings in the Item Properties Display Area**

- Common Settings Area

Setting item	Setting value [Factory default]	Description
Item title	This is set to a character string that is not assigned to any other item in the list when the item is added.	To change the title of the dialog box item, click the [...] button and enter the desired characters.
Display position	X: 0 to 1920, [-] Y: 0 to 1080, [-]	These are the coordinates of the upper left corner of the dialog box item. The upper left corner of the dialog box is 0, 0. The display position is also updated when you drag an item to a new position in the Design Pane.

- Individual Setting Region  
Numeric Box Setting Region

Setting item	Setting value [Factory default]	Description
Data Type	<ul style="list-style-type: none"> <li>• [Unit data (No)]</li> <li>• Unit data (ident)</li> <li>• System data</li> <li>• Scene variable</li> <li>• System variable</li> </ul>	Sets the unit specification method for targets for which to carry out the numeric setting. The setting details vary depending on the specification method.
Target unit No.	0 to No. of units in the display target scene - 1 [0]	This is available when [Unit data (No.)] or [Unit data (ident)] is selected in the "Data Type". Specifies the unit to be the target for the numeric setting. The units that are registered for the scene that is the target of the normal dialog box will appear in the combo box. Select the processing unit to set.

Setting item	Setting value [Factory default]	Description
Unit label	<ul style="list-style-type: none"> <li>• [Unchecked]</li> <li>• Checked</li> </ul>	<p>This is available when [Unit data (No.)] or [Unit data (ident)] is selected in the "Data Type".</p> <p>Sets when [Unit data (No.)] or [Unit data (ident)] is selected in the "Data Type".</p> <p>When using the unit label to specify the unit to be the target for the numeric setting, select this and set the unit label.</p>
Target data No.		<p>This is available when [Unit data (No.)] is selected in the "Data Type".</p> <p>Specifies the data to be the target for the numeric setting.</p> <p>Enter the data number for the unit that is specified by the "Target unit No.".</p>
[Data reference] button		<p>This is available when [Unit data (No.)] is selected in the "Data Type".</p> <p>You can select the data number directly to enter it, or you can enter it with the [Data reference] button.</p> <p>Click the [Data reference] button to select the target data in the [Data reference] dialog box.</p>
Data ident		<p>Sets when [Unit data (ident)] is selected in the "Data Type".</p> <p>Use the unit data (identifier name) to specify the unit to be the target for the numeric setting.</p>
Ident 0 Ident 1		<p>These are available when [System data] is selected in the "Data Type".</p> <p>Specifies the system data to be the target for the numeric setting using the identifier information 0 and identifier information 1.</p> <p>(Refer to the <i>Vision System FH/FZ5 Series Macro Customize Functions Programming Manual</i> (Cat No. Z367-E1) system data list.)</p>
Scene variable		<p>This is available when [Scene variable] is selected in the "Data Type".</p> <p>Specifies the scene variable to be the target for the numeric setting using the scene variable name.</p>
System variable		<p>This is available when [System variable] is selected in the "Data Type".</p> <p>Specifies the system variable to be the target for the numeric setting using the system variable name.</p>
Decimal digits	0 to 4 [4]	Enter the number of digits after the decimal place that can be entered by the numeric setting.
Max value	-999999.9999 to 999999.9999 [999999.9999]	Enter the maximum value that can be entered with the numeric setting.
Min value	-999999.9999 to 999999.9999 [-999999.9999]	Enter the minimum value that can be entered with the numeric setting.

- Limit Box Setting Region

Setting item	Setting value [Factory default]	Description
Lower limit Upper limit	<ul style="list-style-type: none"> <li>• [Unit data (No.)]</li> <li>• Unit data (identifier name)</li> <li>• System data</li> <li>• Scene variable</li> <li>• System variable</li> </ul>	<p>Sets the unit specification method for targets for which to carry out upper/lower limits settings.</p> <p>The settings details vary depending on specification methods.</p>
Unit no	0 to Number of units in the display target scene - 1 [0]	<p>Sets when [Unit data (No.)] or [Unit data (ident)] is selected in the “Lower limit”/“Upper limit”.</p> <p>Use the unit number to specify the unit to be the target for the upper/lower limit setting.</p> <p>The units that are registered for the scene that is the target of the normal dialog box will appear in the combo box.</p> <p>Select the processing unit to set.</p>
Unit label	<ul style="list-style-type: none"> <li>• [Unchecked]</li> <li>• Checked</li> </ul>	<p>Sets when [Unit data (No.)] or [Unit data (identifier name)] is selected in the “Lower limit”/“Upper limit”.</p> <p>If using the unit label to specify the unit to be the target for the upper/lower limit setting, select this, and set the unit label.</p>
Data no	0 to 9999999 [0]	<p>Sets when [Unit data (No.)] is selected in the “Lower limit”/“Upper limit”.</p> <p>Specify the data to be the target for the upper/lower limit settings using the data number.</p> <p>Enter the data number for the unit that is specified by the target unit number.</p>
[Data reference] button		<p>Sets when [Unit data (No.)] is selected in the “Lower limit”/“Upper limit”.</p> <p>You can select the data number by directly entering it, or you can enter it with the [Data reference] button.</p> <p>Click the [Data reference] button to select the target data in the [Data reference] dialog box.</p>
Data ident		<p>Sets when [Unit data (ident)] is selected in the “Lower limit”/“Upper limit”.</p> <p>Use the unit identifier name to specify the unit to be the target for the upper/lower limit setting.</p>
ident 0 ident 1		<p>Sets when [System data] is selected in the “Lower limit”/“Upper limit”.</p> <p>Specify the system data to be the target for the upper/lower limit setting using the identifier information 0 and identifier information 1.</p> <p>(Refer to the <i>Vision System FH/FHV/FZ5 Series Macro Customize Functions Programming Manual</i> (Cat No. Z367-E1) system data list.)</p>
Scene variable		<p>Sets when [Scene variable] is selected in the “Lower limit”/“Upper limit”.</p> <p>Specify the scene variable to be the target for the upper/lower limit settings using the scene variable name.</p>
System variable		<p>Sets when [System variable] is selected in the “Lower limit”/“Upper limit”.</p> <p>Specify the system variable to be the target for the upper/lower limit settings using the system variable name.</p>



Setting item	Setting value [Factory default]	Description
Decimal digits	0 to 4 [4]	Enter the number of digits after the decimal place that can be entered by the upper/lower limit setting.
Max value	-999999.9999 to 999999.9999 [999999.9999]	Enter the maximum value that can be entered with the upper/lower limit setting.
Min value	-999999.9999 to 999999.9999 [-999999.9999]	Enter the minimum value that can be entered with the upper/lower limit setting.



### Important

- The limit box setting region sets an upper and lower limit for one data item. Accordingly, ensure upper and lower and limits for different data are not set.
- If you change the measurement flow after you create a custom dialog box, change the target unit number to match the edited measurement flow.

- Soft Keyboard Setting Region

Parameter	Set value [Factory default]	Description
Data Type	<ul style="list-style-type: none"> <li>• [Unit data (No.)]</li> <li>• Unit data (ident)</li> <li>• System data</li> <li>• Scene variable</li> <li>• System variable</li> </ul>	<p>Sets the unit specification method for targets for which to carry out character string settings.</p> <p>The settings details vary depending on specification methods.</p>
Target Unit No.	0 to Number of units in the display target scene - 1 [0]	<p>Sets when [Unit data (No.)] or [Unit data (ident)] is selected in the "Data Type".</p> <p>Use the unit number to specify the unit to be the target for the character string setting.</p> <p>The units that are registered for the scene that is the target of the normal dialog box will appear in the combo box.</p> <p>Select the processing unit to set.</p>
Unit label	<ul style="list-style-type: none"> <li>• [Unchecked]</li> <li>• Checked</li> </ul>	<p>Sets when [Unit data (No.)] or [Unit data (ident)] is selected in the "Data Type".</p> <p>If using the unit label to specify the unit to be the target for the character string setting, select this, and set the unit label.</p>
Target data No.	0 to 9999999 [0]	<p>Sets when [Unit data (No.)] is selected in the "Data Type".</p> <p>Specify the data to be the target for the character string setting using the data number.</p> <p>Enter the data number for the unit that is specified by the target unit number.</p>
[Data reference] button		<p>Sets when [Unit data (No.)] is selected in the "Data Type".</p> <p>You can select the data number by directly entering it, or you can enter it with the [Data reference] button.</p> <p>Click the [Data reference] button to select the target data in the [Data reference] dialog box.</p>

Parameter	Set value [Factory default]	Description
ident 0 ident 1		Sets when [System data] is selected in the "Data Type". Specify the system data to be the target for the character string setting using the identifier information 0 and identifier information 1. (Refer to the <i>Vision System FH/FZ5 Series Macro Customize Functions Programming Manual</i> (Cat No. Z367-E1) system data list.)
Scene variable		Sets when [Scene variable] is selected in the "Data Type". Specify the scene variable to be the target for the character string setting using the scene variable name.
System variable		Sets when [System variable] is selected in the "Data Type". Specify the system variable to be the target for the character string setting using the system variable name.



### Important

If you change the measurement flow after you create a custom dialog box, change the target unit number to match the edited measurement flow.

## Radio Button Setting Region

Parameter	Set value [Factory default]	Description
Data Type	<ul style="list-style-type: none"> <li>• [Unit data (No.)]</li> <li>• Unit data (ident)</li> <li>• System data</li> <li>• Scene variable</li> <li>• System variable</li> </ul>	<p>Sets the unit specification method for targets for which to carry out radio button settings.</p> <p>The settings details vary depending on specification methods.</p>
Target Unit No.	0 to Number of units in the display target scene - 1 [0]	<p>Sets when [Unit data (No.)] or [Unit data (ident)] is selected in the "Data Type".</p> <p>Use the unit number to specify the unit to be the target for the radio button setting.</p> <p>The units that are registered for the scene that is the target of the normal dialog box will appear in the combo box.</p> <p>Select the processing unit to set.</p>
Unit label	<ul style="list-style-type: none"> <li>• [Unchecked]</li> <li>• Checked</li> </ul>	<p>Sets when [Unit data (No.)] or [Unit data (ident)] is selected in the "Data Type".</p> <p>If using the unit label to specify the unit to be the target for the radio button setting, select this and set the unit label.</p>
Target data No.	0 to 9999999 [0]	<p>Sets when [Unit data (No.)] is selected in the "Data Type".</p> <p>Specify the data to be the target for the radio button setting using the data number.</p> <p>Enter the data number for the unit that is specified by the target unit number.</p>
[Data reference] button		<p>Sets when [Unit data (No.)] is selected in the "Data Type".</p> <p>You can select the data number by directly entering it, or you can enter it with the [Data reference] button.</p> <p>Click the [Data reference] button to select the target data in the [Data reference] dialog box.</p>
Data ident		<p>Sets when [Unit data (ident)] is selected in the "Data Type".</p> <p>Use the unit data (identifier name) to specify the unit to be the target for the radio button setting.</p>
ident 0 ident 1		<p>Sets when [System data] is selected in the "Data Type".</p> <p>Specify the system data to be the target for the radio button setting using the identifier information 0 and identifier information 1.</p> <p>(Refer to the <i>Vision System FH/FHV/FZ5 Series Macro Customize Functions Programming Manual</i> (Cat No. Z367-E1) system data list.)</p>
Scene variable		<p>Sets when [Scene variable] is selected in the "Data Type".</p> <p>Specify the scene variable to be the target for the radio button setting using the scene variable name.</p>
System variable		<p>Sets when [System variable] is selected in the "Data Type".</p> <p>Specify the system variable to be the target for the radio button setting using the system variable name.</p>
Value	0 to 9999999 [0]	<p>Enters the numeric value to set in the target data when the radio button is selected.</p> <p>The numeric value to be set here is the set value for that selected radio button that is applied to the data for the target data number when the operator changes the radio button selection on the actual user dialog box.</p>

**Important**

If you change the measurement flow after you create a custom dialog box, change the target unit number to match the edited measurement flow.

## Check Box Setting Region

Parameter	Set value [Factory default]	Description
Data Type	<ul style="list-style-type: none"> <li>• [Unit data (No.)]</li> <li>• Unit data (ident)</li> <li>• System data</li> <li>• Scene variable</li> <li>• System variable</li> </ul>	<p>Sets the unit specification method for targets for which to carry out check box settings.</p> <p>The settings details vary depending on specification methods.</p>
Target Unit No.	0 to Number of units in the display target scene - 1 [0]	<p>Sets when [Unit data (No.)] or [Unit data (ident)] is selected in the "Data Type".</p> <p>Use the unit number to specify the unit to be the target for the check box setting.</p> <p>The units that are registered for the scene that is the target of the normal dialog box will appear in the combo box.</p> <p>Select the processing unit to set.</p>
Unit label	<ul style="list-style-type: none"> <li>• [Unchecked]</li> <li>• Checked</li> </ul>	<p>Sets when [Unit data (No.)] or [Unit data (ident)] is selected in the "Data Type".</p> <p>If using the unit label to specify the unit to be the target for the check box setting, select this and set the unit label.</p>
Target data No.	0 to 9999999 [0]	<p>Sets when [Unit data (No.)] is selected in the "Data Type".</p> <p>Specify the data to be the target for the check box setting using the data number.</p> <p>Enter the data number for the unit that is specified by the target unit number.</p>
[Data reference] button		<p>Sets when [Unit data (No.)] is selected in the "Data Type".</p> <p>You can select the data number by directly entering it, or you can enter it with the [Data reference] button.</p> <p>Click the [Data reference] button to select the target data in the [Data reference] dialog box.</p>
Data ident		<p>Sets when [Unit data (ident)] is selected in the "Data Type".</p> <p>Use the unit data (identifier name) to specify the unit to be the target for the check box setting.</p>
ident 0 ident 1		<p>Sets when [System data] is selected in the "Data Type".</p> <p>Specify the system data to be the target for the radio button setting using the identifier information 0 and identifier information 1.</p> <p>(Refer to the <i>Vision System FH/FZ5 Series Macro Customize Functions Programming Manual</i> (Cat No. Z367-E1) system data list.)</p>
Scene variable		<p>Sets when [Scene variable] is selected in the "Data Type".</p> <p>Specify the scene variable to be the target for the radio button setting using the scene variable name.</p>
System variable		<p>Sets when [System variable] is selected in the "Data Type".</p> <p>Specify the system variable to be the target for the check box setting using the system variable name.</p>

**Important**

If you change the measurement flow after you create a custom dialog box, change the target unit number to match the edited measurement flow.

## Combo Box Setting Region

Parameter	Set value [Factory default]	Description
Data Type	<ul style="list-style-type: none"> <li>• [Unit data (No.)]</li> <li>• Unit data (ident)</li> <li>• System data</li> <li>• Scene variable</li> <li>• System variable</li> </ul>	<p>Sets the unit specification method for targets for which to carry out combo box settings.</p> <p>The settings details vary depending on specification methods.</p>
Target Unit No.	0 to Number of units in the display target scene - 1 [0]	<p>Sets when [Unit data (No.)] or [Unit data (ident)] is selected in the "Data Type".</p> <p>Use the unit number to specify the unit to be the target for the combo box setting.</p> <p>The units that are registered for the scene that is the target of the normal dialog box will appear in the combo box.</p> <p>Select the processing unit to set.</p>
Unit label	<ul style="list-style-type: none"> <li>• [Unchecked]</li> <li>• Checked</li> </ul>	<p>Sets when [Unit data (No.)] or [Unit data (ident)] is selected in the "Data Type".</p> <p>If using the unit label to specify the unit to be the target for the combo box setting, select this and set the unit label.</p>
Target data No.	0 to 9999999 [0]	<p>Sets when [Unit data (No.)] is selected in the "Data Type".</p> <p>Specify the data to be the target for the combo box setting using the data number.</p> <p>Enter the data number for the unit that is specified by the target unit number.</p>
[Data reference] button		<p>Sets when [Unit data (No.)] is selected in the "Data Type".</p> <p>You can select the data number by directly entering it, or you can enter it with the [Data reference] button.</p> <p>Click the [Data reference] button to select the target data in the [Data reference] dialog box.</p>
Data ident		<p>Sets when [Unit data (ident)] is selected in the data type.</p> <p>Use the unit data (identifier name) to specify the unit to be the target for the combo box setting.</p>
ident 0 ident 1		<p>Sets when [System data] is selected in the "Data Type".</p> <p>Specify the system data to be the target for the combo box setting using the identifier information 0 and identifier information 1. (Refer to <i>Vision System FH/FZ5 Series Macro Customize Functions Programming Manual</i> (Cat No. Z367-E1) system data list.)</p>
Scene variable		<p>Sets when [Scene variable] is selected in the "Data Type".</p> <p>Specify the scene variable to be the target for the radio button setting using the scene variable name.</p>
System variable		<p>Sets when [System variable] is selected in the "Data Type".</p> <p>Specify the system variable to be the target for the radio button setting using the system variable name.</p>
[Item setting] button		<p>Sets the item name and the data that corresponds to the item name to display in the combo box. Make sure the number of items and the number of data match.</p> <ul style="list-style-type: none"> <li>• Items: Enter the name of the items to display in the combo box.</li> <li>• Data No.: Enter the target data numbers that correspond to each item in the combo box.</li> </ul>

**Important**

If you change the measurement flow after you create a custom dialog box, change the target unit number to match the edited measurement flow.

## Image Button Setting Region

Parameter	Set value [Factory default]	Description
Event	<ul style="list-style-type: none"> <li>• [Apply and close]</li> <li>• Close</li> <li>• Other dialog</li> <li>• Apply and change dialog</li> <li>• Change dialog</li> <li>• Apply</li> <li>• Get current value</li> <li>• Set Value</li> </ul>	<p>Apply and close: Apply the settings and close the dialog.</p> <p>Close: Close the dialog.</p> <p>Other dialog: Open a child window for the new dialog.</p> <p>Apply and change dialog: Apply the settings and open the specified dialog.</p> <p>Change dialog: Open the specified dialog without applying the settings.</p> <p>Apply: Apply the settings.</p> <p>Get current value: Restore the data before application.</p> <p>Set value: Set the specified value to the specified data.</p>
Target dialog ID		<p>This is available when [Other dialog], [Apply and change dialog], or [Change dialog] is selected in the "Event".</p> <p>When clicking the button, select the ID for the dialog box to launch.</p>
Data Type	<ul style="list-style-type: none"> <li>• [Unit data (No.)]</li> <li>• Unit data (ident)</li> <li>• System data</li> <li>• Scene variable</li> <li>• System variable</li> </ul>	<p>The following items (from here to "System valuable") are available when [Set value] is selected in the "Event".</p> <p>Sets the unit specification method for targets for which to carry out button settings.</p> <p>The settings details vary depending on specification methods.</p>
Target data No.		<p>This is available when [Unit data (No.)] is selected in the "Data Type".</p> <p>Specifies the data to be the target for the button setting.</p> <p>Enter the data number for the unit that is specified by the "Target unit No.".</p>
[Data reference] button		<p>This is available when [Unit data (No.)] is selected in the "Data Type".</p> <p>You can select the data number directly to enter it, or you can enter it with the [Data reference] button.</p> <p>Click the [Data reference] button to select the target data in the [Data reference] dialog box.</p>
Data ident		<p>Sets when [Unit data (ident)] is selected in the "Data Type".</p> <p>Use the unit data (identifier name) to specify the unit to be the target for the button setting.</p>
Ident 0 Ident 1		<p>These are available when [System data] is selected in the "Data Type".</p> <p>Specifies the system data to be the target for the button setting using the identifier information 0 and identifier information 1.</p> <p>(Refer to <i>Vision System FH/FZ5 Series Macro Customize Functions Programming Manual</i> (Cat No. Z367-E1) system data list.)</p>
Scene variable		<p>This is available when [Scene variable] is selected in the "Data Type".</p> <p>Specifies the scene variable to be the target for the button setting using the scene variable name.</p>
System variable		<p>This is available when [System variable] is selected in the "Data Type".</p> <p>Specifies the system variable to be the target for the button setting using the system variable name.</p>
Set value		Sets a value.

## Label Setting Region

Parameter	Set value [Factory default]	Description
Data Type	<ul style="list-style-type: none"> <li>• [Unit data (No)]</li> <li>• Unit data (ident)</li> <li>• System data</li> <li>• Scene variable</li> <li>• System variable</li> </ul>	Sets the unit specification method for targets for which to carry out the label setting. The setting details vary depending on the specification method. Setting of title The place where "{0}" in character string is the data notation set by data type.
Target unit No.	0 to No. of units in the display target scene – 1 [0]	This is available when [Unit data (No.)] or [Unit data (ident)] is selected in the "Data Type". Specifies the unit to be the target for the label setting. The units that are registered for the scene that is the target of the normal dialog box will appear in the combo box. Select the processing unit to set.
Unit label	<ul style="list-style-type: none"> <li>• [Unchecked]</li> <li>• Checked</li> </ul>	This is available when [Unit data (No.)] or [Unit data (ident)] is selected in the "Data Type". When using the unit label to specify the unit to be the target for the label setting, select this and set the unit label.
Target data No.	0 to 9999999 [0]	This is available when [Unit data (No.)] is selected in the "Data Type". Specifies the data to be the target for the label setting. Enter the data number for the unit that is specified by the "Target unit No.".
[Data reference] button		This is available when [Unit data (No.)] is selected in the "Data Type". You can select the data number directly to enter it, or you can enter it with the [Data reference] button. Click the [Data reference] button to select the target data in the [Data reference] dialog box.
Data ident		Sets when [Unit data (ident)] is selected in the "Data Type". Use the unit data (identifier name) to specify the unit to be the target for the label setting.
Ident 0 Ident 1		These are available when [System data] is selected in the "Data Type". Specifies the system data to be the target for the label setting using the identifier information 0 and identifier information 1. (Refer to <i>Vision System FH/FZ5 Series Macro Customize Functions Programming Manual</i> (Cat No. Z367-E1) system data list.)
Scene variable		This is available when [Scene variable] is selected in the "Data Type". Specifies the scene variable to be the target for the label setting using the scene variable name.
System variable		This is available when [System variable] is selected in the "Data Type". Specifies the system variable to be the target for the label setting using the system variable name.

**Important**

If you change the measurement flow after you create a custom dialog box, change the target unit number to match the edited measurement flow.

### 8-4-3 Launching Your Custom Dialog Box

- 1** In the Main Window, select [Custom dialog] from the [Tool] menu.  
The custom dialog box that is set for [Select target dialog] is displayed.
- 2** Change the setting for the processing unit in the custom dialog box that is displayed



# Saving/Loading Data

<b>9-1</b>	<b>Saving Data to the FH series/FZ5 series</b>	<b>9-3</b>
9-1-1	About Saving Areas	9-3
9-1-2	External Drive Names	9-5
9-1-3	Using External Storage Devices	9-6
9-1-4	Shared Folder on a Computer Connected to the Network	9-6
<b>9-2</b>	<b>Saving Settings Data to the Flash Memory</b>	<b>9-7</b>
<b>9-3</b>	<b>Saving Setting Data to the Controller RAMDisk or an External Storage Device</b>	<b>9-8</b>
<b>9-4</b>	<b>Saving Logged Images in the Controller Memory (RAM) to a RAMDisk or an External Storage Device</b>	<b>9-10</b>
<b>9-5</b>	<b>Copying or Moving Files between the Controller RAMDisk and an External Storage Device</b>	<b>9-12</b>
<b>9-6</b>	<b>Loading Settings Data from the Controller RAMDisk or an External Storage Device to the Sensor Controller</b>	<b>9-13</b>
<b>9-7</b>	<b>Backing up Sensor Controller Setting Data [Configuration Copy]</b>	<b>9-15</b>
9-7-1	Before Backing up	9-15
9-7-2	Backing up Sensor Controller Settings	9-17
9-7-3	Restoring Saved Settings	9-27
9-7-4	Troubleshooting	9-30
<b>9-8</b>	<b>Copying Settings for Each Line in Multi-line Random-trigger Mode [Line Maintenance]</b>	<b>9-32</b>
9-8-1	Before use of Line Maintenance	9-33
9-8-2	Line Maintenance tool operations	9-36
9-8-3	Operating with Functional Limitations	9-44
9-8-4	Troubleshooting	9-47
<b>9-9</b>	<b>Saving Image Files to a RAMDisk or an External Storage Device [Image File Save]</b>	<b>9-48</b>
<b>9-10</b>	<b>Outputting a list of Scene Data Setting Values [Setting Values Download/Upload Tools]</b>	<b>9-51</b>
9-10-1	Downloading Setting Values	9-51
9-10-2	About Downloaded CSV Files	9-52
9-10-3	Uploading Setting Values	9-53

**9-11 Saving/Loading Layout Settings [Layout Upload, Download Tool] . . . . . 9-55**

# 9-1 Saving Data to the FH series/FZ5 series

This section describes how to save and load setting data and logged image data.

## 9-1-1 About Saving Areas

The following saving areas can be used with the Sensor Controller.

Saving area		Description	Save operation
Controller	Flash memory in the Controller	The settings data (system data, scene data, and scene group data) is saved to this area when you click the [Data save] button. Data is held even after the power supply is turned OFF. When you restart the Controller, the Controller loads and enables the settings data in the flash memory.	[Function] – [Data save] or the [Data save] button
	Controller memory (RAM)	This is the area where images are temporarily stored when logging images using the logging function. This memory is a ring memory. Images will be overwritten starting with the oldest image if the maximum number of save images is exceeded.	[Function] – [Save to file] or [Function] – [Screen capture]
	RAM disk in the Controller	<ul style="list-style-type: none"> <li>You can use this memory as a temporary file save destination.</li> <li>The data is cleared when you turn OFF the power supply to the Controller. As this is memory inside the Controller, files can be saved and read faster than when using external storage.</li> <li>The RAMDisk memory is as follows. <ul style="list-style-type: none"> <li>FH series/FZ5-800/1100/1200 series: 256 MB</li> <li>FZ5-L series/FZ5-600 series: 40 MB</li> </ul> </li> <li>The RAMDisk data can be sent to or received from external devices using FTP.</li> </ul>	
External storage	USB memory	This memory is used to back up setting data as a precaution, to copy setting data to another Controller, and to load data to a computer.	
	SD memory card (FH series only)		
	microSD card (FHV series only)		
	Shared folder on a computer connected to the network		

The following table shows the data that is retained or cleared and the data that is saved when the power supply is turned OFF.

Saving area		At power OFF	Target data				
			Settings data (system data, scene data, and scene group data)	Logged images	Last input image and last NG image	Logged data (measurement data)	Capture image
Sensor Controller	Flash memory of the Controller	Retained	OK	---	---	---	---
	Controller memory (RAM)	Cleared	---	OK <sup>*1</sup>			
	RAM disk	Cleared					
External storage	USB memory	Retained	OK	OK <sup>*2</sup>	OK	OK	OK
	SD memory card						
	microSD card						
	Shared folder on a computer connected to the network						

\*1. If images are being logged by the system, select [Other] – [Logging setting] under the System Settings and set the destination for logged images to [Save to memory].

\*2. If images are being logged by the system, select [Other] – [Logging setting] under the System Settings and set the destination for logged images to [Save to memory + file].



### Important

#### During data transfer, do not turn OFF the power supply.

- When a message indicating that processing such as saving or loading is in progress is displayed, do not restart the Controller or turn OFF the power supply. Data will be corrupted and the system will not work properly at the next startup.
- Do not remove external storage devices while data is being saved or loaded. The operation of the Controller may corrupt the data or external storage.
- Do not change the file name extension of saved files. If you change the extension, the file cannot be loaded as setting data. In addition, if setting data in which the extension was changed is loaded, the system may not work properly later.
- Depending on the settings, saving may fail due to insufficient external storage space. If saving fails and the error message “Please check” appears, check to see if there is unnecessary data in the external storage and save the data after the unnecessary data has been deleted.
- The file system supported by USB memory or SD memory card differ by the Sensor Controller.

Format USB memory or SD memory card according to the Sensor Controller series.

Sensor Controller	FAT32	NTFS	exFAT
FH/FHV series	OK	OK	OK
FZ5-800/1100/1200 series	OK	OK	---
FZ5-L series/FZ5-600 series	OK	---	---

## 9-1-2 External Drive Names

### ● Drive Names for USB Devices

Sensor Controller has two or four USB connectors. If more than one USB memory device is inserted, specify the USB memory drive that is to be the destination.

- FZ5-L series/FZ5-600 series

The drive names of USB memory devices are USBDisk, USBDisk2, USBDisk3 and USBDisk4 according to the sequence in which devices are inserted into the Controller.

If the Controller, however, is started with more than one USB memory device inserted, drive names will be assigned based on the ports in which the USB memory devices are inserted. Depending on the Controller type, USB memory devices are recognized and drive name are assigned using the following sequence.

- Controller with Integrated Panel
  - 1: Left side on the front - 2: Right side on the front - 3: Front on the side - 4: Back on the side
- Box-type Controller
  - 1: Lower left on the front - 2: Lower right on the front - 3: Upper left on the front - 4: Upper right on the front
- FH series/FZ5-800/1100/1200 series
 

USB devices are assigned as drives E:\, F:\, G:\ and H:\ in the order in which they are inserted.

### ● Drive Name of SD Memory Card

When FH series Sensor Controller is used, "M:\\" is assigned as a fixed drive.



#### Important

##### Box-type Controllers

If USB memory devices are separately connected to adjacent USB connectors, the contact between USB memory devices may possibly lead to failure or damage.

##### USB hub

When connect the USB memory using USB hub, the drive name can be differ as a previous saved. If you want fixed name, directly connect the USB port without USB hub.

### 9-1-3 Using External Storage Devices

Use the following procedure to remove the external storage device.

This procedures are available in FH series/FZ5-800/1100/1200 series only.

- 1** In the Main Window, select [System information] from the [Function] menu.  
The system information is displayed.
- 2** Click [Drive information].  
Each drive information is displayed.  
If an external storage device is inserted, the [Eject] button is displayed.

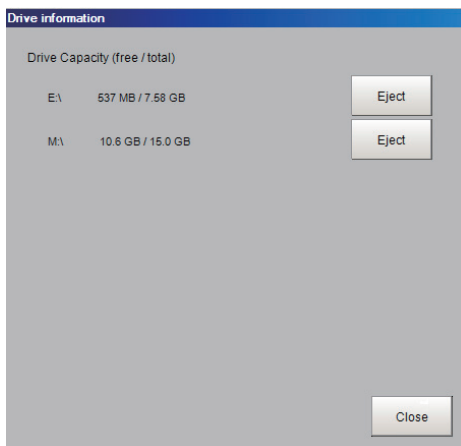

- 3** To remove the USB memory device, click the [Eject] button.
  - When the USB Memory Can Be Removed  
If the removal failed, wait until the external storage device is no longer being accessed and then try removing the device again.

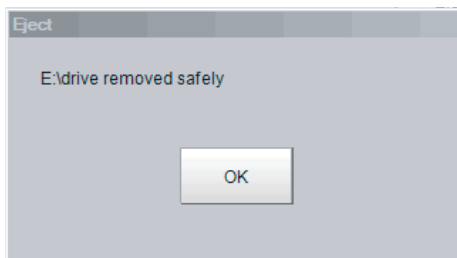

#### Important

Never try to remove the external storage device while the external storage is being accessed. A critical failure may occur.

### 9-1-4 Shared Folder on a Computer Connected to the Network

You can setup a network drive in the system settings. This allows the Sensor Controller to handle the hard drive on a computer that is connected to the local area network as an external storage device.

Refer to 4-13 *Setting Network Drive [Network Drive Setting]* on page 4-53.

## 9-2 Saving Settings Data to the Flash Memory

This section describes the procedure to save settings data (system data, scene data, and scene group data) in the flash memory of the Sensor Controller. Make sure to save setting data when settings have been changed.

Every time you restart the Sensor Controller, the data in the memory is loaded and enabled.



### Important

- If [Save to file] is performed for [System + scene group 0 data], the data being saved will also be saved to the Controller's flash memory at the same time. Do not turn OFF the power supply during this process. The Controller may not start up properly the next time it is turned ON.
- During data transfer to external storage, do not remove the external storage device until the transfer is completed. Data and the external storage may be corrupted.

**1** For FZ5-L series/FZ5-600 series:  
The system data and Scene group 0 data are saved to the Controller's flash memory and Scene groups 1 to 31 data is saved to the external storage.

**2** Click [Save to file] on the toolbar in the Main Window.  
A confirmation message is displayed.

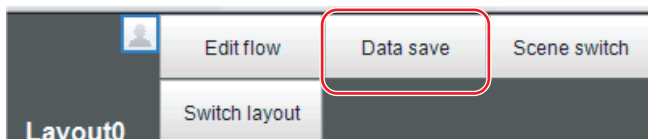

**3** Click [OK].

For FZ5-L series/FZ5-600 series:

The system data and Scene group 0 data are saved to the Controller's flash memory.

Scene groups 1 to 31 data is saved to the external storage.

(FH series or FZ5-800/1100/1200 series: All data is saved in the flash memory in the Controller by default.)

If you connect more than one the external storage to the Controller, confirm in the File Explorer window that the external storage you wish to save the Scene group data to is recognized as a drive.

Refer to *9-1-2 External Drive Names* on page 9-5.



### Additional Information

If an external storage device is not inserted, a confirmation message is displayed.

If [OK] is clicked, only system data and data from scene group 0 are saved in the Controller's flash memory.

## 9-3 Saving Setting Data to the Controller RAMDisk or an External Storage Device

Setting data files are saved to the RAMDisk or to an external storage device. The following table lists the data that can be saved.

Data	Description
System data (*.ini)	Indicates the shared setting data, i.e. [System] menu.
Scene data (*.scn)	Indicates each setting data, i.e. unit setting value, Scene order, layout or size of Image Pane.
Scene group data (*.sgp)	Indicates data including 128 Scene.
System + Scene group 0 data (*.bkd)	Indicates both system data and Scene group 0 data.



### Important

- Do not try to restart, turn OFF the power source, or remove the external storage during saving data. Data may be corrupted and will not be performed correctly next launching. In particular, when the target data of [Data save] is System + Scene group 0 as it is saved to the flash memory of Sensor Controller simultaneously.
- If the software version to load is not older than the software version which is saved the setting data, it is possible not to be loaded the setting data file.



### Additional Information

When [Save to file] is executed, the data to save is also saved in the Controller (except scene group data 1 to 31).

- 1 To save to a USB memory device (or an SD memory card), insert the USB memory device (or SD memory card) in the Controller.
- 2 In the Main Window, select [Save to file] from the [Function] menu.  
The [Save to file] dialog box is displayed.
- 3 Click the [Setting data] button to select the data to save.

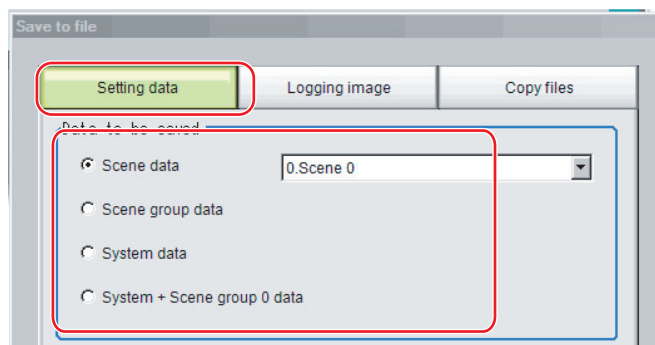

- 4 If you selected [Scene data], click the [▼] button to select the number of the scene to save.

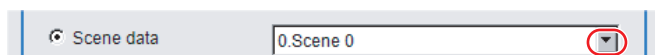



- 5** Specify the destination folder and file name.

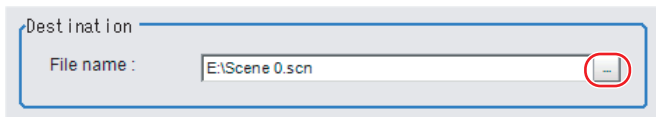

- 6** Click [OK].  
The dialog box showing transfer status is displayed, and the data is sent to the save destination.

## 9-4 Saving Logged Images in the Controller Memory (RAM) to a RAMDisk or an External Storage Device

Use the following procedure to save image data that was logged in the Controller memory (RAM) to the Controller RAM disk or an external storage device.

Refer to 9-1-1 *About Saving Areas* on page 9-3.

- 1** When saving data to external storage, insert the external storage device into the Sensor Controller.
- 2** In the Main Window, select [Save to file] from the [Function] menu.  
The [Save to file] dialog box is displayed.
- 3** Click [Logging image] and select the file to save.

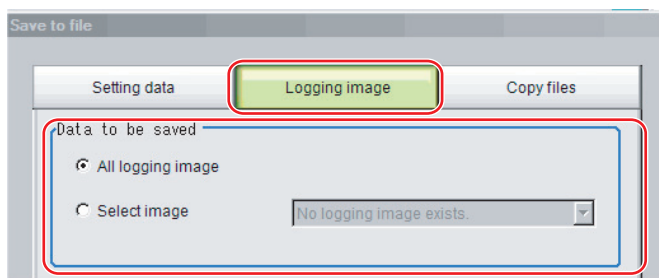

Parameter	Set value [Factory default]	Description
Data to be saved	[All logging image]	All logged images are saved.
	Select image	The selected logged images are saved. Click [▼] to select the image to save. When [Latest measurement] - [Logging image] is selected, the save file name will be LoggingImage000.ifz.

- 4** Specify the destination folder.

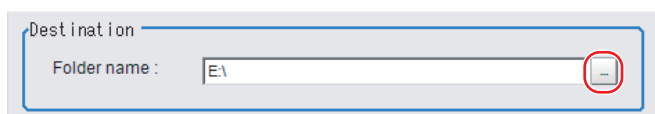

- 5** Click [OK].  
The dialog box showing transfer status is displayed, and the data is sent to the save destination.



### Additional Information

---

When you select [All logging image], the save file name is automatically specified as “Loggingimage000.ifz”.

The file names for the images through the image captured one trigger before the latest image are:

- Loggingimage000.ifz (latest image)
- Loggingimage001.ifz (image from one trigger ago)

The file names for the images through the image captured two triggers ago are:

- Loggingimage000.ifz (latest image)
- Loggingimage001.ifz (image from one trigger ago)
- Loggingimage002.ifz (image from two triggers ago)

The file names for the images through the image captured n triggers before the latest image are:

- Loggingimage000.ifz (latest image)
  - Loggingimage001.ifz (image from one trigger ago)
  - Loggingimage002.ifz (image from two triggers ago)
  - :
  - Loggingimage n.ifz (image from n triggers ago)
-

## 9-5 Copying or Moving Files between the Controller RAMDisk and an External Storage Device

You can copy or move files between the Controller RAMDisk and an external storage device.

Images and data saved on the RAMDisk are deleted if the power supply is turned OFF.

To keep these images and data, copy or move them to an external storage device.

The types of files that can be copied/moved are as follows:

- Setting data: System data, Scene data, and Scene group data
- Logged images
- Logged data: Measurement data

- 1** Insert an external storage device in the Controller.
- 2** In the Main Window, select [Save to file] from the [Function] menu.  
The [Save to file] dialog box is displayed.
- 3** Click [Copy files] and select the file or folder to copy or move.

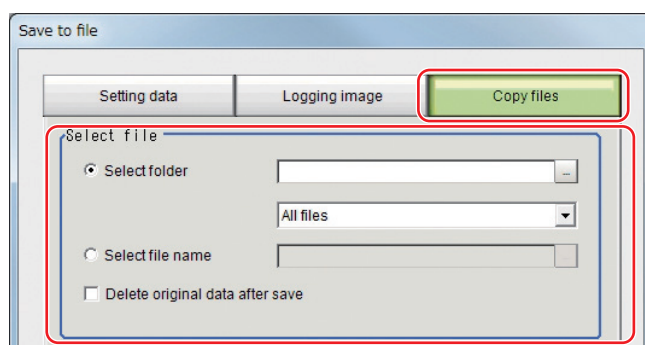

Parameter	Set value [Factory default]	Description
Select file	[Select folder]	Copies or moves more than one file in the folder. <ul style="list-style-type: none"> <li>• Click the [...] button and specify the source folder to copy or move a file from.</li> <li>• Click the [▼] button and specify the file type to select. Select [All files] to copy or move all files in the folder. Specify a file type to copy or move only files that are of the specified file type in the folder.</li> </ul>
	Select file name	Copies or moves the selected file. Click the [...] button and specify the file name.

- 4** To delete the copy source file after saving a copy to external storage, select [Delete original data after save].

Delete original data after save

- 5** Click [OK].  
The dialog box showing transfer status is displayed, and the data is sent to the save destination.

## 9-6 Loading Settings Data from the Controller RAMDisk or an External Storage Device to the Sensor Controller

Use the following procedure to load settings data that is saved in the Controller RAMDisk or an external storage device to the Sensor Controller. The scene name and scene group name that have been loaded are displayed in the Measurement Information Display Area.



### Important

- Always restart the Sensor Controller immediately after you load the settings data.
- If [Load from file] is performed for [System + scene group 0 data], the data being loaded will also be saved to the Controller's flash memory at the same time. While data is being loaded, do not restart, turn OFF the power supply, or remove the external memory device. Data will be corrupted and the system will not work properly at the next startup.
- If Non-procedure (Ethernet) or PLC Link (Ethernet) is used when Multi-line random-trigger mode is selected for Operation mode, change of [Input port No.] and [Output port No.] is required when loading the line 0 setting data to one of the line 1 to 7.
- If the software version to load is not older than the software version which is saved the setting data, it is possible not to be loaded the setting data file.

- 1 Perform either of the following in advance.
  - Send the setting data to the Controller's RAMDisk using the FTP.
  - Insert the external memory device that has the load data saved in it into the Controller.
- 2 In the Main Window, select [Load from file] from the [Function] menu.  
The [Load from file] dialog box is displayed.

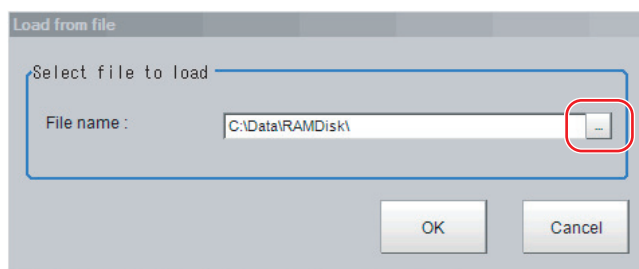

- 3 Select the file to load.
- 4 Click [OK].  
A dialog box that shows the progress of the transfer is displayed, and the data is transferred.  
The loaded settings are enabled after the Sensor Controller is restarted.
- 5 Select [System restart] from the [Function] menu.



### Additional Information

---

- You can change the Communicate Module after restarting. Restart it after loading, if you load the system data that is changed the Communicate Module. For applying the details of parameters after restarting, you should re-load the system data.  
Additionally, you can load only once because the bkd data write the backup data at once.
  - Layout settings will be applied when [Switch layout] is executed.  
Note that Layout change remains until [Switch layout] is executed when System data which changes the layout setting is loaded.
- 



### Important

---

- When the Scene data created via FZ series Sensor Controller, i.e. FZ5 series or FZ5-L series, [Camera Image Input] is automatically converted to [Camera Image Input FH].  
The automatically converted contents is the common items between [Camera Image Input] and [Camera Image Input FH]. The other settings is set to the default settings of the connected camera to the FH series Sensor Controller.
  - When FZ series Sensor Controller loads data created by FH series Sensor Controller, the data will not be automatically converted.
-

## 9-7 Backing up Sensor Controller Setting Data [Configuration Copy]

This function will back up the setting data of the Sensor Controller.

The capability to save/load a copy of the Sensor Controller settings as Sensor Controller project data facilitates copying desired settings to other Sensor Controllers.



### Important

- In the Non-stop Adjustment mode, Configuration Copy can be used only for line 0.
- In the Multi-line Random-trigger mode, Configuration Copy can be used only to line 0.
- Do not turn off the power supply and do not remove external storage devices while sensor controller project data is being saved or loaded. Doing so could damage the external storage device and corrupt the sensor controller project data.

### 9-7-1 Before Backing up

There are two types of settings data that can be backed up.

One is the setting data for the line, the other is the common setting data for the Sensor Controller.

The line for which setting data can be saved varies depending on the Operation mode. The common setting data for the Sensor Controller that can be saved does not depend on the Operation Mode.

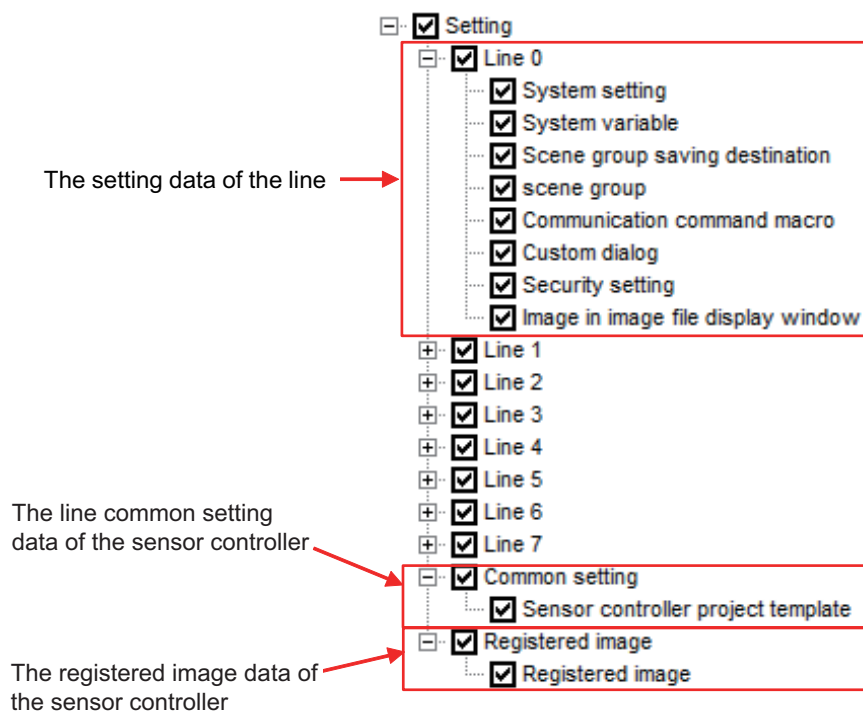

Operation Mode	Description
Standard	Line 0 settings and Common settings can be stored.
Double speed Multi-input	Settings for Line 1 to 7 cannot be stored.
Non-stop Adjustment	The data that are selected in the line 1 to 7 can not be stored.
Multi-line Random-trigger	The settings for any selected (checked) line plus Common settings can be stored.

## Setting data which can be backed up

The following is the detailed list of the setting data.

Type	Name	Description
Setting data of the line	System setting	System setting includes the following configuration. <ul style="list-style-type: none"> <li>The data of [System Settings] dialog box Refer to <i>4 Setting the Controller</i> on page 4-1.</li> <li>The layout information of the layout 0 to 8 Refer to <i>8-3 Arranging Windows [Layout Functions]</i> on page 8-14. (*1)</li> <li>The User Data Refer to <i>A-12 Sharing Data Within the Controller [User Data Tool]</i> on page A-37.</li> </ul>
	System variables	They are enabled within a defined line settings. Although they can be set and referenced across scenes and scene groups, they cannot be set and referenced in different lines with multiple line random modes. For details, refer to <i>5-5-1 Edit Flow Screen</i> on page 5-14 and <i>5-5-4 Using Variables</i> on page 5-43.
	Scene group saving destination	Setting contents of the Scene grope saving destination are the setting object. Refer to <i>7-5 Saving Scene Groups in External Storage [Scene Group Saving Destination Settings]</i> on page 7-10.
	Scene group	Scene grope saved to Sensor Controller or external memory <sup>(*2)</sup> are the setting object. All of the following settings include to Scene grope <ul style="list-style-type: none"> <li>Flow Settings of all scenes.</li> <li>Macro code of Scene Control Macro for all Scene.</li> <li>Scene Control Macro data of all Scenes. Refer to <i>Components of the Setting Screen of the Communication Command Macro Tool and How to Configure Settings</i> in the <i>Vision System FH/FZ5 Series Macro Customize Functions Programming Manual</i> (Cat. No. Z367)</li> <li>Image Container Window Settings of all scenes Refer to <i>8-3 Arranging Windows [Layout Functions]</i> on page 8-14.</li> <li>Image Window Settings of all scenes. Refer to <i>3-2-7 Changing the Image Mode and Other Display Contents</i> on page 3-24.</li> </ul>
	Communication command macro	The target data is the Communication Command Macro data. Refer to <i>Components of the Setting Screen of the Communication Command Macro Tool and How to Configure Settings</i> in the <i>Vision System FH/FZ5 Series Macro Customize Functions Programming Manual</i> (Cat. No. Z367).
	Custom dialog	The target data is all setting of the Custom dialog. Refer to <i>8-4 Creating a Custom Dialog Box [Custom Dialog Functions]</i> on page 8-67.
	Security setting	Security settings include the following configuration. <ul style="list-style-type: none"> <li>Account list</li> <li>Layout restrictions</li> <li>Operating restrictions</li> </ul> Refer to <i>10-3-4 Saving/Loading/Deleting the Security Settings</i> on page 10-36.



Type	Name	Description
Setting data of the line	Image in image file display window	Images displayed in image file display window. For details, refer to 8-3-12 <i>Image File Display Pane</i> on page 8-37.
The common setting data for the Sensor Controller	Sensor controller project template <sup>(*)3</sup>	The target template is the template that is stored by Configuration Copy. Refer to <i>Editing a Template</i> on page 9-22.
Registered image for the Sensor Controller	Registered image	The target image data is the image data that is stored in the Registered Image Manager. <sup>(*)4</sup> Refer to 6-7 <i>Managing Images used for Model Registration and Reference [Registered Image Manager]</i> on page 6-42.

- \*1. The layout information does not include the setting data of Image Container Windows. The setting data of Image Container Windows is included the scene data.
- \*2. FH/FHV/FZ5-800/1100/1200 series:  
The target data is available when External storage device is indicated in External storage device settings.  
FH5-L series/FZ5-600 series:  
The target data is the scene group 1 or later in the USBDisk folder.
- \*3. In Configuration Copy, you can register the selection status of configuration data as a Sensor controller's project template.
- \*4. FH/FHV/FZ5-800/1100/1200 series:  
The destination folder of the Registered image is "E:\RegisteredImage".  
FH5-L series/FZ5-600 series:  
The destination folder is " USBDisk:\RegisteredImage".



#### Additional Information

- When saving the system settings or scene group data individually, please refer to following.  
Refer to 9-3 *Saving Setting Data to the Controller RAMDisk or an External Storage Device* on page 9-8.
- When loading the system settings or scene group data individually, please refer to following.  
Refer to 9-6 *Loading Settings Data from the Controller RAMDisk or an External Storage Device to the Sensor Controller* on page 9-13.

## 9-7-2 Backing up Sensor Controller Settings

It's necessary to select the setting data of Sensor Controller and save the data to the External Storage Device to back up the data.

This chapter explains the procedures for launching the Configuration Copy function, selecting the settings data to save and selecting an External Storage Device for the save destination.



#### Important

- Before starting up Configuration Copy, click the [Data save] button. Only the data saved to the Controller can be backed up.
- For Multi-line random trigger mode, first, click [Data save] button at each lines. For each line, start up Configuration Copy.
- After loading a BKD file (System setting + Scene group 0 data), do not save the data. Launch the Configuration copy function after restarting Sensor Controller without saving.
- After loading the change of system setting or INI file (system set data), save to the Sensor Controller. restart the Sensor Controller, and then launch the Configuration copy function. Refer to 9-6 *Loading Settings Data from the Controller RAMDisk or an External Storage Device to the Sensor Controller* on page 9-13.

## Launching Configuration Copy

Necessary steps prior to launching Configuration Copy are explained here.

- 1** Connect the external storage device to the Sensor Controller.
- 2** From the [Tool] menu in the main window, select [Configuration Copy].
- 3** [Confirm] dialog box is displayed.

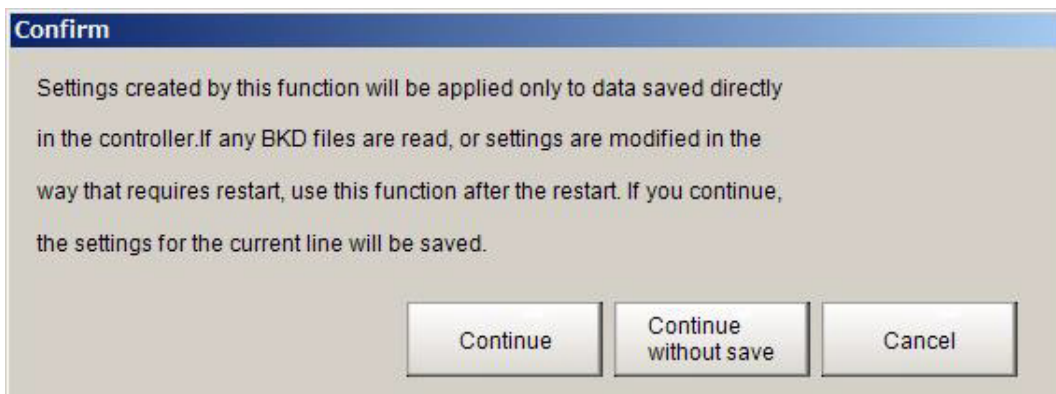

Click [Continue] button.

The Setting data for the line 0 and Common setting will be saved and the Configuration Copy function will be launched.

- In the case of multi-line random trigger mode,  
When not be saved the data of the line 0 to 7 for back up, please click [Cancel] button. If you click [Continue] button, the setting data of the line 0 to 7 can not be saved. Launch the Configuration Copy function after [Data Save] for all lines.



### Additional Information

If settings have been modified and you do not want to include the modifications in the sensor controller project, click the [Continue without save] button and the pre-edited settings will be saved to the project.

## Selecting the Settings to Back up

This section explains the procedures for selecting the settings to backup

- 1** Click [Save] tab.

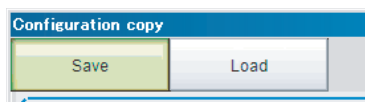

## 2 Save screen is displayed.

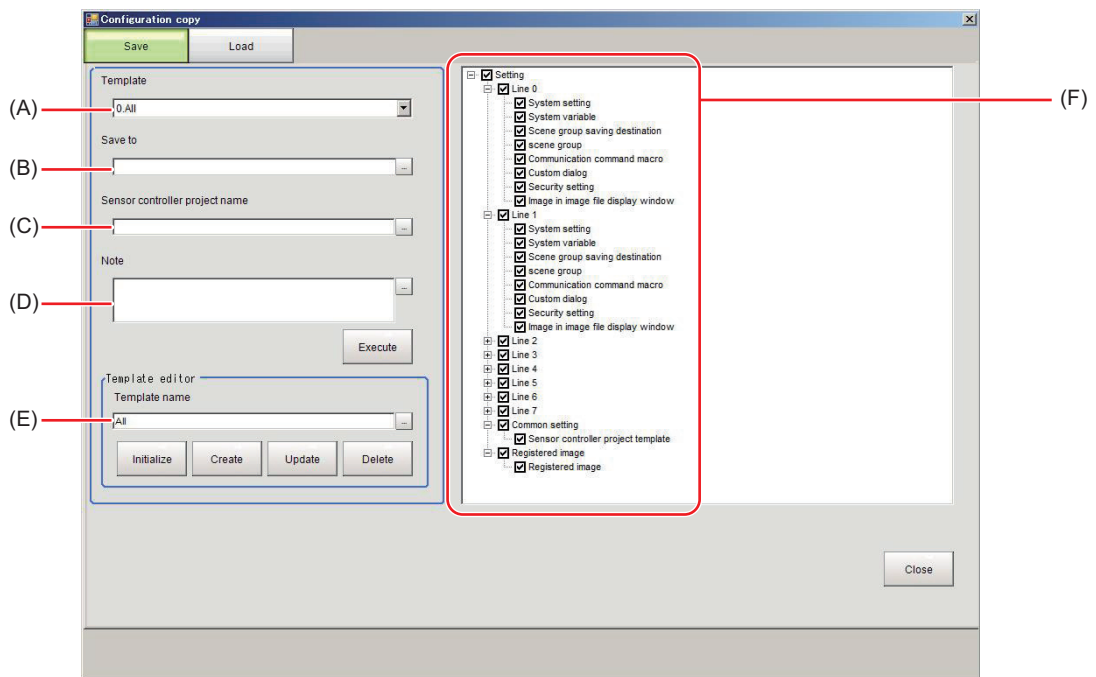

Symbol	Name	Set value [Factory default]	Description
(A)	Template	<ul style="list-style-type: none"> <li>• [0.All]</li> <li>• 1.Common setting</li> <li>• 2.Line0 + Common setting</li> <li>• 3.Line0</li> </ul>	By selecting a template, it is possible to choose the combination of setting data for backup. When selecting a template, a tree structure area will be displayed.
(B)	Save to	[Blank]	Specify the save destination folder. Please specify the folder of External memory device.
(C)	Sensor controller's project name	[Blank]	Specify the name of Sensor controller's project within a range of 1 to 256 characters. If a name is not entered here, the project is not saved.  The allowable number of characters is the same for double-byte and single-byte characters.  However, the following symbols can not be used in the name of Sensor controller's project. ¥ / : , ; * ? " < >
(D)	Note	[Blank]	Notes for such things as the content of Sensor controller's project and creation date can be entered here. [Note], You can use up to 256 characters. The allowable number of characters is the same for double-byte and single-byte characters. Newline character count as three characters.
(E)	Template editor	---	Edit the content of the template. Refer to <i>Editing a Template</i> on page 9-22.
(F)	Tree structure area	---	A list of settings is displayed. Check the settings data to back up.

**3** Select a template.

By selecting a template, it is possible to choose combination of the data for back up.

Templates are as follows.

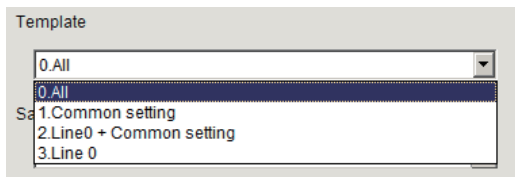

Template name	Description
All	Use in multi-line random trigger mode. All settings can be backed up in Configuration Copy. All setting data for the line 0 to 7 and all common setting data for the Sensor Controller will have their check box selected.
Common setting	All common setting data of the Sensor Controller will have their check box selected.
Line0 + Common setting	Use in Standard (operation mode), Double speed Multi-input mode and Non-stop Adjustment mode. All setting data for the line 0 and all common setting data of the Sensor Controller will have their check box selected.
Line0	Use in Standard (operation mode), Double speed Multi-input mode and Non-stop Adjustment mode. All setting data for line 0 will have their check box selected.



**Additional Information**

- It is possible to change the setting of a template.  
Refer to *Editing a Template* on page 9-22.
- Please refer to below for details of setting data.  
Refer to *Setting data which can be backed up* on page 9-16.

**4** Select the check box of the settings data to save.

Clear the check box for any settings you do not want to have saved.

(example)

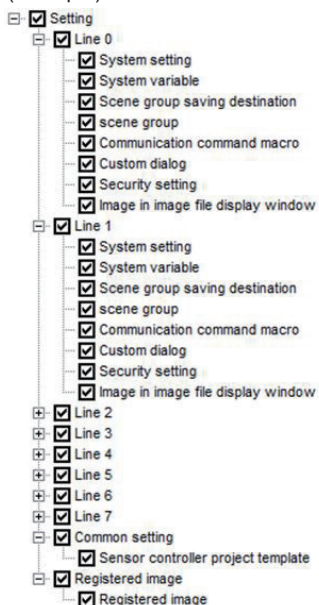

## Saving to an External Storage Device

This section explains the procedures for saving settings data to the External Storage Device.

- 1 Set [Save to], [Sensor controller's project name] and [Note].  
Creates the sensor controller project as the file in save destination.  
Saves the selected setting data to the folder of the sensor controller project.

- 2 Click [Execute] button.

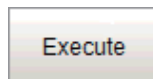

- 3 While saving the sensor controller's project, [Processing] dialog box is displayed.

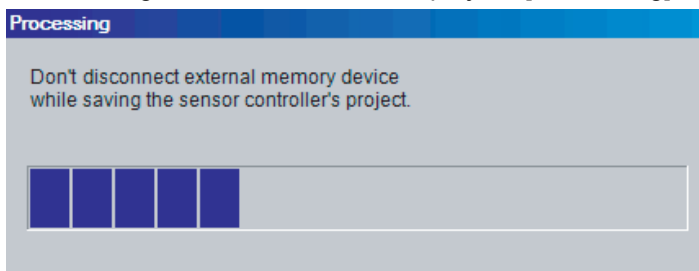

### Important

**While saving the sensor controller's project, do not turn off the power supply of the Sensor Controller, or disconnect the external storage device. Doing so could corrupt the external storage device, or corrupt the sensor controller project data.**

- 4 After saving the sensor controller's project, [Confirm] dialog box is displayed.  
After successfully saving in saving the Sensor Controller project, folder with project name specified when setting the save destination to the external storage device. Saves the selected setting data to the folder of the sensor controller project.

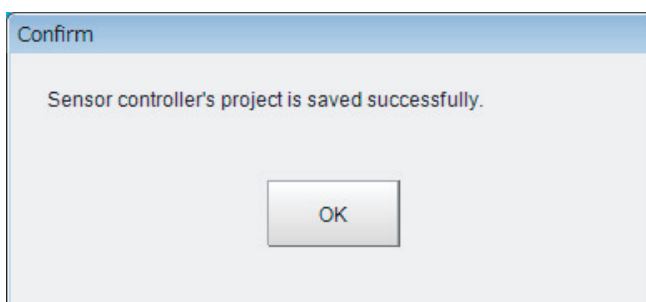

**Important**

Do not edit the file or folders which saved to sensor controller project.  
Doing so could cause the sensor controller to not start up normally when loading the project file.

**Editing a Template**

By editing a template before using it, it is possible to omit un-needed setting data.

- **Template editor screen**

The settings for [Template editor] are explained here.

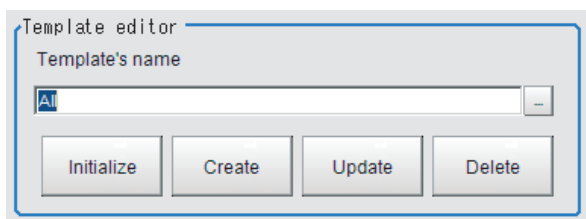

Setting item	Setting value [Factory default]	Description
Template's name	<ul style="list-style-type: none"> <li>• [All]</li> <li>• Common setting</li> <li>• Line 0 + Common setting</li> <li>• Line 0</li> </ul>	<p>A selected template is reflected by [Template's name].</p> <p>When creating a new template, you can specify the template's name using up to 256 characters.</p> <p>The allowable number of characters is the same for double-byte and single-byte characters.</p>

Button	Description
Initialize	<p>When initializing the setting of a template, click [Initialize] button.</p> <p>Available templates are [All], [Common setting], [Line 0 + Common setting] and [Line 0].</p> <p>The data edited the template is initialized and can not be returned to the edited data.</p> <p>Refer to <i>Initialize a template</i> on page 9-25.</p>
Create	<p>Create a new template. (*1)</p> <p>Input a template's name and select the setting data, and then click [Create] button.</p> <p>Refer to <i>Create a template</i> on page 9-23.</p>
Update	<p>Without changing the template's name, the selection of setting data is changed.</p> <p>Select the template and select the setting data, and then click [Update] button.</p> <p>Refer to <i>Updating a template</i> on page 9-24.</p>
Delete	<p>Delete an unnecessary template.</p> <p>Select the template and then click [Delete] button.</p> <p>Deleted template can not be returned to the original.</p> <p>Refer to <i>Deleting a template</i> on page 9-26.</p>

\*1. The number of template that can be registered is 1 to 256.

## ● Create a template

Describes the steps for creating a new template.

### 1 Select a template.

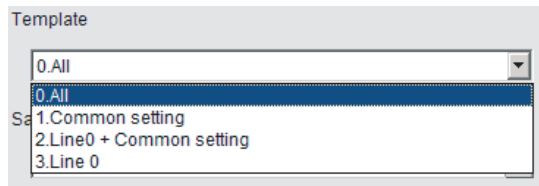

### 2 Select the check box of the target data for back up.

Clear the check box for settings you do not want to save.

(example)

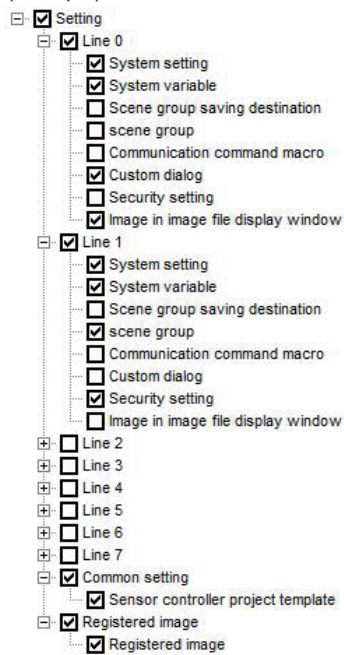

### 3 Enter the template's name.



### 4 Click [Create] button.

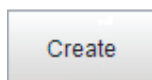

### 5 [Confirm] dialog box is displayed.

After confirming the setting data and template's name, click the [OK] button.

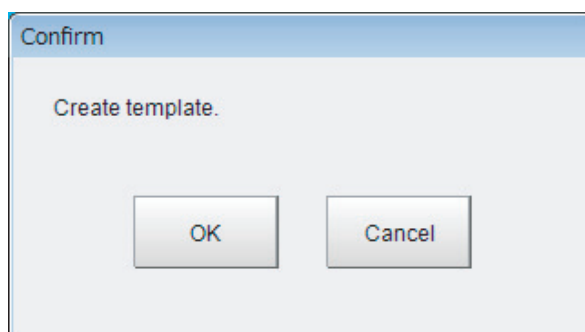

**6** A new template name will be created.

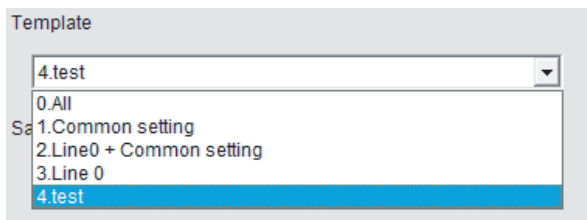

**Additional Information**

- A template number being attached to the head of a template is automatically assigned to a template in ascending order when creating. When a template is deleted, its assigned number will be re-assigned when creating a new template.
- Although it is possible to register multiple templates with the same name, it is recommended to use different names to avoid mistake to select.

**● Updating a template**

Describes the steps for creating a new template.

**1** Select the template to update.

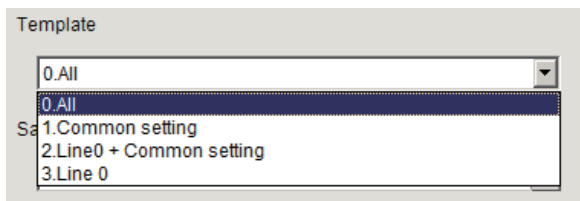

**2** Select the check box of the target data for back up.  
Clear the check box for settings you do not want to save.

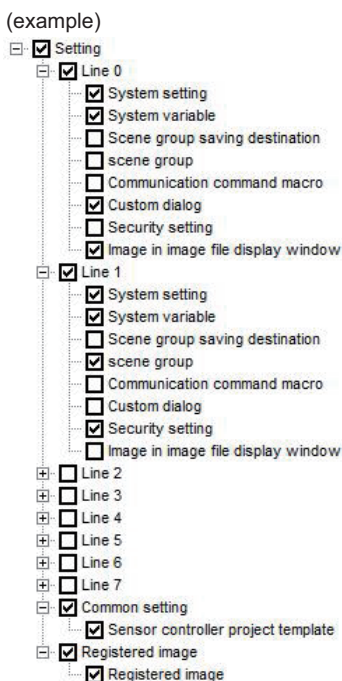

**3** Click [Update] button.

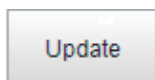



- 4** [Confirm] dialog box is displayed.  
After confirming the setting data, please click [OK] button.  
A template is updated.

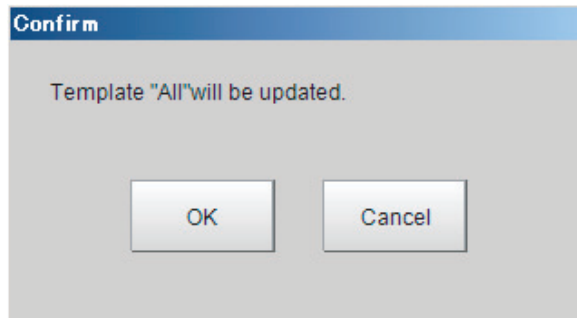

#### Additional Information

When [Update] button is clicked after the template name is changed, it's possible to change the template name.

### ● Initialize a template

Describes the steps for creating a new template.

- 1** Click [Initialize] button.

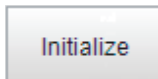

- 2** [Confirm] dialog box is displayed.  
Click [OK] button.

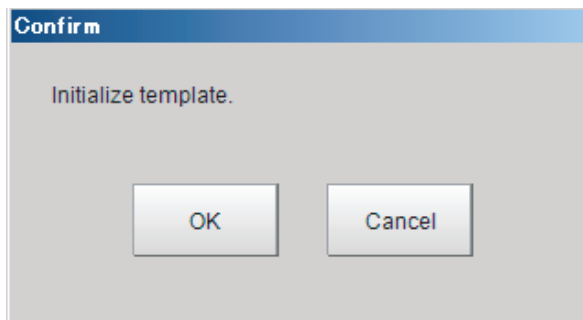

- 3** The template settings revert to the factory default settings.

### ● Deleting a template

Describes the steps for creating a new template.

- 1 Select the target template to delete.

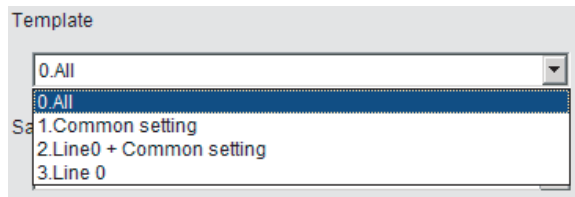

- 2 Click [Delete] button.

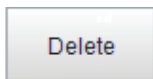

- 3 [Confirm] dialog box is displayed.  
After confirming, click [OK] button.

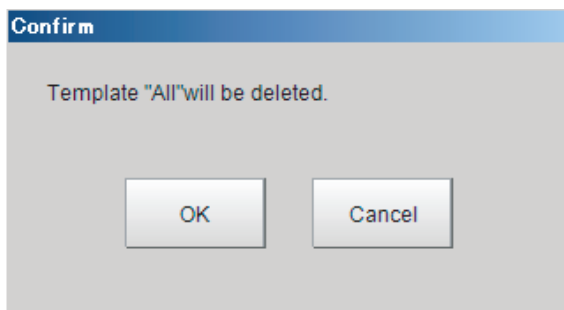

- 4 The template is deleted.

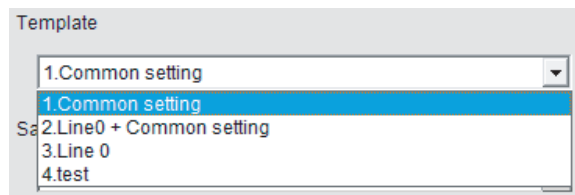

#### Additional Information

---

Even if a template is deleted, the template number isn't updated. When a template is deleted, and there is a space in the template number, the template number is assigned to an ascending order at the time of creation of a template and to fill a vacancy.

---

## 9-7-3 Restoring Saved Settings

Saved settings for a sensor controller can be restored, or copied.

This section explains the procedures for loading a sensor controller project with the Configuration copy function.



### Important

- Do not manually edit a file in a sensor controller project. Doing so will cause an error and the project will not be readable.
- Before loading a sensor controller's project, it is recommended to back up the setting of the Sensor Controller. If failure to load a sensor project occurs, the sensor controller does not return to its previous state.
- When connecting an external storage device to the sensor controller, make sure that it is the same drive name and same device as the sensor controller project was saved. If not, loading the sensor controller project fails.

**1** Connect the External Memory device to the Sensor Controller.

**2** From the [Tool] menu, select [Configuration Copy].

**3** [Confirm] dialog box is displayed.

After confirming, please click [Continue] button. [Configuration copy tool] starts.

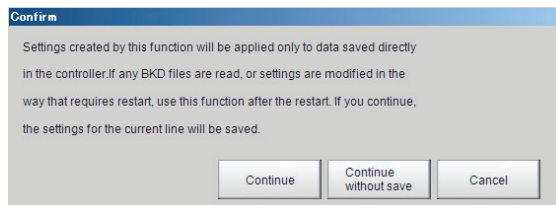

**4** Click [Load] tab.

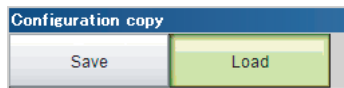

**5** Load screen is displayed.

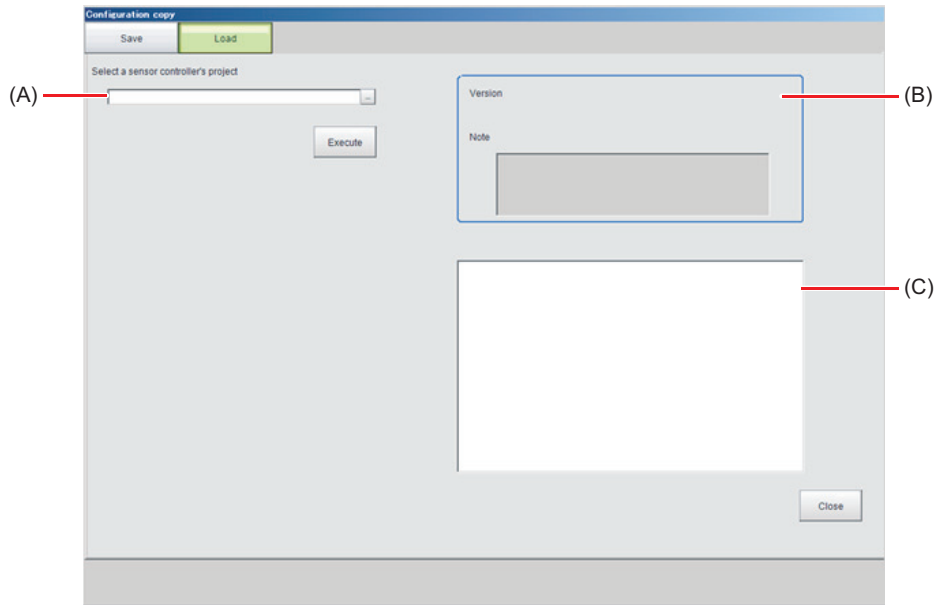

	Name	Set value [Factory default]	Description
A	Select a sensor controller's project	[Blank]	Select a sensor controller's project file to load to the Sensor Controller.
B	Information view	[Blank]	The information for the selected sensor controller's project is displayed. <ul style="list-style-type: none"> <li>• Version: The version of the sensor controller which saved sensor controller's project is displayed. Refer to 3-3 <i>Checking System Information</i> on page 3-27.</li> <li>• Description: The description of saved sensor controller's project is displayed.</li> </ul>
C	Tree structure area	---	A list of the setting of the sensor controller's project is displayed.

- 6** Select the sensor controller's project from [Select a sensor controller's project].  
 Select the Sensor Controller's project on the [Folder selecting] window with clicking [...] in [Select a sensor controller's project].  
 The version and note of the Sensor Controller of selected the sensor controller's project is displayed in the information view.  
 Selected Version information and Note are displayed in the information display label.

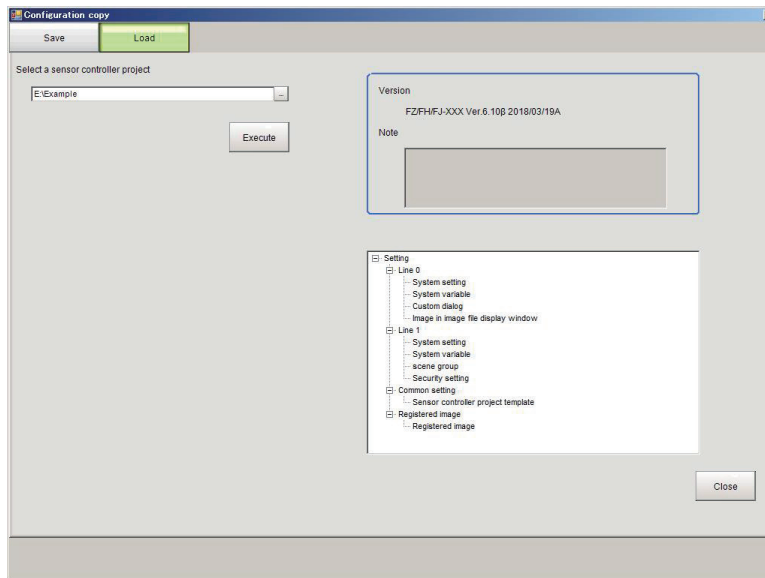

- 7** Click [Execute] button.

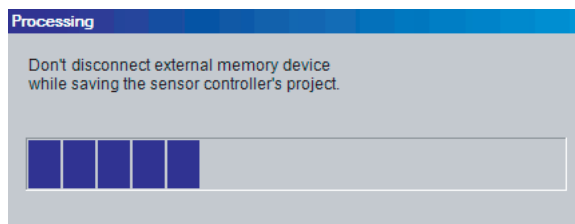

Starts to load the setting data including the selected sensor controller project in Step 6.

The following screen is displayed.

If an error occurs during this process, refer to below.  
 Refer to 9-7-4 *Troubleshooting* on page 9-30.



### Important

Do not turn off the power, or disconnect the external memory device during the loading of the sensor controller project. Doing so may cause damage to the external memory, or the sensor controller project.

- 8** The following confirmation dialog box is displayed when the loading is finished.  
 Restarting the Sensor Controller is required to apply the loaded settings

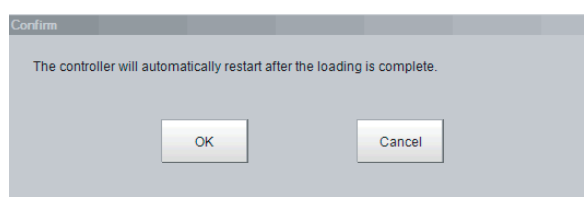

- 9 The following [Confirm] dialog is displayed. Click the [OK] button to restart the Sensor Controller.

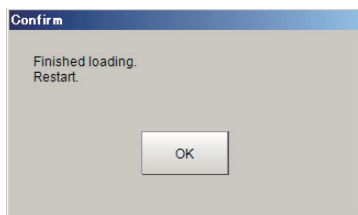

### 9-7-4 Troubleshooting

This section explains possible error messages that may be displayed while using Configuration Copy, as well as possible solutions.

● **Errors that may occur when loading.**

During the loading of a sensor controller's project, the following error message is displayed. (example) Loading of settings data file failed.

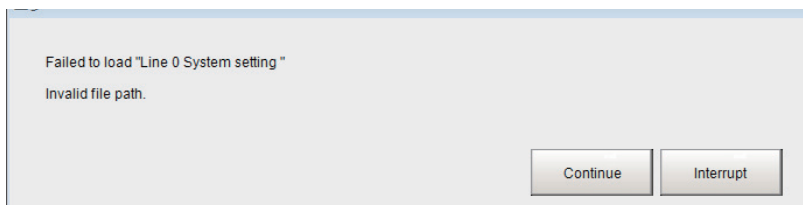

- To continue the loading of the Sensor Controller's project  
Click [Continue] button.  
Loading of the sensor controller will continue, however, the settings data that caused the error message to display will not be applied.
- To cancel the loading of the sensor controller's project  
Click [Interrupt] button.  
Loading of the sensor controller will stop. After stopping, you can refer to the troubleshooting list to find the possible cause and solution for the problem.  
After that, initialize the sensor controller, and then reload the sensor controller's project.

Troubleshooting list

Phenomenon	Cause	Action
An error message occurred because the Sensor Controller's project cannot be saved.	Save destination is not set.	Set the save destination.
	Name of the Sensor Controller's project is not entered.	Enter the Sensor Controller project name.
	An empty capacity of the external storage is insufficient.	<ul style="list-style-type: none"> <li>• Change to an external storage device with larger memory capacity.</li> <li>• Delete the unnecessary files.</li> </ul>

Phenomenon	Cause	Action
An error message occurred because loading of the Sensor Controller's project failed. "File writing failed."	Insufficient free memory in Sensor Controller	Resave to the Sensor Controller after increasing free memory space by deleting Scenes, or Processing units, adjusting the measurement region of Processing unit, or registered model size.
	External storage is not plugged in.	Plug in the external storage.
	Sensor Controller's project files is corrupted.	<ul style="list-style-type: none"> <li>Power was possibly turned off during last save operation.</li> <li>Insufficient memory can occur due to increased memory requirement for current Operation mode.</li> </ul>
	A Sensor Controller project saved by FH series/FZ5-800/1100/1200 series is loaded by FZ5-L series/FZ5-600 series.	Save destination of Scene group can differ if the created environment and loading environment are different. Set the save destination.
An error message occurred because loading of the Sensor Controller's project failed. "File destination does not exist."	External storage is not plugged in.	Plug in the external storage.
	Drive name of external storage differs from the Sensor Controller project.	Set the save destination.
Change screen of the save destination setting for Scene grope is displayed.	A Sensor Controller project saved by FH series/FZ5-800/1100/1200 series is loaded by FZ5-L series/FZ5-600 series.	Save destination of Scene grope can differ if the created environment and loading environment are different. Set the save destination.
	Model type is different from saved Sensor Controller and loading one.	Save destination of Scene grope can differ. Reset the save destination.
	Connected storage configuration differs.	

## 9-8 Copying Settings for Each Line in Multi-line Random-trigger Mode [Line Maintenance]

---

This tool can be used in Line 0 in Multi-line random-trigger mode to copy line settings for one line to other lines. It can also clear settings.

This function is only for Multi-line Random trigger mode.



### Important

---

- Launch the Line Maintenance tool from Line 0. It cannot be launched from other lines (1-7).
  - System setting data from line 0 can be copied to lines 1-7, but the opposite, copying System setting data from lines 1-7 to line 0 is not possible.
- 



### Additional Information

---

For copying, or clearing line-specific scene data, or scene group data, select Scene Maintenance from the Function menu.

Refer to *7-3 Editing Scenes [Scene Maintenance]* on page 7-6.

---



### 9-8-1 Before use of Line Maintenance

There are two types of settings data that can be configured with the Line Maintenance tool, Line-specific settings data and sensor controller settings common to all lines. Line-specific settings data can be copied and cleared. Sensor Controller settings common to all lines can be cleared.

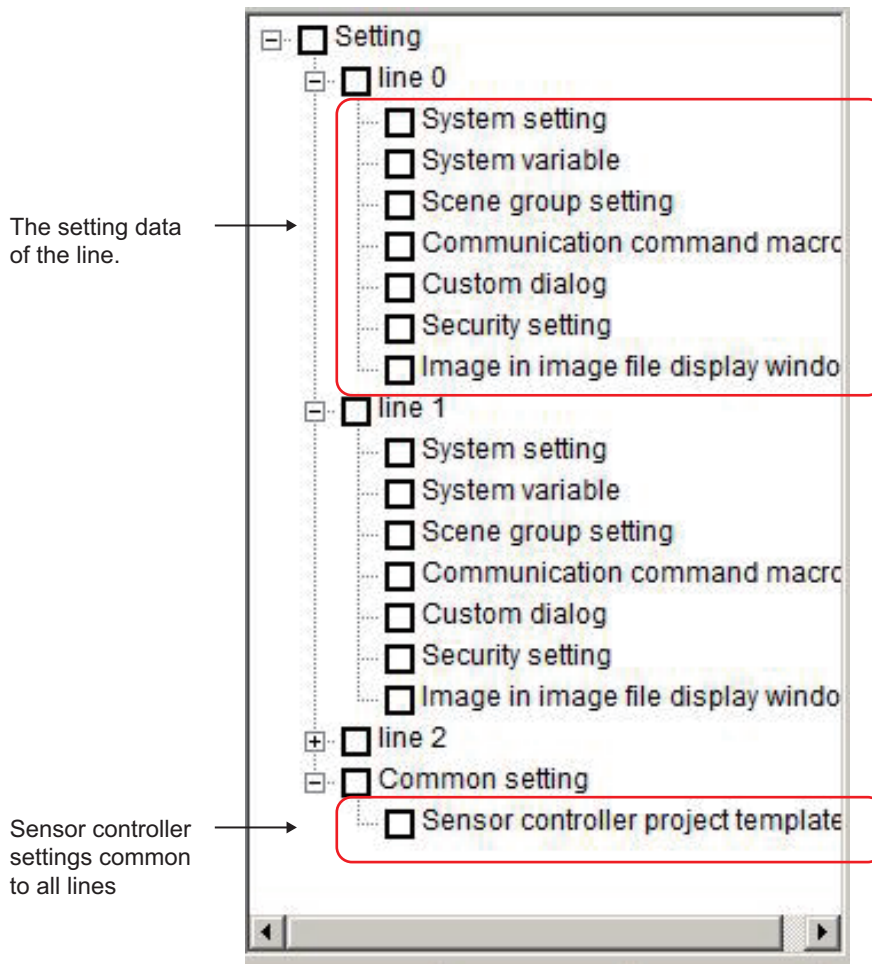

## Applicable Line Maintenance settings data

A detailed list of all settings data that can be copied, or cleared.

Type	Name	Definition
Line settings	System setting	System settings include the following. <ul style="list-style-type: none"> <li>• Menu contents of the System settings screen Refer to <i>Section 4 Setting the Controller</i> on page 4-1.</li> <li>• Layout information for layouts 0-8 Refer to <i>8-3 Arranging Windows [Layout Functions]</i> on page 8-14*<sup>1</sup>.</li> <li>• User Data Refer to <i>A-12 Sharing Data Within the Controller [User Data Tool]</i> on page A-37.</li> </ul>
	System variables	They are enabled within a defined line settings. Although they can be set and referenced across scenes and scene groups, they cannot be set and referenced in different lines with multiple line random modes. For details, refer to <i>5-5-1 Edit Flow Screen</i> on page 5-14 and <i>5-5-3 Editing Scenes</i> on page 5-34.
	Scene group setting	This setting is applied to the Scene group saved to the Sensor Controller or the external storage device.* <sup>2</sup> Scene group settings include the following. <ul style="list-style-type: none"> <li>• Flow Settings of all scenes.</li> <li>• Macro code of Scene Control Macro for all Scenes. Refer to <i>Components of the Setting Screen of the Scene Control Macro Tool and How to Configure Settings in the Vision System FH/FZ5 Series Macro Customize Functions Programming Manual</i> (Cat. No. Z367).</li> <li>• Image Container Window Settings of all scenes Refer to <i>8-3 Arranging Windows [Layout Functions]</i> on page 8-14.</li> <li>• Image Window Settings of all scenes. Refer to <i>3-2-7 Changing the Image Mode and Other Display Contents</i> on page 3-24.</li> </ul>
	Communication Command Macro	Applicable codes for Communication Command Macro. Refer to <i>Components of the Setting Screen of the Communication Command Macro Tool and How to Configure Settings in the Vision System FH/FZ5 Series Macro Customize Functions Programming Manual</i> (Cat. No. Z367).
	Custom dialog	Applicable to all Custom dialog settings Refer to <i>8-4 Creating a Custom Dialog Box [Custom Dialog Functions]</i> on page 8-67.
	Security Setting	The following is the applicable security settings. <ul style="list-style-type: none"> <li>• All accounts</li> <li>• Layout restrictions</li> <li>• Operation restrictions</li> </ul> Refer to <i>10-3-4 Saving/Loading/Deleting the Security Settings</i> on page 10-36.
	Image in image file display window	Images displayed in image file display window. For details, refer to <i>8-3-12 Image File Display Pane</i> on page 8-37.

Type	Name	Definition
Sensor Controller settings data	Sensor controller's project template	Applicable to templates created in the Configuration Copy tool. Refer to <i>Editing a Template</i> on page 9-22.

- \*1. Excludes settings for the image container window. Image container window settings are included in the scene.
- \*2. FH series/FZ5-800/1100/1200 series:  
The file will be the same as that specified in the settings menu of the Scene Group Save Destination for an external storage device.  
FZ5-L series/FZ5-600 series:  
Scene Group Save destination settings do not matter and it will be at least one Scene Group file in the USBDisk folder.

## Line Maintenance Screen Layout

A description of the Line Maintenance screen layout and settings.

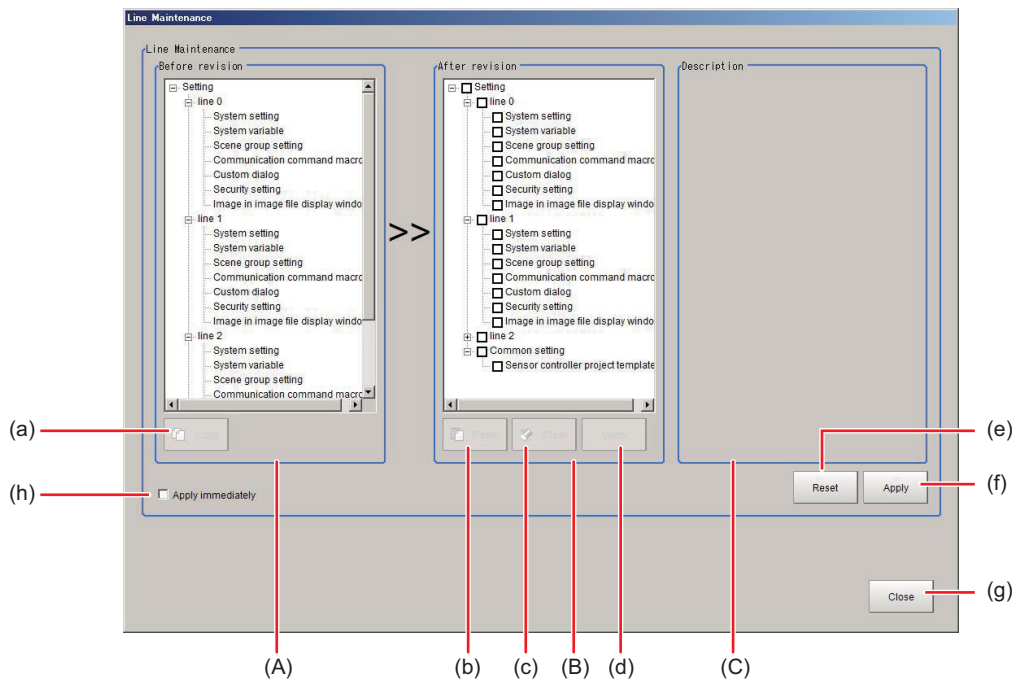

- (a) Before revision area  
The area for selecting setting data to copy. Display line settings data for Multi-line random-trigger mode.
- (b) After revision area  
Selection area for settings data to Paste/Clear. The line settings data for the lines set in Multi-line random-trigger mode will display.
- (c) Description area  
The area where a description of the settings data is displayed. Clicking on the settings in either the Before revision area, or the After revision area will display the settings data.
- (d) [Apply immediately]  
There are some functional limitations when [Apply immediately] is selected. The timing of when copied, or cleared settings data gets reflected in the sensor controller settings varies.  
Refer to 9-8-3 *Operating with Functional Limitations* on page 9-44.

## ● Button functions

An explanation of sensor controller button functions.

Symbol	Buttons	Definition
(a)	Copy	The selected settings data in the Before revision area will be copied.
(b)	Paste <sup>(*1)</sup>	The settings data copied from the Before revision area will overwrite the settings data in the After revision area.
(c)	Clear <sup>(*1)</sup>	The selected settings data in the After revision area will be re-initialized, or deleted.
(d)	Undo <sup>(*2)</sup>	All operations of [Paste] and [Clear] in After revision area are canceled.
(e)	Reset <sup>(*2)</sup>	All operations executed in both the Before revision and After revision areas will be erased. The settings will be restored to the time when the Line maintenance tool was launched, or to the same as when the last Apply immediately operation was done.
(f)	Apply immediately <sup>(*2)</sup>	Copied, or cleared settings data will be applied immediately to the sensor controller. Will not revert to the system state prior to applying the setting change.
(g)	Close	This will close the Line Maintenance window. After the window is closed the sensor controller will automatically restart and the changes made with the Line Maintenance tool will be reflected.

\*1. If the [Apply immediately] box is not checked, the changes will not be reflected in the sensor controller settings until the [Apply] button is clicked.

If the [Apply immediately] box is checked, changes will be reflected in the sensor controller settings immediately after [Copy], or [Clear] are clicked.

\*2. If [Apply immediately] is checked, it can not be clicked.

## 9-8-2 Line Maintenance tool operations

Copies settings being used for one line to other lines. Also can clear settings for multiple lines. This explains the steps for using the Line Maintenance tool, from launching the tool to applying the results of Copy, or Clear operations to the sensor controller.

### Launching the Line Maintenance tool

This explains the steps for launching the Line Maintenance tool.

**1** In the [Tool] menu, select [Line Maintenance].

**2** The Confirm screen is displayed.

Click [Continue].

- The current settings for Line 0 and common sensor controller settings will be saved to Sensor Controller memory and then the Line Maintenance tool will launch.
- If the applicable settings data for Lines 0-7 has already been saved to Sensor Controller memory, select [Continue without save]. The Line Maintenance tool will be launched.
- For Lines 0-7, if any BKD files are read, or setting modifications that require a restart are made, the line settings data selected for Copy will not be saved in sensor controller memory. In that case, you should select [Cancel] to close the tool and re-launch the Line Maintenance tool after using [Data save] in the Function menu.  
Refer to the information in IMPORTANT below for the steps to take after closing the tool.

- Do the following immediately after loading the BKD data.
  1. Restart the Sensor Controller without performing [Data save].
  2. Launch the Line Maintenance.
- Do the following immediately after changing [System setting].
  1. Click [Data save] each Lines.
  2. Restart the Sensor Controller.
  3. Launch the Line Maintenance.

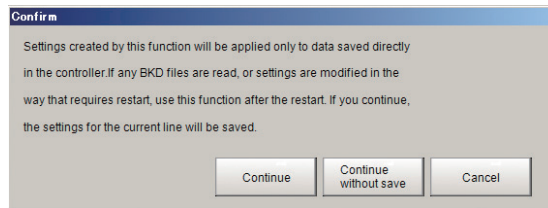

### Important

- Use [Data save] for each line prior to launching Line Maintenance tool. Settings data for lines which have not already had [Data save] performed can not be copied. The settings data for line 1-7 will not be saved to sensor controller memory if [Continue] is selected.
- After loading a BKD file (System setting + Scene group 0 data), do not save the data. Launch the Configuration copy function after restarting Sensor Controller without saving.
- After loading the change of system setting or INI file (system set data), save to the Sensor Controller. restart the Sensor Controller, and then launch the Configuration copy function. Refer to *9-6 Loading Settings Data from the Controller RAMDisk or an External Storage Device to the Sensor Controller* on page 9-13.



### Additional Information

If you do not want to copy settings that have been modified, select [Continue without save]. The pre-modified settings data will be copied.

- 3** If there is insufficient sensor controller memory, the Caution screen will display. If there is enough free memory, this screen will not display and you can proceed to Step 4. Select [Cancel] and close the tool. Launch the Line Maintenance tool after connecting an external memory device (2 GB, or higher recommended).

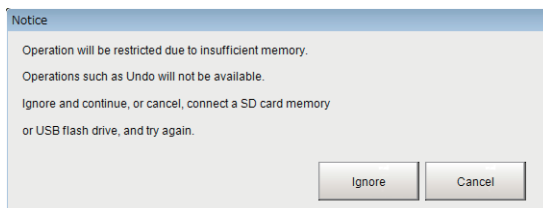

### Important

- When copying, or clearing settings data that requires higher memory capacity, some functions may be limited depending on the available sensor controller memory. It is recommended that the sensor controller be connected to an external storage device prior to launching the tool. (2 GB, or higher recommended)
- Do not disconnect the external storage device while using the Line Maintenance tool. Doing so could corrupt the external storage device, or cause the sensor controller to not operate normally.

If the [Ignore] button is selected, the Line Maintenance tool will be launched with the [Apply immediately] check box checked. this will cause some function limitations. Be careful when performing Clear, or Paste operations, as they will be applied immediately.

Refer to 9-8-3 *Operating with Functional Limitations* on page 9-44.

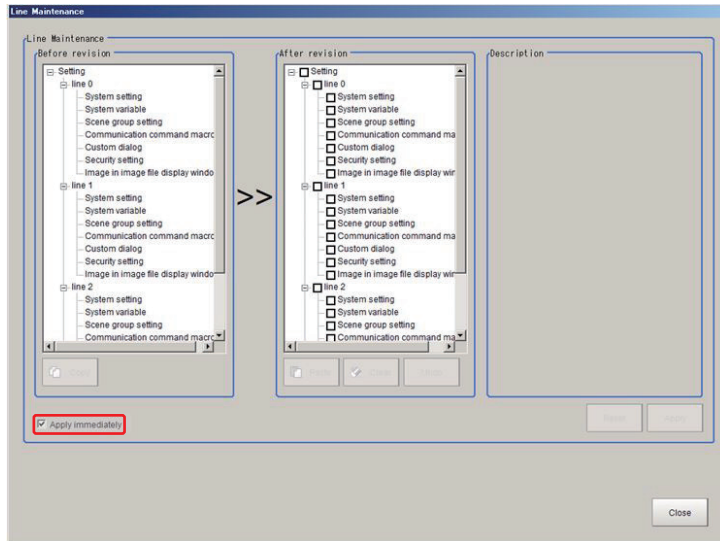

#### 4 Launch the Line Maintenance tool.

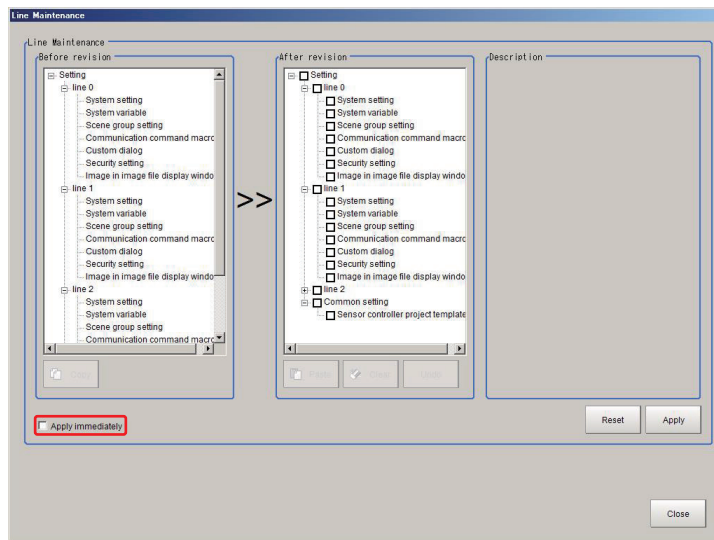

### Copy Setting data

This describes the steps for copying settings data. Settings data can be copied from one line and pasted in to another line.

#### 1 Select the setting data to copy in the Before revision area.

A description of the selected setting data will be displayed in the Description area.

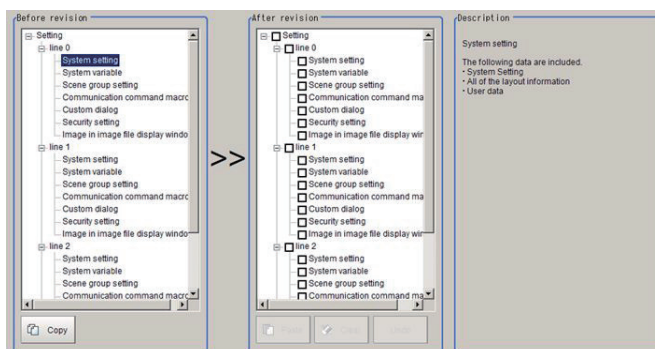

#### 2 Select [Copy].

[Copy] will be appended to all the selected setting data. The font color will change to blue.

If a mistake is made in the setting copy selection, re-select the setting data to copy and click [Copy].

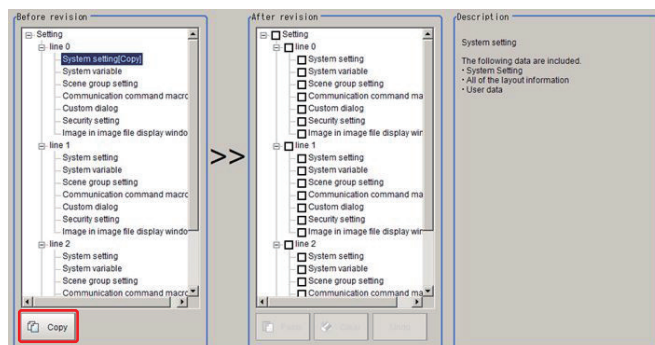

**3** In the After revision area, the setting data to be pasted will have its check box checked. In the following situations, the [Paste] button will be grayed out and a paste operation will not be possible. Verify the setting data in the After revision area.

- If the setting data for the same line as the copy setting data is checked.
- If the checked setting data differs from the setting data selected for copy.

The check boxes for the selected setting data in the After revision area will be cleared.

Refer to *Clearing setting data* on page 9-41.

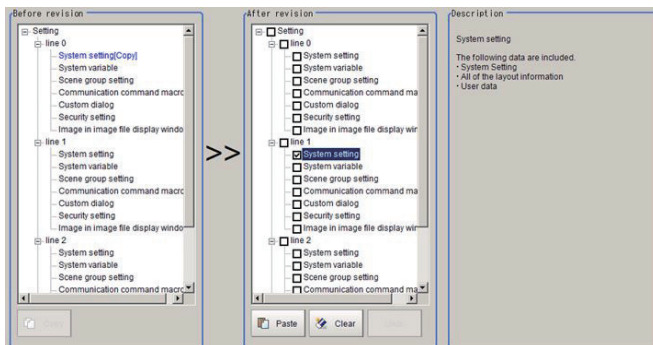

**4** Click [Paste].

The font color of the checked setting data will change to blue.

If the paste operation was done by mistake, click [Undo].

The setting data will revert to the status described in Step 3.

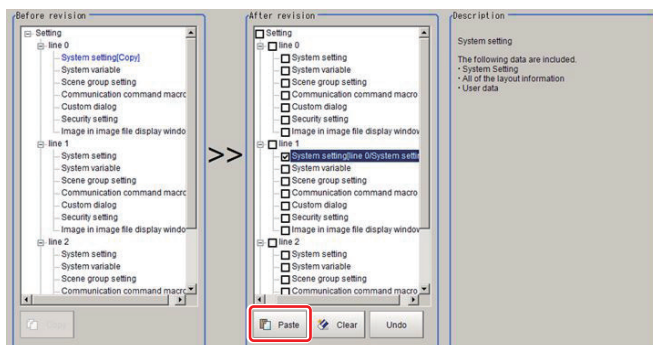

**5** To copy other setting data, repeat Step 1-4.



**Additional Information**

If there is insufficient memory in the sensor controller, the tool will be launched with [Apply immediately] checked.

Refer to *Launching the Line Maintenance tool* on page 9-36.



## Clearing setting data

This describes the steps for clearing setting data. All types of setting data can be cleared.

- 1 In the Line Maintenance tool, select the setting data in the After revision area.  
Multiple setting data can be selected.

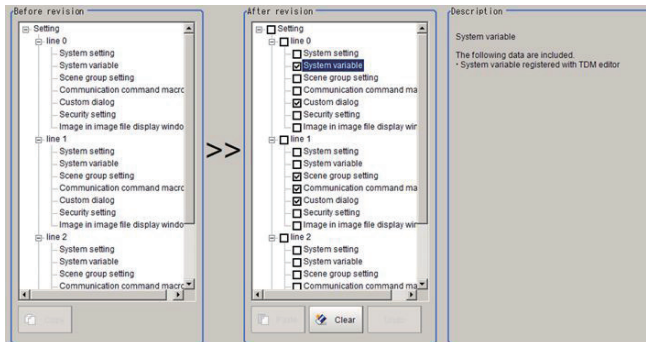

- 2 After selecting the settings, click the [Clear] button.

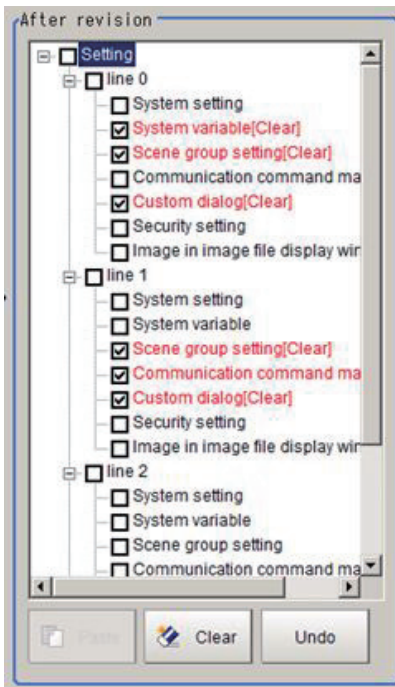

The font color of the setting data that will be cleared will change to red.

If setting data was cleared by mistake, click the [Undo] button. The setting data will revert to the status described in Step 1.

## Applying Copy/Clear Operations

This explains the steps for applying Copy/Clear operations on setting data to the sensor controller.

- 1 After a Copy/Clear operation on all setting data is complete, click the [Apply] button.

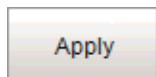

- 2 The following Confirm screen is displayed.

After confirming the After revision setting data is correct, click the [OK] button.

The setting data selected for Copy/Clear will be applied to the sensor controller. The applied settings can not revert to the previous state.

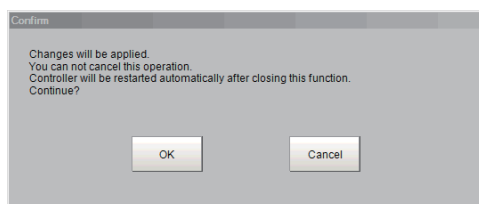

### Important

- Setting data is being applied. Do not turn off power. Doing so may cause the sensor controller not to operate properly.
- Do not disconnect the external storage device while using the Line Maintenance tool. Doing so could corrupt the data in the external storage device, or cause the sensor controller not to operate properly.

- 3 Click [Close].

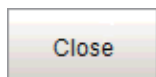

- 4 The following Confirm screen will display.

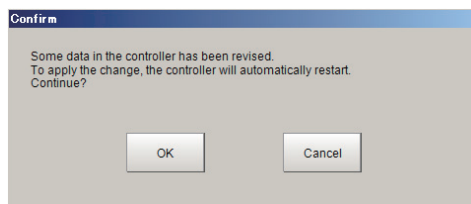

Click [OK]. The sensor controller will automatically restart.

- If, after a Copy/Clear operation is done and [Apply] is not selected, the following dialogue will be displayed when closing the tool.

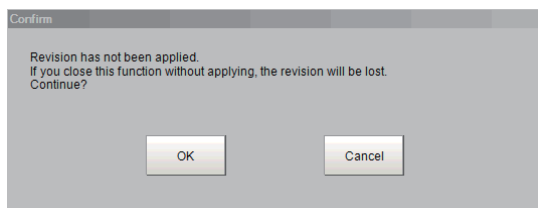

- If the setting data selected for Copy/Clear has not been applied, click the [OK] button. The sensor controller will automatically restart.
- If the setting data selected for Copy/Clear has been applied, click the [Cancel] button. Return to Step 1 and click the [Apply] button.

**Important**

---

**When copying system settings, verify the Communication settings for each line after restarting the sensor controller. Depending on the Communication settings selected, if Lines 0-7 have the same settings, the sensor controller may not be able to communicate with other devices.**

---

### 9-8-3 Operating with Functional Limitations

There are some functional limitations for the Line Maintenance tool when operating with [Apply immediately] checked. This is an explanation of the steps for operating the Line Maintenance tool with functional limitations.

#### Steps for Operating with Functional Limitations

This describes the steps for operating with [Apply immediately] checked.



#### Additional Information

If there is insufficient memory in the sensor controller, the tool will be launched with [Apply immediately] checked.

Refer to *Launching the Line Maintenance tool* on page 9-36.

- 1 With [Apply immediately] checked.

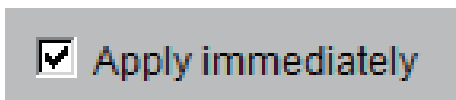

- 2 The following Confirm dialogue screen will display.

After verifying the setting data in the After revision area is correct, click the [OK] button.

Prior to checking the check box for [Apply immediately], the setting data is applied to the sensor controller immediately by the Copy/Clear operation.

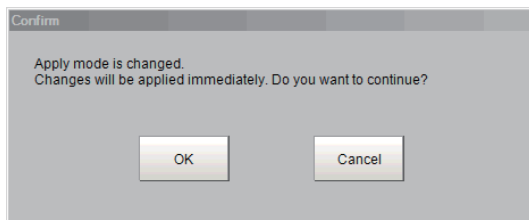

- 3 The [Undo], [Reset] and [Apply] buttons will be grayed out.

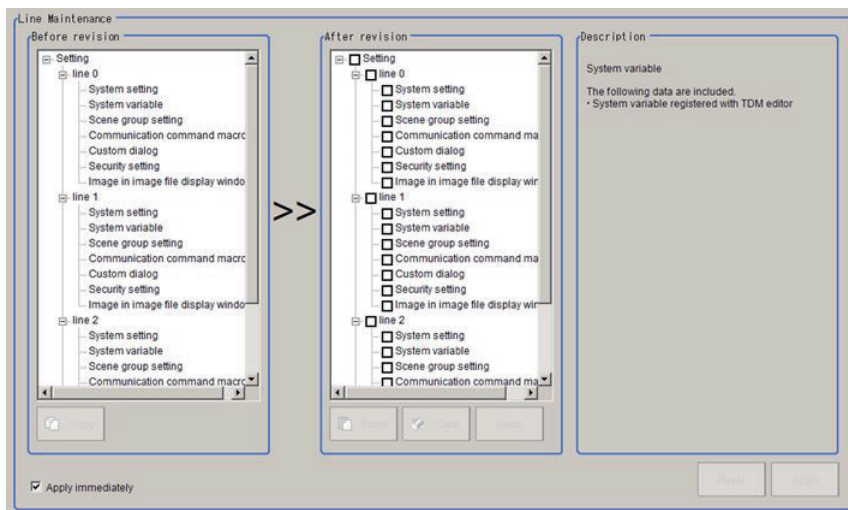

## Using Copy with Functional Limitations

This explains the steps for copying setting data when [Apply immediately] is checked.

- 1 Click on the setting data in the Before revision area you want to copy.

In the Description area, a description of the selected settings will be displayed.

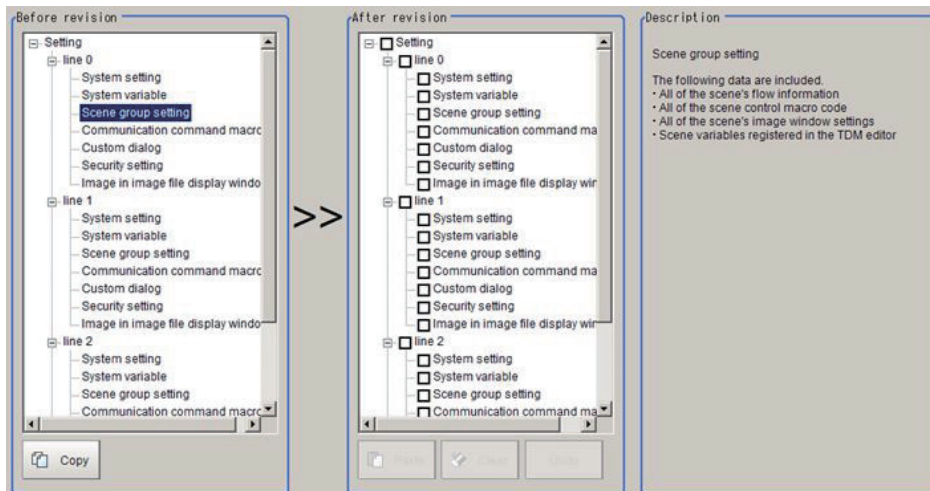

- 2 Click [Copy]

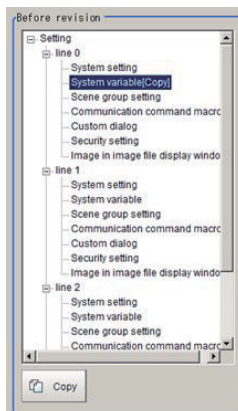

- 3 In the After revision area check the settings that will be copied.

The [Paste] button will be grayed out in the following cases.

- If the same line as that selected for setting copy is checked.
- If the setting data type differs from that which is checked for Copy operation.

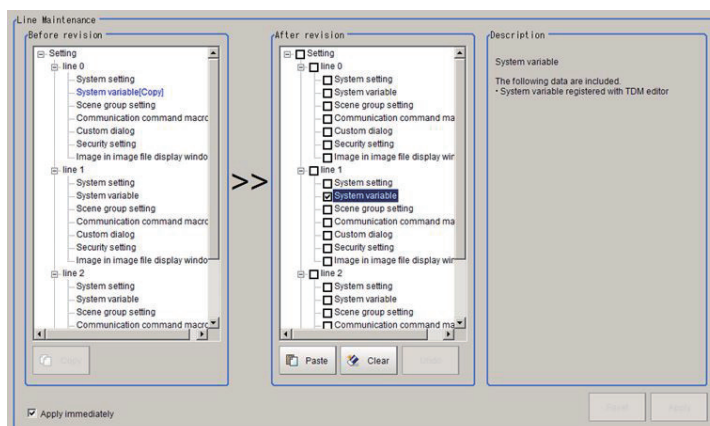

**4** Click the [Paste] button.

**5** The Confirm dialogue screen is displayed.

After verifying the setting data in the After revision area is correct, click the [Yes] button.

The selected setting data will be copied. Once the [Yes] button is clicked, the applied changes cannot be undone.

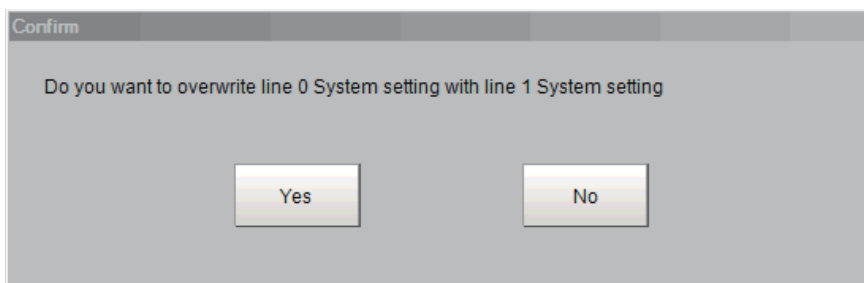

## Using Clear with Functional Limitations

This explains the steps for clearing setting data when [Apply immediately] is checked.

**1** Select the setting data to clear in the After revision area. Multiple setting data can be selected.

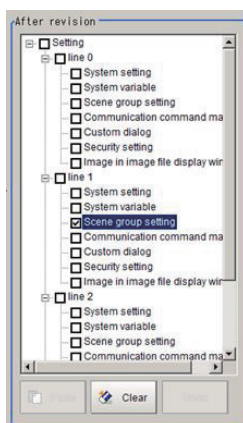

**2** The following Confirm dialogue screen is displayed.

After verifying the selected setting data in the After revision area is correct, click the [OK] button.

The selected setting data will be cleared. Once the [OK] button is clicked, the applied changes cannot be undone.

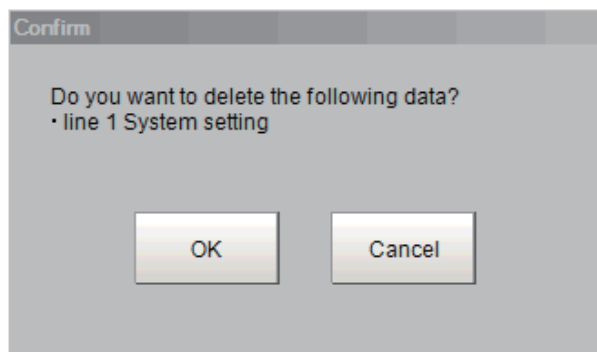

## Applying Copy/Clear changes with Functional Limitations

After the Line Maintenance tool is closed, the sensor controller will restart and the setting changes will be applied. This will describe the steps for closing the Line Maintenance tool.

- 1 Click [Close].

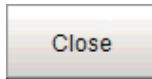

- 2 The following Confirm dialogue screen will display.

After verifying that the copied/cleared setting data is correct, click the [OK] button. The sensor controller will automatically restart.

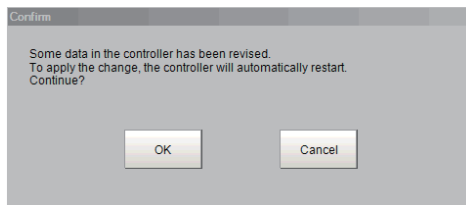

### Important

- When copying system settings, verify the Communication settings for each line after restarting the sensor controller.
- Depending on the Communication settings selected, if lines 0-7 have the same settings, the sensor controller may not be able to communicate with other devices.

## 9-8-4 Troubleshooting

A list of some common errors that may occur when using the Line Maintenance tool.

Problem	Cause	Action
An error message displays after clicking the [Apply] button.	The external storage device is not connected.	<ul style="list-style-type: none"> <li>• Connect an external storage device</li> <li>• Use the Copy/Clear function after checking [Apply immediately]</li> </ul>
Failed to apply changes. Failed to access file due to insufficient memory.	There is insufficient free memory available in the external storage device.	<ul style="list-style-type: none"> <li>• Re-connect an external storage device with more memory capacity.</li> <li>• Delete un-needed files in the external storage device to free up space.</li> <li>• Disconnect the external storage device and use the Copy/Clear function after checking [Apply immediately].</li> </ul>

## 9-9 Saving Image Files to a RAMDisk or an External Storage Device [Image File Save]

This section describes how to save logged images and image files that are saved in the Controller to a RAM disk or external memory device in the Controller. The storage format (bitmap or Jpeg) can be specified when the images are saved.



### Important

During saving, do not restart, turn OFF the power supply, or remove the external storage device. The data may be corrupted.

### Saving Logging Images

- 1 When saving data to external memory, insert an external storage device into the Sensor Controller.
- 2 In the Main Window, select [Image file save] from the [Tool] menu.  
The [Image file save] dialog box is displayed.
- 3 Click [Logging image] and select the logged image to save.

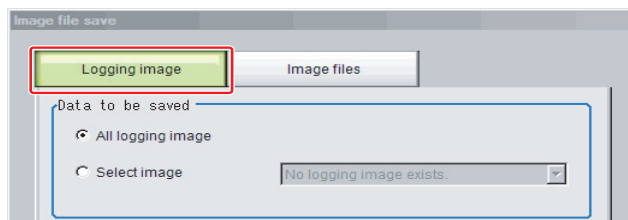

Setting item	Setting value [Factory default]	Description
Data to be saved	[All logging image]	All logged images are saved.
	Select image	The selected logged images are saved. Click [▼] to select the image to save. When [Latest measurement] - [logging image] is selected, the save file name will be LoggingImage000.ifz.

- 4 Specify the destination folder name and file type.

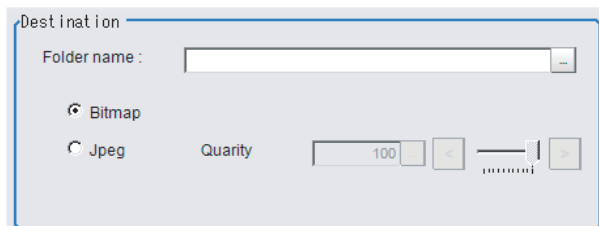

Setting item	Setting value [Factory default]	Description
Folder name	---	Specify the destination folder name.
Format	<ul style="list-style-type: none"> <li>• [Bitmap]</li> <li>• Jpeg</li> </ul>	Select the image format in which to save the image.



Setting item	Setting value [Factory default]	Description
Quality	0 to 100 [100]	Specify the quality of the Jpeg image to save

### 5 Click [OK].

The image is logged in the selected destination. If a file with the same name already exists in the destination folder, the newly saved file overwrites the old one.

## Saving Image Files

- 1 When saving data to external storage, insert an external storage device into the Sensor Controller.
- 2 In the Main Window, select [Image file save] from the [Tool] menu.  
The [Image file save] dialog box is displayed.
- 3 Click the [Image files] tab to select the image files to save.

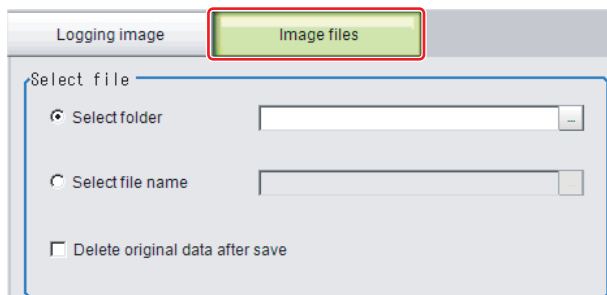

Setting item	Setting value [Factory default]	Description
Select file	[Select folder]	Saves multiple files in a folder. Click the [...] button and specify the source folder to copy or move.
	Select file name	Saves the selected image file Click the [...] button and specify the file name.

- 4 To delete the source file after saving a copy to external storage, select [Delete original data after save].

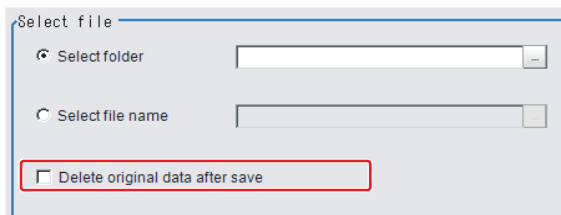

- 5 Specify the destination folder name and file type.

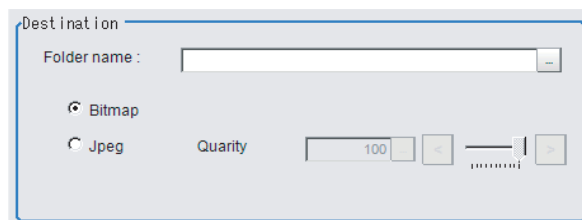

Setting item	Setting value [Factory default]	Description
Folder name	---	Specify the destination folder name.

Setting item	Setting value [Factory default]	Description
Format	<ul style="list-style-type: none"> <li>• [Bitmap]</li> <li>• Jpeg</li> </ul>	Select the image format in which to save the image.
Quality	0 to 100 [100]	Specify the quality of the Jpeg image to save

## 6 Click [OK].

The image is logged in the selected destination. If a file with the same name already exists in the destination folder, the newly saved file overwrites the old one.



### Additional Information

---

**The save file name is the original file name and the extension.**

---

## 9-10 Outputting a list of Scene Data Setting Values [Setting Values Download/Upload Tools]

In order to generating a list of setting values of scene data, use the "Settings download and upload tools".

With using the download function, setting values of the specified scene data can be downloaded as a CSV file format. By opening the CSV file with a editor, differences in setting values of multi scene data can be easily identified. (Only data with "Set/Get" attribute can be downloaded.)

With using the upload function, a CSV file whose setting values have already been identified can be uploaded.

### 9-10-1 Downloading Setting Values

- 1 Switch to a scene containing the setting values to download.
- 2 When saving data to external storage, insert an external storage device into the Sensor Controller.
- 3 In the adjustment window (layout 0), select [Settings download and upload tools] from the [Tool] menu.
- 4 Click [Download] and select the scene with the set values to download.

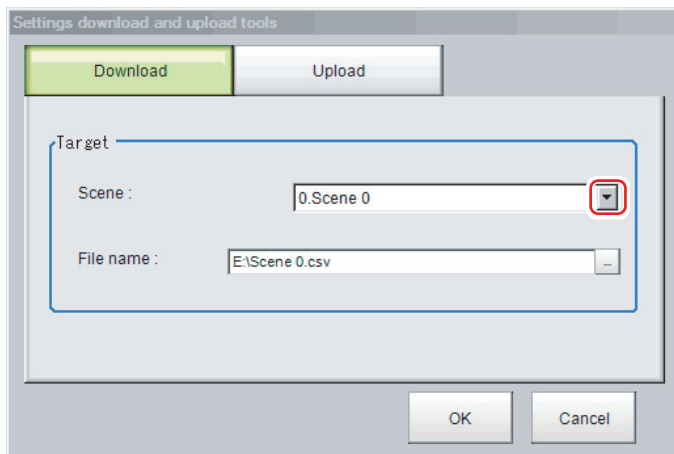

- 5 Specify the save destination folder and file name, and click [OK].

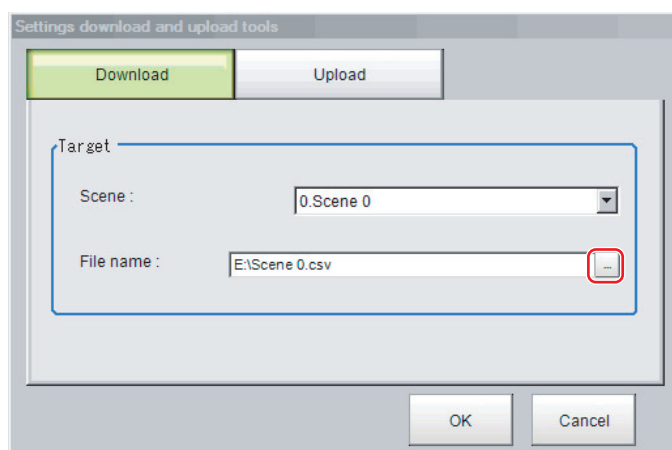

**6** Click [OK].

The data will be saved to the save destination.

**9-10-2 About Downloaded CSV Files**

The character code of the downloaded CSV file is Unicode (UTF-8).

You can open this file with the Notepad in Windows. When using another editor to open the file, set the character code to Unicode (UTF-8).

The CSV file format is as follows:

---

SceneTitle, Scene title name, Author, Note

---

#Processing item number in the flow, Processing item identifier, Processing unit title identifier, data title, data

---

Double-byte characters are enclosed in the double quotation marks ("").

Refer to the individual processing items and the external reference tables in the *Vision System FH/FHV/FZ5 Series Processing Item Function Reference Manual* (Cat. No. Z341) for the parameters for all data. Only data with "Set/Get" attribute can be downloaded.

Output Example of CSV File:

SceneTitle	Scene 0	
#0	Camera image	Camera Image Input
#1	Search	Search
outputCoordinate	Output coordinates	0
calibration	Calibration	0
overallJudge	Reflect to overall judgement	0
searchMode	Search mode	0
rotation	With/without rotation	0
endAngle	Upper limit of the rotation angle	180
startAngle	Lower limit of the rotation angle	-180
angleSkip	Skipping angle	5
smartMode	Smart mode	1
stability	Stab.(CR)	12
accuracy	Prec.	2
searchSpeed	Stab.(PT)	3
referencePosX	Reference X	0
referencePosY	Reference Y	0
detectionPosX	Detection point X	0
detectionPosY	Detection point Y	0
subPixel	Sub-pixel	0
candidateLevel	Candidate Point Level	70
upperX	Upper limit of measure X	99999.9999
lowerX	Lower limit of measure X	-99999.9999
upperY	Upper limit of measure Y	99999.9999
lowerY	Lower limit of measure Y	-99999.9999
upperAngle	Upper limit of the angle	180
lowerAngle	Lower limit of the angle	-180
upperCorrelation	Upper limit of corr.	100
lowerCorrelation	Lower limit of corr.	60
savemdlimg	Save registered model	0
thersDetail	Candidate Point Level	75
sort	Sort condition	1

searchNo	Search No.	0
upperCount	Upper limit of count judgement	32
lowerCount	Lower limit of count judgement	0
isMulti	Multiple output	0

### 9-10-3 Uploading Setting Values

Use the following procedure to upload the CSV file to which you downloaded the set values.

- 1** Switch to a scene containing the setting values to upload.
- 2** When loading data from external storage, insert an external storage device into the Sensor Controller.
- 3** In the Main Window, select [Settings download and upload tools] from the [Tool] menu.
- 4** Click [Upload] and select the scene with the set values to upload.

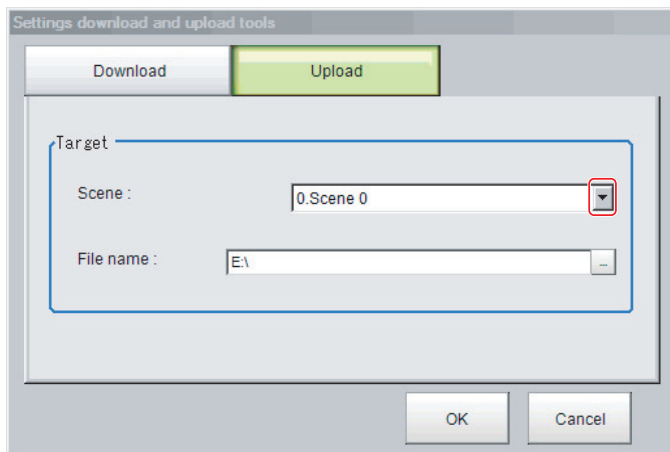

#### Important

To upload the file, set the character code to Unicode (UTF-8) with the Windows Notepad or another application, and save the file in CSV format.

- 5** Specify the folder and the name of the file to be loaded, and click [OK].

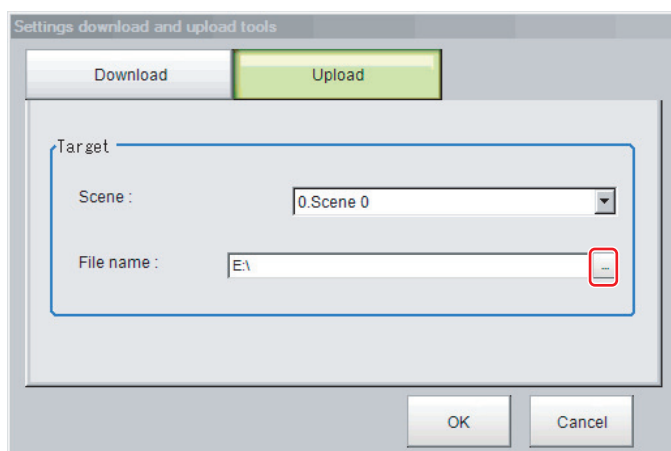

- 6** Click [OK].  
The data is uploaded.



**Important**

- When uploading a CSV file, set the character code to Unicode (UTF-8) with the Windows Notepad or another application. If a CSV file with a different character code, the text in the file is garbled.
- Model images and image data settings included in a scene need to be reflected, the scene in the uploaded CSV file must include those images and data. When it is uploaded at timings below, the scene does not include any images and data. Be sure to check setting values before uploading.
  - Just after the Sensor Controller startup
  - Just after switching scenes
  - Processing units to branch are used in the scene and the model images or image data are used in the branch destination
- If data with fewer units than the scene data to be loaded is uploaded, the parts that do not exist in the CSV file will not change.

Example:

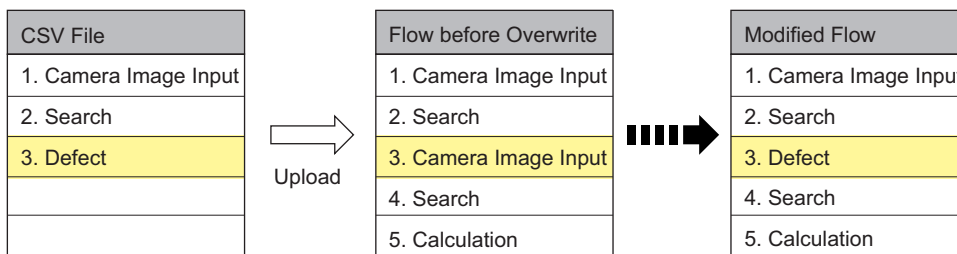

In this example, the processing item for unit 3 will be changed from Camera Image Input to Defects. The parts that do not exist in the CSV file (4. Search processing item and 5. Calculation processing item in the flow) will not change.

## 9-11 Saving/Loading Layout Settings [Layout Upload, Download Tool]

You can save the layout of the Main Window in a file and load the settings.



### Additional Information

- This tool cannot be used with remote operation from a PC.
- With this tool, layouts 0 to 8 are collectively saved to or loaded from a file.

### Saving the Layout Settings for the Main Window to a File

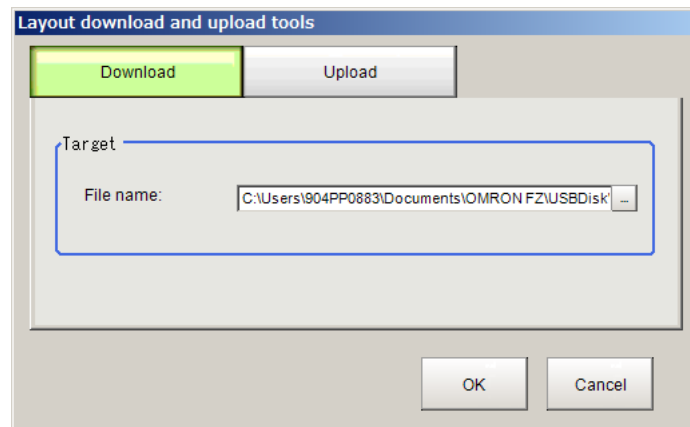

- 1** In the Main Window, select [Layout download and upload tools] from the [Tool] menu.
- 2** Click [Download] and specify the destination folder and file name.
- 3** Click [OK].  
The data will be saved to the save destination.

## Loading the Layout Settings for the Main Window from a File

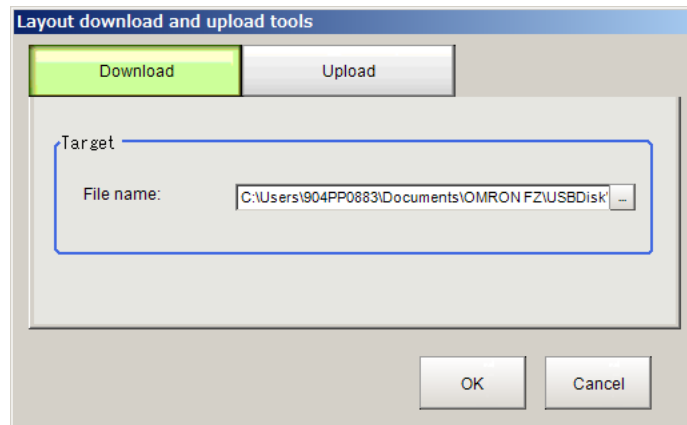

- 1** In the Main Window, select [Layout download and upload tools] from the [Tool] menu.
- 2** Click [Upload] and specify the source folder and file name.
- 3** Click [OK].  
The layout setting data will be loaded.



# 10

## Advanced Usage

---

<b>10-1 Remotely Operating the Controller [Remote Operation]</b>	<b>10-3</b>
10-1-1 Environment Settings	10-5
10-1-2 Connection Method for Remote Operation	10-10
10-1-3 Terminating Remote Operation	10-13
10-1-4 Differences from Local Operation and Limitations	10-14
<b>10-2 Multi-trigger Imaging Processing with Any Timing [Multi-trigger Imaging]</b>	<b>10-15</b>
10-2-1 Settings for Multi-trigger Imaging	10-16
10-2-2 Restrictions	10-17
10-2-2 Restrictions	10-17
10-2-4 About Multi-input Function (Multi-trigger Imaging)	10-23
10-2-5 Troubleshooting	10-28
<b>10-3 Limiting User Operations [Security Settings]</b>	<b>10-29</b>
10-3-1 Setting Accounts (Account List)	10-29
10-3-2 Setting Layout Restrictions	10-33
10-3-3 Setting User Group Operation Restrictions	10-34
10-3-4 Saving/Loading/Deleting the Security Settings	10-36
<b>10-4 Recording the Operation History [Operation Log]</b>	<b>10-40</b>
10-4-1 Using the Operation Log	10-40
10-4-2 Operation Log Format	10-43
<b>10-5 Setting the Keyboard Layout for the Controller [Keyboard Layout Selection Tool]</b>	<b>10-44</b>
<b>10-6 Switching User Accounts</b>	<b>10-45</b>
10-6-1 Logging in	10-45
10-6-2 Logging out	10-46
<b>10-7 Customizing Communication Commands [Communication Command Macro]</b>	<b>10-47</b>
<b>10-8 Extending the Functions in a Measurement Flow or Scene [Scene Control Macro Tool]</b>	<b>10-48</b>
<b>10-9 Positioning workpieces for stage and robot applications [Alignment Function]</b>	<b>10-49</b>
10-9-1 Overview	10-49

10-9-2	Execution of Calibration .....	10-52
10-9-3	Troubleshooting .....	10-59
10-9-4	Alignment .....	10-60
10-9-5	Alignment Processing Items .....	10-67

# 10-1 Remotely Operating the Controller [Remote Operation]

With a PC on your network, you can remotely operate processing items editing or actual measurements to be performed on the Sensor Controller. This feature is only available with an Ethernet connection.



## Additional Information

Remote Operation Tool and simulation software can be downloaded for free if you register as a member. For details, please check the member registration sheet that is included in the sensor controller.



## Precautions for Correct Use

A Sensor Controller window cannot be operated or displayed simultaneously on multiple PCs on a network.



## Precautions for Correct Use

The physical storage location of the setting data and data saving destination is on the Sensor Controller.

For instance, the following usage is possible.

- (1) Using one specific PC handles GUI operations such as editing processing items and changing settings for inspection and measurement on multiple lines.

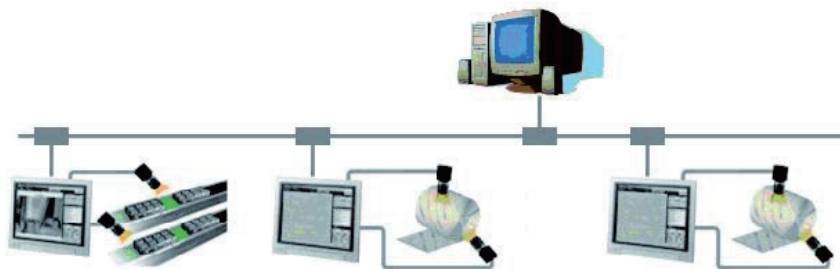

- (2) Measurement windows on Multi-line Random Trigger Mode are possible to be operated with individual window respectively.

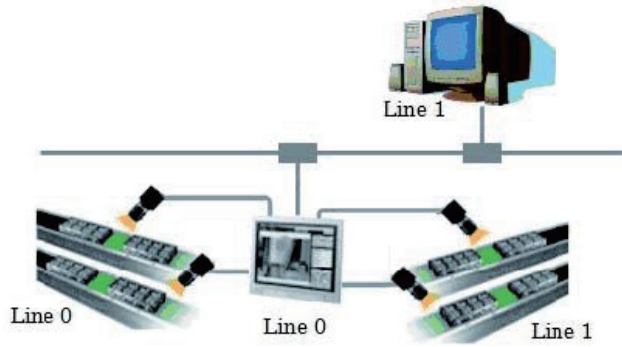

- (3) By changing a mode to the non-stop adjustment mode, adjustments are remotely available without stopping the line measurement.

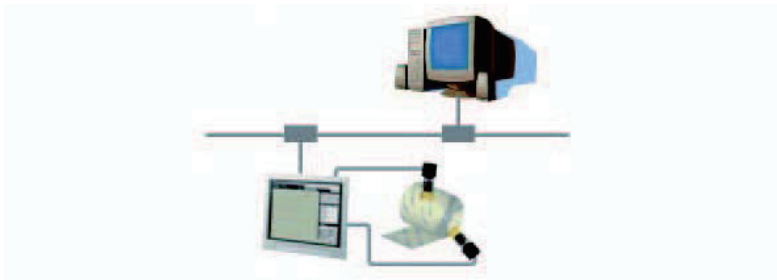

## 10-1-1 Environment Settings

The following preparations are required on the Sensor Controller and a remote operation PC respectively to launch the remote operation.

- Sensor Controller: Set up a server for the remote operation.
- Remote operation PC: Arrange communications and GUI environments for the remote operation. Install the Remote Operation Tool to the remote operation PC.



### Precautions for Correct Use

Make sure that the software version installed on the remote operation PC should be the same as that on the Sensor Controller.

## Recommended Operating Conditions for the Remote Operation PC

The recommended operating conditions for the remote operation PC are below.

Name	Description
CPU	Intel Pentium Processor (SSE2 or higher)
OS	Windows 7 Professional (32/64 bit) or Enterprise (32/64 bit) or Ultimate (32/64 bit), Windows 10 Pro (32/64 bit) or Enterprise (32/64 bit)
Memory	2 GB (3 GB or more recommended)
Free capacity in hard disk	2 GB or more
Display	Resolution: 1,280 x 1,024 dots or higher Display color: True Color (32 bits)
Network	10BASE-T compatible network (100BASE-TX recommended)

To use the remote operation tool, Microsoft .NET Framework 3.5 must be installed.



### Precautions for Correct Use

In the remote operation, the following port numbers are used to communication with the Sensor Controller.

- 9900 + Line number (e.g. port 9900 for line 0)
- 9910 + Line nubmer (e.g. port 9910 for line 0)
- 9920 + Line number (e.g. port 9920 for line 0)

Line Numbers: FH: 0 to 7, FH-L/FHV/FZ5: 0 to 1

If these ports are disabled due to security settings of your PC or the domain security policy, the remote operation is not available.

Reconsider the security settings of your PC or the domain security policy, or ask your domain security administrator.

## Setting Network

Perform the network settings on the Sensor Controller and the remote operation PC respectively. If the network address part of an IP address for the Sensor Controller is different from that for the remote operation PC, the connection for the remote operation is not available.



### Additional Information

With the remote operation PC, the network settings for the Sensor Controller is possible. For details, refer to the *Network Settings for Sensor Controller (With Remote Operation PC)* on page 10-8.

For FHV series, follow the above procedures to set the network for the Sensor Controller.

### ● Network Settings for Remote Operation PC

Set the IP address for the remote operation PC.

- 1 Open the "Local Area Connection Properties" on the remote operation PC.

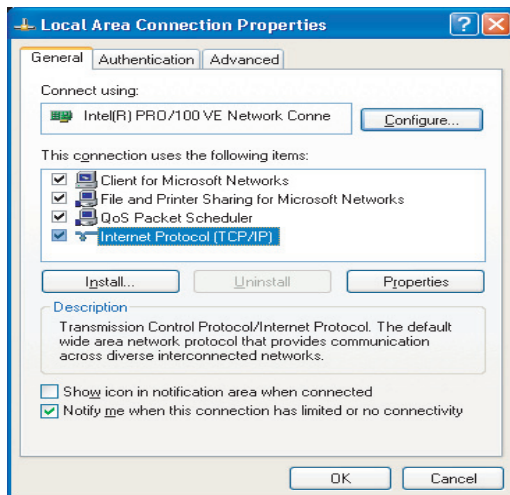

- 2 Input the IP address.

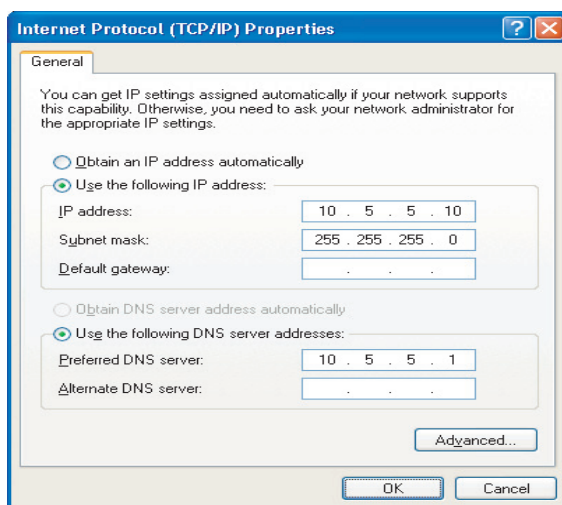

## ● Network Settings for Sensor Controller (With Sensor Controller)

Enable the remote operation on the Communications Module Setting and input the IP address.

- 1 In the Main window, select [System settings] → [Startup] → [Startup setting] from the [Tool] menu. Select "ON" for the Remote Operation in the "Communication module select" area.

Language Setting	Basic	Communication	Operation mode
Communication module select			
Serial(Ethernet)		Normal(UDP)	
Serial(RS-232C/422)		Normal	
Parallel		Standard Parallel I/O	
Fieldbus		OFF	
Remote Operation		ON	



### Additional Information

For FHV series, even OFF for the Remote Operation is selected, the connection for the remote operation cannot be disabled.

- 2 Click [Data save] to save the settings and restart the Sensor Controller.
- 3 In the Main window, select [System settings] – [Communications] – [Ethernet (\*\*\*\*\*)] from the [Tool] menu. Set the IP address.  
The (\*\*\*\*\*) area indicates the [Serial (Ethernet)] contents set in the above step 1 "Communication module select".

Address setting	
<input type="radio"/> Obtain an IP address automatically	
<input checked="" type="radio"/> Use the following IP address	
IP address:	10 5 5 100
Subnet mask:	255 255 255 0
Default gateway:	10 5 5 100
DNS server:	10 5 5 100
Preferred WINS server:	0 0 0 0
Alternate WINS server:	0 0 0 0
Address setting 2	
<input type="radio"/> Obtain an IP address automatically	
<input checked="" type="radio"/> Use the following IP address	
IP address:	10 5 6 100
Subnet mask:	255 255 255 0
Default gateway:	10 5 8 100
DNS server:	10 5 6 100
Preferred WINS server:	0 0 0 0
Alternate WINS server:	0 0 0 0
Input/Output setting	
Input mode:	Normal
Input form:	ASCII
Output IP address:	0 0 0 0
Input port No.:	9600
Output port No.:	-1 (-1: Same number Input port No)

## ● Network Settings for Sensor Controller (With Remote Operation PC)



### Precautions for Correct Use

The network settings for the Sensor Controller set with this procedure is temporary. Since the settings are discarded with restarting the Sensor Controller or power off, follow the procedures of *Network Settings for Remote Operation PC* on page 10-6 after the remote operation connection.

- 1 From the [Start] menu on your PC, select [All Programs] - [OMRON] - [FZ\_FH Series] - [FH\_FHV Launcher].

FH/FHV Launcher window appears.

- 2 Click the [Remote Operation Tool] button.

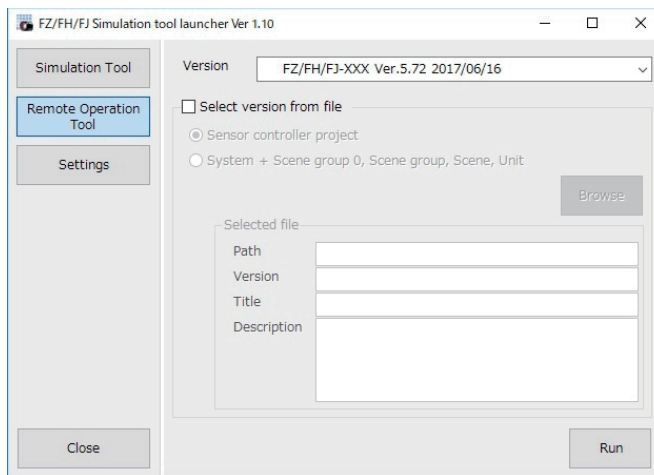

- 3 In the [Version], select the version of the measurement application of the sensor controller to be controlled remotely.

- 4 Click the [Run] button.

Note that the Sensor Controller must be placed in a measurement capable state.



### Precautions for Correct Use

Do not connect or disconnect the [Remote Operation Tool] during a measurement or the system running.

- 5 Click [Browse].

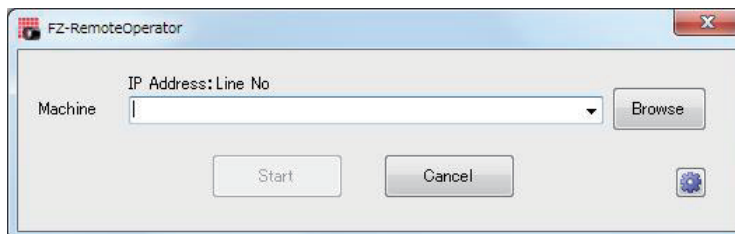

A "Network reference" list will be displayed.

When you run the simulation software of the sensor controller on the remote operation side PC, the simulation software information may be displayed in the Network reference list.



- 6 Select your target Sensor Controller in the list and click [Set Network].

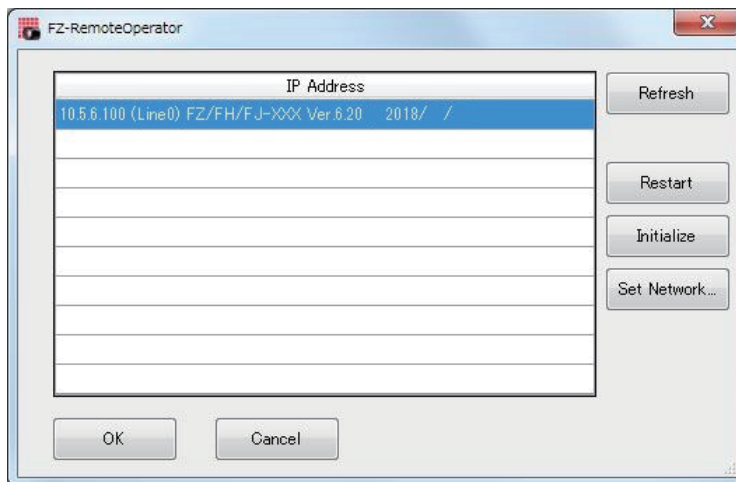

- 7 Set the IP address for the Sensor Controller on the "Network setting".

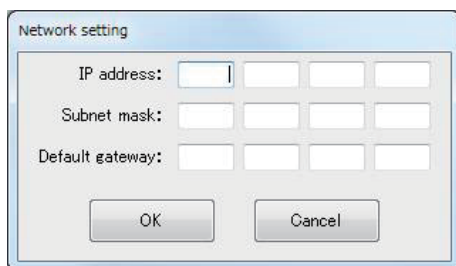

- 8 Click [OK].  
The IP address is set to the Sensor Controller.
- 9 On the network reference list, click [Refresh] to check the IP address setting is reflected.

#### Precautions for Correct Use

The reflection of IP address settings may take time. If it were not reflected, click [Refresh] again.

#### Precautions for Correct Use

If a bad IP address or an IP address overlapped with a device on the same network are set, an IP address different from your Setting will be displayed on the list like (169.254. xx. xx). Perform this procedure to set a valid IP address.

## 10-1-2 Connection Method for Remote Operation



### Precautions for Correct Use

If Ethernet cables are broken during the remote operation, Remote Operation Tool and the Sensor Controller may be improperly operated.

After terminating the Remote Operation Tool return the Sensor Controller to the normal state using Restart or Initialize buttons on the Remote Operation Tool.

If the Remote Operation Tool cannot be terminated with [End] in the file menu, terminate the process of FZ-PanDA.exe from the task manager.

- 1 From the [Start] menu on your PC, select [All Programs] - [OMRON] - [FZ\_FH Series] - [FH\_FHV Launcher].  
FH/FHV Launcher window appears.
- 2 Click the [Remote Operation Tool] button.

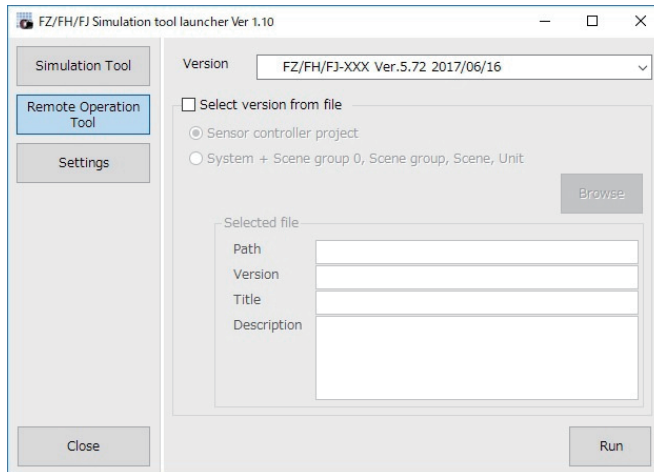

- 3 In the [Version], select the version of the measurement application of the sensor controller to be controlled remotely.
- 4 Click the [Run] button.  
Note that the Sensor Controller must be placed in a measurement capable state.



### Precautions for Correct Use

Do not connect or disconnect the [Remote Operation Tool] during a measurement or the system running.

- In the dialog displayed in the "Remote Operation Tool", select or directly input the IP address and "Line No." for the Sensor Controller to be connected.



**Additional Information**

Click [Browse] to check the IP addresses and Line numbers for connectable sensor controllers.

If the network address of an IP address were different from a remote operation PC, the remote operation cannot be connected even if the PC is displayed in the list.

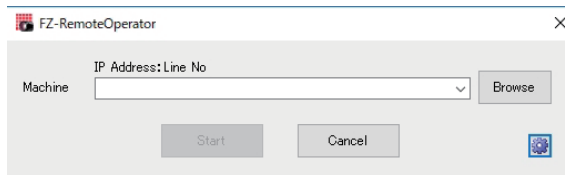

The "Line No" selected here is one of the following based on the system's operation mode.

Operation mode		Setting
Standard		Line No = 0
Double Speed Multi-input		Line No = 0
Non-stop adjustment	Measurement window	Line No = 0
	Non-stop adjustment window	Line No = 1
Multi-line random trigger*1	Line 0 side	Line No = 0
	Line 1 side	Line No = 1
	Line 2 side	Line No = 2
	Line 3 side	Line No = 3
	Line 4 side	Line No = 4
	Line 5 side	Line No = 5
	Line 6 side	Line No = 6
	Line 7 side	Line No = 7

\*1. The FZ5-800/1100/1200 series Sensor Controller always has two lines (Line 0 and1), and the FH series Sensor Controller is capable to have up to eight lines. Set the line number based on the number of lines set in the Sensor Controller.

If a line number other than the above was selected, the remote operation cannot be connected to Sensor Controllers.

- Change the size of an image to transfer with the remote operation as necessary. Select (  ) to set.

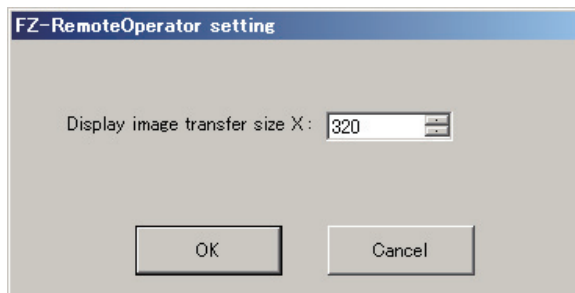

Setting item	Description
Display image transfer size (Size of the image to transfer)	Sets the width of the image displayed in the remote operation window. (default: 320)

- 7** Click [Start]. In the FH/FZ5 series, A "Remote operation time" message is displayed on the sensor controller when remote operation is established.

In the above state, you can not operate the Sensor Controller.

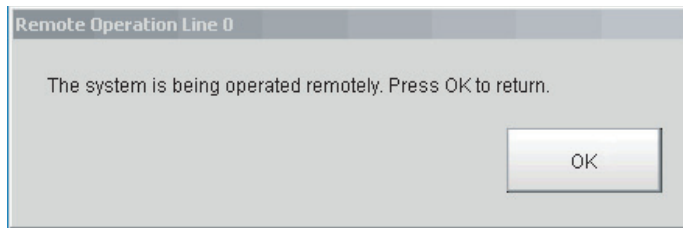

#### Additional Information

---

When the security setting has been set on a Sensor Controller to connect, inputting the password for a security setting item is requested on the Remote operation window.

---



#### Additional Information

---

When either the remote operation PC or the Sensor Controller is switched to Layout 8 by the layout switching, the operation on the Sensor Controller is also enabled during the remote operation. Note the followings when using this feature:

- In the layout switching, switch either the remote operation PC or the Sensor Controller to Layout 8, not both. If both of them are switched to Layout 8, only the remote operation PC can operate the Sensor Controller during the remote operation.
  - A layout can be switched to Layout 8 even during the remote operation. After switching the current layout to Layout 8 with the remote operation PC, close the remote operation dialog with the Sensor Controller. This allows you to operate the Sensor Controller directly while to continue the remote operation. To exit the remote operation in this state, terminate the Remote Operation Tool.
  - In Layout 8, an error dialog will not be displayed even if an error occurred. Instead, an error string is displayed on the Error Pane. When an error occurred, check it on the Error Pane.
  - In Layout 8, The Layout Modification Mode can handle the following panes only. When using panes other than them, use a layout other than Layout 8 for the normal remote operation.
  - Flow Display Pane
  - Image Pange
  - Judgement Pane
  - Error Pane
-

### 10-1-3 Terminating Remote Operation



#### Precautions for Correct Use

To terminate the [Remote Operation Tool], follow the procedures below.

If you do not follow the procedures below, such as the remote operation PC is shut down or it is terminated by the task manager, the Sensor Controller may not operate correctly.

### Terminating Remote Operation with Sensor Controller

This operation can not be used with the FHV series.

- 1 Click [OK] on the remote operation dialog displayed on the Sensor Controller.

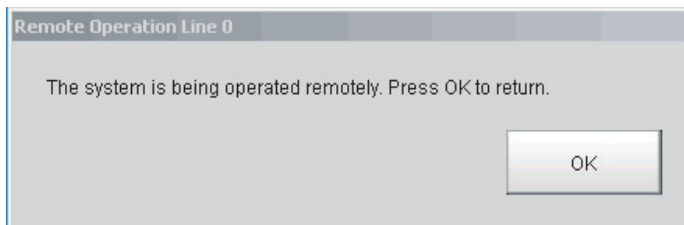

This allows the Sensor Controller to control itself.

For the remote operation PC, a message indicating the remote operation is disconnected is displayed.

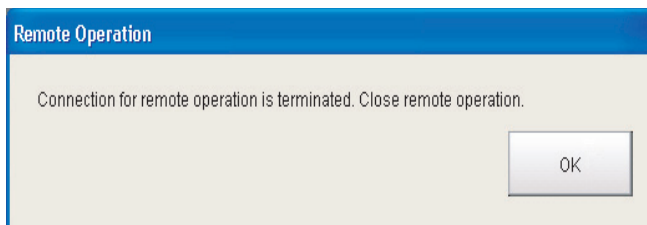

### Terminating Remote Operation with Remote Operation PC

- 1 Click [End] in the [File] menu on the Remote Operation Tool to terminate the remote operation by the remote operation PC.

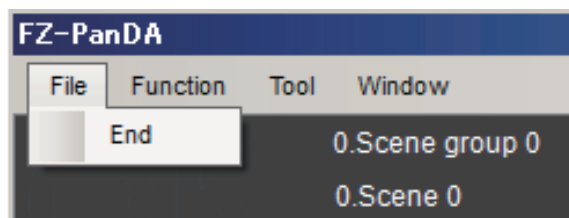

A message dialog on the Sensor Controller which indicates the remote operation is in process will be closed.

### 10-1-4 Differences from Local Operation and Limitations

There is no fundamental difference between local operation on the Sensor Controller and a remote operation.

Screens on the remote operation PC, however, are not ones of the Sensor Controller themselves.

Therefore, the following differences for its operation can come up.

Major differences are listed as follows:

Functions	Sensor Controller	Remote operation PC
Controller restart	Automatically restart	The Controller automatically restarts, while the remote operation PC waits to be shut down manually.
Screen capture	Screens of the Controller can be captured.	Screens of the Controller are captured (not the remote PC screens) FHV series does not support this.
Image display	Display camera images and figures and so on.	Depending on the "Display image transfer size (Size of the image to transfer)" setting, the roughness of the display image or figure display changes.
Unit Macro Unit Calculation Macro Scene Group Saving Destination Settings Communication Command Macro Line Maintenance	Available	Unavailable
Layout change	After the layout is switched, changes in layout settings will be reflected in the actual layout.	Changes are reflected immediately after changing the layout settings.  The layout display does not match between the Sensor Controller and the remote operation PC until the layout switching operation is performed on the sensor controller.
Drive information	The information of the drive that is connected to the Sensor Controller is can be checked.	Unavailable



#### Precautions for Correct Use

- The remote recovery dialog can be hidden behind a window of the non-stop adjustment mode and the multi-line random trigger mode, both of which have two or more windows. To confirm it, press Alt+Tab to switch between the windows.
- The remote operation communications will be disconnected if a network setting (such as the IP address, subnet mask, and default gateway) on the Sensor controller is modified using the remote operation function. Launch Remote Operation Tool to establish the connection again. The connection can fail immediately after a network setting has been changed. Please wait for a while before reconnecting.

## 10-2 Multi-trigger Imaging Processing with Any Timing [Multi-trigger Imaging]

This function can be used only with FH series and FZ5-800/1100/1200 series

The Multi-trigger Imaging processing item captures multiple images at user-defined timings and executes parallel measurement for each image. If the controller has consecutive STEP inputs, it performs measurement processing in each Multi-trigger Imaging Task in parallel. The system can perform high-speed processing and measurement at desired timings.

This function takes multiple images of a long and thin workpiece, e.g. a connector at certain timings. While the system takes images for multiple times, it executes measurement for each image in parallel. After that, measurement processing is performed based on the measurement results.

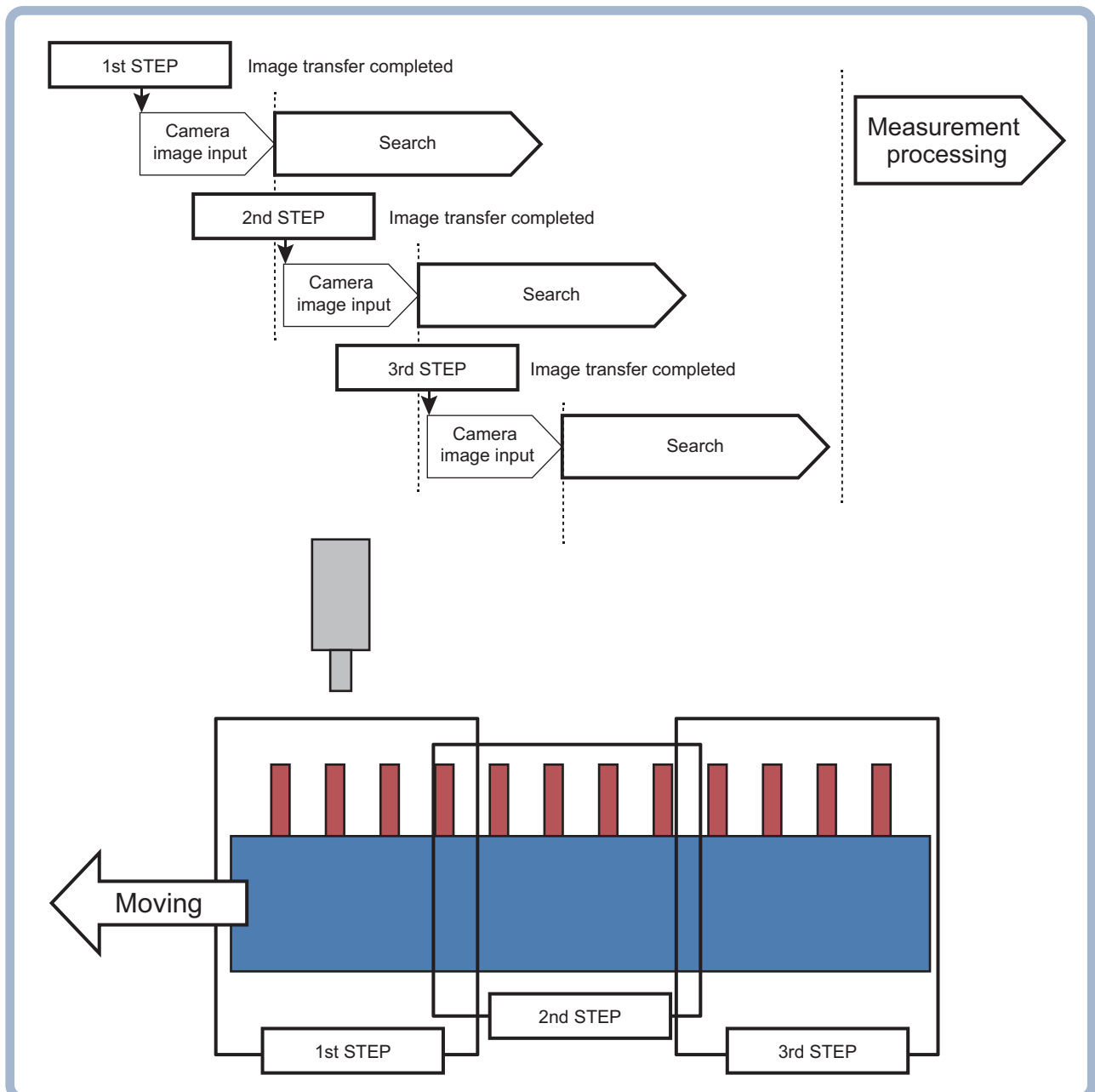

## 10-2-1 Settings for Multi-trigger Imaging

To use Multi-trigger Imaging function, enter the Multi-trigger Imaging, Multi-trigger Imaging Task and Multi-trigger Imaging End processing items as a group.

Flow configuration and execution image of Multi-trigger Imaging Processing

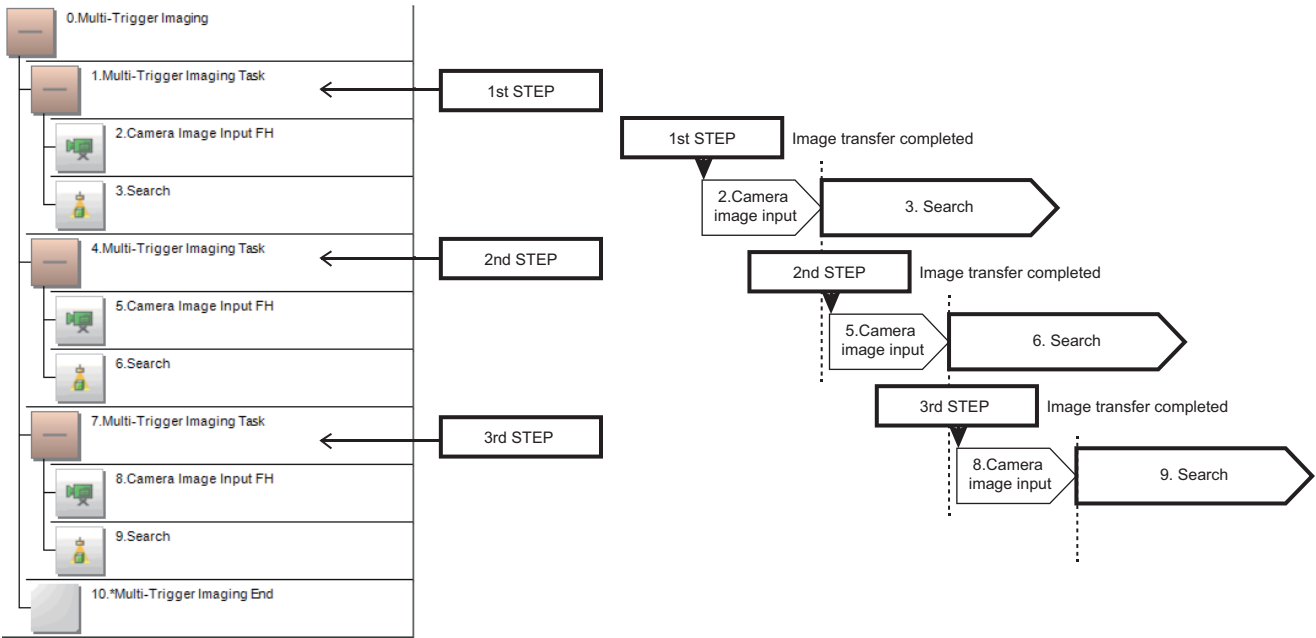

### ● Multi-trigger Imaging Settings

- The Multi-trigger Imaging Tasks that are placed between the Multi-trigger Imaging processing item and Multi-trigger Imaging End processing item are executed one by one with a STEP signal input in the order of flow settings.
- The processing range of Multi-trigger Imaging Task processing item is called as a Multi-trigger Imaging Task block. A task block is a group of measurement processes.
- The Multi-trigger Imaging Task block represents the following in the Measurement Flow.  
Range from Multi-trigger Imaging Task processing item to the point that comes just before the next Multi-trigger Imaging Task processing item.  
Range from Multi-trigger Imaging Task processing item to the point that comes just before the Multi-trigger Imaging Task End.
- If a STEP signal is not input, Multi-trigger Imaging Task processing item waits for the timeout time without executing the processing items included in the Multi-trigger Imaging Task block.  
When the first STEP signal is input, processing items in the first Multi-trigger Imaging Task block is executed. When the second STEP signal is input, it moves to the processing items in the second Multi-trigger Imaging Task block and they are executed.  
After processing for all the Multi-trigger Imaging Task blocks are completed reaching to the Multi-trigger Imaging End processing item, the processing items set afterward will be sequentially executed.
- The signals that can be used as an image capture trigger are STEP signal of parallel and Trigger signal of EtherCAT. Measurement executed by signals other than these signals or control command does not wait the STEP signal and flow is executed automatically as the controller does in the previous system. The signals that can be used as READY signal are READY signal of parallel and Trigger Ready of EtherCAT signal.
- STEP signal can be input only when the READY signal is ON.
- The Multi-trigger Imaging Task block must contain at least one Input Image processing item and executes processing that is assigned after Input Image processing item.



## Processing Items for Multi-trigger Imaging Processing

You can use the following three processing items.

Processing Item Type	Processing item name	Description
Capture Images [Input image]	Multi-trigger Imaging	Processing item which means a start of Multi-trigger Imaging
	Multi-trigger Imaging Task	Processing item which means a start of Multi-trigger Imaging Task Block. With a STEP input, a Multi-trigger Imaging Task Block is executed.
	Multi-trigger Imaging End	A processing item which means an end of Multi-trigger Imaging.

Refer to *Vision System FH/FHV/FZ5 Series Processing Item Function Reference Manual (Cat. No. Z341)* for the details of the settings of above items.

## Allocating Multi-trigger Imaging Processing Items

- Always use the Multi-trigger Imaging and Multi-trigger Imaging End processing items in pair.
- Do not place processing items between the Multi-trigger Imaging processing item and Multi-trigger Imaging Task processing item. Any processing units that are placed in this position will not be executed.
- Always allocate the Multi-trigger Imaging Task processing item between the Multi-trigger Imaging processing item and Multi-trigger Imaging End processing item.
- If you program a branch under a Multi-trigger Imaging Task processing item, make sure the branch stays within the range of the Multi-trigger Imaging Task processing item.

### 10-2-2 Restrictions

#### ● About STEP Signal Input

- The signals that can be used as STEP signals are STEP signal of parallel and Trigger input of EtherCAT. The signals that can be used as READY signal are READY signal of parallel and Trigger Ready of EtherCAT.
- Program the PLC so that STEP signal is not input while READY signal is OFF. When the STEP signal is input while the READY signal is OFF, the ERROR signal is output and the flow is ended without measuring units whose imaging has not been completed.
- Measurement executed by signals other than STEP signal or control command does not wait the STEP signal and flow is executed automatically as the controller does in the previous system.

#### ● About Multi-trigger Imaging

- Always set the Multi-trigger Imaging processing item to the start of measurement flow, processing unit 0.
- Always use only one Multi-trigger Imaging processing item in one flow.

#### ● About Multi-trigger Imaging Task

- Always insert at least one Multi-trigger Imaging Task processing item between the Multi-trigger Imaging and Multi-trigger Imaging End processing items.
- The maximum of 32 Multi-trigger Imaging Tasks can be allocated between the Multi-trigger Imaging and Multi-trigger Imaging End processing items.

### ● About Multi-trigger Imaging Task and Input Image processing items

- The Input Image processing items that can be allocated in the Multi-trigger Imaging Task processing item are the following.

FH series Sensor Controller

- [Camera Image Input FH], [Camera Image Input HDR], and [Camera Image Input HDR-Lite].

FZ5-800/1100/1200 series Sensor Controller

- [Camera Image Input], [Camera Image Input HDR], and [Camera Image Input HDR-Lite].

- Always use at least one Input Image processing unit within the processing range of Multi-trigger Imaging Task processing item (Multi-trigger Imaging Task block).
- When there are multiple Camera Image Input HDR processing items or Camera Image Input HDR-Lite processing items in one Multi-trigger Imaging Task block, the system will operate with the setting [Non-Multi-input] mode, even if you select [Multi-input] mode.
- When there are multiple Input Image processing items in one Multi-trigger Imaging Task block, the system will operate with the setting [Non-Multi-input] mode, even if you select [Multi-input] mode.

### ● Restrictions in allocating processing items

- Do not attempt settings like below by using "Conditional Branching" or "Selective Branching processing items."
  - Settings to move from WITHIN the range between Multi-trigger Imaging processing item and Multi-trigger Imaging End processing item to OUTSIDE of it, or that in reversed direction.
  - Settings to move between the Multi-trigger Imaging Task blocks.
- Do not allocate Input Image processing items to the following positions.
  - Position higher than Multi-trigger Imaging processing item (such as unit 0)
  - Position between the Multi-trigger Imaging processing item and Multi-trigger Imaging Task processing item.
- Do not refer the data between the Multi-trigger Imaging Task blocks for calculations.

### ● About parallel processing

- If parallel processing is activated (if you select ON for the [Parallel Execute] settings in the [System settings]), Multi-trigger Imaging Task block is executed in parallel. The processing items in a task block are not processed in parallel, but executed sequentially.
- The number of Multi-trigger Imaging Task blocks that can be performed in parallel is same as the number of CPU cores.
- If parallel processing is disabled, Multi-trigger Imaging Task blocks are executed sequentially.

### ● About image mode

- If the Image mode of the Image Window Setting is set as [Through], flow is executed automatically as the controller does in the previous system.

### 10-2-3 Setting Methods

This section explains the setting method to use the Multi-trigger Imaging.

#### Editing Measurement Flow

- 1 In the Main Window (layout 0), select [Function] [Edit Flow].
- 2 Select [0: Camera Image Input FH].
- 3 Select [Multi-trigger Imaging] processing item under the [Loading Images], and then click the [Insert] button.
- 4 The warning dialog is displayed. Click the OK button.

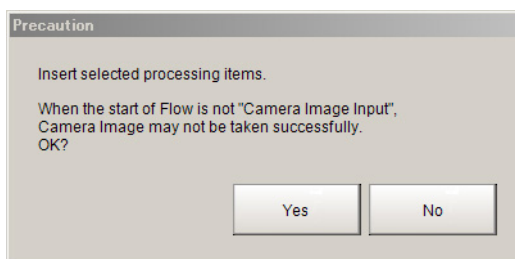

Two task blocks which consist of Multi-trigger Imaging Task and Camera Image Input FH will be added between the Multi-trigger Imaging and Multi-trigger Imaging End.

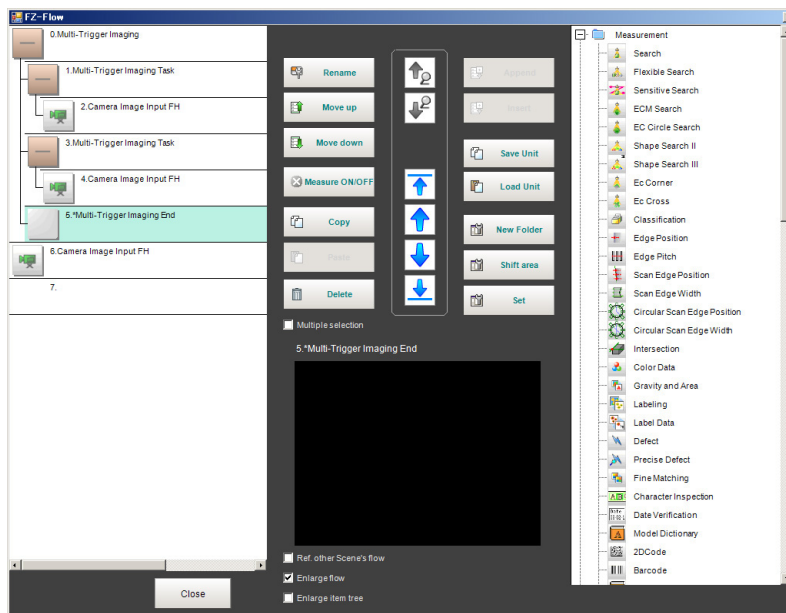

Example:

Block of Multi-trigger Imaging and Multi-trigger Imaging Task  
Multi-trigger imaging collapsed view.

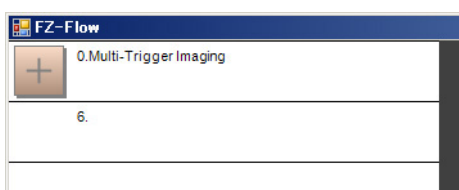

Multi-trigger Imaging Task collapsed view.

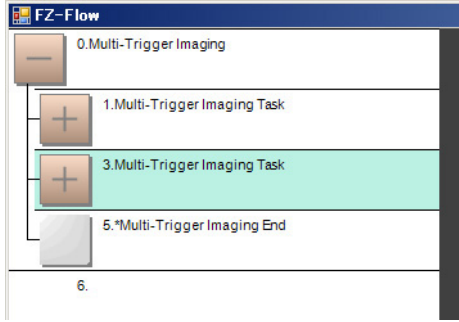

**5** Insert a processing item between two Multi-trigger Imaging Tasks.

Select a Multi-trigger Imaging Task that is placed just under the Multi-trigger Imaging Task to which a processing item is added. Click a processing item to add, and then click the [Insert] button.

Example: Inserting Search processing item

- Before clicking the [Insert] button

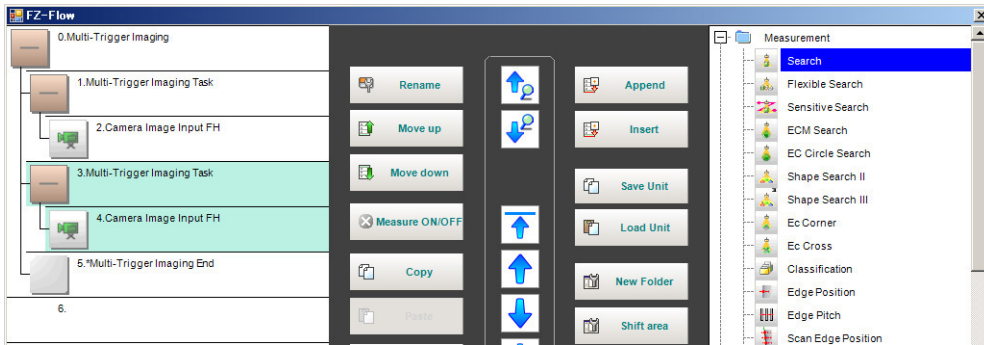

- After clicking the [Insert] button

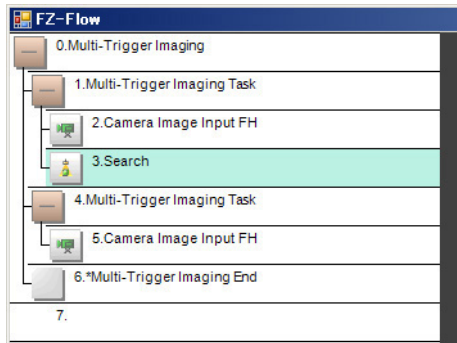

The Multi-trigger Imaging processing item is the parent, and everything up to the Multi-trigger Imaging End processing item is a child.

Additionally, the Multi-trigger Imaging Task processing item is the parent, and everything up to the step just before the next

Multi-trigger Imaging Task processing item or the Multi-trigger Imaging End processing item is a child.

The Multi-trigger Imaging End processing item is not displayed in the list of items. (It is registered as a set with the Multi-trigger Imaging processing item).

**● Precautions on Flow Editing**

- Editing operations on Multi-trigger Imaging blocks and task blocks, such as register, move, delete, copy, and paste, and unit save and load operations, are performed on the Multi-trigger Imaging block as a group.

You cannot delete a Multi-trigger Imaging End processing item by itself. If it is deleted, an error dialog will be displayed.

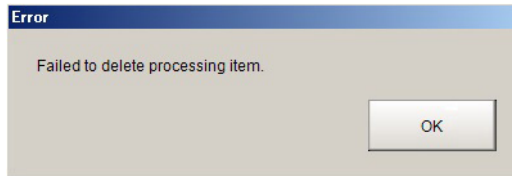

## Setting parameters of Multi-trigger Imaging Processing Items

Follow the steps below to configure the parameters of Multi-trigger Imaging Processing Items.

- 1 In the Main Window (layout 0), select [Function] - [Edit Flow].

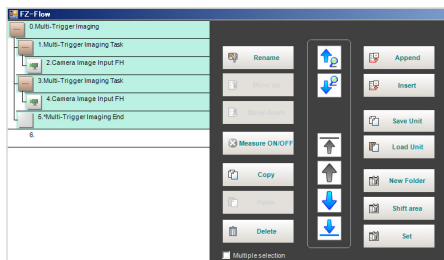

- 2 Select the [Multi-trigger Imaging] to configure.
- 3 Click the [Settings].
- 4 Select the mode and set the time for timeout.

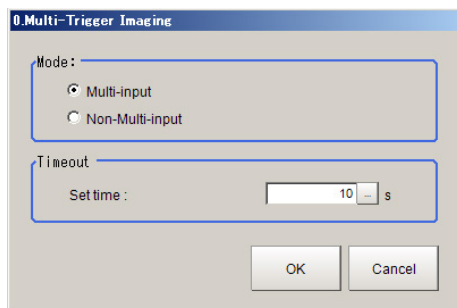

Setting item	Set value [Factory default]	Description
Mode	<ul style="list-style-type: none"> <li>• [Multi-input]</li> <li>• Non-Multi-input</li> </ul>	<p>Set the processing mode of Multi-trigger Imaging Task</p> <ul style="list-style-type: none"> <li>• Multi-input: Select this if Multi-input mode is used in the Multi-trigger Imaging Task. The Camera setting for the Input image processing item of the first Multi-trigger Imaging Task is applied to that for other Input image processing items that are executed in Multi-trigger Imaging Tasks.</li> <li>• Non-Multi-input: Cameras operate according to their own settings. The Camera setting for the Input image processing item of the Multi-trigger Imaging Task is applied to each execution of Input image processing items. Because Camera setting is executed at each execution of Input image preprocessing item, the time that READY signal stays OFF becomes longer by several ms to several tens of ms compared with that in Multi-input mode.</li> </ul>

Setting item	Set value [Factory default]	Description
Timeout	1 to 60 s [10]	Set the time for timeout of Multi-trigger Imaging Task block. It is a wait time between a Multi-trigger Imaging Task and the next one. When a STEP signal is not input within the timeout time after the READY signal turns ON, the Multi-trigger Imaging unit judgment will be NG.



### Important

In the following cases, the system operates in Non-Multi-input mode, regardless of the settings for Mode.

- Camera Image Input HDR or Camera Image Input HDR Lite is used.
- Multiple Input image processing items are used in one Multi-trigger Imaging Task block.
- FZ-SQ□□□□ camera is used with its light ON.
- Input image processing item is inserted outside of the range between Multi-trigger Imaging and Multi-trigger Imaging End processing items.

There are restrictions below when FZ-FQ□□□□ camera is used with its light ON.

- All Camera Image Input processing items operate with the settings for the Camera Image Input of the first Multi-trigger Imaging Task in the flow.
- The system operates in Non-Multi-input mode. (It takes longer time to turn ON the READY signal).
- When the light of FZ-FQ□□□□ camera is OFF, the camera operates in the same way as other camera does.

### 10-2-4 About Multi-input Function (Multi-trigger Imaging)

The Multi-input function allows sequential high-speed image input. Next STEP signal can be received when the Input image is completed.

Multi-input function can be used with Multi-trigger Imaging processing. Refer to the following application examples of Multi-trigger Imaging.

- Multi-trigger Imaging Flow Example

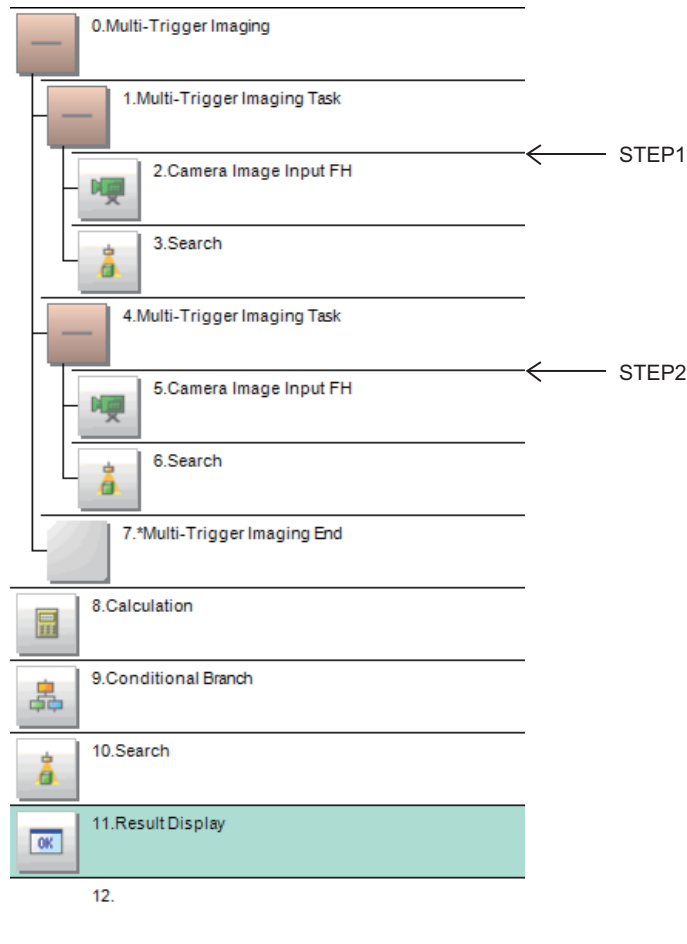

## Timing Chart

### ● Multi-input + Parallel processing ON

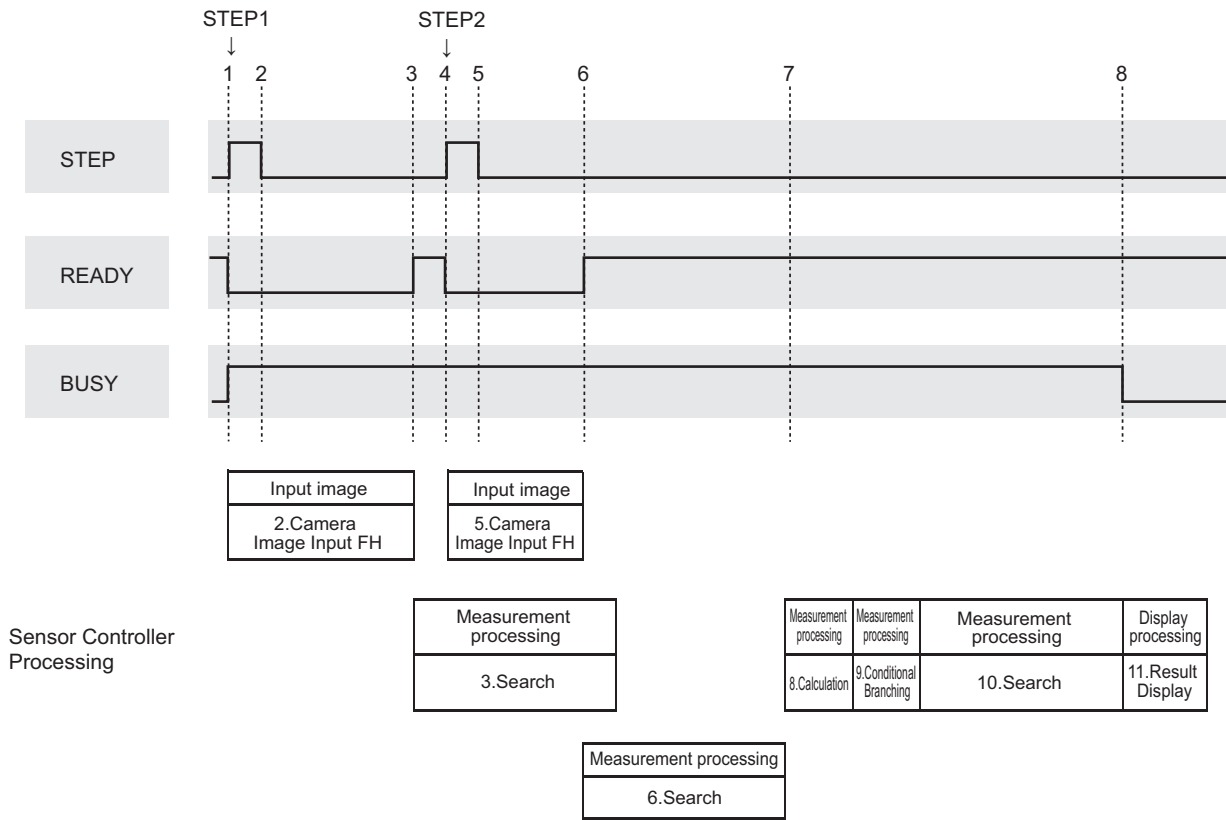

Sensor Controller Processing

1.	After checking if READY is ON and BUSY is OFF, turn ON the STEP (STEP1). When STEP turns ON, READY turns OFF and BUSY turns ON. Camera image (2 Camera image input FH) is input.
2.	After READY turns OFF and BUSY turns ON, turn OFF the STEP.
3.	Since multi-input mode is selected for this example, READY turns ON after completing Camera Image Input (2 Camera Image Input FH). After completing Input image (2 Camera Image Input FH), measurement processing (3 Search) is executed.
4.	After checking if READY is ON, turn ON the STEP (STEP2). When STEP turns ON, READY turns OFF. Since multi-input mode is selected for this example, Input image (5 Camera Image Input) is performed in the same way as 2 Camera Image Input FH.
5.	After READY turns OFF, turn OFF the STEP.
6.	After completing Input image (5 Camera Image Input FH), READY turns OFF. In this example, parallel processing is activated; Multi-trigger Imaging Task blocks are performed in parallel. After completing Input image (5 Camera Image Input FH), measurement processing (6 Search) is executed.
7.	After "1 Multi-trigger Imaging Task" and "4 Multi-trigger Imaging Task" are completed, measurement processing (8 Calculation) which is set after the Multi-trigger Imaging End will be performed.
8.	After measurement processing is completed, BUSY turns OFF. Display processing (11 Result Display) is performed.



● Multi-input + Parallel processing OFF

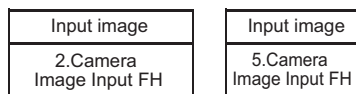
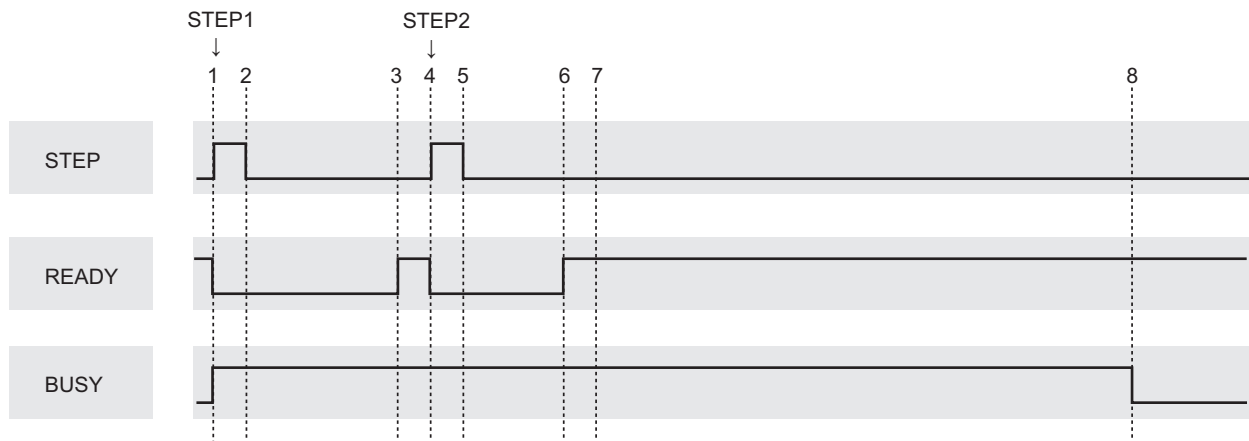

Sensor Controller Processing

Measurement processing	Measurement processing	Measurement processing	Measurement processing	Measurement processing	Display processing
3.Search	6.Search	8.Calculation	9.Conditional Branching	10.Search	11.Result Display

1.	After checking if READY is ON and BUSY is OFF, turn ON the STEP (STEP1). When STEP turns ON, READY turns OFF and BUSY turns ON. Camera Image Input (2 Camera Image Input FH) is executed.
2.	After READY turns OFF and BUSY turns ON, turn OFF the STEP.
3.	Since multi-input mode is selected for this example, READY turns ON after completing Camera Image Input (2 Camera Image Input FH). After completing image input, measurement processing (3 Search) is executed.
4.	After checking if READY is ON, turn ON the STEP (STEP2). When STEP turns ON, READY turns OFF. Since multi-input mode is selected for this example, Input image (5 Camera Image Input) is performed in the same way as 2 Camera Image Input FH.
5.	After READY turns OFF, turn OFF the STEP.
6.	After completing Input image (5 Camera Image Input FH), READY turns OFF.
7.	Since Parallel processing is disabled, "6 Search" measurement processing is executed after "3 Search" measurement processing is completed. The measurement is performed according to the flow setting.
8.	After measurement processing is completed, BUSY turns OFF. Display processing (11 Result Display) is performed.

● Non-Multi-input + Parallel processing ON

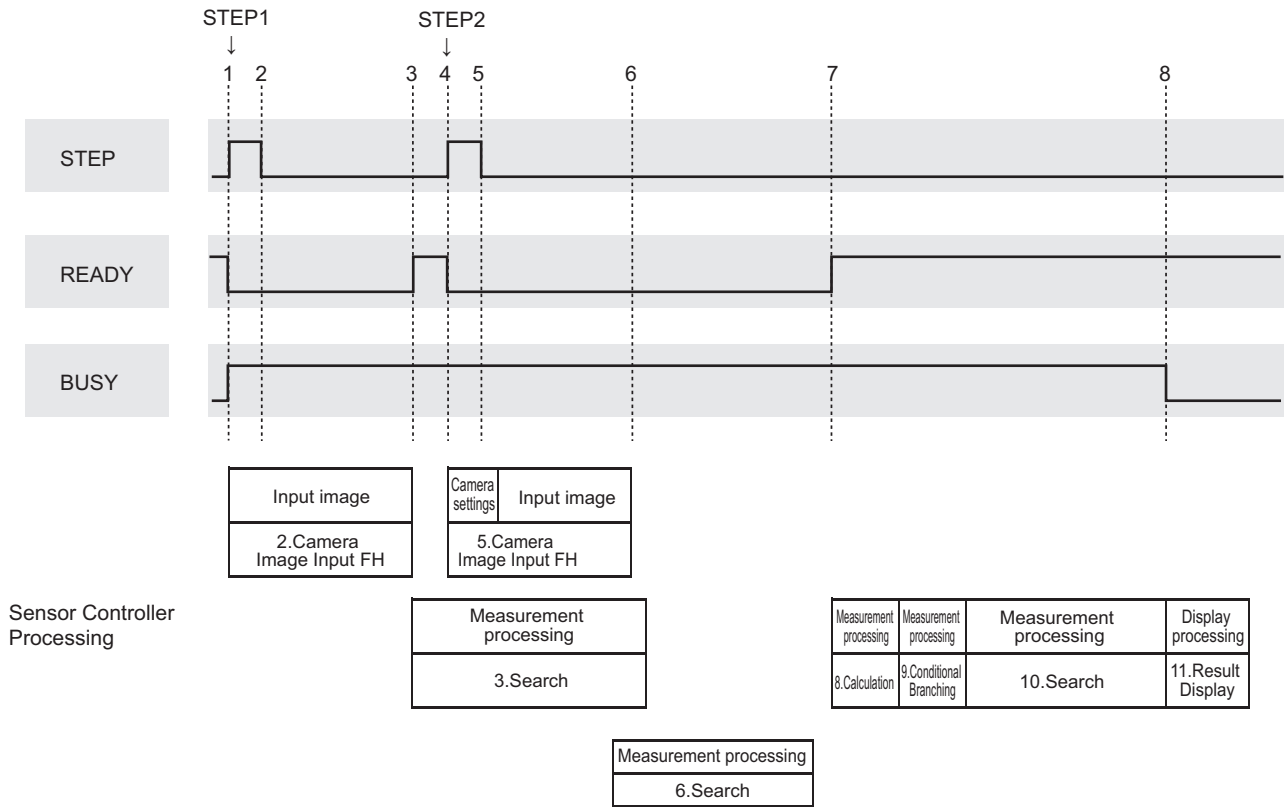

1.	After checking if READY is ON and BUSY is OFF, turn ON the STEP (STEP1). When STEP turns ON, READY turns OFF and BUSY turns ON. Camera Image Input (2 Camera Image Input FH) is executed.
2.	After READY turns OFF and BUSY turns ON, turn OFF the STEP.
3.	After Camera Image Input (2 Camera Image Input FH), READY turns ON. Measurement processing (3 Search) is executed.
4.	After checking if READY is ON, turn ON the STEP (STEP2). When STEP turns ON, READY turns OFF. Since Non-Multi-input mode is selected, processing starts with camera settings for 5 Camera Image Input.
5.	After READY turns OFF, turn OFF the STEP.
6.	After completing Camera Image Input (5 Camera Image Input FH), measurement processing (6 Search) is executed without turning ON the READY.
7.	After measurement processing (6. Search) is completed, READY turns ON. After "1 Multi-trigger Imaging Task" and "4 Multi-trigger Imaging Task" are completed, measurement processing (8 Calculation) which is set after the Multi-trigger Imaging End is performed.
8.	After measurement processing of Multi-trigger Imaging End is completed, READY turns ON and BUSY turns OFF. Display processing (11 Result Display) is performed.

● Non-Multi-input + Parallel processing OFF

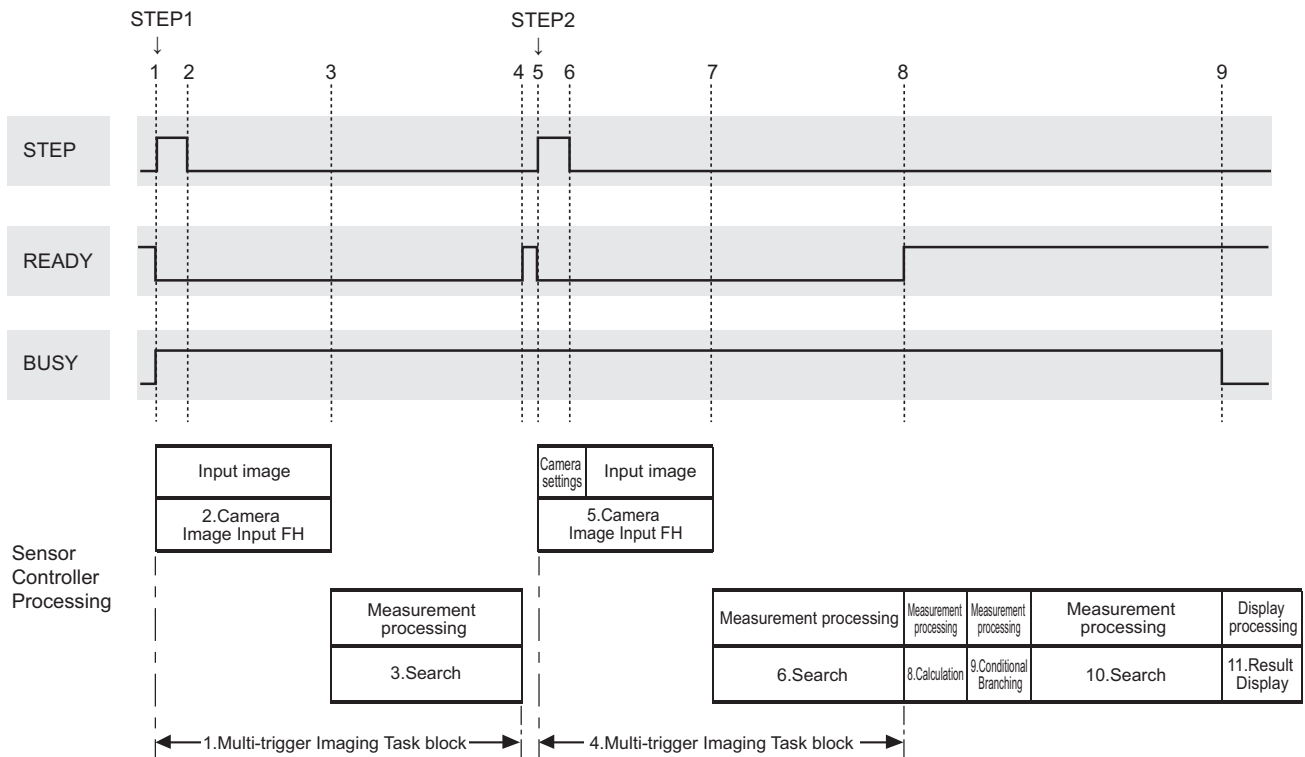

1.	After checking if READY is ON and BUSY is OFF, turn ON the STEP (STEP1). When STEP turns ON, READY turns OFF and BUSY turns ON. Camera image Input (2 Camera image input FH) is executed.
2.	After READY turns OFF and BUSY turns ON, turn OFF the STEP.
3.	Since both Multi-input mode and Parallel processing are disabled, measurement processing (3 Search) is executed after Camera Image Input without turning ON the READY.
4.	After measurement processing (3. Search) is completed, READY turns ON. (The READY remains OFF until the "1 Multi-trigger Imaging" Task block is completed).
5.	After checking if READY is ON, turn ON the STEP (STEP2). When STEP turns ON, READY turns OFF. Since Non-Multi-input mode is selected, processing starts with camera settings for "5 Camera Image Input".
6.	After READY turns OFF, turn OFF the STEP.
7.	Since both Multi-input mode and Parallel processing are disabled, measurement processing (6 Search) is executed after Camera Image Input without turning ON the READY.
8.	After measurement processing (6. Search) is completed, READY turns ON. (The READY remains OFF until the "4 Multi-trigger Imaging" Task block is completed). 8 Calculation that comes after Multi-trigger Imaging End is performed.
9.	After Multi-trigger Imaging End measurement processing is completed, BUSY turns OFF. Display processing (11 Result Display) is performed.

## 10-2-5 Troubleshooting

Symptom	Correction
<ul style="list-style-type: none"> <li>STEP signal is input, but it is not received by FH.</li> <li>When STEP signal is input, ERROR signal is output.</li> </ul>	<p>STEP signal can be input when READY signal is OFF.</p> <p>Change the program of the PLC so that it checks if READY signal is OFF when the STEP signal is input.</p>
<ul style="list-style-type: none"> <li>The flow ends unintentionally when the STEP signal is input.</li> </ul>	<ul style="list-style-type: none"> <li>Two or more blocks that contain Multi-trigger Imaging to Multi-trigger Imaging End can be set in the flow. Modify the flow so that the flow has only one block. The Image mode setting in the Image Pane can be [Through]. Change the mode to other than [Through].</li> <li>The STEP signal may not be input within the timeout time. Set the longer timeout time so that timeout will not occur.</li> </ul>
<ul style="list-style-type: none"> <li>The screen is too bright or too dark.</li> </ul>	<p>The camera settings cannot be reflected because Multi-input mode is selected.</p> <p>Change the mode to [Non-Multi-input] from the Main screen.</p>
<ul style="list-style-type: none"> <li>Camera conditions for image taking is same, but it takes longer time to take images.</li> </ul>	<p>[Non-Multi-input] can be selected. After capturing an image, parameter setting processing is performed for next image capturing.</p> <p>Change the mode to [Multi-input] from the Main screen.</p>
<ul style="list-style-type: none"> <li>Judgment of Multi-trigger Imaging Unit is NG.</li> </ul>	<p>STEP signal cannot be input within the set timeout time after READY signal turns ON.</p> <p>Change the timeout time so that timeout will not occur before inputting STEP signal.</p>
<ul style="list-style-type: none"> <li>The calculation result in Multi-trigger Imaging Task is unexpected value.</li> </ul>	<p>The data of other Multi-trigger Imaging Task processing items can be referred.</p> <p>Refer to the data after Multi-trigger Imaging is completed, because the processing of the items is not finished while the Multi-trigger processing is in progress.</p>
<ul style="list-style-type: none"> <li>Not all images of camera image input are saved.</li> </ul>	<p>[OFF] can be selected for [Multiple image logging].</p> <p>Select [ON] for [Multiple image logging] to save all camera image input of Multi-trigger Imaging.</p>

## 10-3 Limiting User Operations [Security Settings]

You can restrict access to the Sensor Controller for specific users and user groups. Because you can set a password for each user and can enable or disable operations for each user group, you can flexibly manage users to match the way they use the system, for example system administrators, onsite managers, and system operators.

It is also possible to link to the operation log and get operation records for the currently logged-in user.

### 10-3-1 Setting Accounts (Account List)

This section explains how to add, edit, and delete user accounts.



#### Important

In order to add, edit, or delete a user account, you must be logged in with a user account belonging to group UG0. The default user name and password are both “Administrator”.

### Adding Accounts

Use the following procedure to add a user account.

- 1** In the Main Window, select [Security settings] from the [Tool] menu. The [Security settings] dialog box is displayed.
- 2** Click [Account list] in the Item Tab Area.

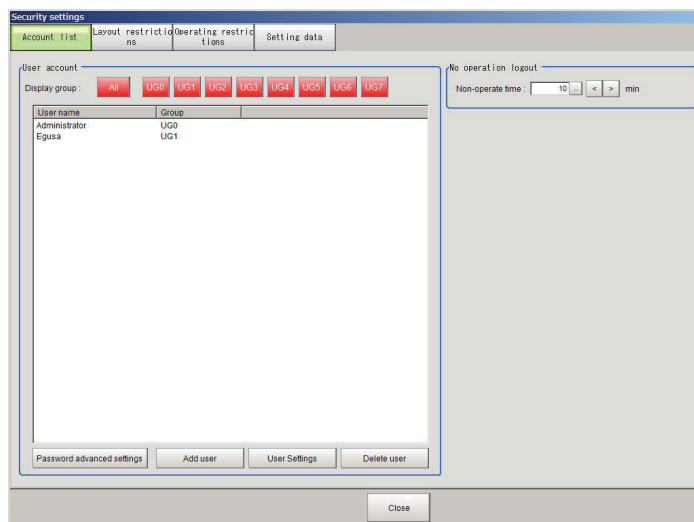

- 3** Click the [Add user] button.

**4** Set the user information.

Parameter	Description
User name	Enter a user name of 1 to 20 single-byte alphanumeric characters. The names are case sensitive.
User group ID	Select the user group (UG0 to UG7) to which the user being added will belong. If you select [UG0], the user can use all functions. Refer to <i>10-3-3 Setting User Group Operation Restrictions</i> on page 10-34.
Password	Enter the login password for the user being added. The password for the new user must have one or more characters. The password for a transferred user may also be 0 characters.
Confirm password	Enter the login password again.

**5** Click [OK].

The user account is added and displayed in the user account list.

**Important**

The number of user accounts is not limited and can be added as long as there is sufficient free memory. If the amount of used memory increases and the amount of free memory becomes insufficient, you can not add accounts. Please check the memory consumption (physical memory (the remaining capacity) or available data memory) when you add user accounts. Refer to *3-4 Checking the Memory Consumption and Percentage of Memory Used* on page 3-31 and *3-3 Checking System Information* on page 3-27.

## Editing an Account

Use the following procedure to change the user group or password for the user account.

- 1** In the Main Window, select [Security settings] from the [Tool] menu.  
The [Security settings] dialog box is displayed.
- 2** Click [Account list] in the Item Tab Area.
- 3** Click the user to change the user group or password for.

User name	Group
aaa	UG0
Administrator	UG0
Super/visor	UG1
bbb	UG1
Operator	UG2
ccc	UG2
ddd	UG3

- 4** Click the [Change group] button or the [Change password] button.
- 5** Change the user group or password.

- 6 Click [OK].  
The user information is changed.

## Deleting an Account

Use the following procedure to add a user account.

- 1 In the Main Window, select [Security settings] from the [Tool] menu.  
The [Security settings] dialog box is displayed.
- 2 Click [Account list] in the Item Tab Area.
- 3 Click the user to delete.

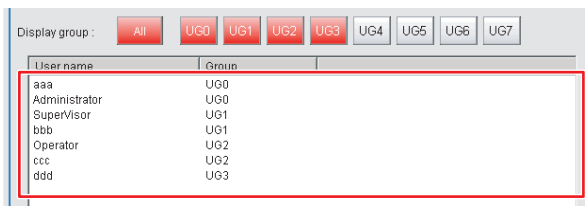

- 4 Click the [Delete user] button.  
A confirmation message is displayed.
- 5 Click [Yes].  
The user account is deleted.

## Setting Automatic Logout

Use the following procedure to set the length of time before an account is automatically logged out when no operation is performed.

- 1 In the Main Window, select [Security settings] from the [Tool] menu.  
The [Security settings] dialog box is displayed.
- 2 Click [Account list] in the Item Tab Area.
- 3 In the [No operation logout] area, set the non-operation time.



Parameter	Set value [Factory default]	Description
Non-operate time	1 to 999 [10]	Set the length of time before an account is automatically logged out when no operation is performed. Set the time in minutes.

## Setting Password Advanced Settings

Set the number of minimum characters, mixing character type, and expiration period.

- 1** In the Main Window, select [Security settings] from the [Tool] menu.  
The “Security settings” dialog box is displayed.
- 2** Click [Account list] in the Item tab area.
- 3** Click [Password advanced settings].  
The “Password advanced settings” dialog is displayed.

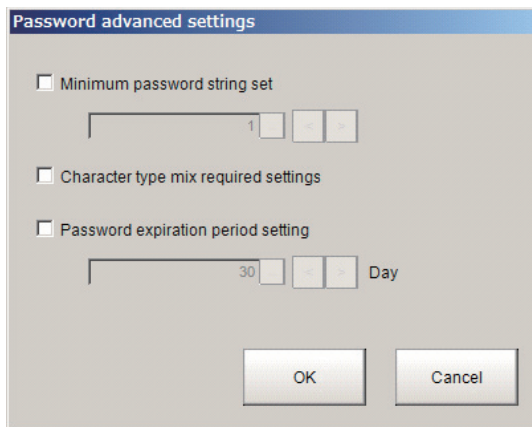

Setting item	Setting value [Factory default]	Description
Minimum password string set	• Checked	Specifies the number of minimum characters for the password in the units of characters.
	• [Unchecked]	
	0 to 255 [1]	
Character type mix required settings	• Checked	Specifies whether or not mixing character types such as alphanumeric character and symbol.
	• [Unchecked]	
Password expiration period setting	• Checked	Specifies the expiry date of the set password in units of day.
	• [Unchecked]	
	1 to 999 [30]	

- 4** Check your desired item to set a value.



## 10-3-2 Setting Layout Restrictions

Set the right to change the layout for each user group.

You can restrict the functions that can be used by each user group.

The layouts that can be restricted are as follows:

Security setting items
Use of layout 0
Use of layout 1
Use of layout 2
Use of layout 3
Use of layout 4
Use of layout 5
Use of layout 6
Use of layout 7
Use of layout 8
Switch layout
Layout modification
Layout setup

- 1** In the Main Window, select [Security settings] from the [Tool] menu.  
The [Security settings] dialog box is displayed.
- 2** Click the [Layout restrictions] tab in the Item Tab Area.
- 3** The layout restriction settings are changed.  
Layout settings that are not selected are not restricted.

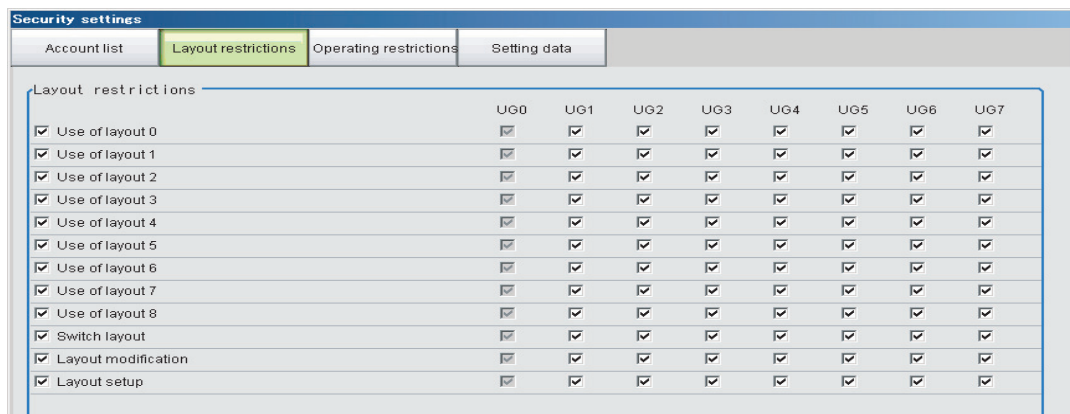

- 4** Click the [Close] button.

### 10-3-3 Setting User Group Operation Restrictions

You can restrict the functions that can be used by each user group.

You can set restrictions for the following items.

Security setting item
End
Measure
Scene switch
Scene maintenance
Edit flow
Clear measurement
Clear logging image
Screen capture
Save last logging image
Data save
Save to file
Load from file
System initialization
System restart
Transfer data
Nonstop data transfer
Start/stop of operation log
System information
NG analyzer
System settings
Registered image management
Customize I/O command
Unit setting mode starting
Nonstop adjustment mode starting
Image window layout setting
Information window setting
Tool button setting
Image container window setting
Flow window setting
Image window setting
Text window setting
Error window setting
Output
Continuous meas.
Select image
Auto Re-meas.
The Judgement result monitor
Re-meas.
LCD off
User data tool
Setting download and upload tools
Image file save
Flow Viewer
Calibration support tool
Update Standard position tool
Conversion scene group data tool
Custom dialog tool
Custom dialog

Security setting item
Scene Group Saving Destination Settings
Scene Control Macro Tool
Master scene update
Master scene edit
Configuration copy
Line Maintenance
Keyboard layout selection tool
Device information storage tool
Position setting (Manual Position Setting unit)

- 1 In the Main Window, select [Security settings] from the [Tool] menu.  
The [Security settings] dialog box is displayed.
- 2 Click the [Operating restrictions] tab in the Item Tab Area.
- 3 Select the operations to restrict.  
Operations that are not selected are not restricted.

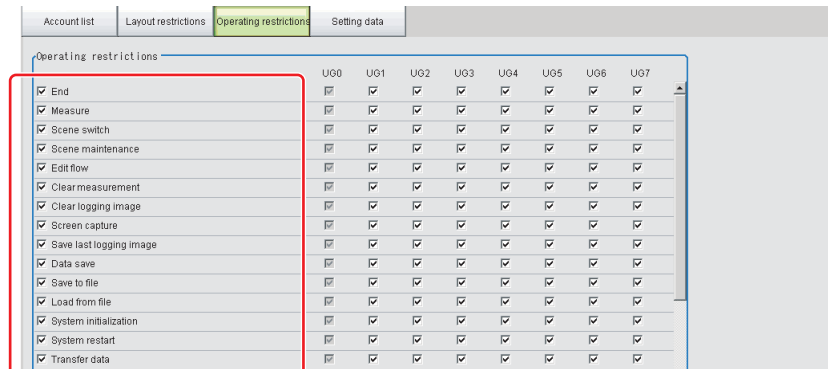

- 4 Select the operations to be permitted by user groups (UG1 to UG7) on the right side.  
Operations that are not selected cannot be used by users belonging to that group.

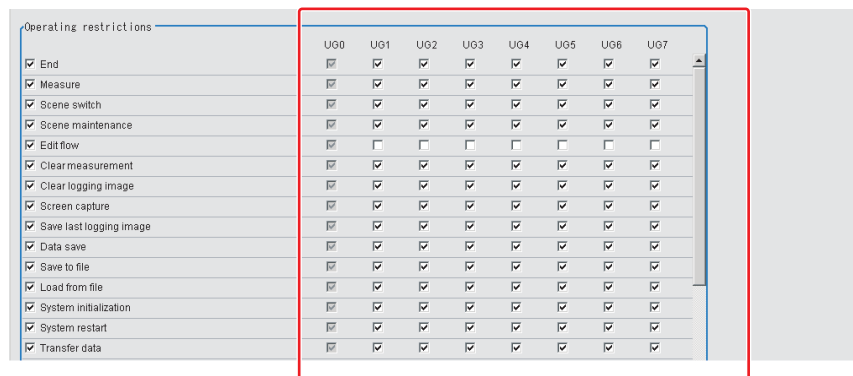

- 5 Click the [Close] button.  
Operation restrictions are set for the user groups.

### 10-3-4 Saving/Loading/Deleting the Security Settings

You can save user account and user group settings (security settings). You can load or delete saved settings.

Account setting data is not included in BKD files.

#### Saving Security Settings

You can save user account and user group settings to a RAM disk or an external storage device.



#### Important

- During data transfer to external storage, do not remove the external storage device until the transfer is completed. Data and the external storage may be corrupted.
- Timing for Saving Data in the Controller  
Data is saved to the Controller only when the [Security setting] dialog box is closed with the [Close] button.  
When the login window is ended by selecting [Cancel], data is not saved to the Controller. The set contents or loaded contents are cleared by when the Controller is restarted.
- Remote Operation Security  
The security settings are synchronized, but for users who are logged in, the security settings are managed separately on the local side and remote side. Therefore, even if users are logged in on the local side, they must log in again on the remote side.

- 1 When saving data to external memory, insert an external storage device into the Sensor Controller.
- 2 In the Main Window, select [Security settings] from the [Tool] menu.  
The [Security settings] dialog box is displayed.
- 3 Click the [Setting data] tab in the Item Tab Area.

The screenshot shows the 'Security settings' dialog box with the 'Setting data' tab selected. It contains the following sections:

- Save to file:** A text input field for 'File name' with a question mark, and a 'Save' button.
- Load from file:** A text input field for 'File name' with a question mark, and a 'Load' button.
- Deletion of setting file:** A red warning message: 'All the current security settings will be deleted. Please be careful.' and a 'Delete' button.
- Shift of old security settings:** A red warning message: 'The current security settings will be overwritten. Please be careful.' and an 'Execution' button.
- Close:** A 'Close' button at the bottom center.

- 4 Specify the destination folder and file name in the [Save to file] area.
- 5 Click the [Save] button.

## Loading Security Settings

Use the following procedure to load a saved user account and user group settings into the Sensor Controller.



### Important

Note that some setting cannot be keep when you load the security setting saved as the older version than the current software version.

Refer to *Loading security settings from an older software version* on page 10-37.

- 1** If the settings were stored in external storage, insert the external storage device containing the security settings to load into the Sensor Controller.
- 2** In the Main Window, select [Security settings] from the [Tool] menu.  
The [Security settings] dialog box is displayed.
- 3** Click the [Setting data] tab in the Item Tab Area.
- 4** Select the file to load from the [Load from file] area.
- 5** Click the [Load] button.

### ● Loading security settings from an older software version

When loading security settings from a previous Sensor Controller software version, the settings that can be transferred will differ depending on the that previous software version. Refer to the following table. Confirm each setting item and reset as needed.

- (1) Loading the security settings in software version 4.12, or earlier.

Setting item	Keep	Discard
Password	OK	
Switch to ADJUST mode		OK
Non-stop adjustment mode		OK
RUN Control area		OK
RUN Tool box		OK



### Additional Information

For the password setting set in FZ4 Ver4.12, or earlier, refer to *Transferring Old Security Settings* on page 10-38.

(2) Loading the security settings in version from 4.20 to 4.24.

Setting item	Keep	Discard
Layout restrictions		
Switch to ADJUST mode		OK
Switch to RUN mode		OK
ADJUST Control area		OK
ADJUST Test measurement		OK
ADJUST flow		OK
ADJUST Detail result		OK
ADJUST Image display		OK
RUN Control area		OK
RUN flow		OK
RUN Detail result		OK
RUN Image display		OK
RUN Tool box		OK

(3) Loading the security settings in version 5.00, or later.

Keeps all of the security setting items including the software version of saved in the Sensor Controller.

## Deleting Security Settings

Use the following procedure to delete saved user accounts and user groups settings.



### Important

The current security settings are all deleted.

- 1** In the Main Window, select [Security settings] from the [Tool] menu.  
The [Security settings] dialog box is displayed.
- 2** Click the [Setting] tab in the Item Tab Area.
- 3** Click the [Delete] button in the [Deletion of setting file] area.  
The security settings are deleted and the following message is displayed.  
“User info logging in was changed now. Please log in again.”
- 4** Click [OK].  
The [Login] dialog box is displayed.  
Enter the default user and password “Administrator”.  
If the login dialog box is canceled, the [Security setting] dialog box is closed.

## Transferring Old Security Settings

Password settings that were made in FZ4 version 4.12 or earlier can be inherited.



### Important

This procedure will overwrite the current security settings.

- 1** In the Main Window, select [Security settings] from the [Tool] menu.

The [Security settings] dialog box is displayed.

**2** Click the [Setting] tab in the Item Tab Area.

**3** Click the [Execution] button in the [Shift of old security settings] area.

The confirmation message, "The settings will be transferred and saved in the Controller. OK?" is displayed.

**4** Click [Yes].

The security settings are changed.

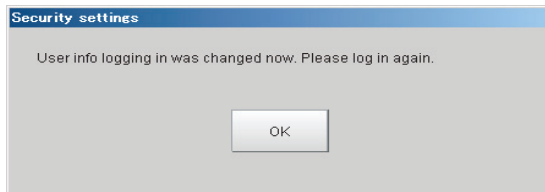

**5** Click [OK].

Enter the user name and password to log in again.

# 10-4 Recording the Operation History [Operation Log]

## 10-4-1 Using the Operation Log

The operation log automatically saves the contents of Controller operations and setting changes in a unique file delimited with semicolons (;). Setting content changes are recorded as a time series, which makes change management possible.

### Setting the Operation Log

Set the destination to save the operation log. Also set whether to start recording the operation log during startup.

Sample output of an operation log: This log records the date, time, user name, and the operation that was performed.

```
2012/09/10 13:08:41;Administrator;SetSystemData,"OperationLog","enabled","1";0
2012/09/10 13:08:41;Administrator;MeasureStart;0
2012/09/10 13:08:41;Administrator;GetSceneGroupNo;0
...
```

- 1** In the Main Window, select [System settings] – [Other] – [Operation log setting] from the [Tool] menu.  
The [Operation log settings] dialog box is displayed.
- 2** Set the parameters for the operation log.

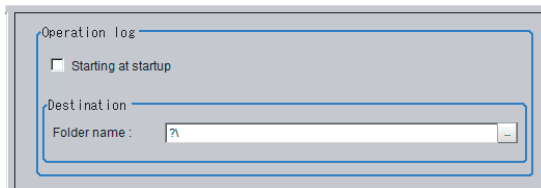

Parameter	Description
Starting at startup	Select this check box to record the operation log from startup. The setting will be reflected from the next time that the system starts up.
Folder name	Specify the destination folder name. The operation log file name is the date and time at which the operation log was started plus the .log extension. Example: 2012-09-29_12-39-04.log <ul style="list-style-type: none"> <li>• In Multi-line Random Trigger Mode, set a save destination for each line. The file name is the date and time at which the operation log was started + the line number + the "log" extension. Example: 2012-09-29_12-39-04_Line0.log. This setting only takes effect after you save the data and restart the system.</li> <li>• In non-stop adjustment mode, the non-stop adjustment log is saved with the file name <i>(date and time at which the operation log was started)_Nonstop.log</i>.</li> </ul>

- 3** Click [Apply].





### Important

- If the save destination of operation log does not exist or an insufficient memory is available, the logging operation will fail. In this case, an logging error appears, refer to *11-1 Error Messages and Troubleshooting* on page 11-2.
- The saving the operation log may fail at the Sensor Controller start-up because a recognition delay for external storage happens depending on models or number of connections of external storage.  
Use the Device Information Storage Tool when the save destination of operation log is set to external storage.  
Refer to *3-6-2 Device Information Storage Tool* on page 3-35.

## Checking and Changing the Operation Log Status

Use the following procedure to check the current operation log function status

- 1 In the Main Window, select [Operation log] from the [Function] menu.  
The current operation log status is displayed.

To change the current operation log status, click either [Start] or [Stop].

To close the dialog box without changing the current operation log status, click the [Cancel] button.

Dialog Box When Operation Log Is Stopped

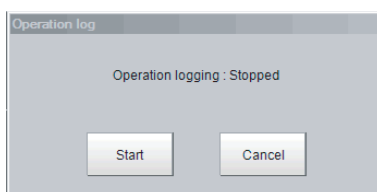

Dialog Box While Operation Log Is Being Recorded

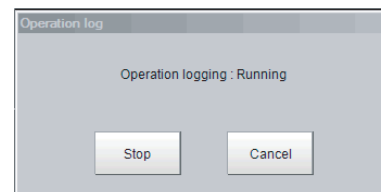

## Loading an Operation Log File

When the log file is set to be saved to the Controller, use the following procedure to load the file.

- 1 Insert an external storage device into the Controller.
- 2 In the Main Window, select [Save to file] from the [Function] menu.  
The [Save to file] dialog box is displayed.
- 3 Click the [Copy files] tab.

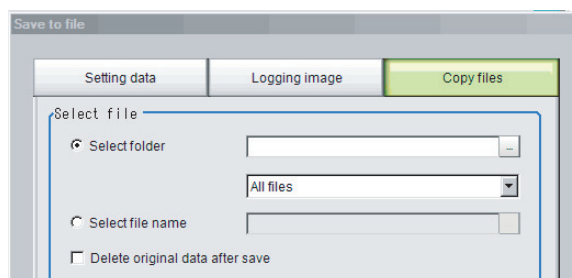

- 4** Select [Select folder], click [...], and specify the a folder.

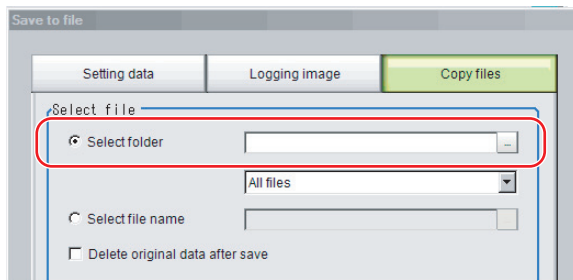

- 5** Select the operation log (\*.log).

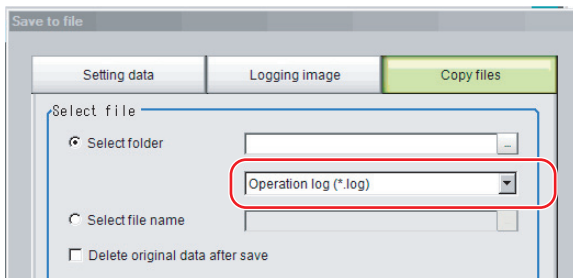

- 6** Specify the destination.

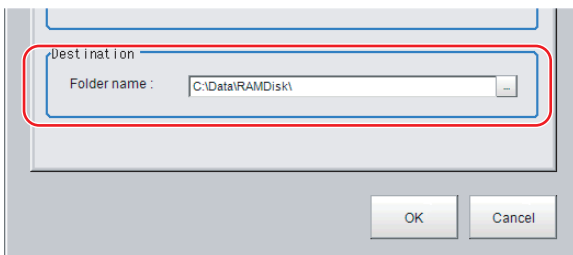

- 7** Click [OK].

For details on operation logs, refer to *10-4-2 Operation Log Format* on page 10-43.



### Important

The contents of operation log files cannot be checked on the Controller. On a computer, open the file with a text editor or change the delimiter characters to semicolons (;) with spreadsheet software.

## 10-4-2 Operation Log Format

- The operation log is stored in a file indicating the date and time as follows in the directory specified as the save destination.

YYYY-MM-DD\_HH-MM-SS.log (example: 2012-08-20\_12-00-00.log)

- The date and time shown in the file name is the date and time at which the log file was created.
  - The maximum size for a log file is about 100 KB. If a log file is larger than 100 KB, the log is written into a new file from the first record over 100 KB.
  - When the log is stopped, then started again, a new log file is created.
  - Also during operation log execution, if the save destination directory setting is changed, at that point in time, a new log file is created in the new save destination.
  - Use spreadsheet program or other spreadsheet software to open the log file. If the characters are corrupted, set the character code to UTF-8 with the BOM.
- Basically, information is saved when the API (application program interface) is executed. The information for one piece of API information is written into the log file as one record.

The format for each record that is written to the log file is as follows: The four data items, the execution date and time, user name, input information, and output information, are delimited with semicolons. At the end of the record, a line feed (CR+LF) is entered.

*(Execution date and time); (user name); (input information); (output information) [LF+CR]*

Examples:

2012/08/20 12:00:00;user0;SetSystemData,"XX","YY","ZZ";0

2012/08/20 12:00:01;user0;GetSystemData,"XX","YY";0,"ZZ"

Execution date and time	The date and time at which this API was executed.
Username	The name of user that is currently logged in. If no one is logged in, the character string "no login" is entered.
Input information	The API name is followed by supplemental information (mostly API arguments), delimited with commas.
Output information	The API return value is followed by supplemental information (mostly information gotten by the API), delimited with commas.

For the operation log input information written in the operation log file, refer to *A-14 Operation log input information list* on page A-40.

## 10-5 Setting the Keyboard Layout for the Controller [Keyboard Layout Selection Tool]

Set up the keyboard arrangement for the controller screen keyboard, or for a USB connected keyboard.



### Additional Information

- The layout of the keyboard can be changed with this tool only for FZ5-8□□/FZ5-11□□/FZ5-12□□ and FH series controllers.
- Settings made with this tool can not be copied to another controller with the Configuration copy tool, etc. They must be set on each individual controller used.



### Important

Do not turn off the power to the controller while using the tool. The controller may not start properly next time.

## Setting the Keyboard Layout

- 1 On the main screen, select [Tool] – [Keyboard layout selection tool].

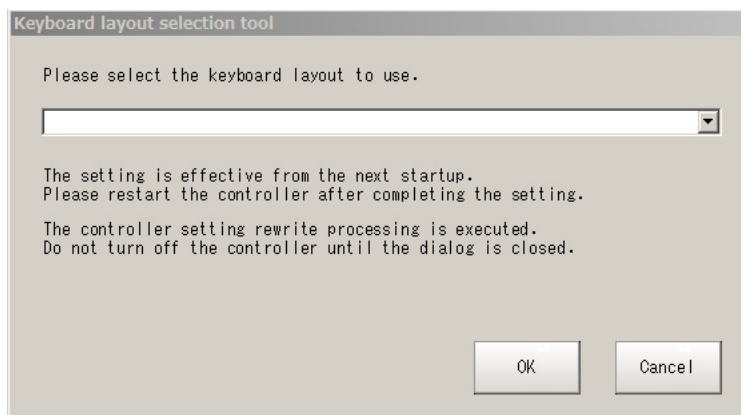

- 2 Select the keyboard layout language.

Language	Keyboard layout
Japanese	00000411 (Japanese)
English	00000409 (English)
Chinese (Simplified)	00000804 (Chinese (Simplified) - US Keyboard)
Chinese (Traditional)	00000404 (Chinese (Traditional) - US Keyboard)
German	00000407 (German)
Italian	00000410 (Italian)
French	0000040c (French)
Spanish	0000040a (Spanish)
Korean	00000412 (Korean)
Vietnamese	0000042a (Vietnamese)
Polish	00000415 (Polish)

- 3 Click [OK].

The keyboard layout you set will be applied after restarting the controller.

## 10-6 Switching User Accounts

After a user account is set up, you can log in and log out with the registered user account. If you try to execute an operation you do not have the right to use, the login dialog box is displayed even though you are already logged in. In that case, log in with a user account that has the right to execute that operation.

### 10-6-1 Logging in

When you log in, you can execute those operations that the user account you logged in with has the right to execute.



- 1 Click the [Login] icon in the Measurement Information Display Area.  
The [Login] dialog box is displayed.

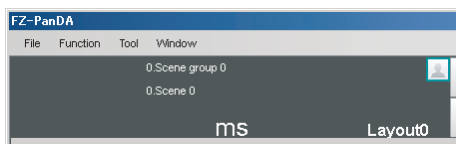

- 2 Enter the user account and password.  
If the login fails, "The user name or the password is wrong" is displayed.  
Enter the correct user name and password.

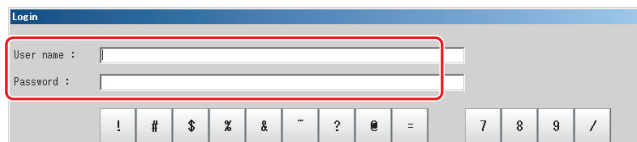

- 3 Click [OK].  
The login icon switches to the logged-in state.

## 10-6-2 Logging out



### Additional Information

- If an automatic logout time is set, you will be automatically logged out
- if you do not perform any operations at all for the set time period. If you do not perform any operation, such as changing the display, after an automatic logout, the [Login] icon will still appear in the logged in state.  
The icon display will be updated if you change from the Main Window to a settings dialog box or an operating dialog box, or if you change to another layout.

- 1 Click the [Login] in the Measurement Information Display Area.  
The [Login] dialog box is displayed.

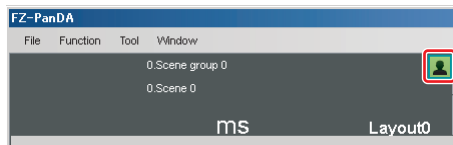

- 2 Click the [Logout] button.

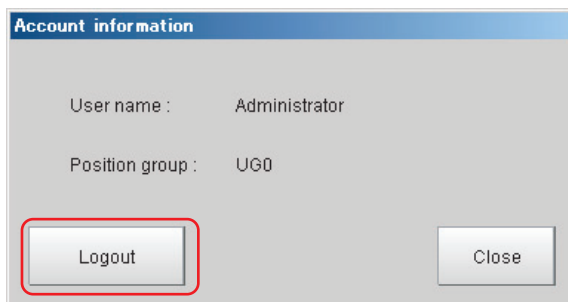

- 3 Click [OK].  
The login icon changes to the logged-out state.

## 10-7 Customizing Communication Commands [Communication Command Macro]

You can define your own communication commands for the Sensor Controller.

You use this to create functionality that is not available in the standard communication commands, or to perform more than one process with a single communication command.

This function can not be used with the FHV series.

Example: To tell the Controller to change scenes and then execute a measurement from an external device.

Without using communication command macro	Using communication command macro
You must send two standard communication commands: the Switch Scene command (scene) and the Measurement command (measure).	Create a measurement command (mymeasure) that is set to execute scene switching followed by measurement processing.  One execution of the mymeasure command actually executes two commands, the scene command and measure command, which simplifies the control logic from the PLC or other external device.

User-defined communication commands are registered as a character string of the command name for the non-procedure communications protocol, or as a command number from 0 to 255. These commands are stored in the main memory of the Sensor Controller.

The maximum number of characters that can be used for the Communication Command Macro is 1024 characters.

If you send a registered communications command from the external device to the Sensor Controller, the Sensor Controller recognizes it and performs the specified processing.

Refer to Components of the Setting Screen of the Communication Command Macro Tool and How to Configure Settings in the *Vision System FH/FZ5 Series Macro Customize Functions Programming Manual* (Cat. No. Z367).

## 10-8 Extending the Functions in a Measurement Flow or Scene [Scene Control Macro Tool]

---

Using this tool, can complement or extend the operation of measurement flow or Scene.

This function can not be used with the FHV series.

This tool is useful when the following cases:

- When add the processing unit and measurement flow.
- When the manage data common in the multiple processing units.

For details, refer to *Description of the Setting Screen of the Scene Control Macro Tool and How to Configure Settings* in the *Vision System FH/FZ5 Series Macro Customize Functions Programming Manual* (Cat. No. Z367).



# 10-9 Positioning workpieces for stage and robot applications [Alignment Function]

An FH/FHV/FZ5-series Controller has an alignment function that you can use to position workpieces for stage and robot applications (hereafter called *external devices*).

Alignment executes a combination of more than one processing item.

This section gives an overview of alignment, and provides details on its use in general.

Refer to *Vision System FH/FHV/FZ5 Series Processing Item Function Reference Manual* (Cat. No. Z341) for details on the processing items that are used for alignment.

## 10-9-1 Overview

An FH/FHV/FZ5-series Controller measures the position of alignment marks on the workpiece, or the position of specific features of the workpiece (such as corners), and outputs the axis movement to a PLC or stage controller, which aligns the workpiece into a specified position (hereafter called the *reference position*).

The PLC or stage controller simply needs to send a movement command to the external device for the axis movement amount that was output from the FH/FHV/FZ5-series Controller to align the position of the workpiece.

The following two measurement flows are used to perform alignment. Set both flows for each scene.

- Calibration flow  
This flow associates the coordinates of the external device with the Camera coordinates.
- Alignment flow  
This flow uses the calibration parameters that were created in the calibration flow to align the position of the workpiece.

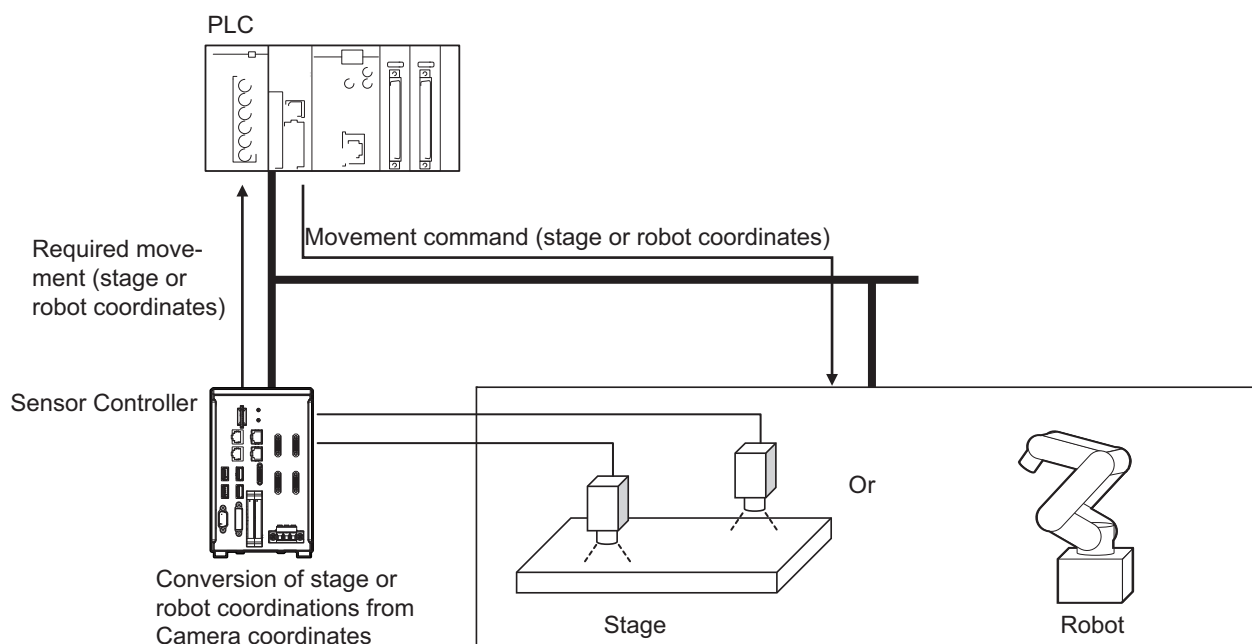

## Supported External Devices

Alignment is supported for the following external devices.

		Type	
Stages	X $\theta$	$\theta$ axis: Direct drive	Camera axis movement: None
			Camera axis movement: X axis
	$\theta$ axis: Linear drive	Camera axis movement: None	
		Camera axis movement: X axis	
	Y $\theta$	$\theta$ axis: Direct drive	Camera axis movement: None
			Camera axis movement: Y axis
	$\theta$ axis: Linear drive	Camera axis movement: None	
		Camera axis movement: Y axis	
	$\theta$ X	$\theta$ axis: Direct drive	Camera axis movement: None
			Camera axis movement: X axis
	$\theta$ axis: Linear drive	Camera axis movement: None	
		Camera axis movement: X axis	
	$\theta$ Y	$\theta$ axis: Direct drive	Camera axis movement: None
			Camera axis movement: Y axis
	$\theta$ axis: Linear drive	Camera axis movement: None	
		Camera axis movement: Y axis	
	XY		
	XY $\theta$	$\theta$ axis: Direct drive	Camera axis movement: None
			Camera axis movement: X axis
	$\theta$ axis: Linear drive	Camera axis movement: Y axis	
		Camera axis movement: XY axes	
	$\theta$ XY	$\theta$ axis: Direct drive	Camera axis movement: None
			Camera axis movement: X axis
	$\theta$ axis: Linear drive	Camera axis movement: Y axis	
Camera axis movement: XY axes			
UVW	Direct fulcrum motion	Camera axis movement: None	
		Camera axis movement: X axis	
UVWR	Rotary fulcrum motion	Camera axis movement: Y axis	
		Camera axis movement: XY axes	
Robots	3 axes	Control method: Fixed positions	
		Control method: Measured positions	

## Using Alignment

### ● Calibration

The Camera and external device both have their own coordinates, so it is necessary to calculate the relationship of the coordinates of the Camera and the external device in advance. This process is called *calibration*.

The FH/FHV/FZ5-series Controller uses the external device to move the workpiece and measure it. This is repeated to calculate the calibration parameter.

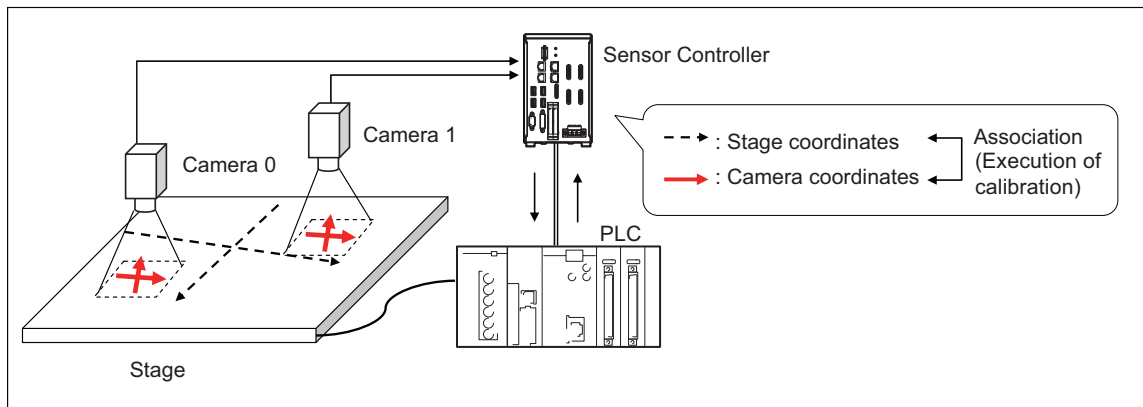

### ● Alignment: Aligning the Position of the Workpiece

The image taken by the Camera is used to measure the position of alignment marks on the workpiece, or the position of specific features of the workpiece (such as corners) in Camera coordinates (pixels). The calibration parameter that is calculated in the calibration flow is used to convert the measured position into the coordinates of the external device. Finally, the axis movement that is required to match the measured position to the reference position angle is calculated and output to the external device.

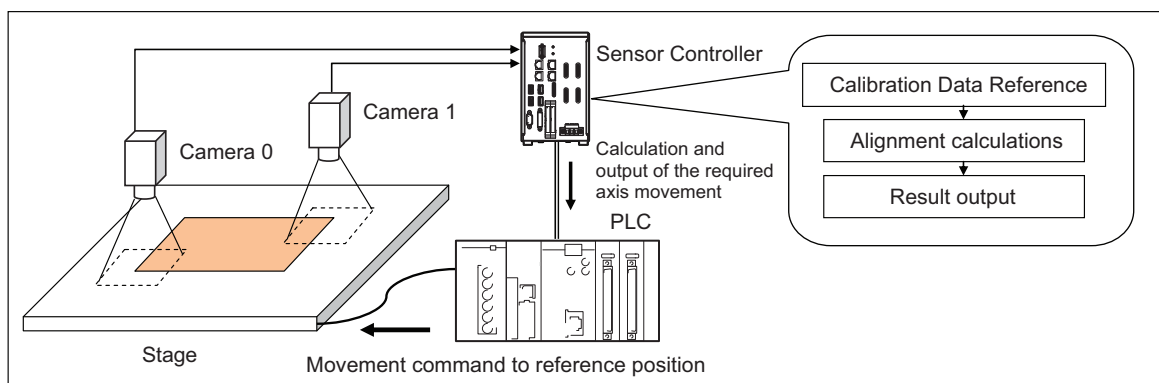

## 10-9-2 Execution of Calibration

This section uses two Cameras and a stage as the external device to describe an example for setting the calibration flow and executing calibration.

Example: Calibration Flow Example for 2 Cameras

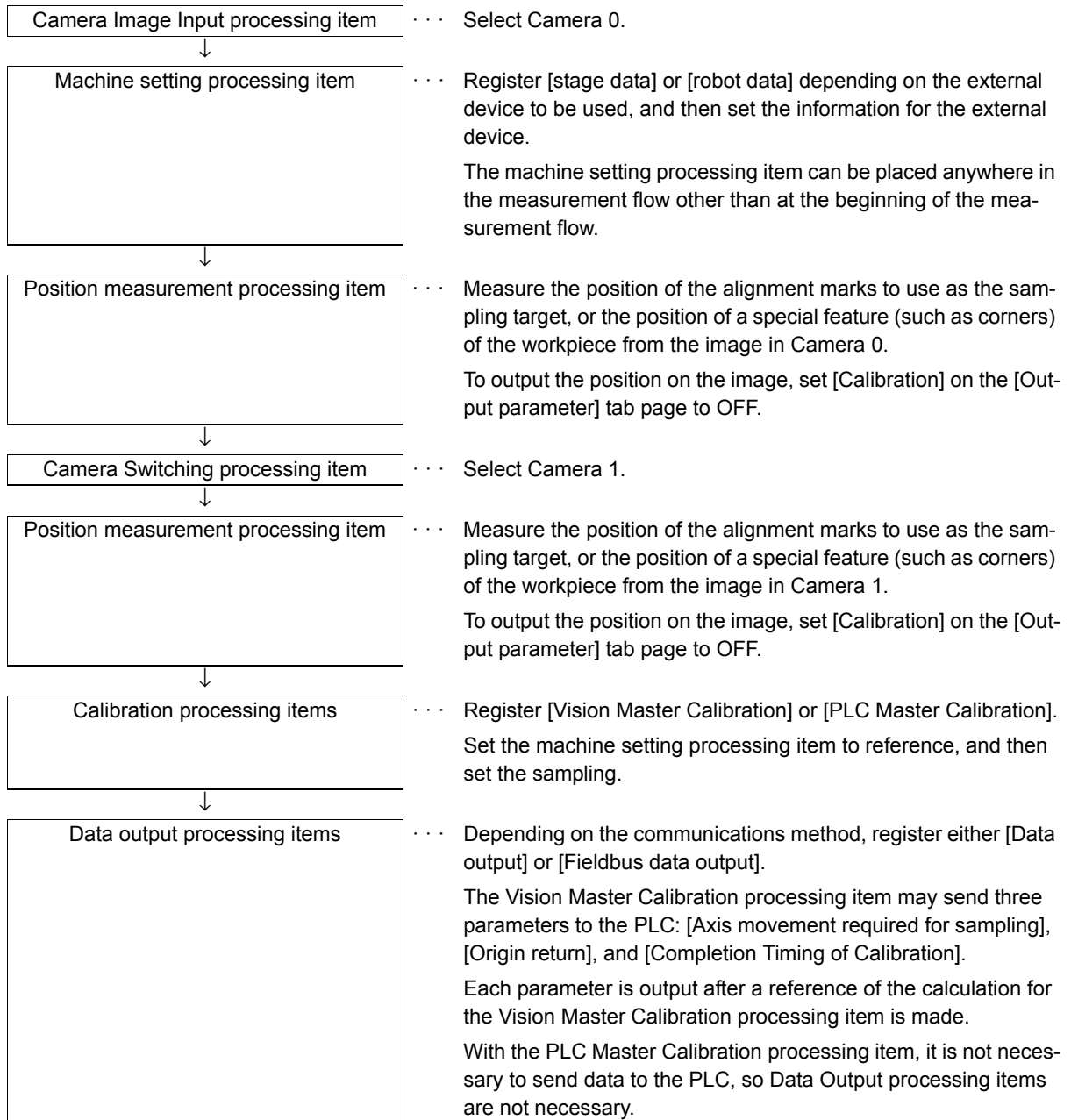

## Settings for the External Device to Use

---

Set the parameters that describe the type and specifications of the external device to use.

Add the following machine setting processing item to the flow.

### ● Stage Data

If you are using a stage, use this processing item.

Refer to *Stage Data* of the *Vision System FH/FHV/FZ5 Series Processing Item Function Reference Manual* (Cat. No. Z341).

### ● Robot Data

If you are using a robot, use this processing item.

Refer to *Robot Data* of the *Vision System FH/FHV/FZ5 Series Processing Item Function Reference Manual* (Cat. No. Z341).

The settings for the machine setting processing item can be referenced by the following processing items.

- Vision Master Calibration
- PLC Master Calibration
- Transfer Position Data
- Calc Axis Move
- Calc Axis Move by Multipoint



### Additional Information

---

The settings for the machine setting processing item can be referenced from other scenes.

The machine setting processing item can be registered only in one scene group, but it can be referenced from other the scenes. This enables central management of the external device settings.

---

## Settings for the Calibration To Execute

---

Add the following Calibration processing items to the flow.

### ● Vision Master Calibration

This processing item calculates the axis movement that is necessary to perform the most accurate calibration within the range of movement of the external device.

This routine is performed repeatedly to create very precise calibration parameters: Output the calculated axis movement to the PLC, the PLC moves the external device, the PLC sends a measurement command to the FH/FHV/FZ5-series Controller.

Reference the Calibration Data Reference processing item to access the calibration parameters that were created.

Refer to *Vision Master Calibration* of the *Vision System FH/FHV/FZ5 Series Processing Item Function Reference Manual* (Cat. No. Z341).



#### Important

---

If you are using the measurement results of the Sensor Controller to operate an external device, make sure the movement is within the range of the movement of the external device before you implement the move.

---



#### Additional Information

---

The Vision Master Calibration processing item has the following advantages over PLC Master Calibration processing item.

- There is no need for trial and error with the order of movements or axis movement, even with complicated external devices, such as UVW stages.  
The order of movement of the workpiece during calibration and the axis movement of the external device that corresponds to each movement are automatically calculated.
  - Even if you change the calibration conditions, you do not have to change the PLC ladder programming.  
If you add more sampling points for better precision, or if you reduce the number of sampling points to shorten the calibration time, you can still use the ladder programming as is.
  - In conjunction with calibration, you can also calculate the parameters for distortion correction at the same time.  
This allows you to align positions with even greater accuracy without doing any extra work.
- 

### ● PLC Master Calibration

The PLC Master Calibration processing item creates calibration data as follows: The axis movement that is necessary for sampling is calculated in advance. Then, the following routine is repeated: the PLC moves the external device, it sets the axis movement in the FH/FHV/FZ5-series Controller, and then it sends a measurement command to the FH/FHV/FZ5-series Controller.

Reference the *Calibration Data Reference* item to access the calibration data that was created.

Refer to *PLC Master Calibration* of the *Vision System FH/FHV/FZ5 Series Processing Item Function Reference Manual* (Cat. No. Z341).

## Executing Calibration

### ● Vision Master Calibration (Homing operation selection is Enabled.)

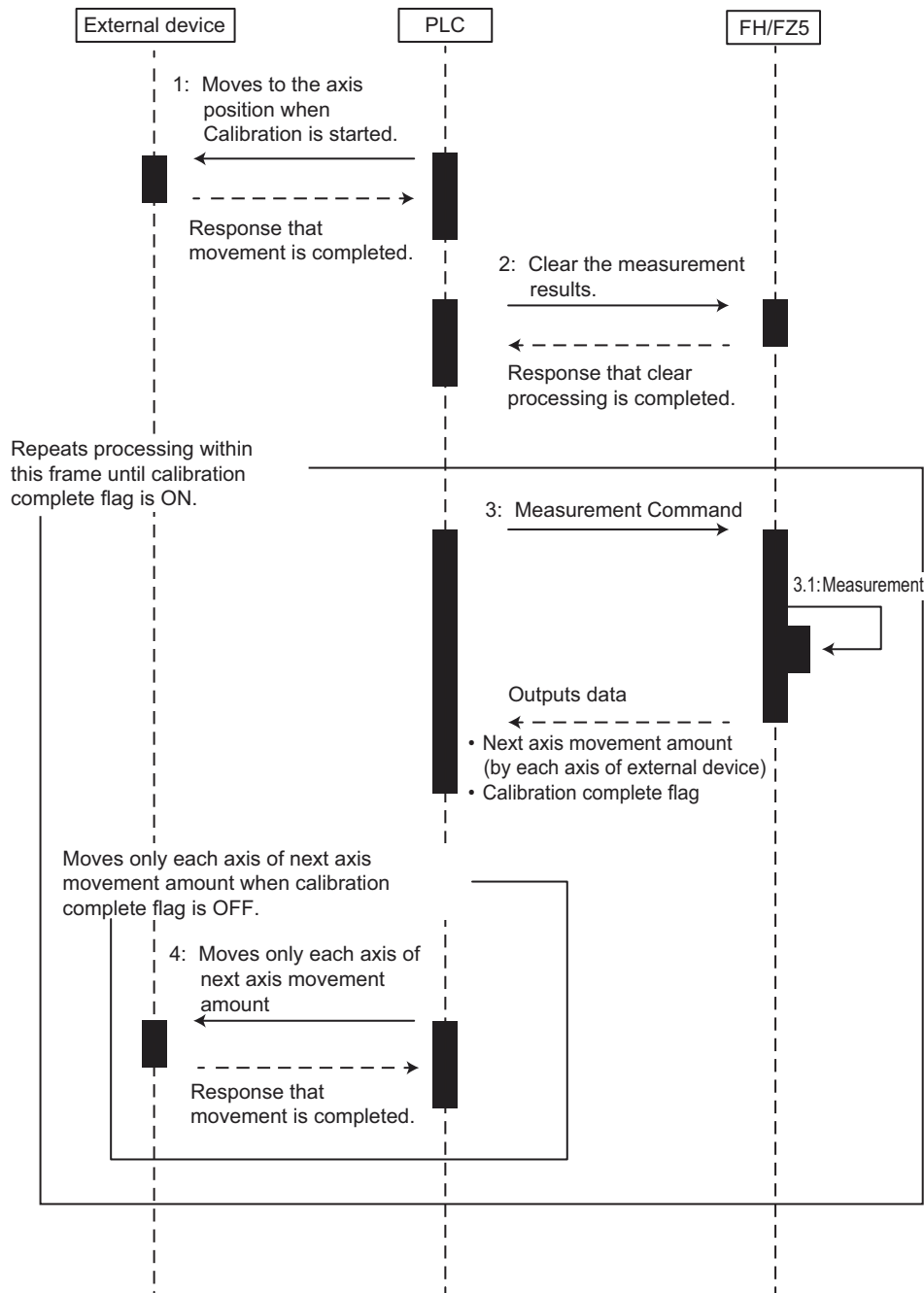

● Vision Master Calibration (Homing operation selection is Disabled.)

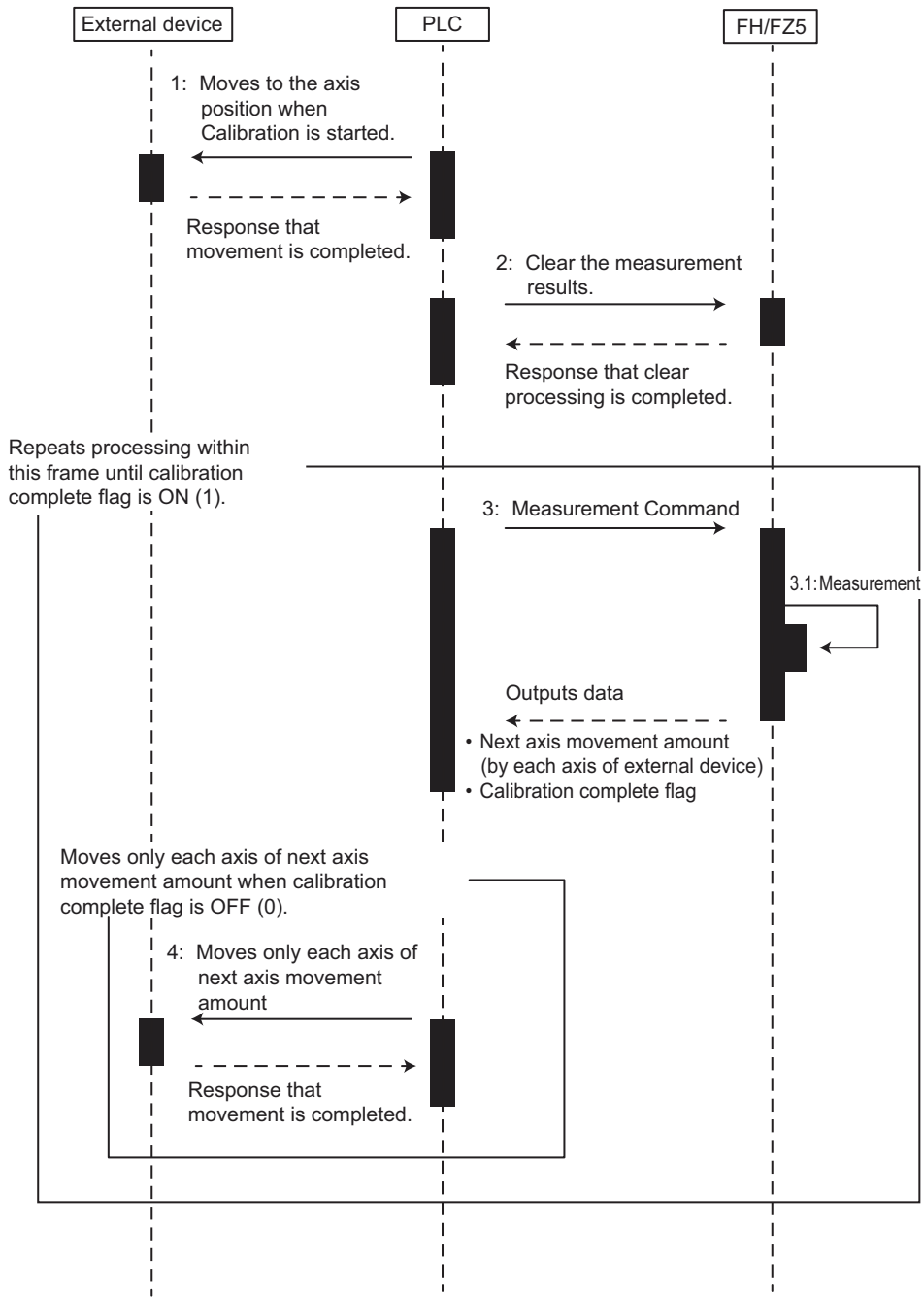



● PLC Master Calibration

- Standard Mode

The numbers in parenthesis are the external reference numbers that are used when commands are executed for the PLC Master Calibration processing unit.

Refer to *External Reference Table* under *PLC Master Calibration* in the *Vision System FH/FHV/FZ5 Series Processing Item Function Reference Manual* (Cat. No. Z341).

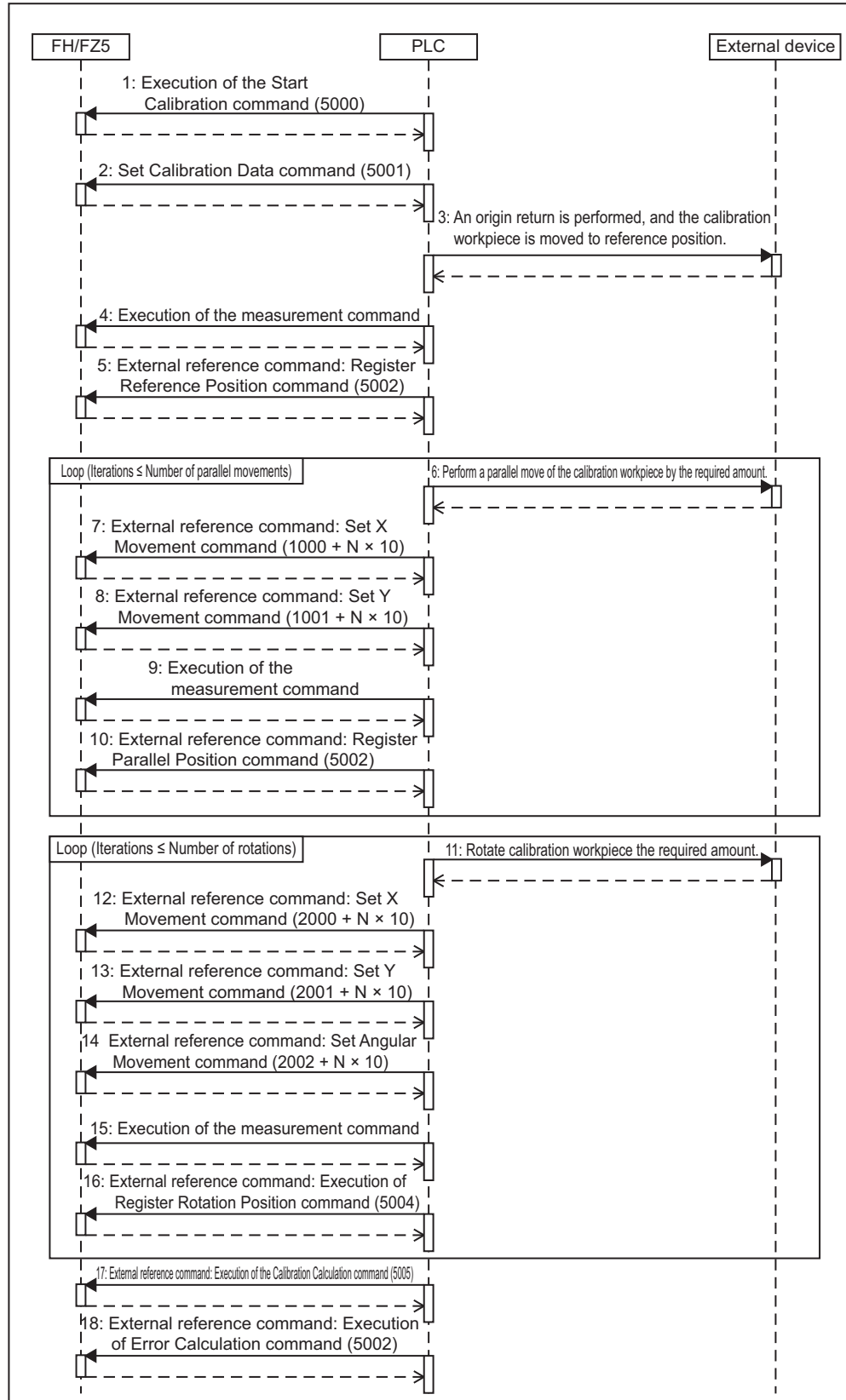

- Easy Mode

The Calibration Execution Flag and movement in actual coordinates must be set in advance in the PLC Master Calibration settings dialog box.

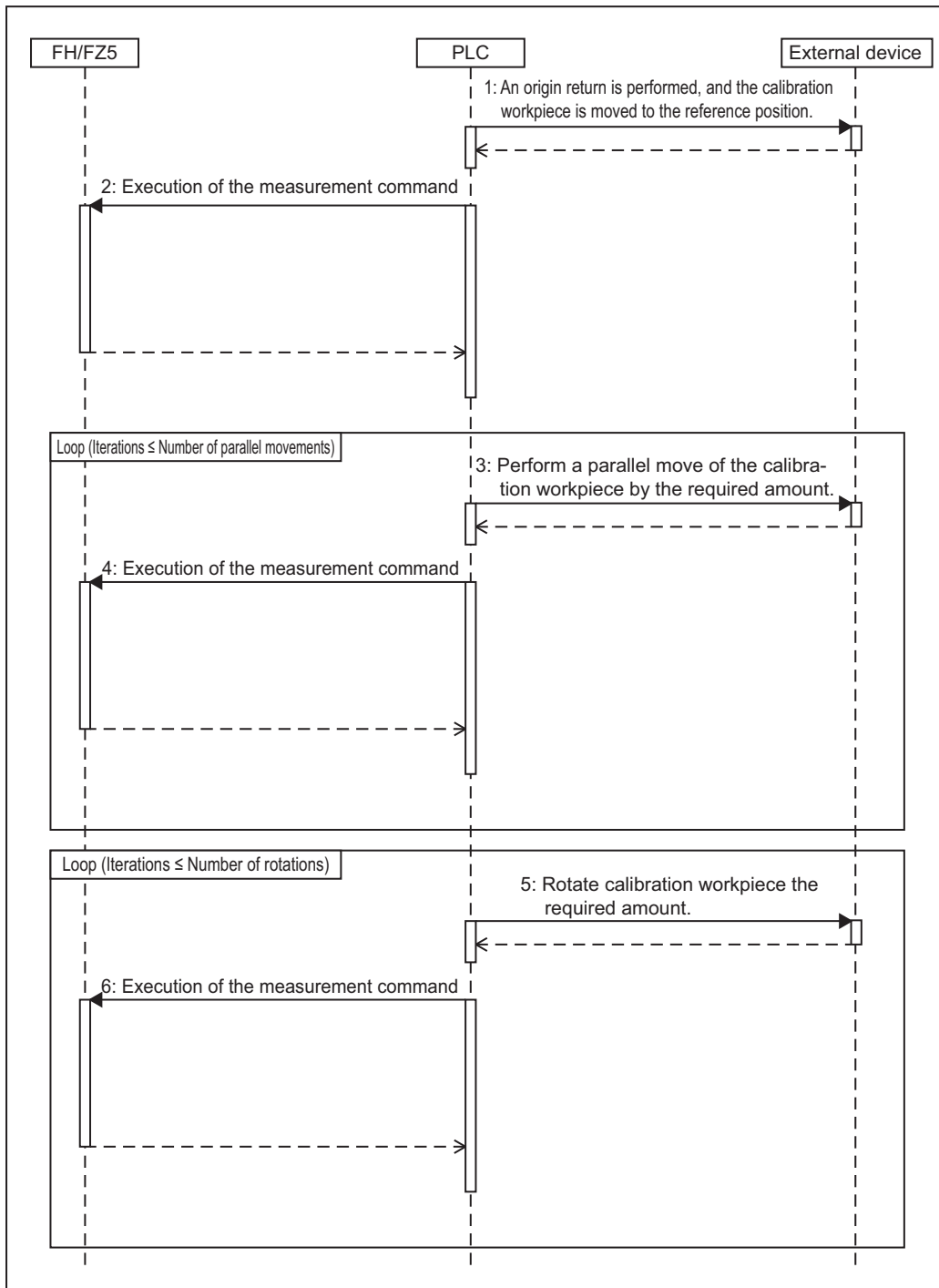

## 10-9-3 Troubleshooting

### PLC Master Calibration

Refer to *Key Points for Adjustment* under *PLC Master Calibration* in the *Vision System FH/FHV/FZ5 Series Processing Item Function Reference Manual* (Cat. No. Z341).

### Vision Master Calibration

Refer to *Key Points for Adjustment* under *Vision Master Calibration* in the *Vision System FH/FHV/FZ5 Series Processing Item Function Reference Manual* (Cat. No. Z341).

### Calibration Support Tool

Symptom	Type	Parameters to adjust	Correction
The unit number is set to [None] and cannot be selected.		---	Check whether there are any processing items that retain calibration data that are registered in the current scene.
The setting data is initialized every time the Toolbox is opened.		<ul style="list-style-type: none"> <li>• Tool Settings Save Button</li> <li>• Tool Settings Load Button</li> </ul>	This is the specified behavior. If you need to save the settings data, use the [Save] button in the Toolbox. The saved settings can be loaded with the [Load] button.
How do you rotate the graphic display for better visibility?		<ul style="list-style-type: none"> <li>• Standard axis</li> <li>• Axis direction</li> <li>• Direction of rotation</li> </ul>	You can rotate the graphic display along the standard axis, axis direction, and rotation direction on the [Display setting] tab page.

## 10-9-4 Alignment

This section will use two Cameras to describe the procedures for setting the alignment flow and executing alignment.

Example 1: Alignment Flow Example (Position Data Calculation and Axis Movement Conversion) for Two Cameras

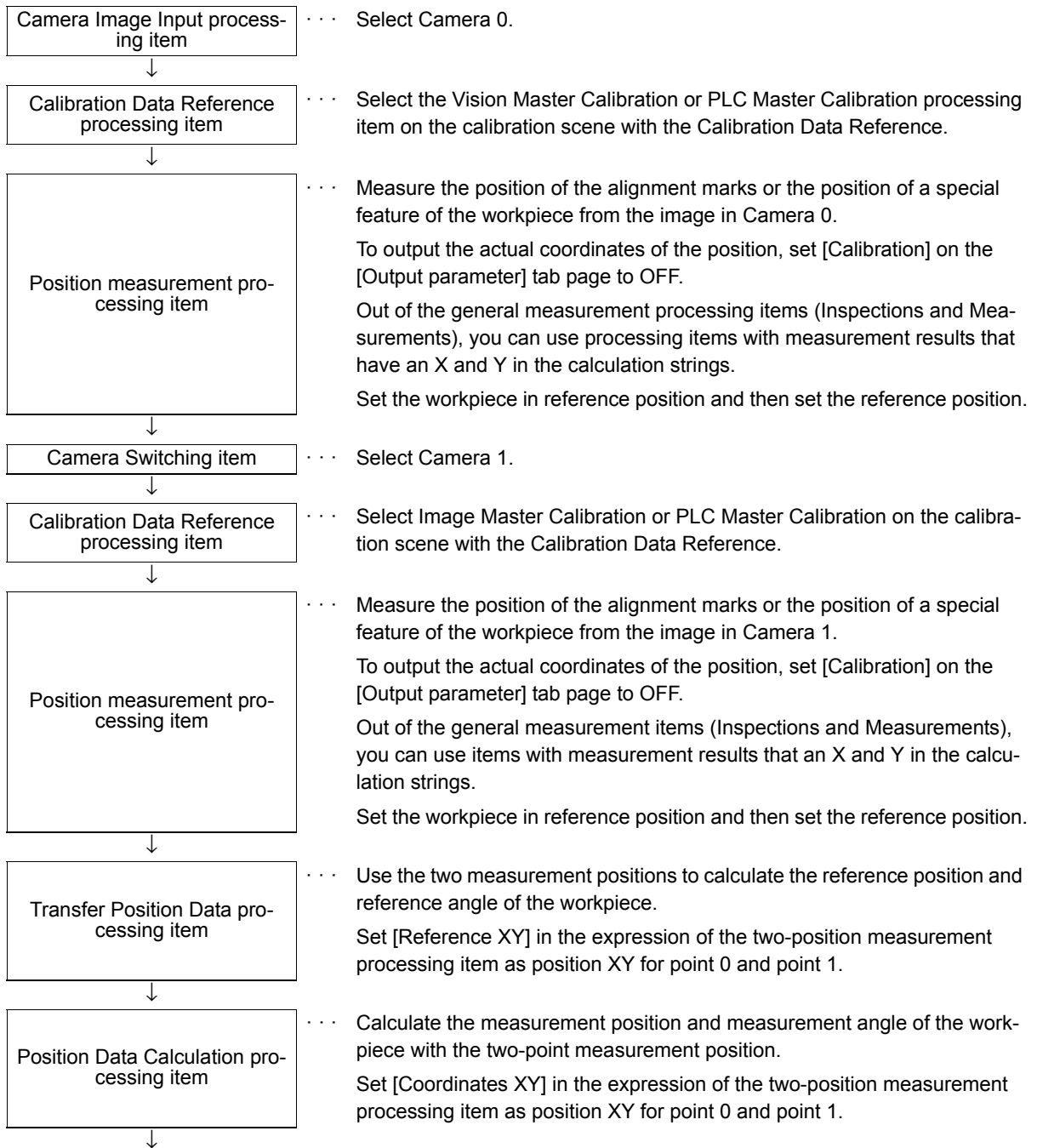

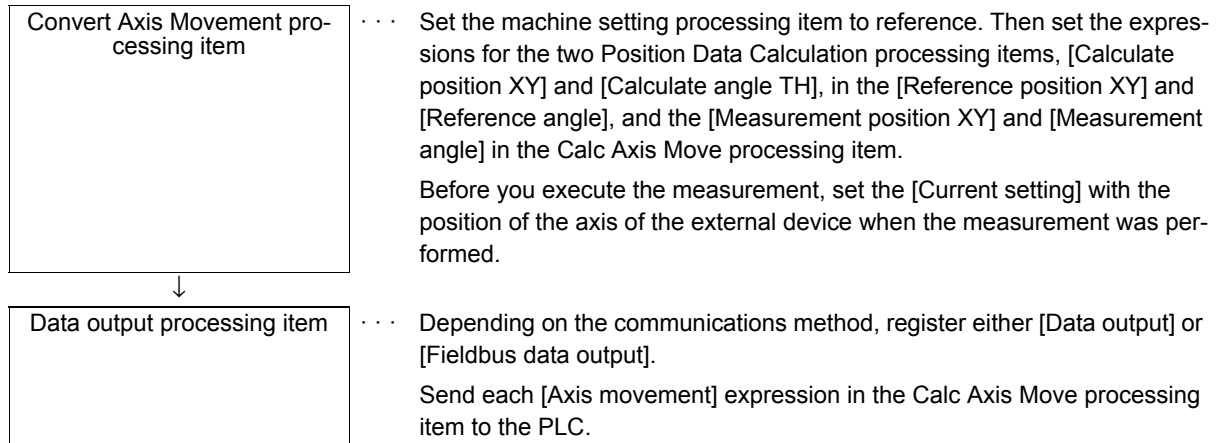

Example 2: Alignment Flow Example (Calc Axis Move by Multipoint) for Two Cameras

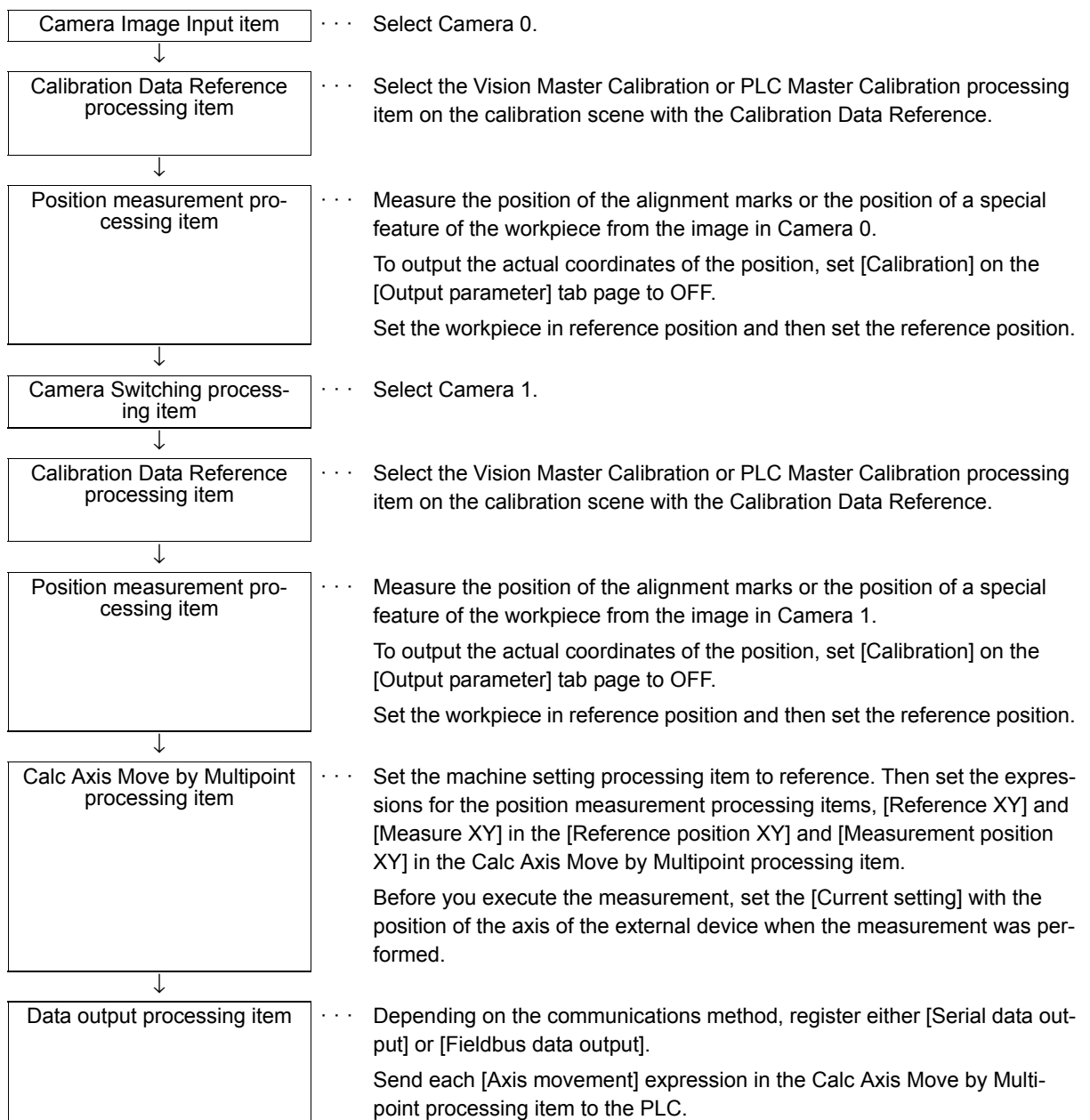

## Settings for Position Alignment

### ● Transfer Position Data + Calc Axis Move

Use these settings to align the measured position and measured angle with the reference position and reference angle.

The movement that is required to align each axis of the external device is calculated and output.

Refer to *Transfer Position Data* and *Calc Axis Move* in the *Vision System FH/FHV/FZ5 Series Processing Item Function Reference Manual* (Cat. No. Z341).

### ● Calc Axis Move by Multipoint

Use this setting to align more than one measured position with corresponding reference positions.

The movement that is required to align each axis of the external device is calculated and output.

Refer to *Calc Axis Move by Multipoint* in the *Vision System FH/FHV/FZ5 Series Processing Item Function Reference Manual* (Cat. No. Z341).



### Important

If you are using the measurement results of the Sensor Controller to operate an external device, make sure the movement is within the range of the movement of the external device before you implement the move.

### Executing Alignment

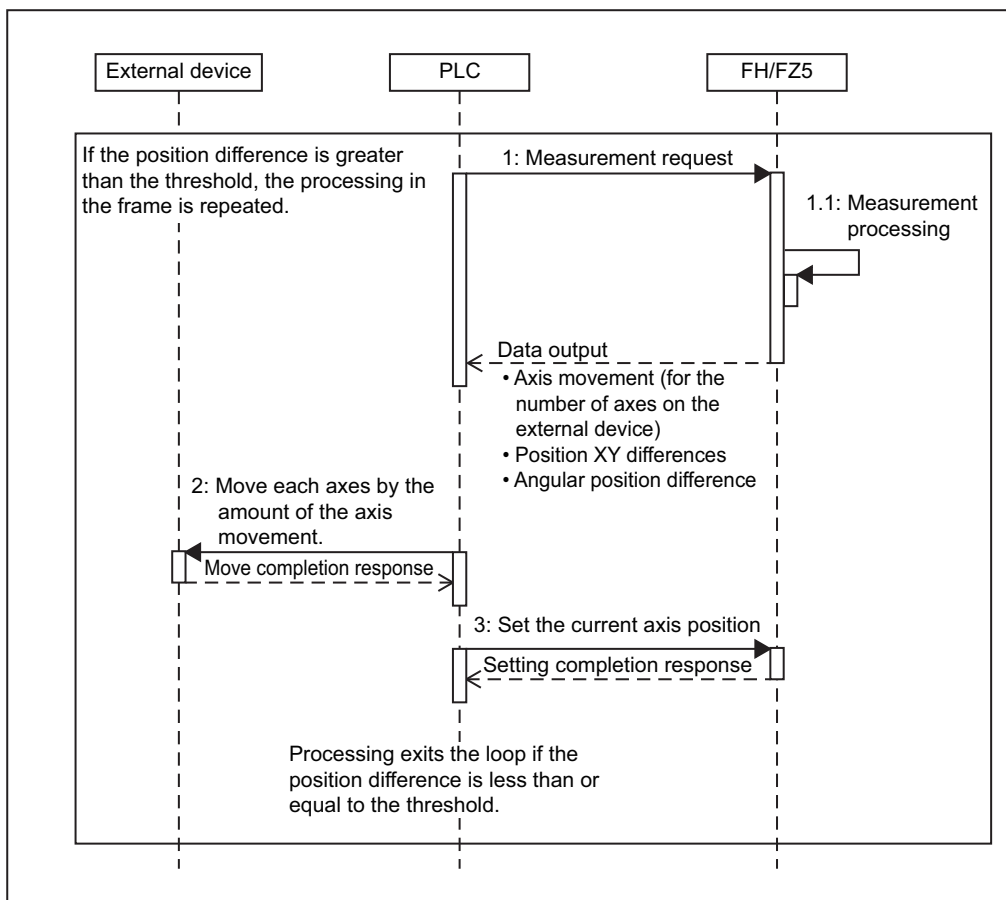

## Other Alignment Functions

- **When failed to measure such as an alignment mark, an operator directly and manually specifies the coordinates.**

When failed to measure such as an alignment mark, an operator can specify the coordinates manually and directly by using the Manual Position Setting processing unit function in combination with a processing unit such as “Search” to detect an alignment mark.

There are two ways to launch the Manual Position Setting function.

- Communication command startup

Higher-level devices such as PLC check a transmitted measurement data from the Sensor controller. If the Position Setting Request flag was set, then the device judge the measurement failed and send a measurement command for re-measurement. The command opens the Manual Position Setting screen.

- Auto startup during measurement

When a judgement result of a processing unit such as “Search” became NG, the Manual Position Setting processing unit opens the Manual Position Setting screen.

Communication command startup:

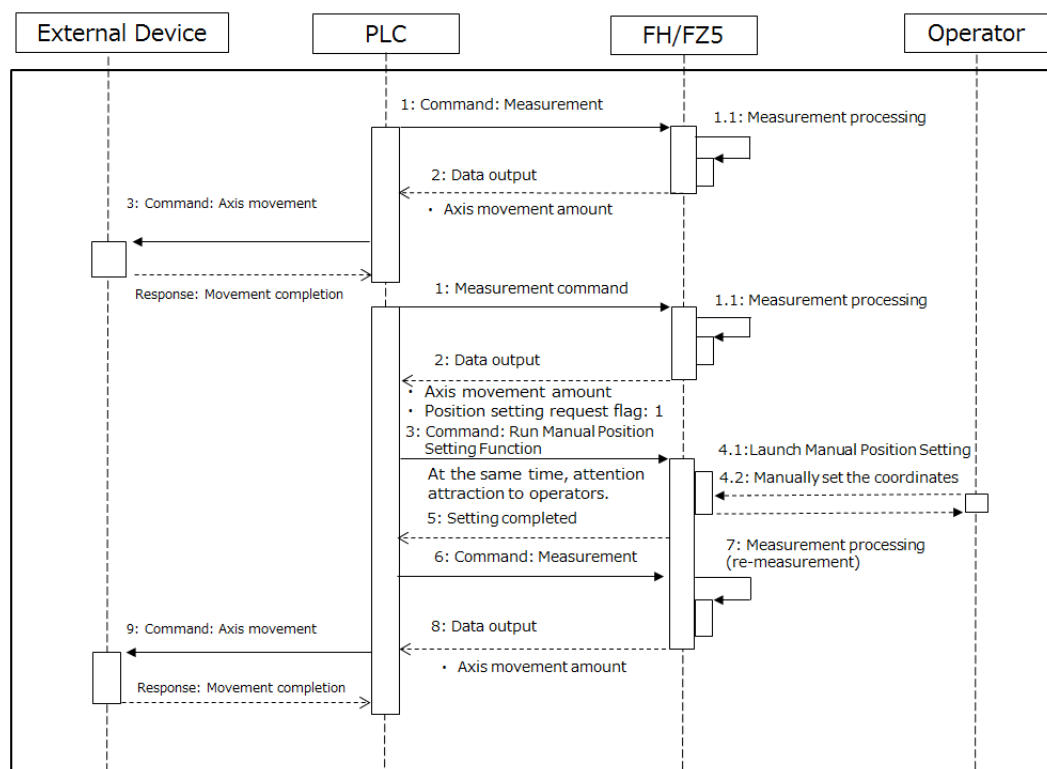

Auto startup during measurement:

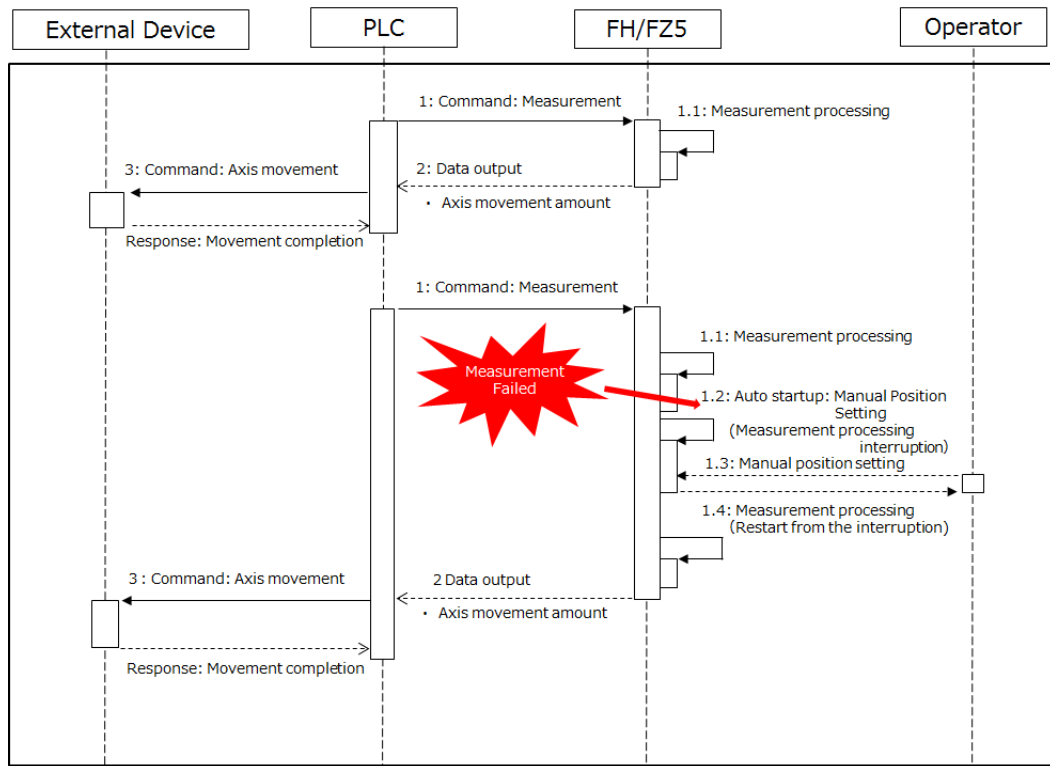

For details about processing items related to the alignment, refer to the *Manual Position Setting* in the *Vision System FH/FHV/FZ5 Series Processing Item Function Reference Manual (Z365)*.



## ● Machine Simulator

The Machine Simulator processing item allows you to see how the alignment marks move on the image while each axes of the stage or robot is being controlled. You can use it to verify the operation of the alignment processing items even if the actual stage or robot is not available. The following example uses two Cameras to describe the use of the Machine Simulator processing item to verify the operation of a Vision Master Calibration processing item.

### Example: Usage Example for Two Cameras

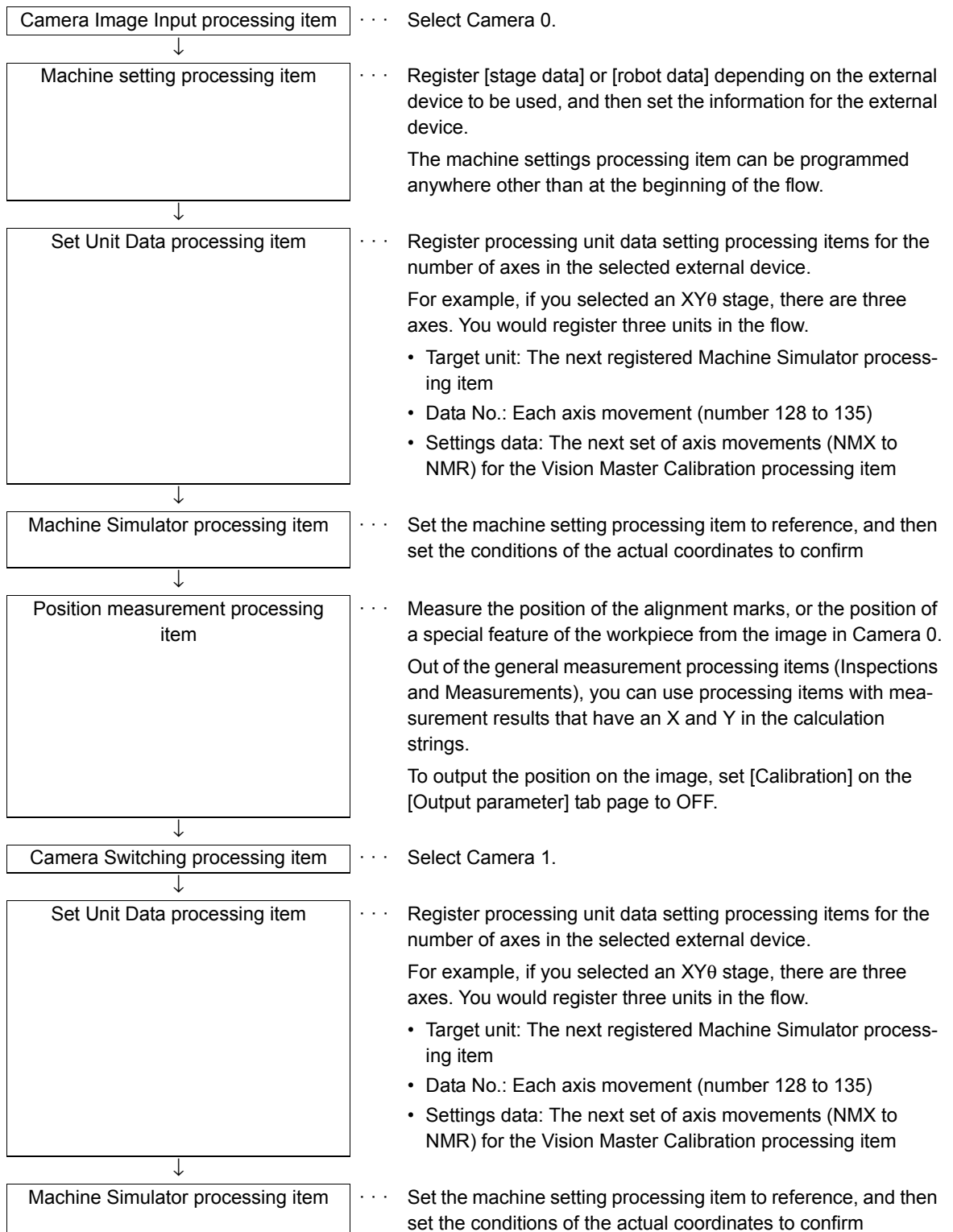

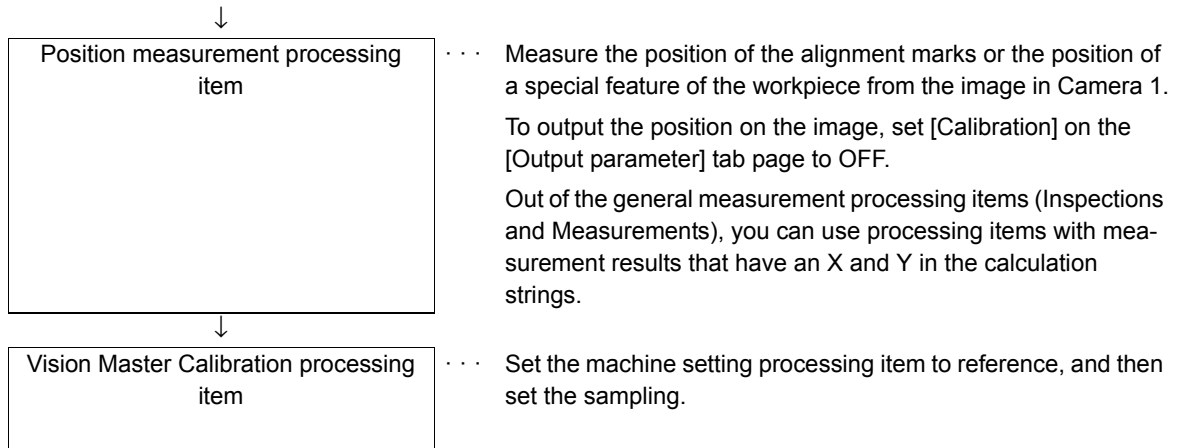

- Using the Flow

The motionless workpiece (or a saved image) is continuously measured until the calibration is completed.

This allows you to easily verify the operation of the calibration flow with the FH/FHV/FZ5-series Controller. Conventionally, you could not verify the calibration flow unless the Controller was integrated into the system.

Refer to *Machine Simulator of the Vision System FH/FHV/FZ5 Series Processing Item Function Reference Manual* (Cat. No. Z341).

### 10-9-5 Alignment Processing Items

The following processing items can be used as alignment processing items.

Refer to the following manual for details on processing items.

Refer to *Vision System FH/FHV/FZ5 Series Processing Item Function Reference Manual* (Cat. No. Z341).

Processing item category	Sub category	Processing item name	Description
Measurement support processing items (Inspection and measurement support items)	Machine setting processing items	Stage Data	This processing item sets and retains data that is related to a stage. Enter the data based on the specifications of the stage to use.
		Robot Data	This processing item sets and retains data that is related to the robot. Enter the data based on the specifications of the robot to use.
	Calibration processing items	Vision Master Calibration	This processing item is specifically for the calibration of the Camera coordinates and external device coordinates. This processing item automatically calculates all axis movements of the external device that are required for calibration. This allows the calibration process to be carried out with greater ease and precision.
		PLC Master Calibration	This processing item is specifically for the calibration of the Camera coordinates and external device coordinates. This processing item allows you to freely set the axis movement of the external device that is required for calibration.
	Calibration Data Reference	Calibration Data Reference	This processing item is used to reference calibration data and distortion data that is stored in other processing items. The referenced data is used to perform coordinate conversion processing and distortion correction on the measurement results that follow this processing item.
	Alignment calculations	Calc Axis Move	This processing item calculates all axis movements of the external device that are required to match the measured position and angle to the reference position and angle.
		Calc Axis Move by Multipoint	This processing item calculates all axis movements of the external device that are required to match the measured position to the reference position. You can set up to eight points each for the measured position and reference position.
		Transfer Position Data	This processing item calculates the position data and angle data after each axis of the external device is moved by a required amount. Use this processing item when you want to move the stage by a required amount, and then perform a measurement to obtain the position data and angle data before the stage was moved.
		Position Data Calculation	This processing item uses the measurement results from more than one processing item to calculate the position data and angle data to be used in a Calc Axis Move processing item.
	Image Correction processing items ([Compensate image])	Scrolling	Machine Simulator



# 11

## What to Do!

---



<b>11-1 Error Messages and Troubleshooting</b> .....	<b>11-2</b>
<b>11-2 FAQ</b> .....	<b>11-9</b>
11-2-1 During Start-up .....	11-9
11-2-2 During Operation .....	11-10
11-2-3 For Measurement .....	11-11
11-2-4 About Parallel Interface .....	11-12
11-2-5 Serial Interface (RS-232C/422 Connection) .....	11-13
11-2-6 Camera with Lighting Controller .....	11-14

# 11-1 Error Messages and Troubleshooting

This section lists error messages that are displayed on the screen and the solutions for them.



 ERR When a message with this symbol is displayed, the ERROR signal on the parallel interface is on.

Error message	Troubleshooting
No value set. Be sure to set up value.	A value must be set for this item. Please set up value.
<ul style="list-style-type: none"> <li>Invalid system disk Replace the disk, and then press any key.</li> <li>Remove disks or other media. Press any key to restart.</li> </ul>	An error occurred in USB memory. End the Controller and turn OFF the power supply. Then back up the data from the USB memory device that you removed from the Controller and then physically format it on your computer with a physical formatting tool. If the problem cannot be solved by physically reformatting the USB memory device, it may be damaged.
Error of the expression.	Do the following errors exist in settings for an expression set up? <ul style="list-style-type: none"> <li>Different number of open/close parentheses</li> <li>TJG/unit/value/function/operator/comma is lined next to each other.</li> <li>Operator is set at beginning or end of expression</li> <li>The number of function operands is insufficient or there are more than is needed</li> </ul>
Cannot add object. Out of range of specified characters of expression.	Incompliant to the conditions of expression. Please check the content. Refer to <i>Calculation-Settings (Calculation)</i> in the <i>Vision System FH/FHV/FZ5 Series Processing Item Function Reference Manual</i> (Cat. No. Z341).
The problem occurred in the camera connection.   ERR	Is the camera cable connected to the controller? Is camera cable disconnected? Do [Select camera] of [Camera Image Input] and [Camera Switching] have any errors? Do you perform camera switching when an image has not been input? Please check the contents of [Camera setting], then switch off and restart. Refer to <i>Camera Image Input-Camera Settings</i> in the <i>Vision System FH/FHV/FZ5 Series Processing Item Function Reference Manual</i> (Cat. No. Z341).
Failed to start the window. Memory is insufficient.	Because memory available for use was insufficient, memory needed to open the window could not be secured. Check the flow by adjusting the measurement region of each processing unit and the sizes of the registered models. <ul style="list-style-type: none"> <li>When doing Image logging, if the RAMDisk has insufficient capacity, a warning message will appear when opening the Setup window for the selected Processing item. To save an image logging file to RAMDisk, re-open the setup window after increasing the RAMDisk free space by moving data to the USB-Disk.</li> </ul>

Error message	Troubleshooting
<p>Loading the startup Scene group failed. No read location found. Try one of the following:</p> <ul style="list-style-type: none"> <li>• When reading from an external storage device, verify connection to the external memory device and press OK button to do load operation.</li> <li>• To change the Startup scene group, select Change startup scene.</li> <li>• If there is no external storage device attached, or no Startup scene group set, in the Scene group saving destination settings, select Save all scene group data in the flash memory.</li> </ul>	<p>Here are some things to consider. Choose a remedy noting the messages.</p> <ul style="list-style-type: none"> <li>• No read location for the Scene group</li> <li>• The external storage device containing the Scene group is corrupted.</li> <li>• The Scene group data is corrupted.</li> <li>• You have selected a non-existing Scene group.</li> </ul> <p>Moreover, when this error message is displayed even though external storage has been connected, a recognition delay of external storage happens at start-up of the Sensor Controller and loading scene group data from the external storage may have failed. Refer to <i>3-6-2 Device Information Storage Tool</i> on page 3-35.</p>
<p>Warning range shall be set within the range from judgement lower to upper limit.</p>	<p>Please redefine the upper and lower warning range limits such that they are within the range between the lower and upper evaluation limits.</p> <p>Refer to <i>Trend Monitor-Judgement Conditions (Trend Monitor)</i> in the <i>Vision System FH/FHV/FZ5 Series Processing Item Function Reference Manual</i> (Cat. No. Z341).</p>
<p>The "Search" measurement result may be "NG (Insufficient memory)" with the current setting.</p>	<p>Insufficient memory may occur during measurement.</p> <p>Reset the model parameters.</p> <ul style="list-style-type: none"> <li>• [Search] Refer to <i>Search - Judgement is NG (Insufficient Memory)</i> in the <i>Vision System FH/FHV/FZ5 Series Processing Item Function Reference Manual</i> (Cat. No. Z341).</li> <li>• [Flexible search] Refer to <i>Flexible search - Judgement is NG (Insufficient Memory)</i> in the <i>Vision System FH/FHV/FZ5 Series Processing Item Function Reference Manual</i> (Cat. No. Z341).</li> <li>• [Classification] Refer to <i>Classification - Judgement is NG (Insufficient Memory)</i> in the <i>Vision System FH/FHV/FZ5 Series Processing Item Function Reference Manual</i> (Cat. No. Z341).</li> </ul>
<p>Save operation failed due to insufficient flash memory space in the Sensor Controller. The current Scene group data in Sensor Controller memory will be discarded after system reboot.</p>	<ul style="list-style-type: none"> <li>• Increase the free memory space then re-try saving to the Sensor Controller.</li> <li>• Delete Scene, or Processing unit, or try adjusting the Measurement region of the Processing unit, or the size of the registered model.</li> <li>• Set the Save destination for the Scene group data to be an external storage device. Refer to <i>7-5 Saving Scene Groups in External Storage [Scene Group Saving Destination Settings]</i> on page 7-10.</li> <li>• Save the current Scene group data to external storage. Refer to <i>9-3 Saving Setting Data to the Controller RAMDisk or an External Storage Device</i> on page 9-8.</li> </ul>
<p>The problem occurred in the system.</p> <p> ERR</p>	<p>This is displayed when the significant abnormality occurs in the controller system. Please contact one of our branches or regional offices.</p>
<p>The problem occurred in system date. The system battery is insufficient.</p> <p> ERR</p>	<p>Low battery (for the backup of date and time data) level. The batteries need to be replaced. Please return old batteries to one of our branches or regional offices.</p>
<p>Failed to switch scene.</p>	<p>Is a USBDisk set to the controller? A USBDisk is needed to read scenes after scene group 1.</p>

Error message	Troubleshooting
Failed to switch scene group or save scene group on switch.	The cause of the failure to switch or to save when switching may be that the USBDisk was removed from the controller. Set a USBDisk to the controller and try again.
Failed to clear scene group.	Confirm that a USBDisk is set to the controller and try again.
Failed to load Scene group. Data is corrupted, or memory is insufficient. Scene group data starts with initialized status.	The following causes are suspected: <ul style="list-style-type: none"> <li>• The power may have been cut off during the last data save.</li> <li>• Because the Operation mode was switched, the required memory size may have increased and memory became insufficient.</li> </ul>
Lighting connection has a problem.	Check the following points. <ul style="list-style-type: none"> <li>• Is there a light with a power consumption higher than 7.5 W connected without an external power supply?</li> <li>• Is there a light with a power consumption higher than 15 W connected with an external power supply?</li> </ul>
Processing units can not be add. Refer to the followings: <ul style="list-style-type: none"> <li>• Unusable processing item is selected.</li> <li>• Insufficient memory.</li> </ul>	Make sure whether non-supported Processing items were added to the Scene. <ul style="list-style-type: none"> <li>• You cannot add [Camera Image Input] processing item to the FH series Sensor Controller. The remaining usable memory is insufficient for adding the Processing item. Re-create the flow after adjusting the size of registered models or measurement regions for each processing unit to use less memory.</li> </ul>
The camera connected is not the same as the one used for the last save. Please check.	<ul style="list-style-type: none"> <li>• Check if the camera is connected correctly. This message is displayed when the system and the scene group 0 data edited using the simulation software are loaded and the unit is restarted. Save the setting to the controller and then restart.</li> <li>• The camera type has been changed from FZ-SC5M2/FZ-S5M2 type to FZ-SC5M3/FZ-S5M3 type, therefore the scene data has been converted. Verify the input image and adjust settings as needed. Refer to Camera Image Input FH, Camera Image Input HDR, or Camera Image Input sections of the Vision System FH/FHV/FZ5 Series Processing Item Function Reference Manual (Cat. No. Z341).</li> </ul>
Cannot read selected file. Confirm selected file once again.	Check the following points. <ul style="list-style-type: none"> <li>• Have you removed the USBDisk from the controller after selecting files on the USBDisk?</li> <li>• Have you deleted the selected file? (Such as the case when you selected a file on the RAMDisk and the file was deleted via FTP.)</li> </ul> In addition, the selected file may be corrupt. <ul style="list-style-type: none"> <li>• If the OS environment in which the file was created differs from the OS environment in which the file is being read, it is possible that file capacity limitations have been exceeded. For example, in cases where a large file is created in the PC Simulation Tool, it could exceed the file capacity limitations of the FH/FHV/FZ5 series Sensor Controller and not be readable.</li> </ul>



Error message	Troubleshooting
<p>The communication time-out is occurred.</p> <p> ERR</p>	<p>Switch off controller, verify the following contents and then restart.</p> <ul style="list-style-type: none"> <li>• Is cable connected correctly?</li> <li>• Does it comply with communication specifications of external devices?</li> <li>• Are external devices functioning normally?</li> </ul> <p>If error is not resolved after confirmation, the controller may be damaged. Please discuss this with one of our branches or regional offices.</p> <p>Refer to <i>Non-procedure Communications - Communications Specifications Settings</i> in the <i>Vision System FH/FHV/FZ5 Series User's Manual for Communications Settings</i> (Cat. No. Z342).</p>
<p>Failed to transfer data.</p> <p>The free capacity of RAMDisk may insufficient.</p> <p>Increase the free capacity of RAMDisk and then perform this operation again.</p>	<p>Clean up the content of RAMDisk to increase free space.</p> <p>If this error occurs even though enough free space is available, scene group data may be too large. Review the inspection flow.</p>
<p>Do you want to scan and fix Removable Disk (*:)?</p> <p>There might be a problem with some files on this device or disc. This can happen if you remove the device or disc before all files have been written to it.</p>	<p>The external storage which is inserted to the driver is possible to be abnormal.</p> <p>Select [Continue without scanning], confirm the external storage of your personal computer.</p>
<p>Error in input range. Please input using the correct range.</p>	<p>Please verify range for setting and set up again.</p>
<p>File name contains invalid character.</p>	<p>Please confirm that characters such as \ / , ; * ? " &lt; &gt;   &amp; . SPC (space) are not included in the file name.</p>
<p>Failed to save file. Please check.</p>	<p>Check the following points.</p> <ul style="list-style-type: none"> <li>• Is the memory of the save destination sufficient?</li> <li>• For cases where the save destination is the folder in the USB-Disk, is the USBDisk connected to the controller? Or, the controller may not have detected the USBDisk.</li> </ul>
<p>Fan/voltage error.</p> <p> ERR</p>	<p>Switch off controller, and verify if fan is affected. If error message is still shown after restart, the controller may be damaged. Please contact one of our branches or regional offices.</p>
<p>The error concerning parallel interface was detected. Turn OFF the power and check the connection state of the parallel interface.</p>	<p>Turn off the power, and then confirm the following points of parallel interface communication.</p> <ul style="list-style-type: none"> <li>• Is the parallel interface output directly connected to the power or GND?</li> <li>• The reason why current load is exceeded because the resistive load value of the connected parallel interface is low.</li> </ul>
<p>Procltem error</p> <p>xxxx: xxxxerror</p>	<p>This is displayed when the application software detects an abnormality.</p> <p>Please contact one of our branches or regional offices as there may be a software trouble.</p>

Error message	Troubleshooting
<p>Failed to paste. Please check the save source or the save destination.</p>	<ul style="list-style-type: none"> <li>• No more Scene can be added due to lack of memory.*<sup>1</sup> Review the inspection flow and reduce the memory consumption or switch to another scene group.</li> <li>*1. The display varies depending on the controller. The remaining capacity of the application is not sufficient for the FH series/FZ5-800/1100/1200 series. The remaining data memory capacity is not sufficient for the FZ5-L series/FZ5-600 series.</li> <li>• The amount of memory used and free data memory can be checked from the menu of Memory Consumption Monitor on the Measurement Management Bar or the system menu. Refer to 3-4 <i>Checking the Memory Consumption and Percentage of Memory Used</i> on page 3-31 and 3-3 <i>Checking System Information</i> on page 3-27.</li> </ul>
<p>A camera outside the guarantee is connected.</p>	<p>A camera outside the guarantee is connected to the controller currently being used.</p>
<p>Destination folder is not found. Please check.</p>	<p>Check the following points.</p> <ul style="list-style-type: none"> <li>• Have you deleted the destination folder?</li> <li>• For cases where the save destination is the folder in the USB-Disk, is the USBDisk connected to the controller? Or, has the USBDisk been detected?</li> </ul>
<p>Failed to save the scene group data. The current Scene group data in the flash memory is discarded after restarting. Recover or avoid by the following ways.</p>	<ul style="list-style-type: none"> <li>• After increasing free memory in flash by such actions as deleting other Scene data, deleting processing units, or making measurement regions or model sizes as small as possible, re-click "Data Save."</li> <li>• Change the save destination for the Scene group data to the external storage device when the current save destination is set to Sensor Controller. Refer to 7-5 <i>Saving Scene Groups in External Storage [Scene Group Saving Destination Settings]</i> on page 7-10.</li> <li>• If the current Scene group is not saved, saves the current scene group to an external storage device. Refer to 9-3 <i>Saving Setting Data to the Controller RAMDisk or an External Storage Device</i> on page 9-8.</li> <li>• The amount of memory used and free data memory can be checked from the menu of Memory Consumption Monitor on the Measurement Management Bar or the system menu. Refer to 3-4 <i>Checking the Memory Consumption and Percentage of Memory Used</i> on page 3-31 and 3-3 <i>Checking System Information</i> on page 3-27.</li> </ul>
<p>PLC link error  ERR</p>	<p>PLC link cannot be established. Check the following points.</p> <ul style="list-style-type: none"> <li>• Are the FZ communication settings correct? Refer to <i>Communicating with PLC Link - Communications Specifications Settings</i> in <i>Vision System FH/FHV/FZ5 Series User's Manual for Communications Settings</i> (Cat. No. Z342).</li> <li>• Are the PLC communication settings correct?</li> <li>• Is cable connected correctly? Refer to <i>I/O Interface</i> in <i>Vision System FH/FZ5 series Hardware Setup Manual</i> (Cat. No. Z366).</li> </ul>
<p>Failed to register model</p>	<p>For Search, Classification, Flexible search, Shape search II Please register higher-contrast images as models. If the model is registered at full screen size, re-register at a smaller size.</p> <hr/> <p>For Fine matching The two pixels at the edge of the image cannot be registered as the model.</p>

Error message	Troubleshooting
Memory is becoming insufficient. According to the setting, memory shortage may occur.	<p>The free application memory has decreased.</p> <p>Memory may become insufficient, or an error may occur in operation mode switching.</p> <p>Re-configure the inspection flow to reduce memory consumption.</p> <p>The amount of memory used and free data memory can be checked from the menu of Memory Consumption Monitor on the Measurement Management Bar or the system menu.</p> <p>Refer to 3-4 <i>Checking the Memory Consumption and Percentage of Memory Used</i> on page 3-31 and 3-3 <i>Checking System Information</i> on page 3-27.</p>
Overcurrent was detected. Turn OFF the power supply and remove the USB device to restart.	<ul style="list-style-type: none"> <li>• There may be a problem with the USB device. Stop the current process and then turn OFF the Sensor Controller. Remove the USB device and restart the Sensor Controller.</li> <li>• The power consumption of the USB device may exceed the power supply capacity of the Sensor Controller. Stop the current process and then turn OFF the Sensor Controller. Provide power to the USB device by using external power source, i.e. AC adapter. Then try to launch the Sensor Controller.</li> </ul>
You need to format the disk in drive *: before you can use it. Do you want to format it?	<ul style="list-style-type: none"> <li>• The external storage which is inserted to the drive may have an error. Select [Cancel] and check the external storage with your computer.</li> </ul>
Add to unit is failed. Insufficiency memory may be occurred.	<ul style="list-style-type: none"> <li>• Application memory is insufficient, Reduce the number of processing units of measurement flow. When you use FZ5-L / FZ5-600 series, reduce the processing type which is registered to the measurement flow and save the system. After that, restart the system. It may be prevent insufficiency memory.</li> <li>• The amount of memory used and free data memory can be checked from the menu of Memory Consumption Monitor on the Measurement Management Bar or the system menu. Refer to 3-4 <i>Checking the Memory Consumption and Percentage of Memory Used</i> on page 3-31 and 3-3 <i>Checking System Information</i> on page 3-27.</li> </ul>
The free capacity of RAMDisk is insufficient. If nothing is done, measurement cannot be performed correctly. Increase free capacity in RAMDisk.	Clean up the content of RAMDisk to increase free space. If this error occurs even though enough free space is available, Scene group data may be too large. Review the inspection flow.
Region size exceeds. Please narrow region.	There are restrictions as to what can be set up based on the camera and processing items being used. Please adjust the region size so that the region is not too large.
<p>Logging error</p> <p style="text-align: center;"> ERR</p>	<p>Image logging failed due to insufficient memory at the save destination.</p> <p>The error message disappears after 10 s.</p> <ul style="list-style-type: none"> <li>• Delete unneeded files in the save destination or prepare a new USB disk.</li> <li>• Logging fails in a measurement at the Sensor Controller start-up, a recognition delay of external storage might have occurred at the Sensor Controller start-up. Use the Device Information Storage Tool.</li> </ul> <p>If "Use scene name as folder names" is checked in the logging setting, logging error occurs if you use ¥ /.;; *? "&lt;&gt;   as the scene name.</p>

Error message	Troubleshooting
The Logon to Network Server screen is displayed.	<p>The connection was cut off based on the idling / session time set on the network logging destination PC.</p> <p>At the command prompt on the PC, enter the following:</p> <pre>net config server /autodisconnect:-1</pre> <p>Then disable the automatic disconnection setting.</p>

Although an error message such as the following, is not displayed, the ERROR signal and the ERR indicator will turn ON.

Cause	Troubleshooting
The STEP signal was input when the READY signal was turned OFF.	<ul style="list-style-type: none"> <li>• Input the STEP signal after the READY signal turns ON.</li> <li>• Noise is superimposed onto the STEP signal. Keep PLC and FH series / FZ5 series Sensor Controller away from the noise source.</li> </ul>
A non-existing parallel command was entered.	<ul style="list-style-type: none"> <li>• Please enter a correct parallel command.</li> </ul>
<p>The parallel scene group switch command was executed when no USB memory was installed.</p> <p>(FZ5-L series / FZ5-600 series)</p>	<ul style="list-style-type: none"> <li>• Switch the scene group with the USB memory installed.</li> </ul>

## 11-2 FAQ

### 11-2-1 During Start-up

- **POWER LED is not lit**

- Is the power supply connected correctly?
- Is the supply voltage low (24 V DC +10%, -15%)?

- **Nothing is displayed on the monitor**

- Is the monitor ON?
- Is the monitor cable connected correctly?
- Has the monitor failed?
- Is the power capacity enough (LCD monitor)?
- Have you turned off the LCD? If you have, the monitor recovery will occur if you tap on the bottom of the monitor.

- **FH/FHV/FZ5 RUN and ADJUST windows are not displayed.**

Camera connection:

- When the camera connection is checked and initialized during start-up, the system will not start unless there is a response from the camera side. Check if the system starts with the camera cable disconnected.

Data corruption:

- The scene group data and system data saved to the controller have been corrupted.
- In some cases when the power is shut down or the USB memory was removed while accessing the CF card in the controller, such as when data is being saved to the controller, a scene group is being switched and scene group is being saved to or loaded from external storage such as USB memory, the data file may get corrupted. The file needs to be repaired. Please contact OMRON.

- **Monitor images are disordered**

- Are the power supply and cable generating electronic noise?
- Is the monitor cable connected correctly?

- **Input cannot be made**

- Are the cables for input devices (mouse, etc) connected correctly?
- Is the angle too big when tapping is done with the touch pen?
- Camera image does not display/Image is blurry
- Is the lens cap removed?
- Is the camera cable connected correctly?
- Is the lens aperture the maximum or the minimum?
- Is the camera's shutter speed correct?
- Is the lighting method correct?

- **Start-up is slow**

- Was the system connected to a LAN when started?  
If the system is started while connected to a LAN, startup may take a longer time.



### Additional Information

---

When [Touch Panel Monitor (FH-MT12)] is selected from the [Serial (RS-232C/422)] box in the [Communication module select] section under [Startup setting], and if a RS-232C cable and a Touch Panel Monitor are not connected to the Sensor Controller, starting the application takes approximately 30 seconds longer than usual.

---

- **The date and time are abnormal.**

- In the case of the FHV series, do you set the date and time?  
In the FHV series, it is necessary to set the date and time each time it is activated.

## 11-2-2 During Operation

- **Measurement results do not display on the monitor**

- Are windows other than the Main screen (the Edit Flow window, etc.) displayed?
- Are any setting windows open?  
\* A setting window is defined as a window that opens separately such as the Edit Flow window and the Scene Maintenance window.

- **"NG (memory shortage)" is displayed in the "Detail result" area**

- Does the number of specific processing items, such as camera image input, exceed the limit?  
Refer to *A-13 About Limits on the Number of Image Input Processing Items Used* on page A-39.

- **Data cannot be saved**

- The data save may have failed because there was not enough free capacity in the flash memory in the controller. The current scene group data in the controller memory is destroyed after the restart. Immediately perform one of the recovery/avoidance procedures specified below.
  - For example, reduce the memory usage and then save data again to the controller, delete scenes, delete processing units, adjust the processing unit measurement area, or adjust the sizes of registered models.
  - Evacuate the current scene group data to the external memory.  
Click [Function] menu - [Save to file] - [Setting data] - [Scene group data].

- **The window switching speed is slow.**

- When both lines are set to through display in the multi-line random trigger mode, the controller's response time may be slow.

- **Remote Operation Tool operation or operation of tools such as the Communications Command Macro tool is unstable.**

- This can occur when there is not enough free application memory space. To free up application memory space in order to resolve this issue, try deleting processing units to reduce the number of processing units in the measurement flow.  
For FZ5-L series/FZ5-600 series, deleting some of the processing item types registered to the measurement flow and then saving the data to the Sensor Controller directly and restarting the system may work to resolve this issue.

### ● Software keyboard is not displayed

- When the keyboard is connected to the sensor controller, the software keyboard is not displayed. Please input characters with the connected keyboard.  
During remote operation, if the keyboard is connected to the PC on the remote control side, the software keyboard will not be displayed.

### ● The image will not be displayed when remeasuring saved images

- You may be using the through image mode in the image display pane on the used layouts. If you are used the through image mode in the image display pane, the image will not be displayed. Check the image mode for all used and unused image display pane.  
Refer to "Arranging Windows" (Refer to 8-3 *Arranging Windows [Layout Functions]* on page 8-14) and check the image display mode specifications for all 24 image display panes.

## 11-2-3 For Measurement

### ● Display is not updated.

- Measurement is given priority when the STEP signal input interval is short or continuous measurement is being performed. As a result, the measurement results (overall judgment, image, individual judgment in the flow display, detailed results) may not be updated. When continuous measurement ends, the measurement results for the final measurement are displayed.

### ● The measurement NG (image mismatch) error will result when connecting a monochrome camera

- Immediately after performing such operation as starting up the FH series / FZ5 series Sensor Controller, changing scenes, and clearing measurement results, there will be no input image. If you edit the settings or press the OK button in the Properties Dialog Box with no input image, the error will occur at the next measurement.
- If you open the Properties Dialog Box and click the OK button to close the dialog box with no input image, the settings will automatically switch to the factory default settings for the color cameras. If measuring an image input from the monochrome camera with these settings, the error will result due to the mismatching color modes between the camera and the settings.
- To correct the settings after the error occurrence, input the image from the monochrome camera and open the Properties Dialog Boxes for each processing unit. Click the OK button on each screen to exit the screen.

### ● Target figure for the processing unit figure setting has disappeared

- This occurs when image input or image compensation-related units, such as filtering, are set between the processing unit figure setting and the unit to be changed.  
Processing Items List Manual  
Processing Item List > Supporting Inspection and Measurement > Processing Unit Figure Setting  
Refer to the [Important] section of the aforementioned.

### ● Judgement (JG) value is -10

- The judgement will be -10 when there is incompatibility between the scene setting and the input image. Could the image be a color image even though it is loaded to a scene that is set for a monochrome camera? Please check the setting.

### ● Communication takes time

- When you select [Through image], communication will more take time from executing the communication command to completion of it.  
If the communication time will take more time, select [Freeze].
- Confirm the device configuration or communication cycle, i.e. Polling cycle of PLC Link or EtherNet/IP.

## 11-2-4 About Parallel Interface

### ● Trigger signal (input signal) not accepted

- Are the cables connected correctly?
- Is the signal cable disconnected?

You can check the communication status in the Confirmation window.

Refer to *Parallel Communications - Testing Communications* in the *Vision System FH/FHV/FZ5 Series User's Manual for Communications Settings* (Cat. No. Z342)

- Are windows other than the Main screen (the Edit Flow window, etc.) displayed?  
Are there any setting windows open?

\* A setting window is defined as a window that opens separately such as the Edit Flow window and the Scene Maintenance window.

### ● Signals cannot be output to external devices

- Is the trigger signal input?
- Are the cables connected correctly?
- Is the signal cable disconnected?

You can check the communication status in the Confirmation window.

Refer to *Parallel Communications - Testing Communications* in the *Vision System FH/FHV/FZ5 Series User's Manual for Communications Settings* (Cat. No. Z342).

- Is test measurement being performed?

Data cannot be output to external devices during test measurement.

### ● GATE signals are not output

Wiring:

- Are parallel cables wired correctly?

Please check if GATE signals are being recognized by the receiving side (such as the PLC) by turning the GATE signal ON/OFF in the System - Communication - Parallel - Confirmation window.

Output setting:

- Is parallel judgement output or parallel data output set for the scene? Is an expression input for parallel data output?
- GATE signals are not output unless these items are specified.
- Is [Output] set to ON in the layout setup?

Set whether to produce external outputs for each layout.

Timing:

- Are the parallel communication settings (output cycle and output time) set to a length sufficient for the PLC to recognize?
- Could the System - Communication - Parallel output control be set to handshaking or synchronization output?

These settings influence the GATE output timing.

Refer to *Parallel Communications - Time Charts* in the *Vision System FH/FHV/FZ5 Series User's Manual for Communications Settings* (Cat. No. Z342).



## 11-2-5 Serial Interface (RS-232C/422 Connection)

### ● No communication available

- Are the cables connected correctly?
- Are the communication specifications of the external devices compatible with the Sensor Controller?

You can check the communication status in the Confirmation window.

Refer to *Non-procedure Communications - Testing Communications* in the *Vision System FH/FHV/FZ5 Series User's Manual for Communications Settings* (Cat. No. Z342).

### ● The Sensor Controller works fine initially, but there is not response after a while

- Is the buffer memory of the PC full?

Please verify if data can be received correctly based on current settings.

### ● Data cannot be saved

- Are the communication specifications of the external devices compatible with the Sensor Controller?
- Is "Flow control" in communication specifications set to "None"?

To save data, set "Flow control" to "None".

Refer to *Non-procedure Communications - Communications Specifications Settings* in the *Vision System FH/FHV/FZ5 Series User's Manual for Communications Settings* (Cat. No. Z342)



#### Additional Information

---

When [Touch Panel Monitor (FH-MT12)] is selected from the [Serial (RS-232C/422)] box in the [Communication module select] section under [Startup setting], and if a RS-232C cable and a Touch Panel Monitor are not connected to the Sensor Controller, starting the application takes approximately 30 seconds longer than usual.

---

## 11-2-6 Camera with Lighting Controller

### ● The light does not turn ON at all

- Did you disconnect or connect the Lighting Controller or Light while the power supply was ON?
- Are two or more lights connected?

If more than one light is connected, it may not be possible to turn them ON simultaneously depending on the total current consumption of the lights. If necessary, set the brightness to 0 for all of the lights except for the light to turn ON.

Refer to *Camera Image Input*, *Camera Image Input FH*, or *Camera Image Input HDR* in the *Vision System FH/FHV/FZ5 Series Processing Items Reference Manual* (Cat. No. Z341).

- Is the [Screen Adjustment Settings] setting of the Camera Image Input FHV processing item the same as the lighting selection wants to flash?  
Only the lighting selected in [Screen Adjustment Settings] will flash.

### ● The light will not stay ON all the time

- Are two or more lights connected?

If two or more lights are connected, the always-on lighting mode cannot be used for lighting if the total power consumption of the lights is 7.5 W or higher.

### ● The light malfunctions

- Is the sequence for turning ON power correct?

If you are using an external power supply, either turn it ON at the same time as the power supply to the Sensor Controller or turn ON the external power supply first.



# Appendices

A

---

<b>A-1 Menu List</b> .....	<b>A-2</b>
<b>A-2 External Tool List</b> .....	<b>A-5</b>
<b>A-3 FHV series Processing items</b> .....	<b>A-6</b>
<b>A-4 FHV series tools</b> .....	<b>A-9</b>
<b>A-5 Measurement Mechanism</b> .....	<b>A-10</b>
A-5-1 Color Processing Mechanism .....	A-10
A-5-2 Search Processing Mechanism .....	A-11
A-5-3 Edge Detection Measurement .....	A-14
A-5-4 Defect Detection Measurement .....	A-18
A-5-5 Handling Coordinates .....	A-19
<b>A-6 Image file</b> .....	<b>A-20</b>
<b>A-7 About Number of Logging Images</b> .....	<b>A-23</b>
<b>A-8 About Max. Number of Loading Images during Multi-input</b> .....	<b>A-27</b>
<b>A-9 About Memories Usable with FH series/FZ5 series</b> .....	<b>A-29</b>
<b>A-10 Memory Usage Guidance For Processing Items</b> .....	<b>A-30</b>
<b>A-11 Memory Display Image on PLC I/O</b> .....	<b>A-35</b>
<b>A-12 Sharing Data Within the Controller [User Data Tool]</b> .....	<b>A-37</b>
A-12-1 Setting Procedure for User Data .....	A-37
<b>A-13 About Limits on the Number of Image Input Processing Items Used</b> ...	<b>A-39</b>
<b>A-14 Operation log input information list</b> .....	<b>A-40</b>
<b>A-15 Character Code Table</b> .....	<b>A-53</b>
<b>A-16 List for Processing Item Identifier</b> .....	<b>A-54</b>

# A-1 Menu List

The menu for the Main Window is described below.

Main menu	Command	Description	Reference
File	End	Exits the FH/FHV/FZ5 System. After you exit the system, restart the system or turn OFF the power supply.	---
Function	Measure	Executes a test measurement (single or continuous measurement), or a re-measurement.	Refer to 6-1 <i>Executing Test Measurements</i> on page 6-3. Refer to 6-4-1 <i>Remeasuring Saved Images [Remeasurement]</i> on page 6-27.
	Scene switch	This button switches between scene groups and scenes:	Refer to 7-2 <i>Switching the Scene or Scene Group</i> on page 7-4.
	Scene maintenance	Used to copy, delete, and rename scenes and scene groups.	Refer to 7-3 <i>Editing Scenes [Scene Maintenance]</i> on page 7-6. Refer to 7-4 <i>Editing Scene Groups [Scene Maintenance]</i> on page 7-8.
	Edit flow	Used to edit measurement flows.	Refer to 5-5-2 <i>Editing Processing Units in a Scene</i> on page 5-24.
	Switch layout	Changes the layout number to display.	Refer to 8-3-1 <i>Arranging Window Elements (Layout Modification)</i> on page 8-14.
	Clear measurement	Clears the measurement data.	Refer to 6-6-2 <i>Clearing Measurement Results [Measurement Clear]</i> on page 6-41.
	Clear logging image	Clears the images that are logged in the Controller.	Refer to 6-6-3 <i>Clearing Saved Images [Logging Image Clear]</i> on page 6-41.
	Screen capture	Captures the screen that is being displayed.	Refer to 3-5 <i>Capturing Screen Images</i> on page 3-32.
	Saving last logging image	Logs the most recent input images that are being displayed.	Refer to 6-3-1 <i>Logging Measurement Values and Measurement Images [Data Logging/Image Logging]</i> on page 6-8.
	Data save	Saves settings data to the flash memory in the FH/FHV/FZ5.	Refer to 3-6-1 <i>Saving the Setting to the Controller [Data Save]</i> on page 3-34. Refer to <i>Saving/Loading Data (P.9-1)</i> .
	Save to file	Saves the settings data, logged images, and logged data to a file. It also copies files between memory devices.	Refer to <i>Saving/Loading Data (P.9-1)</i> .
	Load from file	Loads a settings file.	
System initialization	Restores the Controller to the default settings.	Refer to 3-7 <i>Initializing the Controller</i> on page 3-39.	
System restart	Restarts the Controller.	Refer to 3-6-3 <i>Restarting the Controller: [System Restart]</i> on page 3-37. Refer to <i>Saving/Loading Data (P.9-1)</i> .	

Main menu	Command	Description	Reference
Function	Transfer data	Transfers (copies) the settings for line 0 to line 1, and then changes to the Non-stop Adjustment Mode.	Refer to <i>Non-stop Adjustment Mode</i> on page 4-25.
	Non-stop data transfer	Transfers (copies) the settings for line 1 to line 0 in Non-stop Adjustment Mode without affecting measurements.	
	Operation log	Saves the operation log of the Controller to a special file.	Refer to <i>10-4-1 Using the Operation Log</i> on page 10-40.
	System information	Displays the Controller's model and software version.	Refer to <i>3-3 Checking System Information</i> on page 3-27.
Tool	TDM Editor	Edits the processing flow using variables.	Refer to <i>5-5 Using Variables to Edit the Flow [TDM Editor]</i> on page 5-14.
	System Settings	Sets settings that are related to the system environment of the Controller. Includes settings such as the startup settings, Camera settings, and communications settings.	Refer to <i>Section 4 Setting the Controller</i> on page 4-1.
	Security settings	Used to set accounts and limit access to the Controller.	Refer to <i>10-3 Limiting User Operations [Security Settings]</i> on page 10-29.
	Scene Group Saving Destination Settings	Changes the location for saving scene group data to the sensor controller's memory or external storage.	Refer to <i>7-5 Saving Scene Groups in External Storage [Scene Group Saving Destination Settings]</i> on page 7-10.
	NG analyzer	Used to analyze NG causes based on image data.	Refer to <i>6-5 Analyzing Inspection and Measurement Results [NG Analyzer]</i> on page 6-29.
	User data tool	Sets the initial value for user data that can be shared across scenes and across scene groups.	Refer to <i>A-12 Sharing Data Within the Controller [User Data Tool]</i> on page A-37
	Settings download and upload tools	Used to download and upload a list of set values for scene data as a CSV file.	Refer to <i>9-10 Outputting a list of Scene Data Setting Values [Setting Values Download/Upload Tools]</i> on page 9-51.
	Layout download and upload tools	Saves the layout settings of the Main Window in a file and loads the settings.	Refer to <i>9-11 Saving/Loading Layout Settings [Layout Upload, Download Tool]</i> on page 9-55.
	Image file save	Saves logged images and image files that are saved in the Controller.	Refer to <i>9-9 Saving Image Files to a RAMDisk or an External Storage Device [Image File Save]</i> on page 9-48.
	Registered Image Manager	Used to register the most recent input image, a logged image that is saved in the Controller or an image file and load it as a measurement image.	Refer to <i>6-7 Managing Images used for Model Registration and Reference [Registered Image Manager]</i> on page 6-42.
	Communication Command Marco	Creates a communication unit (Communication custom command) customized by user for FH/FHV/FZ5 series from external devices such as PLC.	Refer to <i>10-7 Customizing Communication Commands [Communication Command Macro]</i> on page 10-47.
	Flow viewer	Shows the flow of processing for the measurement flow that is currently being edited.	Refer to <i>5-4 Displaying and Checking Processing Branches in a Scene</i> on page 5-10.
	Calibration support tool	Graphically displays the relationship of the positions of the Camera coordinates and the actual coordinates.	Refer to <i>6-8 Verifying Calibration Results [Calibration Support Tool]</i> on page 6-47.

Main menu	Command	Description	Reference
Tool	Update standard position tool	Sets or changes the reference position for more than one processing unit specified in the measurement flow.	Refer to 6-6 <i>Updating the Reference Position Data for a Unit in the Measurement Flow [Update Standard Position Tool]</i> on page 6-38.
	Conversion scene group data tool	Creates a scene group that has more than 129 scenes.	Refer to 7-6 <i>Increasing the Number of Scenes in a Group to more than 128 Scenes [Conversion Scene Group Data Tool]</i> on page 7-12.
	Custom dialog tool	Used to create customized dialog boxes for setting processing items.	Refer to 8-4 <i>Creating a Custom Dialog Box [Custom Dialog Functions]</i> on page 8-67.
	Custom dialog	Displays a dialog box that is created with the custom dialog tool.	
	Scene Control Macro Tool	Complements or extends the operation of the measurement flow or scene.	Refer to 10-8 <i>Extending the Functions in a Measurement Flow or Scene [Scene Control Macro Tool]</i> on page 10-48.
	Configuration copy	Saves and loads all the various settings data files saved in the Sensor Controller.	Refer to 9-7 <i>Backing up Sensor Controller Setting Data [Configuration Copy]</i> on page 9-15..
	Line Maintenance	This tool can be used when using Multi-line random-trigger mode to copy settings data from one line to another line.	Refer to 9-8 <i>Copying Settings for Each Line in Multi-line Random-trigger Mode [Line Maintenance]</i> on page 9-32.
	Keyboard Layout selection tool	Sets the keyboard arrangement for the controller screen keyboard or for a USB connected keyboard.	Refer to 10-5 <i>Setting the Keyboard Layout for the Controller [Keyboard Layout Selection Tool]</i> on page 10-44.
	Device Information Storage Tool	This tool will prevent issues happening at start-up of the Sensor Controller due to recognition delay for external devices. Be sure to execute this tool when connecting external devices.	Refer to 3-6 <i>Saving Settings before Turning OFF the Power and Restarting</i> on page 3-34.
Window	Layout modification	Used to change any layout from layout 0 to layout 8.	Refer to 8-3 <i>Arranging Windows [Layout Functions]</i> on page 8-14.
	Layout setup	Sets whether to use the RUN signal output and external outputs for layouts 0 to 8.	

## A-2 External Tool List

External tool	Character string for setting
TDM editor	TDM-Editor.exe
System settings	FZ-SystemSetting.exe
Security settings	FZ-Security.exe
Scene Group Saving Destination Settings	ScgDataSaveDestination.exe
NG analyzer	FZ-Analyzer.exe
User data tool	FZ-UserData.exe
Settings download and upload	UnitDataToCsv.exe
Layout download and upload	LayoutToFile.exe
Image file save	ImageFileSave.exe
Registered image Manager	RegisteredImageManager2.exe
Communication command macro	FZ-IoMacro.exe
Flow viewer	FlowViewer.exe
Calibration support tool	FZ-CalibrationSupport.exe
Update standard position tool	FZ-UpdateStandardPosition.exe
Conversion scene group data tool	ConvertSgpDataTool.exe
Custom dialog tool	CustomDialog.exe
Custom dialog	CustomDialog.exe DialogStart
Scene control macro tool	FZ-SceneMacro.exe
Configuration copy	FZ-SettingManager.exe
Line maintenance	FZ-LineMaintenance.exe
Keyboard layout selection tool	SetKeyboardLayout.exe

## A-3 FHV series Processing items

In FHV series, the processing items that can be used with the FH series are different. The following shows the usability of processing items of FHV series.



### Important

FHV series cannot load data including processing items which it cannot be handled, but the Camera image input FH processing item data can be read in the FHV series.

### Measurement

Processing item	Support	Processing item	Support
Search	OK	Color Data	OK
Flexible Search	OK	Gravity and Area	OK
Sensitive Search	OK	Labeling	OK
ECM Search	—	Label Data	—
EC Circle Search	—	Defect	—
Shape Search II	—	Precise Defect	OK
Shape Search III	OK	Fine Matching	OK
Ec Corner	—	Character Inspection	OK
Ec Cross	—	Date Verification	OK
Classification	OK	Model Dictionary	OK
Edge Position	OK	2DCode II	OK
Edge Pitch	OK	2DCode	OK
Scan Edge Position	OK	Barcode	OK
Scan Edge Width	OK	Barcode	OK
Circular Scan Edge Position	OK	OCR	OK
Circular Scan Edge Width	OK	Circle Angle	—
Intersection	OK	Glue Bead Inspection	OK

### Input image

Processing item	Support	Processing item	Support
Camera Image Input	—	Photometric Stereo Image Input	—
Camera Image Input FH	—	Camera Switching	—
Camera Image Input FHV	OK	Measurement Image Switching	OK
Camera Image Input HDR	—	Multi-Trigger Imaging	OK
Camera Image Input HDR Lite	—	Multi-Trigger Imaging Task	OK



## Compensate image

Processing item	Support	Processing item	Support
Position Compensation	OK	Stripes Removal Filter II	OK
Filtering	OK	Polar Transformation	OK
Background Suppression	OK	Trapezoidal Correction	OK
Brightness Correct Filter	OK	Machine Simulator	—
Color Gray Filter	OK	Image Subtraction	OK
Extract Color Filter	OK	Advanced filter	OK
Anti Color Shading	OK	Panorama	—

## Support measurement

Processing item	Support	Processing item	Support
Unit Macro	—	Parallelize	OK
Unit Calculation Macro	—	Parallelize Task	OK
Calculation	OK	Statistics	OK
Line Regression	OK	Calibration Data Reference	OK
Circle Regression	OK	Position Data Calculation	OK
Precise Calibration	OK	Stage Data	OK
User Data	—	Robot Data	OK
Set Unit Data	—	Vision Master Calibration	OK
Get Unit Data	—	PLC Master Calibration	—
Set Unit Figure	—	Transfer Position Data	OK
Get Unit Figure	—	Calc Axis Move	OK
Trend Monitor	OK	Calc Axis Move by Multipoint	OK
Image Logging	OK	Detection Point	—
Image Conversion Logging	OK	Manual Position Setting	—
Data Logging	—	Camera Calibration	OK
Elapsed Time	OK	Data Save	—
Wait	OK	Conveyor Calibration	—
Focus	—	scene	OK
Iris	—	System information	OK

## Branch

Processing item	Support	Processing item	Support
Conditional Branch	—	Selective Branch	—
End	OK	Conditional execution (If)	OK
DI Branch	—	Conditional execution (Else)	OK
Control Flow Normal	—	loop	OK
Control Flow PLC Link	—	Loop suspension	OK
Control Flow Parallel	—	Select execution (Select)	OK
Control Flow Fieldbus	—	Select execution (Case)	OK

## Output result

Processing item	Support	Processing item	Support
Result output (I / O)	OK	Parallel Data Output	—
Result output (Message)	OK	Parallel Judgement Output	—
Data Output	—	Fieldbus Data Output	—

## Display result

Processing item	Support	Processing item	Support
Result Display	OK	Conveyor Panorama Display	—
Display Image File	—	Display image hold	OK
Display Last NG Image	OK		

## A-4 FHV series tools

In the FHV series, tools that can be operated on the FH series and the sensor controller and tools that can be operated on the simulation software are different. The tools that can be used for each are described below.

Tool	Sensor Controller	Simulation Software
TDM editor	Yes	Yes
System settings	Yes	Yes
Security settings	Yes	Yes
Scene Group Saving Destination Settings	No	No
NG analyzer	No	Yes
User data tool	No	No
Settings download and upload	No	Yes
Layout download and upload	No	Yes
Image file save	No	No
Registered image Manager	Yes	Yes
Communication command macro	No	No
Flow viewer	No	Yes
Calibration support tool	No	Yes
Update standard position tool	No	No
Conversion scene group data tool	No	Yes
Custom dialog tool	No	Yes
Custom dialog	Yes	Yes
Scene control macro tool	No	No
Configuration copy	Yes	Yes
Line maintenance	No	No
Keyboard layout selection tool	No	No
Device information strage tool	No	No

# A-5 Measurement Mechanism

This section describes how to configure measurement in accordance with the images acquired from cameras.

This product is prepared with comprehensive processing capabilities for measuring items. Common processes for various processing items are described here.

## A-5-1 Color Processing Mechanism

The images acquired from cameras are available with color information such as R(red)/G(green)/B(blue). RGB images can render 16.7 million colors on the screen, and adjustment of color intensity with a range of 0 to 255 can be performed.

For each of RGB, black is rendered with a 0 value and white is rendered with a 255 value.

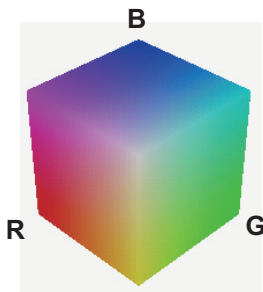

During measurement of color images, many colors can be measured by adjusting the values for RGB.

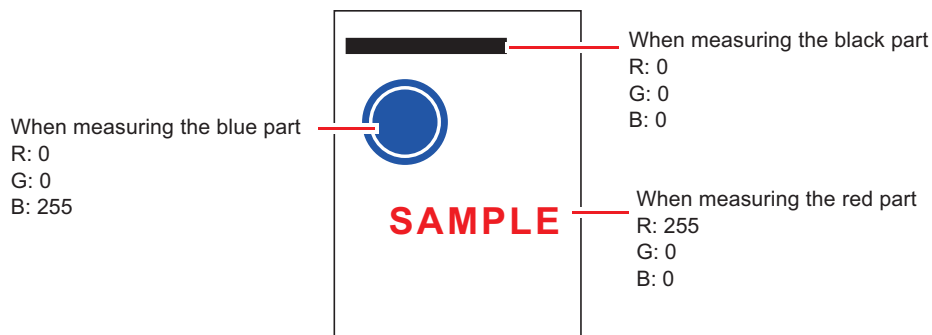

### Additional Information

For monochrome cameras, color processing is not performed.

## A-5-2 Search Processing Mechanism

Reference image patterns are registered as models and then search is performed for the parts of input images that most resemble the models. The degree of similarity is represented with a correlation value, inspection for defects and different parts being mixed in can be performed.

The search process is performed over several distinct stages.

- 1 Register a reference model.

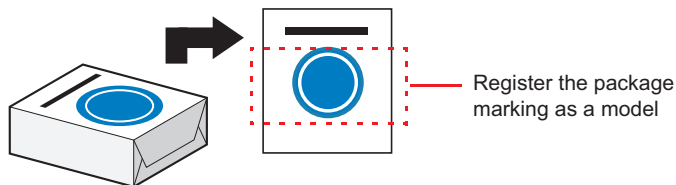

 **Additional Information**

### Model Status and Measurement Processing

- Measurement time and accuracy may be affected by the status of model in the following ways. Please select measurement objects that are in good condition (clean) for Model Registration.
  - In the case of large or complicated models, processing time is prolonged.
  - With extremely small models or models without features, search processing is unstable.

- 2 Perform rough search of overall measurement region.  
Search for the model over the entire measurement region.

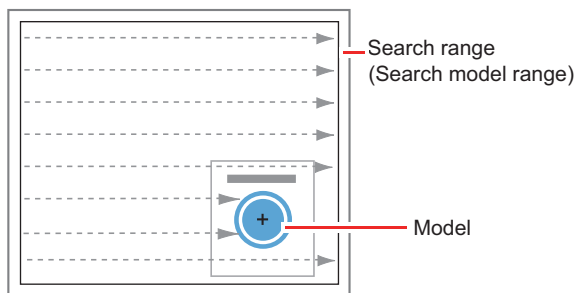

- 3 Perform additional searching near the model.

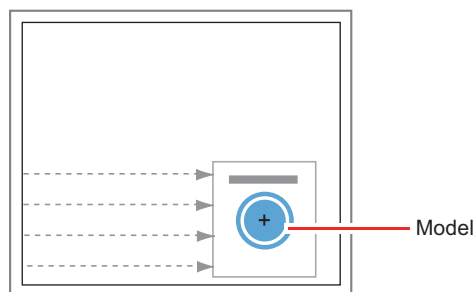

## Search Detection Method

With search processing, there are two types of detection methods: Search by "Correlation (CR)" and search by "Shape (PT)".

The detection method can be selected by changing the "Rotation" settings for each processing item.

Setting item	Description
CR	Measurement for locations where there is high correlation (similar areas) between the color of the model registration image and the input image is performed. Since brightness is normalized in this operation, changes in brightness do not affect searching for correct positions.
PT	Measurement for locations where there is a high degree of similarity between the shape of the model registration image and the input image is performed. Since measurement is based on shape consistency (profile of model), positions can be measured accurately even if portions of the model are missing in images.  When the rotation angle range is wide (such as full angle), a search that is faster than a "CR" search can be performed. Note, however, that this method may be less reliable than a "CR" search if the image has low contrast or blurred edges.



### Additional Information

#### Basic selection flow

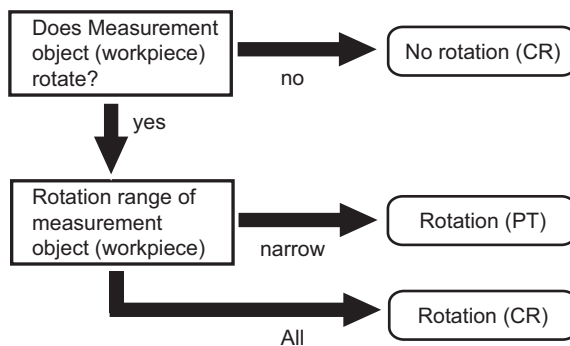

## Search Speed

For processing items to perform search processing such as [Search] and [Classification], you can specify the search processing speed by through the model parameter items "Stable", "Precise", and/or "Skipping angle". If the value specified for "Stab." or "Prec." is small or if the value for "Skipping angle" is large, the processing speed can be increased since the amount of information for the models will be decreased during the search. In contrast, if the values specified for "Stab." or "Prec." are large or if the value for "Skipping angle" is small, the processing speed is slow because search is performed without the amount of model information being reduced. Specify appropriate values for "Stable", "Precise", and "Skipping angle" according to the measurement conditions.

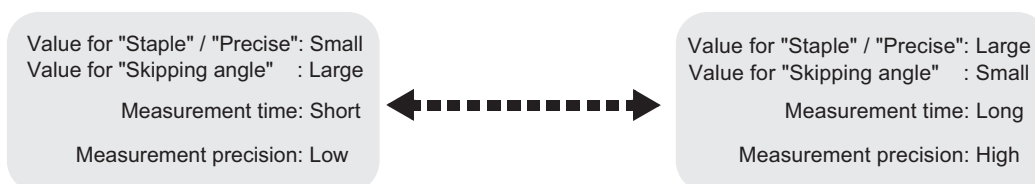

## Correlation Value

With processing items that use search processing, judgement is performed through correlation values. Correlation values are used to check the consistency (degree of similarity) between actual measurement images and reference model images. If portions of measured images are missing or if shapes are different, the correlation value is lower.

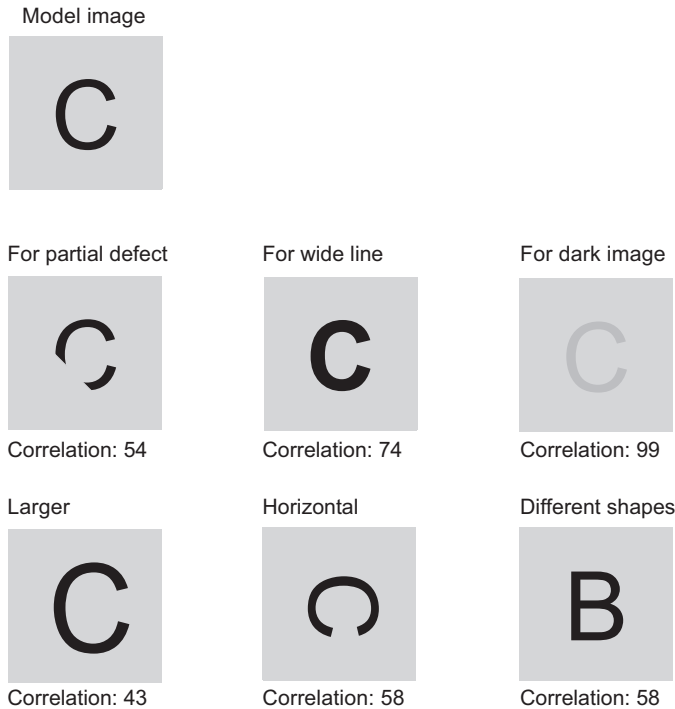

## Search Angle Range, Skipping Angle

These are values, based on the model registration image, that indicate the allowable rotation interval (skipping angle) and overall maximum rotation range for the model (angle range). Search is performed for objects that most resemble these acceptable models.

Example: When angle range is 15° and skipping angle is 5°

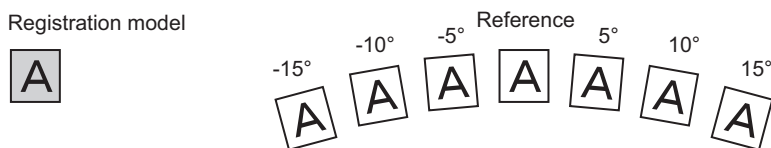

## Candidate Point Level

This is the level used for finding models when searching. Images with a correlation value higher than the candidate point level are used to establish candidate points for search inspection.

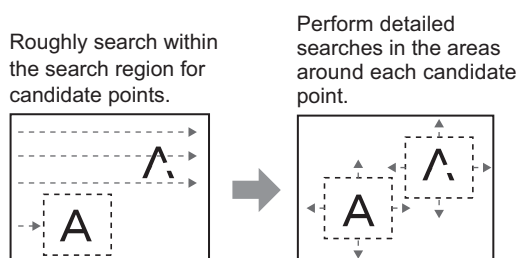

### A-5-3 Edge Detection Measurement

This method extracts parts with color changes as edges to perform measurement.

Edges are found through color changes in the measurement region.

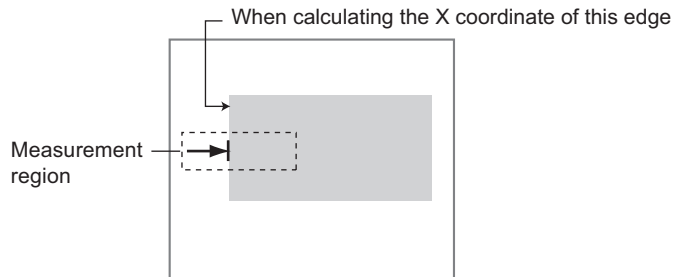



## Edge Detection Method

The following two types of edge detection method are available.

- Projection (Density method)

A projected waveform is formed relative to the density level. The intersection of the density and the threshold (edge level) is detected as an edge.

With an image with high noise level or image with blurry edges, the density method is suitable as it allows you to specify the density and color of the edges to be detected.

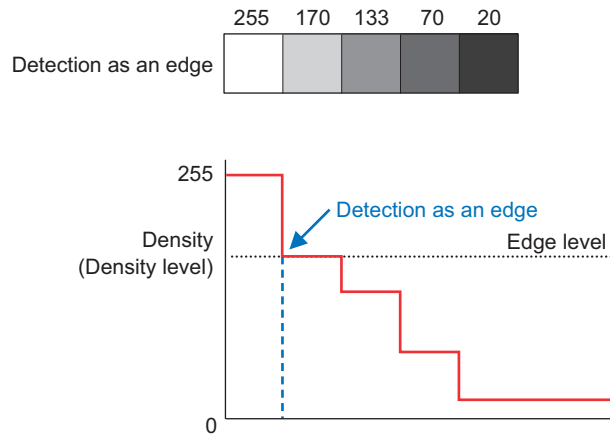

- Differential

A differential processing is performed to calculate the change in density between neighboring pixels. A differential waveform with the largest density set as 100% of the region is created, and the maximum value (peak point) of the differential waveform that exceeds the threshold (edge level) is detected as an edge.

With an image with low contrast, the differential method is suitable as it normalizes the differences between the neighboring pixels for processing.

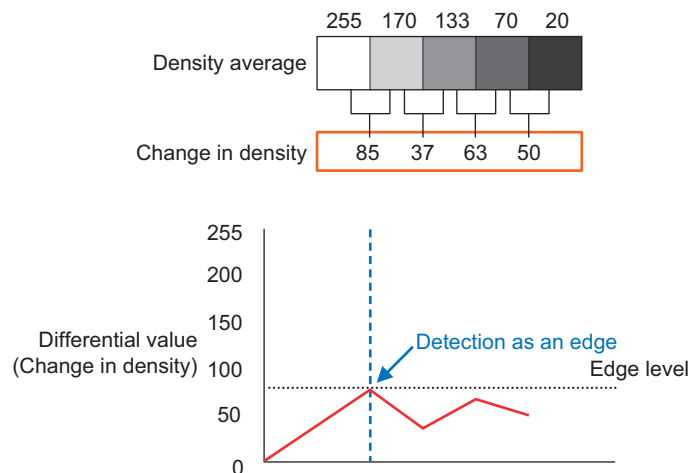

## Edge Level

Indicates the edge color change level (degree of color difference). This level is adjusted if edges cannot be accurately detected.



### Additional Information

The value 0 to 100 for the edge level indicates the edge intensity. It is not related to color difference in the original images.

- For case of measurement using relative position (%) with regards to width of color difference

The edges are detected in the following manner.

- 1** Calculate the overall distribution of color difference in the measurement region.
- 2** Min. color difference value: 0%; Max. color difference value: 100%
- 3** Locations in which there is an edge level color difference are detected as edges.
  - Edge Position

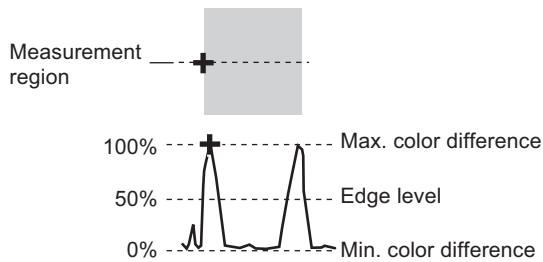

- Edge Pitch

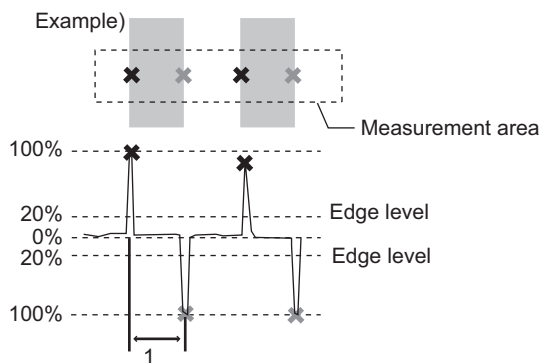

- When performing measurement using color difference value  
Edge level is set using color difference absolute value.

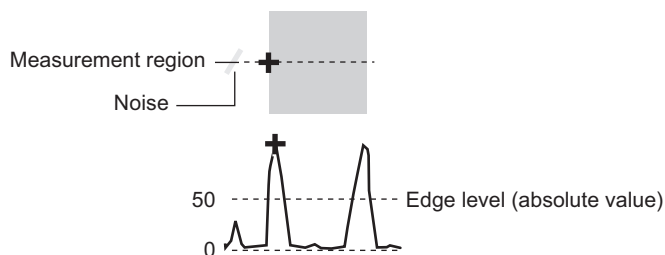

## Noise Level

This level judges whether an edge is present or not.

The maximum value and minimum value for color difference in the edge detection area are determined and if the difference is less than the noise level, it is judged that there is no edge. When detection is affected by noise, increase this value.

(within area)

Maximum value - minimum value of color difference < noise level - edge does not exist - measurement result is fail

Maximum value - minimum value of color difference > Noise level - edge exists - targeted for measurement

Example: When noise level is set to 30

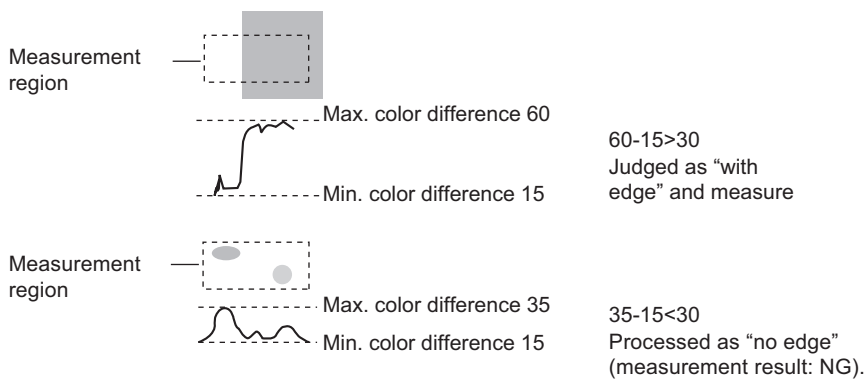

## Noise Width

Set the width for judging noise.

- When no color is specified

If another edge is detected within the width range starting from the point where an edge was first detected, the newly detected point is considered noise.

- When a color is specified

If the color difference distributions again falls below the edge level within the width range starting from the point where an edge was first detected, the newly detected point is considered noise.

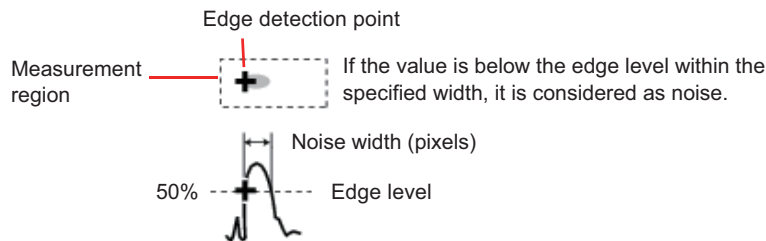

When points are mistakenly detected as edges due to noise, increase the color difference value.

## A-5-4 Defect Detection Measurement

Color changes within the measurement region are used to find defects such as scratches, contamination, and chipping.

After measurement region is drawn, a rectangle (defect detection region) is automatically formed in this region. While moving the defect detection region around, calculate average density for each area to determine the difference between the original area and the surrounding area. This difference is called the defect level. Calculate the defect level for all defect detection areas. If the maximum value exceeds the judgement value, it is judged that there are defects in the measurement region.

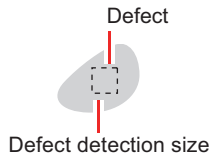

Increasing "Defect size" allows for shortening of processing time, but this will reduce measurement accuracy.

Setting item	Description
Upper Lower	<p>Specify the upper and lower limits of defect detection size based on the size of scratch or contamination to be detected.</p> <p>The larger the difference between upper and lower limits, the easier it is to detect the scratches or contamination of various sizes.</p> <p>For both upper and lower limits, higher values for defect detection size limits leads to weaker detection sensitivity and shorter processing time.</p> <div style="text-align: center;"> <p>Defect detection size —</p> <p>Defects —</p> <p>Sensitivity high ← → low</p> <p>Processing time long ← → short</p> </div>

## A-5-5 Handling Coordinates

The processing items for measuring positions have a setting item called "Output parameter" with which you can select how to handle coordinates.

In "Output parameter", you can set "Output coordinates" and "Calibration".

### Output Coordinates

Selects coordinate types to be output to external devices.

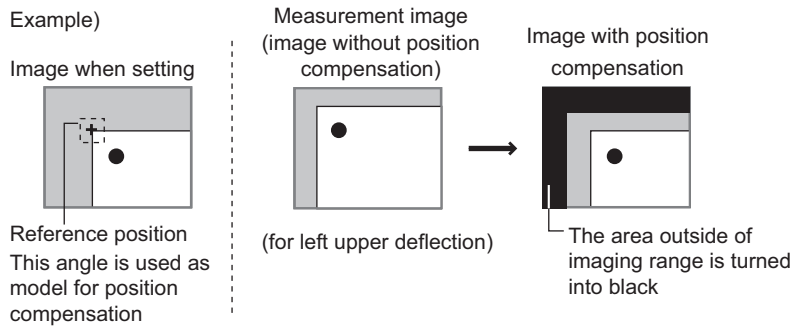

- Before position compensation

Coordinate values before position compensation are output.

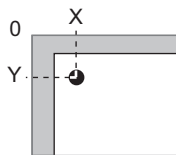

- After position compensation (with factory settings)

Coordinate values after position compensation are output.

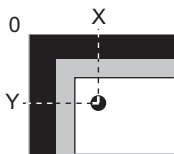

### Calibration

Select whether or not to perform calibration when selecting output to external devices.

- Calibration: ON  
Calibration is performed during output and measured values after calibration are output.
- Calibration: OFF  
Calibration is not performed during output, and coordinate values from camera images are output.

# A-6 Image file

IFZ/BMP(BFZ)/JPG(JFZ) file types can be selected as a save image file type.

Select the types according to user environment.

(Refer to 6-3-1 *Logging Measurement Values and Measurement Images [Data Logging/Image Logging]* on page 6-8, 3-2-3 *Selecting Files and Folders* on page 3-10.)

## IFZ file type

IFZ file type is an OMRON image file type using FH/FZ/FJ series or FQ series.

## BMP(BFZ) file type

BMP(BFZ) file types are image file types supported in software version 5.50, or later.

This is an image logging file format based on BMP image file types in a directory format.

The BFZ file format is for Multiple image logging and is actually a container file comprised of multiple BMP format image files. See the BFZ file structure below.

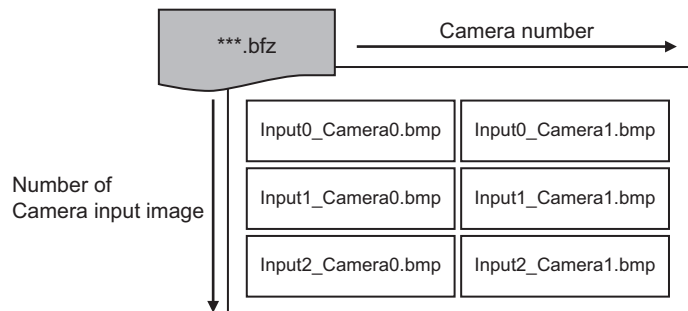

The file names for the BMP image files included in the BFZ image logging file are determined automatically.

The name is configured camera number and input order of camera input as below.

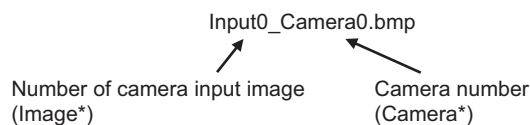

## JPG(JFZ) file type

JPG(JFZ) file types are image file types supported in software version 5.71, or later.

This is an image logging file format based on JPG image file types in a directory format.

The JFZ file format is for Multiple image logging and is actually a container file comprised of multiple JPG format image files. See the JFZ file structure below.

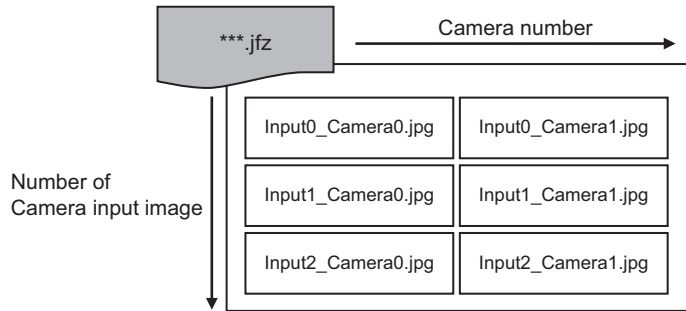

The file names for the JPG image files included in the JFZ image logging file are determined automatically.

The name is configured camera number and input order of camera input as below.

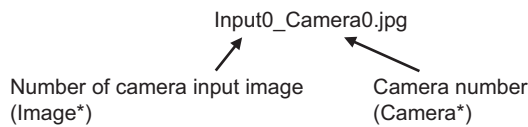

## Differences among IFZ/BMP(BFZ)/JFZ(JFZ) file types

Item	IFZ	BPM(BFZ)	JPG(JFZ)
File type	OMRON image file type.  This file type has been used in FH/FZ/FJ series.	Image file type configured BMP image file as a folder.  This file type was added from the Sensor Controller software version 5.50.	Image file format in which Jpeg format image files are organized in folders.  A file format added to Sensor controller software version 5.71
File function	For Multiple image logging function.	Corresponding Multiple image logging function.	Supports image logging for multiple image capture.
File compatibility	In Sensor Controller software version 5.30, or earlier, Loading, or measurement is supported and multiple camera configuration is also supported. However, because Multiple image logging is not supported, only the last logging image file can be loaded.	Same support as for a single BMP format image file in Sensor Controller software version 5.30, or earlier.	Loading and measuring with this file type is not supported in sensor controller software version 5.70 or earlier.  "Loading and measuring is supported in sensor controller software version 5.71 or later."  Since it is an irreversible compression image format, the measurement result differs from IFZ, or BMP (BFZ) format

Item	IFZ	BPM(BFZ)	JPG(JFZ)
Image file confirmation	<ol style="list-style-type: none"> <li>1. Confirm with Sensor Controller.</li> <li>2. Confirm using dedicated tools if you use PC or confirm to convert IFZ to other file type using same tool.</li> </ol>	<ol style="list-style-type: none"> <li>1. Confirm with Sensor Controller.</li> <li>2. Dedicated tools are not necessary if you use PC. Confirm it using general image display tools.</li> </ol>	<ol style="list-style-type: none"> <li>1. Confirm with Sensor Controller.</li> <li>2. Special tools are not necessary when using a PC. They can be confirmed with general image display tools.</li> </ol>
File size	---	This file size will be 3x the size of the IFZ file type for color images. For monochrome images, the size will not differ.	Jpeg format file size varies depending on image quality.
Save counts	---	The number of images that can be saved to an external device will be less.	The number of files that can be saved in external storage is larger than IFZ format, BMP (BFZ) format.
Processing time	---	The read/write processing time will be longer for the BMP(BFZ) file format due to the conversion to/from the IFZ image file format in Sensor Controller memory.	For the Read/Write time for JPG (JFZ) format images, there is some processing time to convert the image format (IFZ) captured in the sensor controller to JPG (JFZ) format.
Restrictions	If there is insufficient memory in the logging destination, the files will not be created.	If there is insufficient memory for the logging destination, the BMP files will not be created, but their container folder will be created.	When the capacity of the logging destination is insufficient, the JPG image is not created and only the folder is created.
Restrictions	---	<ul style="list-style-type: none"> <li>• Do not change the names of any BMP images included in the BMP(BFZ) file type. Measurement of loading image may not be executed when loads BMP(BFZ) file type.</li> <li>• If there are camera image input numbers for the BMP format files included in the BMP(BFZ) file type that are out of sequence, measurement will not be done on images after the first out of sequence.</li> </ul>	<ul style="list-style-type: none"> <li>• Do not change the name of the Jpeg format image file included in JPG (JFZ) format file. When loading a JPG (JFZ) format file, measurement of the loaded image may not be possible.</li> <li>• If the Camera Image Input number of the Jpeg image file included in the JPG (JFZ) file format becomes out of sequence, measurement on images after the out of sequence Camera Image Input number will not be performed.</li> </ul>
Restrictions	If you save as BMP(BFZ) format, the handling for the area outside the image differs from the IFZ file format and emphasizes ease of display. If you want to perfectly reproduce the measurement processing, including error processing on the outside part of the image, save it as IFZ file format.		<ul style="list-style-type: none"> <li>• The JPG (JFZ) format can be loaded and measured when the Sensor Controller software version is 5.71 or later. Since it is an irreversible compression image format, the measurement result differs from IFZ, or BMP (BFZ) format.</li> </ul>



# A-7 About Number of Logging Images

Maximum number of saveable logging images differ depending on type of Sensor Controller, type or counts of connected camera, number of camera input images in flow or settings.

The following table is the number of logging images depending on Sensor Controller type when you use one camera and take image at once.

The following table is the number of image logging when you take a picture for a camera.

Calculate the maximum number of image logging referring to the using the following table and numerical expressions.

## Calculation method

- 1** Confirm the following contents by the maximum number of image logging to calculate.
  - Model name of Sensor Controller
  - Type of connected camera
  - Number of connected cameras
  - Using times of processing unit items of camera image input in flow. (Camera image input, Camera image input FH, Camera image input FHV, Camera image input HDR or Camera image input HD)
  - Number of camera which transfers images of processing unit items of camera image input in flow. (Camera image input, Camera image input FH, Camera image input FHV, Camera image input HDR or Camera image input HD)
  - Settings for Multiple image logging function
- 2** Find the maximum number of logging(N) depending on model name of Sensor Controller and connected camera when you connect a camera and take a photo at once.  
(Example: When you use FH-1000 series and CCD camera (2 mega pixels with color), see the crossing point 43 of FH-1000 series and CCD camera (2 mega pixels).)
- 3** Number of connected camera is A.
- 4** Confirm [Multiple image logging] settings in Logging setting of System Settings.
- 5** Calculates the number of camera input processing items(B). (Camera image input, Camera image input FH, Camera image input HDR or Camera image input HD)
- 6** Calculates the number of camera transferring images each of camera image input processing items.  
(Example: The number of camera will be checked ones in [Transfer image] area selecting [Select camera] in Camera Image Input FH function.)
- 7** Calculates the number of transferred images by adding all of the camera in 6 step.
- 8** Calculates the maximum number of image logging using the following numerical expressions.
  - Multiple image logging function is [ON]  
The maximum number of image logging =  $N / C$  ( $C \leq A \times B$ )
  - Multiple image logging function is [OFF]  
The maximum number of image logging =  $N / A$

## Color camera

Model of Sensor Controller	Type of camera				
	CCD camera (0.3 mega pixels)	CCD camera (2 mega pixels)	CCD camera (5 mega pixels)	CMOS camera (0.3 mega pixels)	CMOS camera (0.4 mega pixels)
FZ5-L35□	250	40	11	---	---
FZ5-L35□-□□					
FZ5-6□□					
FZ5-6□□-□□					
FZ5-8□□	270	43	16	---	---
FZ5-8□□-□□					
FZ5-11□□					
FZ5-11□□-□□					
FZ5-12□□					
FZ5-12□□-□□					
FH-L□□□	270	43	16	270	215
FH-L□□□-□□					
FH-1□□□					
FH-1□□□-□□					
FH-3□□□					
FH-3□□□-□□					
FH-2□□□	812	130	50	812	646
FH-2□□□-□□					
FH-5□□□					
FH-5□□□-□□					

Model of Sensor Controller	Type of camera					Intelligent compact digital CMOS camera
	CMOS camera (2 mega pixels)	CMOS camera (4 mega pixels)	CMOS camera (5 mega pixels)	CMOS camera (12 mega pixels)	CMOS camera (20.4 mega pixels)	
FZ5-L35□	---	---	---	---	---	214
FZ5-L35□-□□						
FZ5-6□□						
FZ5-6□□-□□						
FZ5-8□□	---	---	---	---	---	232
FZ5-8□□-□□						
FZ5-11□□						
FZ5-11□□-□□						
FZ5-12□□						
FZ5-12□□-□□						
FH-L□□□	37	20	16	6	---	232
FH-L□□□-□□						
FH-1□□□						
FH-1□□□-□□						
FH-3□□□						
FH-3□□□-□□						
FH-2□□□	113	60	50 <sup>*1</sup>	20	12	696
FH-2□□□-□□						
FH-5□□□						
FH-5□□□-□□						

\*1. For FH-S05R: 40

## Monochrome camera

Model of Sensor Controller	Type of camera				
	CCD camera (0.3 mega pixels)	CCD camera (2 mega pixels)	CCD camera (5 mega pixels)	CMOS camera (0.3 mega pixels)	CMOS camera (0.4 mega pixels)
FZ5-L35□	252	40	11	---	---
FZ5-L35□-□□					
FZ5-6□□					
FZ5-6□□-□□					
FZ5-8□□	272	43	6	---	---
FZ5-8□□-□□					
FZ5-11□□					
FZ5-11□□-□□					
FZ5-12□□					
FZ5-12□□-□□					
FH-L□□□	272	43	16	272	215
FH-L□□□-□□					
FH-1□□□					
FH-1□□□-□□					
FH-3□□□					
FH-3□□□-□□					
FH-2□□□	812	130	50	812	646
FH-2□□□-□□					
FH-5□□□					
FH-5□□□-□□					

Model of Sensor Controller	Type of camera				
	CMOS camera (2 mega pixels)	CMOS camera (4 mega pixels)	CMOS camera (5 mega pixels)	CMOS camera (12 mega pixels)	CMOS camera (20.4 mega pixels)
FZ5-L35□	---	---	---	---	---
FZ5-L35□-□□					
FZ5-6□□					
FZ5-6□□-□□					
FZ5-8□□	---	---	---	---	---
FZ5-8□□-□□					
FZ5-11□□					
FZ5-11□□-□□					
FZ5-12□□					
FZ5-12□□-□□					
FH-L□□□	37	20	16	6	---
FH-L□□□-□□					
FH-1□□□					
FH-1□□□-□□					
FH-3□□□					
FH-3□□□-□□					
FH-2□□□	113	60	50 <sup>*1</sup>	20	12
FH-2□□□-□□					
FH-5□□□					
FH-5□□□-□□					

\*1. For FH-SM05R: 49

**FHV series**

---

	FHV7□-□004	FHV7□-□016	FHV7□-□032	FHV7□-□050	FHV7□-□063R	FHV7□-□120R
Number of Logging Images	256	52	25	15	12	5

# A-8 About Max. Number of Loading Images during Multi-input

The function that enables continuous high speed image input is called the multi-input function.  
 The maximum number of images that can be loaded based on each specification is shown below.

## FH/FZ5 series

Type of controller	0.3 megapixel camera	2 megapixel camera	5 megapixel camera
FZ5-L35□	16 (for cameras 0 and 1)	4 (for cameras 0 and 1)	1 (for cameras 0 and 1)
FZ5-L35□-□□	32 (for cameras 2 and 3)	8 (for cameras 2 and 3)	2 (for cameras 2 and 3)
FZ5-6□□	32	8	2
FZ5-6□□-□□			
FZ5-8□□	32	8	2
FZ5-8□□-□□			
FZ5-11□□			
FZ5-11□□-□□			
FZ5-12□□			
FZ5-12□□-□□			
FH-1□□□	256	64	25
FH-1□□□-□□			
FH-2□□			
FH-2□□-□□			
FH-3□□□			
FH-3□□□-□□			
FH-5□□			
FH-5□□-□□			
FH-L□□□			
FH-L□□□-□□			

Type of controller	0.3 megapixel camera	0.4 megapixel camera	2 megapixel camera	4 megapixel camera	5 megapixel camera	12 megapixel camera	20.4 megapixel camera
FZ5-L35□	---	---	---	---	---	---	---
FZ5-L35□-□□	---	---	---	---	---	---	---
FZ5-6□□	---	---	---	---	---	---	---
FZ5-6□□-□□	---	---	---	---	---	---	---
FZ5-8□□	---	---	---	---	---	---	---
FZ5-8□□-□□	---	---	---	---	---	---	---
FZ5-11□□	---	---	---	---	---	---	---
FZ5-11□□-□□	---	---	---	---	---	---	---
FZ5-12□□	---	---	---	---	---	---	---
FZ5-12□□-□□	---	---	---	---	---	---	---



Type of controller	0.3 megapixel camera	0.4 megapixel camera	2 megapixel camera	4 megapixel camera	5 megapixel camera	12 megapixel camera	20.4 megapixel camera
FH-1□□□	256	256	51	32	25	10	6
FH-1□□□-□□							
FH-2□□							
FH-2□□-□□							
FH-3□□□							
FH-3□□□-□□							
FH-5□□							
FH-5□□-□□							
FH-L□□□							
FH-L□□□-□□							



**Important**

- The multi-input function cannot be used when the built-in lighting of an Intelligent Compact Digital Camera, FZ-SQ□□□□, is used.
- The maximum number of images loaded does not change even if partial reading of camera images is selected.  
When using two camera cables for connection, the maximum number of loaded images during multi-input is twice the number given in the table.

**FHV series**

	FHV7□-□004	FHV7□-□016	FHV7□-□032	FHV7□-□050	FHV7□-□063R	FHV7□-□120R
Number of Logging Images	256	64	36	25	19	10

## A-9 About Memories Usable with FH series/FZ5 series

---

The following types of memory can be used with FH series/FZ5 series Sensor Controller.

- On-board memory

This is the area where images are temporarily stored when logging images using the logging function.

This uses ring memory and if the maximum number of save images has been reached, images are overwritten starting with the oldest. This is cleared when the power is turned OFF.

- RAMDisk

Image logging file, data logging file, and capture images can be saved.

As this is memory inside the FZ4, files can be saved and read faster than using USB memory.

However, capacity is a fixed 40 MB (256 MB for FH series/FZ5-800/1100/1200 series Sensor Controller) . Files saved in RAMDisk are cleared when the power is turned OFF.

- Application memory

This is a memory used for all applications.

This is a memory area that is used temporarily by applications. By confirming available memory, this provides a rough standard for confirming status while operating. The user has no access to it.

- Data memory (FH-L series/FZ5-600 series Sensor Controller)

This is an area for holding current settings details of scene group data.

If this capacity is exceeded, adding units and copying scenes cannot be performed in edit flow.

Available data memory can be confirmed from the system menu.

Refer to *3-4 Checking the Memory Consumption and Percentage of Memory Used* on page 3-31 and *3-3 Checking System Information* on page 3-27.

# A-10 Memory Usage Guidance For Processing Items

Free space is required in the application memory or data memory (FH-L series/FZ5-600 series Sensor Controller only) in order to add a processing unit to the measurement flow. The amount of free space required in memory consists of both the amount necessary to add a processing unit to the measurement flow, and the amount necessary to configure settings for the added unit and execute measurement.

When adding a new processing unit to the measurement flow, or if the memory becomes insufficient when settings are configured, refer to the table below for the approximate amount of memory used and delete a processing unit from the measurement flow or adjust the processing unit settings.

The amount of used memory and free data memory can be checked from the menu of Memory Consumption Monitor on the Measurement Management Bar or the system menu.

Refer to 3-4 *Checking the Memory Consumption and Percentage of Memory Used* on page 3-31 and 3-3 *Checking System Information* on page 3-27.

To adjust each processing unit, refer to the section for each processing item in the Processing Item Function Reference Manual. (Refer to Processing Item Function Reference Manual (Cat. No. Z341))

Item	Approximate memory usage		Main settings that affect change of memory used
	Adding to measurement flow	Change due to settings	
Search	Approx. 2 KB	Approx. 544 MB (for monochrome image) Approx. 1609 MB (for color image)	Model registration figure, model parameters, saved settings of model registration image, image size, number of detections, whether image is color or monochrome.
Flexible Search	Approx. 2 KB	Approx. 2,655 MB (for monochrome image) Approx. 7,856 MB (for color image)	Model registration count, model registration figure, model parameters, image size, whether image is color or monochrome.
Sensitive Search	Approx. 8 KB	Approx. 1,088 MB (for monochrome image) Approx. 3,218 MB (for color image)	Model registration figure, model parameters, image size, whether image is color or monochrome.
ECM Search	Approx. 2 KB	Approx. 2 MB	Model registration figure, error model registration figure, extraction amount of edge extraction, image size.
EC Circle Search	Approx. 24 KB	Approx. 1 MB	-
Shape Search II	Approx. 6 KB	Approx. 57 MB	Model registration figure, model parameters, saved settings of model registration image, image size, shape of edge in image.
Shape Search III	Approx. 3 KB	Approx. 335 MB	Model registration figure, model parameters, saved settings of model registration image, image size, number of detections, shape of edge in image.
Ec Corner	Approx. 62 KB	No change	-
Ec Cross	Approx. 34 KB	No change	-



Item	Approximate memory usage		Main settings that affect change of memory used
	Adding to measurement flow	Change due to settings	
Classification	Approx. 41 KB	Approx. 543,477 MB (for monochrome image) Approx. 1,608,757 MB (for color image)	Model registration count, model registration figure, model parameters, image size, whether image is color or monochrome.
Edge Position	Approx. 1 KB	Approx. 1 MB	Measurement region figure, image size.
Edge Pitch	Approx. 5 KB	Approx. 1 MB	Measurement region figure, image size.
Scan Edge Position	Approx. 2 KB	Approx. 12 MB	Measurement region figure, number of measurement points, image size.
Scan Edge Width	Approx. 2 KB	Approx. 23 MB	Measurement region figure, number of measurement points, image size.
Circular Scan Edge Position	Approx. 2 KB	Approx. 42 MB	Measurement region figure, number of measurement points, image size.
Circular Scan Edge Width	Approx. 2 KB	Approx. 83 MB	Measurement region figure, number of measurement points, image size.
Intersection	Approx. 4 KB	Approx. 23 MB	Measurement region figure, image size.
Color Data	Approx. 1 KB	Approx. 25 MB	Measurement region figure, selected region figure of static mask, image size.
Gravity and Area	Approx. 1 KB	Approx. 25 MB	Measurement region figure, selected region figure of static mask, image size.
Labeling	Approx. 2 KB	Approx. 25 MB	Measurement region figure, selected region figure of static mask, image size, maximum number of labels.
Label Data	Approx. 1 KB	No change	-
Defect	Approx. 1 KB	Approx. 51 MB	Measurement region figure, selected region figure of static mask, image size.
Precise Defect	Approx. 20 KB	Approx. 29 MB	Measurement region figure, detection parameter settings, selected region figure of static mask, image size.
Fine Matching	Approx. 1 KB	Approx. 38 MB (for monochrome image) Approx. 63 MB (for color image)	Model registration figure, image size, whether image is color or monochrome.
Character inspection	Approx. 4 KB	No change	-
Date Verification	Approx. 1 KB	Approx. 1 MB	Length of character string, code parameter settings.
Model Dictionary	Approx. 4 KB	Approx. 95,567 MB (for monochrome image) Approx. 282,801 MB (for color image)	Model registration count, model registration figure, model parameters, image size, whether image is color or monochrome.
2DCode	Approx. 12 KB	Approx. 1 MB	Length of comparison character string, number and length of sorting comparison character strings.
Barcode	Approx. 3 KB	Approx. 1 MB	Length of comparison character string, number and length of sorting comparison character strings.
OCR	Approx. 704 KB	Approx. 1 MB	Number and length of character string formats, number and length of comparison strings, number and length of teaching correct response values, code parameter settings.

Item	Approximate memory usage		Main settings that affect change of memory used
	Adding to measurement flow	Change due to settings	
OCR User Dictionary	Approx. 1 KB	Approx. 1 MB	-
Circle Angle	Approx. 1 KB	Approx. 1 MB	Graduated angle, whether image is color or monochrome.
Glue Bead Inspection	Approx. 1 KB	Approx. 25 MB	Measurement region figure, mask region figure, image size.
Camera Image Input	Approx. 1 KB	Approx. 9 MB (for monochrome image) Approx. 17 MB (for color image)	Model registration figure of calibration settings, image size, whether image is color or monochrome.
Camera Image Input FH	Approx. 1 KB	Approx. 9 MB (for monochrome image) Approx. 17 MB (for color image)	Model registration figure of calibration settings, image size, whether image is color or monochrome.
Camera Image Input HDR	Approx. 3 KB	Approx. 9 MB (for monochrome image) Approx. 17 MB (for color image)	Model registration figure of calibration settings, image size, whether image is color or monochrome.
Camera Image Input HDR Lite	Approx. 1 KB	Approx. 9 MB (for monochrome image) Approx. 17 MB (for color image)	Model registration figure of calibration settings, image size, whether image is color or monochrome.
Camera Switching	Approx. 1 KB	No change	-
Measurement Image Switching	Approx. 1 KB	No change	-
Position Compensation	Approx. 1 KB	Approx. 1 MB	Number and length of calculation expressions
Filtering	Approx. 1 KB	No change	-
Background Suppression	Approx. 1 KB	No change	-
Brightness Correct Filter	Approx. 1 KB	No change	-
Color Gray Filter	Approx. 1 KB	No change	-
Extract Color Filter	Approx. 1 KB	No change	-
Anti Color Shading	Approx. 1 KB	No change	-
Stripes Removal Filter II	Approx. 1 KB	No change	-
Polar Transformation	Approx. 1 KB	Approx. 1 MB	Circle radius, circle width, end point overlay, image size.
Trapezoidal Correction	Approx. 1 KB	Approx. 1 MB	Number and length of calculation expressions
Machine Simulator	Approx. 1 KB	No change	-
Image Subtraction	Approx. 1 KB	Approx. 63 MB	Model registration figure, image size.
Advanced filter	Approx. 9 KB	No change	-
Panorama	Approx. 240 KB	Approx. 13 MB	Whether brightness correction reference image is used, image size.
Unit Macro	Approx. 1 KB	Approx. 4 MB	Length of program code
Unit Calculation Macro	Approx. 1 KB	Approx. 2 MB	Length of program code
Calculation	Approx. 1 KB	Approx. 1 MB	Number and length of calculation expressions, number and length of comments.
Line Regression	Approx. 3 KB	Approx. 1 MB	Number of points, number and length of calculation expressions
Circle Regression	Approx. 2 KB	Approx. 1 MB	Number and length of calculation expressions

Item	Approximate memory usage		Main settings that affect change of memory used
	Adding to measurement flow	Change due to settings	
Precise Calibration	Approx. 660 KB	Approx. 51 MB	Measurement region figure, image size, specified calibration method.
User Data	Approx. 6 KB	Approx. 1 MB	Number and length of calculation expressions
Set Unit Data	Approx. 1 KB	Approx. 1 MB	Length of calculation expression.
Get Unit Data	Approx. 1 KB	No change	-
Set Unit Figure	Approx. 1 KB	Approx. 1 MB	Number and length of calculation expressions, number of figures, figure type.
Get Unit Figure	Approx. 1 KB	No change	-
Trend Monitor	Approx. 20 KB	Approx. 3 MB	Length of calculation expression, number of items saved.
Image Logging	Approx. 1 KB	Approx. 1 MB	Length of calculation expression, length of sub-folder name, length of prefix
Image Conversion Logging	Approx. 200 KB	Approx. 1 MB	Length of calculation expression, length of folder name, length of prefix
Data Logging	Approx. 1 KB	Approx. 1 MB	Number and length of calculation expressions, number and length of comments, length of file name, length of sub-folder name, length of prefix.
Elapsed Time	Approx. 1 KB	No change	-
Wait	Approx. 1 KB	No change	-
Focus	Approx. 1 KB	Approx. 13 MB	Figure in region settings, image size.
Iris	Approx. 1 KB	Approx. 13 MB	Figure in region settings, image size.
Parallelize	Approx. 1 KB	No change	-
Parallelize Task	Approx. 1 KB	No change	-
Statistics	Approx. 8 KB	Approx. 1 MB	Number and length of calculation expressions, number and length of comments.
Calibration Data Reference	Approx. 1 KB	No change	-
Position Data Calculation	Approx. 2 KB	Approx. 1 MB	Number and length of calculation expressions
Stage Data	Approx. 1 KB	No change	-
Robot Data	Approx. 1 KB	No change	-
Vision Master Calibration	Approx. 82 KB	Approx. 402 MB	Image size.
PLC Master Calibration	Approx. 81 KB	Approx. 402 MB	Image size.
Transfer Position Data	Approx. 2 KB	Approx. 1 MB	Number and length of calculation expressions
Calc Axis Move	Approx. 4 KB	Approx. 1 MB	Number and length of calculation expressions
Calc Axis Move by Multi-point	Approx. 5 KB	Approx. 1 MB	Number and length of calculation expressions
Detection Point	Approx. 1 KB	Approx. 1 MB	Number and length of calculation expressions
Camera Calibration	Approx. 7 KB	No change	-
Data Save	Approx. 1 KB	Approx. 1 MB	Number and length of calculation expressions, number and length of comments.
Conveyor Calibration	Approx. 20 KB	No change	-
Conditional Branch	Approx. 1 KB	Approx. 1 MB	Number and length of calculation expressions
End	Approx. 1 KB	No change	-
DI Branch	Approx. 1 KB	No change	-
Control Flow Normal	Approx. 1 KB	No change	-

Item	Approximate memory usage		Main settings that affect change of memory used
	Adding to measurement flow	Change due to settings	
Control Flow PLC Link	Approx. 1 KB	No change	-
Control Flow Parallel	Approx. 1 KB	No change	-
Control Flow Fieldbus	Approx. 1 KB	No change	-
Selective Branch	Approx. 3 KB	Approx. 1 MB	Length of conditional expression, number and length of branch setting comments.
Data Output	Approx. 14 KB	Approx. 1 MB	Communication module settings, number and length of calculation expressions, number and length of comments.
Parallel Data Output	Approx. 1 KB	Approx. 1 MB	Communication module settings, number and length of calculation expressions, number and length of comments.
Parallel Judgement Output	Approx. 1 KB	Approx. 1 MB	Number and length of calculation expressions, number and length of comments.
Fieldbus Data Output	Approx. 6 KB	Approx. 1 MB	Communication module settings, number and length of calculation expressions, number and length of comments.
Result Display	Approx. 1 KB	Approx. 1 MB	Result display type, number of results displayed, number and length of calculation expressions, number and length of characters.
Display Image File	Approx. 1 KB	Approx. 1 MB	Number and length of file names.
Display Last NG Image	Approx. 3 KB	Approx. 1 MB	Number and length of calculation expressions, number and length of comments.
Conveyor Panorama Display	Approx. 491 KB	No change	-

# A-11 Memory Display Image on PLC I/O

The memory display image on PLC I/O varies depending on the PLC to be used.

Using data output to the Data Output area of the PLC link from the serial data output processing item as an example, this section illustrates how the memory display image varies depending on the model.

## ● Data storage image (Data Output area DM1000)

When the PLC link Data Output area is set to DM1000, data is stored as follows in the PLC I/O memory.

- \*1. Up to 8 expressions can be registered in the serial output flow on the FZ4 side. If 8 expressions are registered, data is stored as follows.

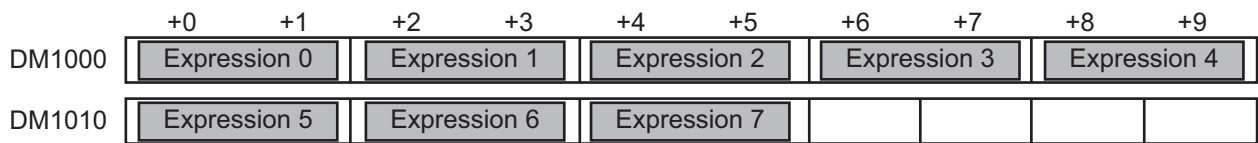

## ● CX-Programmer PLC I/O memory display image

As an example, if 3 data items, expression 0 (DATA0) = 1.000, expression 1 (DATA1) = 200.000, and expression 2 (DATA2) = 1000.000, are output from FZ4, they are stored to the PLC Link area as measurement data as follows.

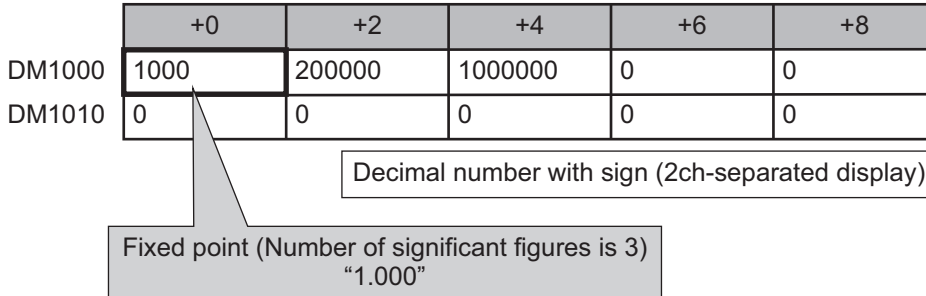

- \*1. Data is stored to the PLC I/O memory as follows for a decimal number per channel.

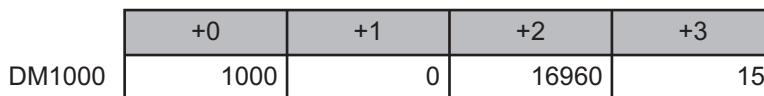

● **GX-Developer PLC I/O memory display image**

As an example, if 3 data items, expression 0 (DATA0) = 1.000, expression 1 (DATA1) = 200.000, and expression 2 (DATA2) = 1000.000, are output from FZ4, they are stored to the PLC Link area as measurement data as follows.

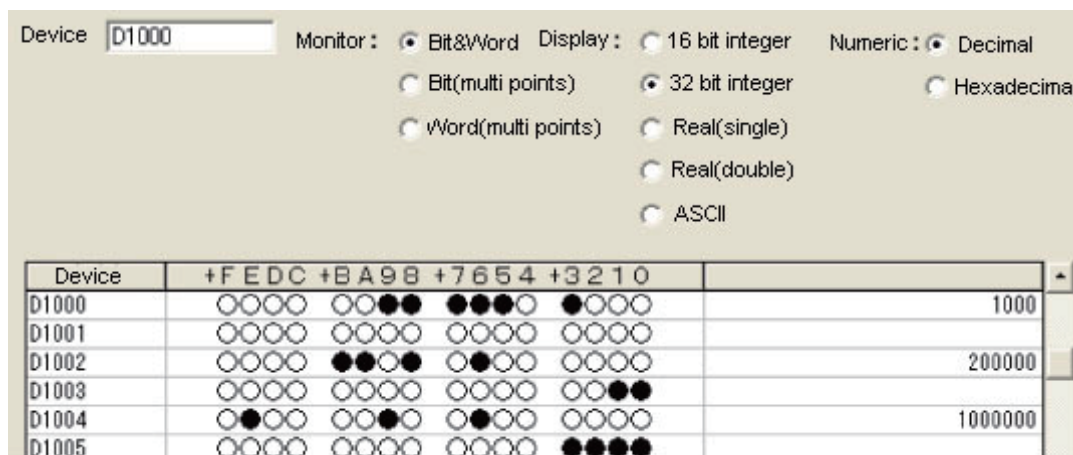

\*1. Data is stored to the PLC I/O memory as follows for a decimal number per channel.

	+0	+1	+2	+3	+4	+5
DM1000	1000	0	3392	3	16960	15

# A-12 Sharing Data Within the Controller [User Data Tool]

This tool is used to share data within the Controller.

This function can not be used with the FHV series.

The data set as user data is shared between scenes or scene groups. Data sharing across lines is not allowed in Multi-line Random Trigger Mode. The data variables that are created are stored in the user data region on the Controller.

Use the User Data Tool to edit data, specify initial values, and enter data comments.

Use the User Data processing item to set or reference the values in the data that you set with the User Data Tool.

Refer to *User Data* in the *Vision System FH/FHV/FZ5 Series Processing Item Function Reference Manual* (Cat. No. Z341).



## Additional Information

When creating a measurement flow newly, use System variables.

For details, refer to 5-5-3 *Editing Scenes* on page 5-34.

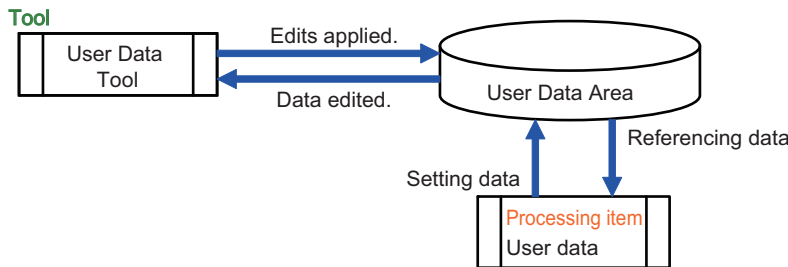

## A-12-1 Setting Procedure for User Data

- 1 To set user data, select [User data tool] from the [Tool] menu in the Main Window. The [User data tool] dialog box is displayed.

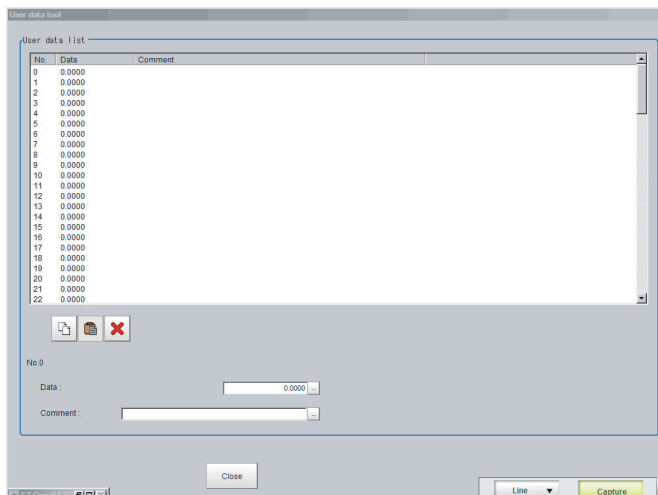

- 2** Click the data to set.  
 The data, 0.0000 (Not set), shows that user data has not been created yet.  
 When using user data, be sure to set the value.  
 When setting 0 as the default, set 0.

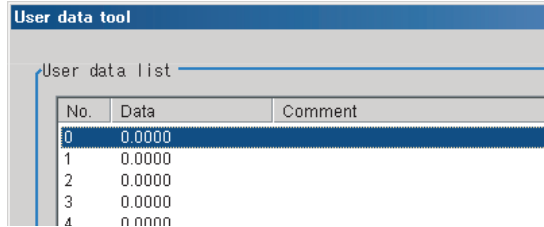

- 3** Set the default value for the data.

Item	Set value [Factory default]	Description
Data	-999999999.9999 to 999999999.9999 [0.0000]	Sets the specified user data value. This supports multi-lingual. Refer to 3-2-2 <i>Inputting Text</i> on page 3-7.

- 4** Enter the comment for the data.  
 The entered comment will be displayed in the [Comment] column of the User Data processing item.

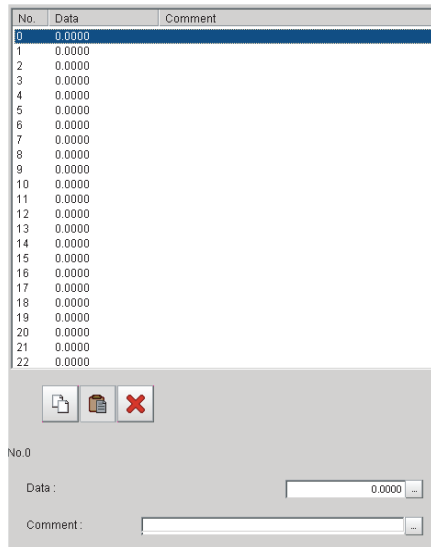

Item	Set value [Factory default]	Description
Comment	64 characters max. [Space]	Sets the comments for the specified user data. This supports multi-lingual. Refer to 3-2-2 <i>Inputting Text</i> on page 3-7.

- 5** Repeat steps 2 to 4 to set the user data.  
 Up to 100 user data (No. 0 to 99) can be set.
- 6** To exit the User Data Tool, click [Close].
- 7** Click [Data save] to save the specified user data Set Values (Settings download and upload tools)

To create a list of the set values for scene data, use the Settings Download and Upload Tools.

With the set value download function, the specified scene data set values can be output to a CSV file. Different set values in multiple scene data can be easily checked by opening the CSV files in an editor. (Only data that can be read and written can be downloaded.) The Setting Values Upload Tool allows you to upload a CSV file with confirmed set values.



# A-13 About Limits on the Number of Image Input Processing Items Used

For the FZ5-L/FZ5-600 series, The number of image input processing items that can be used within one scene is limited by the combinations of the camera. (Units that are not used in conditional branching, etc. are also targeted.)

If the limit is exceeded, a measurement NG (image mismatch) occurs due to a memory shortage during measurement.

Please use within this processing items limitation.

Camera used	Number of image input related processing item restriction
0.3 mega pixels color camera	81
0.3 mega pixels monochrome camera	245
Intelligent Compact Digital Camera (FZ-SQ)	69
2 mega pixels color camera	13
2 mega pixels monochrome camera	39
5 mega pixels color camera	6
5 mega pixels monochrome camera	19

## ● Image input related processing items

Target processing items are as follows.

Item	Processing item	Item	Processing item
Loading Images	Camera Image Input	Performing image compensation	Anti Color Shading
	Camera Image Input HDR		Stripes Removal Filter II
	Camera Switching		Polar Transformation *1
	Camera Image Input FH		Image Subtraction
	Camera Image Input HDR Lite		Advanced Filter*2
Performing image compensation	Position Compensation	Inspection and measurement support items	Machine Simulator
	Filtering		Panorama
	Background Suppression		Trapezoidal Correction
	Brightness Correct Filter	Display result to the window	Precise Calibration
	Color Gray Filter		Calibration Data Reference
	Extract Color Filter		Display Image File*3
		Display Last NG image*4	
		Conveyor Panorama Display	

\*1. When using a Polar Transformation, each image input related unit after Polar Transformation may consume up to a maximum of 2 items.

\*2. For each unit, 4 items are consumed for Advanced Filter.

\*3. Image file display consumes the number of image setting value items per unit.

\*4. Display Last NG Image consumes the number of save setting value items per unit.



### Important

- If there is one or more "Sensitive Search" in the flow, the number of image input items that can be used is only reduced by one.
- In the case of the FH series / FZ5-800/1100/1200 series, the number of processing items is not limited and can be registered as long as there is sufficient free memory. Note, however, that a warning message is displayed when the available memory drops to below 1 GB. In this case, adjust the inspection flow to ensure at least 1 G of available memory.

# A-14 Operation log input information list

This is a list of operation log input information. For the operation log format, see below.  
 Refer to *10-4-2 Operation Log Format* on page 10-43.

Name	Description	References
AddGlobalData	Adds global data.	*1
AddSystemData	Adds system data.	*1
AssignProc	Assigns units to measurement flows.	---
AssignUnit	Registers a processing unit.	*1
BeginSetupUnit	Enters into the unit setting screen.	---
ChangeScene	Switches to the specified scene.	*1
ChangeSceneGroup	Switches to the specified scene group.	*1
CheckAccessControl	Checks the operation authority.	Refer to <i>Checking Operation Restrictions (P.A-44)</i> .
ClearImageLogCount	Clears the logging count information.	Refer to <i>Clearing the Logging Count Information (P.A-44)</i> .
ClearMeasureData	Clears the measurement results for the processing unit.	*1
ClearMeasureData_S	Clears the measurement results for the processing unit.	---
ClearScene	Clears the scene.	*1
ClearSceneGroup	Clears a scene group.	*1
ClearSecurityData	Clears security related parameters.	Refer to <i>Clearing Security Related Parameters (P.A-44)</i> .
ClearSettingData	Clears setting data.	Refer to <i>Clearing Setting Data in a Batch (P.A-44)</i> .
ConvertImageFileF	Converts an image file.	---
ConvertImageFileM	Converts an image file.	---
CopyFile	Copies a file.	Refer to <i>Copy File (P.A-45)</i> .
CopyScene	Copies scene data.	*1
CopySceneGroup	Copies a scene group.	*1
CopyUnit	Copies a processing unit.	*1
CopyUnit2	Copies a processing unit.	---
CopyUnitFigure	Copies the figure data for a processing unit.	*1
CopyUnitModel	Copies the model data for a processing unit.	*1
CreateDirectory	Creates a directory.	Refer to <i>Directory Creation (P.A-45)</i> .
DeleteUnit	Deletes a processing unit.	*1
DeleteUserAccount	Deletes a user account.	Refer to <i>Deleting a User Account (P.A-45)</i> .
EndSetupUnit	Closes the unit setting screen.	---
ExitFzProcess	Exits an FZ process.	*1
GetAll	Executes batch input of parallel I/O and other terminal states.	*1
GetDensityProfile	Acquires the image density information.	Refer to <i>Getting Image Density Information (P.A-46)</i> .
GetGlobalData	Acquires global data.	*1
GetHistogram	Acquires the image histogram.	Refer to <i>Getting an Image Histogram (P.A-46)</i> .
GetImageCountM	Acquires the image count.	---

Name	Description	References
GetImageLogInfo	Acquires the specified image logging information.	Refer to <i>Getting the Specified Image Logging Information</i> . (P.A-46).
GetIoModuleIdent	Acquires the identifier name for an I/O module.	Refer to <i>Getting an I/O Module Identifier Name</i> (P.A-47).
GetLanguageIdent	Acquires the language identifier.	---
GetMeasureOut	Acquires the measurement result output yes/no.	*1
GetPort	Executes individual input of parallel I/O terminal states.	*1
GetSceneCount	Acquires the count of usable scenes.	---
GetSceneDescription	Acquires the count of usable scenes.	---
GetSceneGroupCount	Acquires the count of the valid scene groups on the memory card.	---
GetSceneGroupNo.	Acquires the current scene group No.	---
GetSceneGroupTitle	Acquires the scene group title name.	---
GetSceneMaker	Acquires the scene maker name.	---
GetSceneNo	Acquires the current scene No.	---
GetSceneTitle	Acquires the scene title name.	---
GetSecurityParameter	Acquires security related parameters.	Refer to <i>Getting Security Related Parameters</i> (P.A-47).
GetSystemData	Acquires the system data.	*1
GetUnitDataN	Acquires processing unit data.	---
GetUnitDataN2	Acquires processing unit data.	---
GetUnitDataS	Acquires processing unit data.	---
GetUnitDataS2	Acquires processing unit data.	---
GetUnitFigure	Acquires processing unit figure data.	*1
GetUnitItemIdent	Acquires the identifier name for a processing item.	---
GetUnitItemIdent2	Acquires the identifier name for a processing item.	---
GetUnitTitle	Acquires a processing unit title name.	---
GetUnitTitle2	Acquires a processing unit title name.	---
ImageLogging	Executes image logging.	---
ImageUpdate	Updates image data.	*1
InsertUnit	Inserts a processing unit.	*1
IoInitialize	Executes I/O initialization.	Refer to <i>Executing I/O Initialization</i> (P.A-48).
LoadBackupData	Load the System + Scene group data	*1
LoadProc	Executes load processing for unit data.	---
LoadScene	Loads scene data.	*1
LoadSceneGroup	Reads scene group data.	*1
LoadSceneGroup0	Executes load processing for scene group data.	---
LoadSecurityData	Loads security related settings.	Refer to <i>Loading Security Related Settings</i> (P.A-48).
LoadSystemData	Loads system data.	*1
LoadUnitData	Loads processing unit data.	*1
LockMeasureStop	Sets measurement trigger input to disabled.	Refer to <i>Setting Measurement Trigger Input to Disabled</i> (P.A-48).
Measure	Executes measurement processing.	*1
MeasureInit	Executes unit measurement initialization processing.	---
MeasureOut	Executes measurement results display processing.	---
MeasureProc	Executes unit measurement processing.	*1
MeasureStart	Sets measurement trigger input to enabled.	*1
MeasureStop	Sets measurement trigger input to disabled.	*1

Name	Description	References
MeasureStop2	Sets measurement trigger input to disabled.	---
MoveUnit	Moves a processing unit.	*1
NonstopSync	Synchronizes the data for non-stop adjustment settings.	Refer to <i>Synchronizing the Data for Non-Stop Adjustment Settings</i> (P.A-49).
PutAll	Executes batch input of parallel I/O and other terminal states.	*1
PutPort	Executes individual input of parallel I/O and other terminal states.	*1
RaiseOptionEvent	Issues an option event.	*1
ReceiveData	Executes byte type array data input.	*1
Remeasure0	Executes remeasurement processing.	---
Remeasure1	Executes remeasurement processing.	---
RemoveFile	Removes a file or directory.	Refer to <i>Deleting File/Directory</i> (P.A-49).
RenameFile	Changes a file name or directory name.	Refer to <i>File/Directory Name Change</i> (P.A-49).
RenumProc	Executes processing for unit number change.	---
RunOut	Outputs the RUN state.	*1
SaveBackupData	Save the System + Scene Group Data	*1
SaveData	Saves data to the controller.	*1
SaveImage	Executes save processing for image data.	*1
SaveProc	Executes save processing for unit data.	---
SaveScene	Saves scene data.	*1
SaveSceneGroup	Saves scene group data.	*1
SaveSecurityData	Saves security related settings.	Refer to <i>Saving Security Related Settings</i> (P.A-49).
SaveSystemData	Saves system data.	*1
SaveSystemData0	Saves system data.	---
SaveUnitData	Saves processing unit data.	*1
ScreenCapture	Captures the screen.	*1
SendData	Executes byte type array data output.	*1
SendString	Sends a character string.	*1
SetAccessControl	Sets operation restrictions.	Refer to <i>Setting Operation Restrictions</i> (P.A-50).
SetDisplayUnitNo	Sets the specified processing unit number used for image/text display.	*1
SetGlobalData	Sets global data.	*1
SetImageWindow	Sets the image display window.	*1
SetJudgeWindow	Sets the display attributes for the judgment results display window.	Refer to <i>Setting Security Related Parameters</i> (P.A-50).
SetMeasureOut	Sets whether or not measurement results are output.	*1
SetSceneDescription	Sets the scene description.	*1
SetSceneGroupTitle	Sets the scene group title name.	*1
SetSceneMaker	Sets the scene maker name.	*1
SetSceneTitle	Sets the scene title name.	*1
SetSecurityParameter	Sets security related parameters.	Refer to <i>Setting the Measurement Processing Time Display Window</i> (P.A-50).
SetSystemData	Sets the system data.	*1
SetTextWindow	Sets the text display window.	*1
SetTimeWindow	Sets the display attributes for the measurement processing time display window.	Refer to <i>Setting the Measurement Processing Time Display Window</i> (P.A-51).

Name	Description	References
SetUnitDataN	Sets processing unit data.	---
SetUnitDataN2	Sets processing unit data.	---
SetUnitDataS	Sets processing unit data.	---
SetUnitDataS2	Sets processing unit data.	---
SetUnitFigure	Sets the figure data for a processing unit.	*1
SetUnitTitle	Sets a processing unit title name.	*1
SetUserAccount	Sets a user account.	Refer to <i>Setting a User Account</i> (P.A-51).
StartRemoteOperation	Starts remote operation.	---
SyncData	Synchronizes the setting data between Core RA processes.	Refer <i>Synchronization of Setting Data Between CoreRA Processes</i> (P.A-51).
SystemReset	Executes a system reset.	*1
UnLockMeasureStop	Sets measurement trigger input to enabled.	Refer to <i>Setting Measurement Trigger Input to Enabled</i> (P.A-51).
UserLogin	Logs in as the specified user.	Refer to <i>Logging in as the Specified User.</i> (P.A-52).
UserLogout	Logs out.	Refer to <i>Logging Out</i> (P.A-52).

\*1. For details of Operation log input information list, refer to *Macro Command Reference* in the *Vision System FH/FZ5 Series Macro Customize Functions Programming Manual* (Cat. No. Z367).

## Checking Operation Restrictions

---

- CheckAccessControl
- Parameters

name	Operation identifier name
------	---------------------------

- Return value  
For an operation that is not permitted for the logged in user, returns 0.  
For an operation that is permitted for the logged in user, returns value other than 0.

## Clearing the Logging Count Information.

---

- ClearImageLogCount
- Parameters  
None.
- Return value  
If the image logging count is cleared successfully, returns 0.  
Otherwise, returns value other than 0.

## Clearing Security Related Parameters

---

- ClearSecurityData
- Parameters

_userName	User name executed
_password	User password executed
mode	Data to be cleared Bit 0: User account Bit 1: Operation restriction contents Bit 2: Other

- Return value  
If it succeeded, returns 0.  
Otherwise, returns value other than 0.

## Clearing Setting Data in a Batch

---

- ClearSettingData
- Parameters  
None.
- Return value  
If it succeeded, returns 0.  
Otherwise, returns value other than 0.

## Copy File

- CopyFile
- Parameters

srcFileName	Name of file to copy from
destFileName	Name of destination file

- Return value  
If the file is copied successfully, returns 0.  
Otherwise, returns value other than 0.

## Directory Creation

- CreateDirectory
- Parameters

directoryName	Name of directory to create
---------------	-----------------------------

- Return value  
If the directory is created successfully, returns 0.  
Otherwise, returns value other than 0.

## Deleting a User Account

- DeleteUserAccount
- Parameters

_userName	User name executed
_password	User password executed
userName	Name of user to be deleted

- Return value  
If it succeeded, returns 0.  
Otherwise, returns value other than 0.

## Getting Image Density Information

- GetDensityProfile
- Parameters

unitNo	Image input related and image conversion related processing item processing unit number
imageNo	Image number
imageChannel	Image channel number (Specifies RGB, R: 0, G:1, B: 2. For monochrome image, any value is OK)
rectangle	Target rectangular area. The maximum size to acquire density is 4096 pixels. Keep the size to no more than 4096.
profile	Density value storage array Resized when functions are executed.

- Return value  
If the density is acquired successfully, returns 0.  
Otherwise, returns value other than 0.

## Getting an Image Histogram

- GetHistogram
- Parameters

unitNo	Image input related and image conversion related processing item processing unit number
imageNo	Image number
imageChannel	Image channel number (Specifies RGB, R: 0, G:1, B: 2. For monochrome image, any value is OK)
rectangle	Target rectangular area. The maximum size to acquire density is 4096 pixels. Keep the size to no more than 4096.
histogram	Histogram array Resized when functions are executed.

- Return value  
If the density is acquired successfully, returns 0.  
Otherwise, returns value other than 0.

## Getting the Specified Image Logging Information.

- GetImageLogInfo
- Parameters

kind	Type of image logging information to acquire <ul style="list-style-type: none"> <li>• ImageLogMaxCount: Maximum number of images that can be logged in controller memory</li> <li>• ImageLogCount: Count of logging images held in the controller memory</li> </ul>
------	---

- Return value  
Returns the specified image logging information.





## Getting an I/O Module Identifier Name

- GetIoModuleIdent
- Parameters

ioModuleNo	<p>I/O module number</p> <p>0: Registers Parallelo (Parallel I/O). (Fixed)</p> <p>1: Registers any of the following I/O modules in the module communication system.</p> <ul style="list-style-type: none"> <li>• SerialNormal: Serial non-procedure communication</li> <li>• SerialNormal2: Serial non-procedure communication (Fxxx series method)</li> <li>• SerialPlcLink: Serial PLC link (Omron PLC)</li> <li>• SerialPlcLinkM: Serial PLC link (Mitsubishi PLC)</li> </ul> <p>2: Registers any of the following I/O modules for Ethernet communication system</p> <ul style="list-style-type: none"> <li>• TcpNormal: TCP non-procedure communication</li> <li>• UdpNormal: UDP non-procedure communication</li> <li>• UdpNormal2: UDP non-procedure communication (FXXX series method)</li> <li>• UdpPlcLink: UDP PLC link (Omron PLC)</li> <li>• UdpPlcLinkM: UDP PLC link (Mitsubishi PLC)</li> <li>• TcpPlcLink: TCP PLC link (Omron PLC)</li> <li>• TcpPlcLinkM: TCP PLC link (Mitsubishi PLC)</li> </ul> <p>3: Registers one of the following I/O modules or no registration.</p> <ul style="list-style-type: none"> <li>• EtherCAT: EtherCAT communication</li> <li>• EtherNetIP: EtherNet/IP communication</li> </ul>
------------	---

- Return value  
If the I/O module identifier name is acquired successfully (character string), returns 0.  
Otherwise, returns value other than 0.

## Getting Security Related Parameters

- GetSecurityParameter
- Parameters

_userName	User name executed
_password	User password executed
dataIdent	Data identifier name userLoginTimeout: Login timeout time (minutes)
data	Acquisition data storage variable

- Return value  
If it succeeded, returns 0.  
Otherwise, returns value other than 0.

## Executing I/O Initialization

- IoInitialize
- Parameters

ioIdent	Initializing I/O module identifier name <ul style="list-style-type: none"> <li>• Parallelo: Parallel I/O</li> <li>• SerialNormal: Serial non-procedure communication</li> <li>• UdpNormal: Ethernet UDP non-protocol communication</li> </ul>
---------	---

- Return value
  - If the specified I/O is initialized successfully, returns 0.
  - If initialization failed, returns value other than 0.

## Loading Security Related Settings

- LoadSecurityData
- Parameters

_userName	User name executed
_password	User password executed
fileName	Data identifier name userLoginTimeout: Login timeout time (minutes)
data	Path for ID to load

- Return value
  - If it succeeded, returns 0.
  - Otherwise, returns value other than 0.

## Setting Measurement Trigger Input to Disabled

- LockMeasureStop
- Parameters

timeout	Timeout time
---------	--------------

- Return value
  - If it succeeded, returns 0.
  - Otherwise, returns value other than 0.

## Synchronizing the Data for Non-Stop Adjustment Settings

- NonstopSync
- Parameters  
None.
- Return value  
If non-stop adjustment data is synchronized successfully, returns 0.  
Otherwise, returns value other than 0.

## File/Directory Name Change

- RenameFile
- Parameters

oldFileName	Old file/directory name
newFileName	New file/directory name

- Return value  
If the file/directory name was changed successfully, returns 0.  
Otherwise, returns value other than 0.

## Deleting File/Directory

- RemoveFile
- Parameters

pathName	Path name
----------	-----------

- Return value  
If the file/directory is deleted successfully, returns 0.  
Otherwise, returns value other than 0.

## Saving Security Related Settings

- SaveSecurityData
- Parameters

_userName	User name executed
_password	User password executed
fileName	File path to save to

- Return value  
If it succeeded, returns 0.  
Otherwise, returns value other than 0.

## Setting Operation Restrictions

- SetAccessControl
- Parameters

_userName	User name executed
_password	User password executed
name	Operation identifier name
userGroup	User group enabled

- Return value  
If it succeeded, returns 0.  
Otherwise, returns value other than 0.

## Setting Security Related Parameters

- SetJudgeWindow
- Parameters

handle	Handle
locationX	X coordinate of upper left of window
locationY	X coordinate of upper right of window
fontSize	Font size

- Return value  
If the judgment result display window is set successfully, returns 0.  
Otherwise, returns value other than 0.

## Setting the Measurement Processing Time Display Window

- SetSecurityParameter
- Parameters

_userName	User name executed
_password	User password executed
dataIdent	Data identifier name userLoginTimeout: Login timeout time (minutes)
data	Data to set

- Return value  
If it succeeded, returns 0.  
Otherwise, returns value other than 0.

## Setting the Measurement Processing Time Display Window

- SetTimeWindow
- Parameters

handle	Handle
locationX	X coordinate of upper left of window
locationY	X coordinate of upper right of window
fontSize	Font size

- Return value  
If the measurement processing time display window is set successfully, returns 0.  
Otherwise, returns value other than 0.

## Setting a User Account

- SetUserAccount
- Parameters

_userName	User name executed
_password	User password executed
userName	Name of user to be set
userGroupNo	User group number to be set
password	Password to be set

- Return value  
If it succeeded, returns 0.  
Otherwise, returns value other than 0.

## Synchronization of Setting Data Between CoreRA Processes

- SyncData
- Parameters

srcCoreRANo	Source CoreRA number
destCoreRANo	Destination CoreRA number

- Return value  
If setting data between CoreRA processes is synchronized successfully, returns 0.  
Otherwise, returns value other than 0.

## Setting Measurement Trigger Input to Enabled

- UnLockMeasureStop
- Parameters  
None.
- Return value  
If it succeeded, returns 0.  
Otherwise, returns value other than 0.

## Logging in as the Specified User.

---

- UserLogin
- Parameters

userName	User name
password	Password

- Return value  
If it succeeded, returns 0.  
Otherwise, returns value other than 0.

## Logging Out

---

- UserLogout
- Parameters

remoteOperation	Logout target
-----------------	---------------

- Return value  
If it succeeded, returns 0.  
Otherwise, returns value other than 0.

# A-15 Character Code Table

For the case of character related process items, recognized characters are output to an external device using a character code (base 10).

Calculation method for output value (base 10)

Number of upper level bits x 16 + number of lower level bits = output value

(Examples) If the recognized character is "2", "50" is output.

If the recognized character is "C", "67" is output.

Upper 4 bits

		0	1	2	3	4	5	6	7
Lower 4 bits	0		D <sub>E</sub>	SP	0	@	P	`	p
	1	S <sub>H</sub>	D <sub>1</sub>	!	1	A	Q	a	q
	2	S <sub>X</sub>	D <sub>2</sub>	"	2	B	R	b	r
	3	E <sub>X</sub>	D <sub>3</sub>	#	3	C	S	c	s
	4	E <sub>T</sub>	D <sub>4</sub>	\$	4	D	T	d	t
	5	E <sub>Q</sub>	N <sub>K</sub>	%	5	E	U	e	u
	6	A <sub>K</sub>	S <sub>N</sub>	&	6	F	V	f	v
	7	B <sub>L</sub>	E <sub>B</sub>	,	7	G	W	g	w
	8	B <sub>S</sub>	C <sub>N</sub>	(	8	H	X	h	x
	9	H <sub>T</sub>	E <sub>M</sub>	)	9	I	Y	i	y
	A	L <sub>F</sub>	S <sub>B</sub>	*	:	J	Z	j	z
	B	H <sub>M</sub>	E <sub>C</sub>	+	;	K	[	k	{
	C	C <sub>L</sub>	↑	,	<	L	\	l	
	D	C <sub>R</sub>	↓	-	=	M	]	m	}
	E	S <sub>O</sub>	→	.	>	N	^	n	~
	F	S <sub>I</sub>	←	/	?	O	_	o	

# A-16 List for Processing Item Identifier

## ● Measurement

Processing item	Identifier	Processing item	Identifier
Search	Search	Flexible Search	FlexibleSearch
Sensitive Search	SensitiveSearch	ECM Search	EcmSearch
Shape Search II	ShapeSearch2	Shape Search III	ShapeSearch3
Ec Corner	EcCorner	Ec Cross	EcCross
Classification	Classification	Edge Position	EdgePosition
Edge Pitch	EdgePitch	Scan Edge Position	ScanEdgePosition
Scan Edge Width	ScanEdgeWidth	Circular Scan Edge Position	CircularScanEdgePosition
Circular Scan Edge Width	CircularScanEdgeWidth	Intersection	Intersection
Color Data	ColorData	Gravity and Area	ColorArea
Labeling	ColorLabeling	Label Data	LabelData
Defect	Defect	Precise Defect	PreciseDefect
Fine Matching	FineMatching	Character Inspection	CharacterInspect
Date Verification	DateVerification	Model Dictionary	ModelDictionary
2DCode II	2dcr2	2DCode	2dcrV400
Barcode	BarcodeCC	OCR User Dictionary	CharacterDictionary
OCR	CharacterRecognition	Circle Angle	CircleAngle
Glue Bead Inspection	EmbrotationTrack		

## ● Input image

Processing item	Identifier	Processing item	Identifier
Camera Image Input	CameraImage	Camera Image Input	CameraImageFH
Camera Image Input FHV	CameraImageFHV	FH	
Camera Image Input HDR	CameraImageHDR	Camera Image Input HDR Lite	CameraImageHDRLite
Photometric Stereo Image Input	CameraImagePS	Camera Switching	CameraSwitch
Measurement Image Switching	MeasureImageSwitch	Multi-Trigger Imaging	MultImaging
*Multi-Trigger Imaging End	MultImagingEnd	Multi-Trigger Imaging Task	MultImagingTask

Note An item with\* in the head is not displayed.

## ● Compensate image

Processing item	Identifier	Processing item	Identifier
Position Compensation	Scroll	Filtering	Filtering
Background Suppression	FilterHighContrast	Brightness Correct Filter	FilterShading
Color Gray Filter	FilterColorGray	Extract Color Filter	FilterExtractColor
Anti Color Shading	FilterEven	Stripes Removal Filter II	FilterRank
Polar Transformation	TransPolar	Trapezoidal Correction	TrapezoidalCorrection2
Machine Simulator	MachineSimulator	Image Subtraction	DifferenceExtract
Advanced filter	FilterAdvanced	Panorama	Panorama2



● **Support measurement**

Processing item	Identifier	Processing item	Identifier
Unit Macro	Macro	Unit Calculation Macro	MacroCalc
Calculation	Calculation	Line Regression	ApproximateLine
Circle Regression	ApproximateCircle	Precise Calibration	CalibrationP
User Data	UserData	Set Unit Data	SetUnitData
Get Unit Data	GetUnitData	Set Unit Figure	SetUnitFigure
Trend Monitor	TrendMonitor	Image Logging	ImageLogging
Image Conversion Logging	MeasureImageSave	Data Logging	DataLogging
Elapsed Time	ElapsedTime	Wait	Wait
Focus	SettingFocus	Iris	SettingBright
Parallelize	Parallelize	*Parallelize End	ParallelizeEnd
Parallelize Task	ParallelizeTask	Statistics	Statistics
Calibration Data Reference	ReferenceCalibData	Position Data Calculation	SetPositionData
Stage Data	StageData	Robot Data	RobotData
Vision Master Calibration	AlignmentCalibration	PLC Master Calibration	AlignmentCalibrationPLC
Transfer Position Data	ScrollPositionData	Calc Axis Move	ScrollCalculation
Calc Axis Move by Multipoint	ScrollCalculationMulti	Detection Point	DetectionPoint
Manual Position Setting	ForcePositionSetting	Camera Calibration	CameraCalibration
Data Save	DataSave	Conveyor Calibration	ConveyorCalibration
Scene	Scene	System information	SystemInfo

Note An item with\* in the head is not displayed.

● **Branch**

Processing item	Identifier	Processing item	Identifier
Conditional Branch	Branch	End	End
DI Branch	InputBranch	Control Flow Normal	ControlFlowStringCommand
Control Flow PLC Link	ControlFlowPlcLinkCommand	Control Flow Parallel	ControlFlowParallelCommand
Control Flow Fieldbus	ControlFlowFieldbusCommand	Conditional execution (If)	If
Conditional execution (Else)	IfElse	*Condition execution end	IfEnd
Loop	Loop	Loop suspension	LoopExit
*End loop	LoopEnd	Select execution (Select)	Select
Select execution (Case)	SelectCase	*End selection execution	SelectEnd

Note An item with\* in the head is not displayed.

● **Output result**

Processing item	Identifier	Processing item	Identifier
Result output (I / O)	OutputIO	Result output (Message)	OutputString
Data Output	NormalData	Parallel Data Output	ParallelData
Parallel Judgement Output	ParallelJudge	Fieldbus Data Output	FieldbusData

● **Output result**

Processing item	Identifier	Processing item	Identifier
Result Display	ResultDisplay	Display Image File	DisplayImageFile
Display Last NG Image	DisplayLastNG	Conveyor Panorama Display	ConveyorPanorama
Display image hold	DisplayImage		

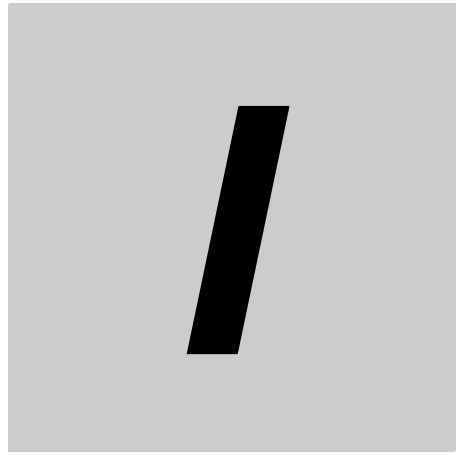

# Index



# Index

---

- A**
- 
- Account list ..... 10-29
  - Add button ..... 8-28
  - Adding Accounts ..... 10-29
  - Adding variables ..... 5-44
  - Adding Window Parts ..... 8-22
  - Addition of window parts ..... 8-19
  - Alignment ..... 10-60
  - Alignment Function ..... 10-49
  - Analyzing Logged Data ..... 6-22
  - Angle Range ..... A-13
  - Applicable Line Maintenance settings data ..... 9-34
  - Application memory ..... A-29
  - Apply immediately ..... 9-44
  - Applying Copy/Clear Operations ..... 9-42
  - Arc ..... 3-20
  - Assigning variables ..... 5-61
  - Automatic Parallelization ..... 4-29
  - Automatic parallelization ..... 4-29
  - Available application memory ..... 3-29
  - Available data memory ..... 3-29
- B**
- 
- Base Configuration ..... 3-3
  - BMP(BFZ) ..... 3-11, 6-15
  - BMP(BFZ) file type ..... A-20
  - Button size ..... 8-28
  - Buttons/columns ..... 8-28
- C**
- 
- Calculating the Measuring Interval ..... 6-20
  - Calibration ..... A-19
  - Camera Connection ..... 4-39
  - CameraLink medium configuration ..... 3-4
  - CameraLink standard ..... 3-2, 3-3
  - Candidate Point Level ..... A-13
  - Captured Image Files ..... 3-33
  - Character code ..... 4-64
  - character string ..... 5-60
  - Character type mix required settings ..... 10-32
  - Checking Variables ..... 5-64
  - Circle/Ellipse ..... 3-18
  - Circumference ..... 3-19
  - Clear logging image ..... 6-41
  - Clear measurement ..... 6-41
  - Clearing setting data ..... 9-41
  - Clearing the Error Display ..... 8-36
  - Common setting ..... 4-44
  - Configuration Copy ..... 9-18
  - Connection cable for FH-MT12 ..... 4-9
  - Continuous meas. .... 6-3
  - Control box ..... 8-18
  - Copy files ..... 9-12
  - Copy Setting data ..... 9-39
  - Correlation Value ..... A-13
  - CR ..... A-12
  - Crosshair Cursor ..... 3-21
  - Custom Dialog Functions ..... 8-67
- D**
- 
- Data grid ..... 8-41
  - Data Logging ..... 6-9
  - Data memory ..... A-29
  - Data to be saved ..... 9-10
  - Date-time setting ..... 4-47
  - Define displayed unit ..... 3-24
  - Delay between Cameras ..... 4-40
  - Delay count between STEP-cameras ..... 4-41
  - Delete button ..... 8-28
  - Deleting an Account ..... 10-31
  - Deleting Window Parts ..... 8-22
  - Depends on language mode ..... 4-64
  - Detail Result Pane ..... 8-7
  - Device Information Storage Tool ..... 3-35
  - Difference in Touch Panel Monitor Communications ... 4-11
  - Differential ..... A-15
  - Display image transfer size  
     (Size of the image to transfer) ..... 10-11
  - Display ratio ..... 3-24
  - Display Type ..... 4-63
  - Displaying Multiple Images Aligned at Even Interval ... 8-34
  - DLL name ..... 8-19
  - Don't show the title bar ..... 8-18
  - Double ..... 5-45
  - Double array ..... 5-45
  - Double Speed Multi-input ..... 4-12, 4-15, 4-32
  - Double speed Multi-input ..... 9-15
  - Double Speed Multi-input mode ..... 4-14
  - Drive information ..... 3-28
- E**
- 
- Edge Detection Method ..... A-15
  - Edge Level ..... A-16
  - Edit Flow Tab Screen ..... 5-15
  - Edit item tab area ..... 5-20
  - Editing a Normal Dialog Box ..... 8-73
  - Editing a Template ..... 9-22
  - Editing an Account ..... 10-30
  - Editing Comments of a Variable ..... 5-56
  - Editing Number of Elements of  
     an Array Type Variable ..... 5-48
  - Editing the Initial Value of a Variable ..... 5-49
  - Editing Values ..... 5-52
  - Elapsed Time ..... 6-7

Enable timing .....	4-52
Encoder input type .....	4-51
Encoder trigger setting .....	4-51
Error Setting .....	4-62
ERROR Signal Output .....	4-63
Error Type .....	4-63
Execute batch measurement .....	6-33
executing alignment .....	10-60
Executing Calibration .....	10-55
Exiting Layout Modification Mode .....	8-24
Extended window parts .....	8-40
External Tool List .....	A-5, A-6

## F

File type .....	6-15
Filtering variables .....	5-59
Firmware upgrade .....	3-30
Fit to the grid line .....	8-19
Fix the position .....	8-18
Fixing the Aspect Ratio of the Image Pane .....	8-34
Flow Builder .....	5-11
Flow Display Pane .....	8-7
Flow of Images .....	4-33
Flow Viewer .....	5-10
Format .....	9-48
Format Setting .....	8-42
Freeze .....	3-24
FTP .....	6-24

## G

Grid interval .....	8-19
---------------------	------

## H

Handling Coordinates .....	A-19
High-speed Logging mode .....	4-14

## I

IFZ .....	6-15
IFZ file type .....	A-20
Image .....	3-24
Image (MB) .....	3-29
Image Conversion Logging .....	6-9
Image Logging .....	6-8
Image Mode .....	3-25
Image Pane .....	8-7
Image window number .....	8-32
Information Pane .....	8-6
Integer .....	5-45
Integer array .....	5-45
Item Properties Display Area .....	8-76

## J

JPG(JFZ) .....	6-15
JPG(JFZ) file type .....	A-21
Judgement Pane .....	8-5

## K

Keyboard Layout Selection Tool .....	10-44
--------------------------------------	-------

## L

Language Setting .....	4-2
Last NG .....	3-24, 3-26
Launching the Line Maintenance tool .....	9-36
Layout Functions .....	8-14
Layout number .....	8-18
Layout restrictions .....	10-33
Layout setup .....	8-25
LCD off .....	3-41
Limiting the Number of Image Panes Assignable to	
Each Layout .....	8-32
Line .....	3-17
Line Maintenance .....	9-32
Line Maintenance Screen Layout .....	9-35
Line setting .....	4-45
Load from file .....	9-13
Logging .....	6-17
Logging Current Image .....	6-10
Logging priority .....	6-17
Logging Setting .....	6-11
Logout .....	10-46

## M

Macro specification .....	8-42
Macro/Variable function setting .....	4-64
Manual Parallelization .....	4-30
Manual parallelization .....	4-29
Matching character string .....	5-59
Maximized .....	8-18
Measurement .....	6-17
Measurement initialization priority .....	4-4
Measurement Manager Bar .....	3-31
Measurement Pane .....	8-6
Measurement priority .....	4-4
Measurement Processing .....	2-2
Measurement settings .....	4-58
Medium Configuration .....	3-3
Memories Usable .....	A-29
Memory state .....	3-28, 3-31
Menu bar .....	5-21
Menu List .....	A-2
Minimum password string set .....	10-32
Mode .....	10-21
Multi line random trigger .....	4-12
Multi-input .....	10-21
Multi-input Function .....	4-16
Multi-line Random trigger .....	4-32

Multi-line Random-trigger .....	9-15
Multi-line Random-trigger Mode .....	4-19
Multi-line Random-trigger mode .....	4-14
Multiple image logging .....	6-16
Multiple selection .....	5-8, 5-32
Multi-trigger Imaging .....	10-15

## N

---

Nesting .....	4-34
Network Drive Function .....	6-26
Network drive setting .....	6-26
Network drive settings .....	4-53
NG (memory shortage) .....	11-10
No operation logout area .....	10-31
Noise Level .....	A-17
Noise Width .....	A-17
Non-Multi-input .....	10-21
Non-operate time .....	10-31
Non-stop Adjustment .....	4-32, 9-15
Non-stop adjustment .....	4-12
Non-stop Adjustment Mode .....	4-25
Non-stop Adjustment mode .....	4-14
Non-stop data transfer .....	4-26
Normal (Fxxx Series Method) .....	4-7
Normal communications method .....	4-7
NOT setting .....	3-23
number of application process .....	3-29
Number of Images That Can Be Saved .....	6-19

## O

---

OK Responses .....	4-7
On-board memory .....	A-29
Operation log setting .....	10-40
Operation Mode .....	4-13
Operation mode .....	4-12, 4-14
Operation priority .....	4-4
Optimize the button .....	8-28
OR setting .....	3-23
Other Alignment Functions .....	10-63
Output .....	6-3, 8-26
Output condition for output signal .....	8-26
Output Coordinates .....	A-19
Output signal .....	4-44
Output Signal Setting .....	4-43
Output without a Camera connection .....	4-44

## P

---

Parallel execution .....	4-12
Password advanced settings .....	10-32
Password expiration period setting .....	10-32
Perform transparency processing .....	8-23
Phase A trigger .....	4-52
Physical memory .....	3-29
PLC link error .....	11-6
Polygons .....	3-21
Position .....	3-24

Processing Images (Filtering) .....	6-6
Processing Item Logging .....	6-8, 6-9
Processing Order .....	4-34
Procltem error .....	11-5
Projection (Density method) .....	A-15
PT .....	A-12
Pulse reset timing .....	4-52

## Q

---

Quality .....	6-15, 9-49
---------------	------------

## R

---

RAMDisk .....	A-29
Reconnect .....	4-53
Rectangle .....	3-17
Referencing another Scene's Flow .....	5-33
Registered Image Manager .....	6-42
Registering an Image File (Bitmap) such as a Logo ....	8-37
Relocate memories .....	4-4
Remaining variable definitions .....	5-22
Remeasurement .....	6-27
Re-measurement results statistics .....	6-31
Remeasuring Saved Images .....	6-27
Remote Operation .....	10-3
Resolution pulse/rotation .....	4-51
Restore the default setting .....	8-19
Restoring a Layout to its Default Settings .....	8-24
Right-click Menu 1 .....	8-20
Right-click Menu 2 .....	8-21
rotation speed .....	4-49
RUN signal out .....	8-26

## S

---

save file name .....	9-11
Save Last Logging Image .....	6-10
Save scene group on switch scene .....	7-5
Save to file .....	9-10
Saving the Layout as a file .....	8-25
Saving the Layout in the Controller .....	8-25
Saving to an External Storage Device .....	9-21
Scene .....	5-2
Scene data (*.scn) .....	9-8
Scene group data (*.sgp) .....	9-8
Scene Group Saving Destination Setting .....	7-10
Scene maintenance .....	7-6
Scene variable list .....	5-22
Scene Variable Tab Screen .....	5-20
Screen capture setting .....	3-32
Screen keyboard .....	3-7
Search Detection Method .....	A-12
Search Speed .....	A-12
Security Settings .....	10-29
Select dialog .....	8-70
Selecting an Image File (Bitmap) such as a Logo .....	8-38
Setting Automatic Logout .....	10-31
Setting data which can be backed up .....	9-16

Setting Logging Conditions .....	6-11
Setting parameters of Multi-trigger Imaging	
Processing Items .....	10-21
Setting Password Advanced Settings .....	10-32
Settings download and upload tools .....	9-51
Settings for Position Alignment .....	10-62
Settings for the Calibration To Execute .....	10-54
Settings for the External Device to Use .....	10-53
Settings for Touch Panel Monitor .....	4-8
Setup Setting .....	8-49
Share name .....	4-55
Shared folder .....	4-53, 4-55
Shift Area .....	5-8
Shift area .....	6-37
Showing Grid .....	8-34
SHTOUT signal delay .....	4-45
SHTOUT signal pulse polarity .....	4-45
SHTOUT signal pulse width .....	4-45
Simplified Non-stop Adjustment Mode .....	6-35
Single-line High speed mode .....	4-14
Skipping Angle .....	A-13
Standard .....	9-15
Standard (Operation Mode) .....	4-28
Standard (Operation mode) .....	4-32
Standard mode .....	4-14
Startup Layout .....	8-4
Startup layout .....	4-3
Startup setting .....	4-3
STEP in measure .....	4-58
STEP signal filter width .....	4-50
Steps for Operating with Functional Limitations .....	9-44
STGOUT setting .....	4-44
string .....	5-45
String array .....	5-45
System + Scene group 0 data (*.bkd) .....	9-8
System data (*.ini) .....	9-8
System Logging .....	6-8, 6-9, 6-10
System Settings .....	1-4
System Variable Tab Screen .....	5-22

## T

---

TDM Editor .....	5-14
Text .....	3-22
the alignment flow .....	10-60
The judgment result monitor .....	6-28
Through .....	3-24, 3-26
Time .....	3-22
Timeout .....	10-22
To add image windows .....	8-32
Toolbox Pane .....	8-6, 8-28
Top menu display .....	8-18
Transmission speed .....	4-41
Transparent color .....	8-23
type of the variable .....	5-45
types of dialog boxes that you can create .....	8-69

## U

---

Unicode (UTF-8) .....	9-52
Unit (MB) .....	3-29
Unit + Image Inclusive sum .....	3-29
Unit No. .....	3-24, 8-32
Unit setting mode .....	8-31
Update Standard Position Tool .....	6-38
User group ID .....	10-30
UTF-8 .....	4-64

## V

---

Variable button area .....	5-20
Virtual Available (MB) .....	3-29

## W

---

What Is Logging? .....	6-8
When Setting a Transparent Color to	
Window Objects .....	8-23
Window Parts .....	8-15
Window parts list .....	8-20







**OMRON Corporation Industrial Automation Company**  
Kyoto, JAPAN

Contact: [www.ia.omron.com](http://www.ia.omron.com)

**Regional Headquarters**

**OMRON EUROPE B.V.**

Wegalaan 67-69, 2132 JD Hoofddorp  
The Netherlands  
Tel: (31)2356-81-300/Fax: (31)2356-81-388

**OMRON ELECTRONICS LLC**

2895 Greenspoint Parkway, Suite 200  
Hoffman Estates, IL 60169 U.S.A.  
Tel: (1) 847-843-7900/Fax: (1) 847-843-7787

**OMRON ASIA PACIFIC PTE. LTD.**

No. 438A Alexandra Road # 05-05/08 (Lobby 2),  
Alexandra Technopark,  
Singapore 119967  
Tel: (65) 6835-3011/Fax: (65) 6835-2711

**OMRON (CHINA) CO., LTD.**

Room 2211, Bank of China Tower,  
200 Yin Cheng Zhong Road,  
PuDong New Area, Shanghai, 200120, China  
Tel: (86) 21-5037-2222/Fax: (86) 21-5037-2200

**Authorized Distributor:**

© OMRON Corporation 2016-2018 All Rights Reserved.  
In the interest of product improvement,  
specifications are subject to change without notice.

**Cat. No. Z365-E1-05**

1118