

Emergency Stop Pushbutton Switches

A22NE-PD/A22NE-P/A22E Series

Securing Greater Safety

A variety of functions for enhanced safety and mounting efficiency



Basic:
Screw Terminal Block Types
A22E Series



Vibration-resistant:
Push-In Plus Terminal Block Types
A22NE-P Series



NEW
Push-In Plus Terminal Block +
Lock-lever-linked Contact Types
A22NE-PD Series

Machines Are Designed to Stop Without Fail.

An emergency stop pushbutton switch stops machine equipment in an emergency to protect the safety of workers.

However, if the switch does not function properly due to human error, malfunction, defective wiring or other reasons, it will lead to a major accident. That is why Omron has focused on stopping machines without fail and produced a lineup of emergency stop switches with enhanced functionality.



>> Three Functions to Enhance Reliability



Lock-lever-linked Contacts

Stops machines when a Switch is improperly mounted.

- Cuts off the current when the lock lever is off.
- Instantly detects work errors and lever damage.

Refer to page **4** for details.



Push-In Plus Terminal Block

Reduces loose and detached wiring.

- Wires are resistant to vibration and do not come off easily.
- Reduces work for wiring and maintenance.

Refer to page **5** for details.



Optional IP69K

Stable operation in harsh environments.

- Usable up to 80°C and pressures of 80 to 100 BAR.
- Spray-resistant on the front and sides.

Refer to page **5** for details.



A Lineup That Allows You to Choose According to Your Needs

Fully-loaded with Three Functions

A22NE-PD Series

Page 7



Easy and Reliable Push-In Plus Terminal Block

A22NE-P Series

Page 21



Basic Screw Terminal Block

A22E Series

Page 37



Accident Prevention/Stable Operation

Suppress Malfunctions Thoroughly with Functions for Various Applications.



Lock-lever-linked Contacts

A22NE-PD Series

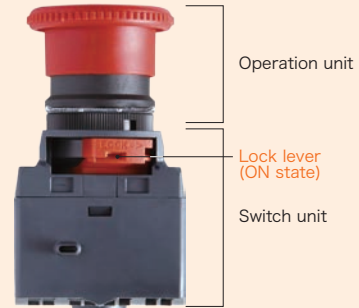

Detects Improper Installations for Zero Malfunction Problems During Emergencies

If the sliding operation of the lock lever is insufficient, the operation unit may not function properly when needed, even if pushed. With the lock-lever-linked contact function, if the sliding operation of the lock lever is insufficient, the original NC contact will turn to a NO state when the operation unit is not pushed, making it possible to detect errors from the state of the contact.

Lock lever OFF

The contact* opens and the current is cutoff.

Machine equipment stops.

Lock lever ON

The contact* closes and the current flows.

Machine equipment operates.

* The example shows an NC contact. However, all contacts are interlocked with the lock lever, and the statuses of NO contacts are also switched.

For machine equipment that can cause major accidents

Ensures additional safety for machine equipment that cannot afford a slight delay.





Push-In Plus Terminal Block

A22NE-PD/A22NE-P Series

Prevents Loose and Detached Wiring Caused by Vibration During Operation

In addition to preventing unexpected stoppages caused by disconnection, it is also possible to reduce maintenance efforts.

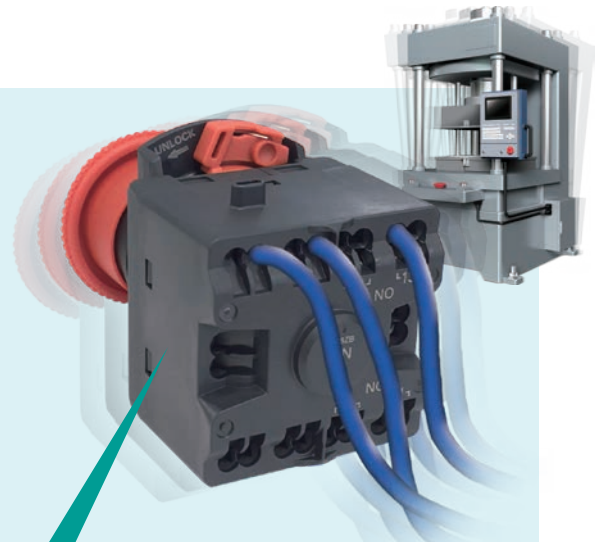

Also help reduce the wiring work

Just insert wires like you would into an earphone jack. No tools are required.

They help reduce the time and work involved in wiring.



IEC standard (Cable diameter)	Push-In Plus Terminal Block	Screw Terminal Block
20 N min (AWG20, 0.5 mm ²)	125 N	112 N

* Information for Push-In Plus Terminal Blocks and screw terminal blocks is based on OMRON's actual measurement value data for the XW2R.



Optional IP69K

A22NE-PD/A22NE-P Series

High-level Sealing that Is Resistant to Harsh Environments

Conventional OMRON emergency stop pushbutton switches were made to IP65 standards, but the unique technology used for our rubber-designed covers achieves IP69K specifications that can withstand high-temperature and high-pressure sprays from any direction.

High temperature: **80°C**
High pressure: **80 to 100 BAR**



For sites that demand high-level sanitation control

Withstands high-temperature and high-pressure sprays without the need for an additional waterproof cover, allowing for worry-free installation in sites where cleaning with high-pressure washing machines is performed.



Emergency Stop Pushbutton Switches (22-dia. or 25-dia.) A22NE-PD/A22NE-P/A22E

A22NE-PD

Install in 22-dia. or 25-dia.

Panel Cutout (When Using a Ring)

- Direct opening mechanism to open the circuit when the contact welds.
 - With a latching mechanism to prevent operating errors.
 - Lock lever for easily mounting and removing the Unit.
 - Use 25-dia. ring to install in 25-dia. panel cutouts. *
 - In a model equipped with Lock-lever-linked contact function, the improper installation of the Switch Unit can be detected. (A22NE-PD)
- * Switches with an IP69K degree of protection do not support the 25-dia.

A22NE-P

 Be sure to read the "Safety Precautions" on pages 17, 33, 50, and 56.

A22E

Push-in Plus
Terminal Block Types

With Lock-lever-linked contact function
A22NE-PD

Page 7



Without Lock-lever-linked contact function
A22NE-P

Page 21



Common
Accessories and Tools

Screw Terminal
Block Types

Without Lock-lever-linked contact function
A22E

Page 37

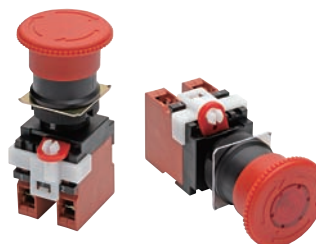

Common
Note

A22NE-PD

Install in 22-dia. or 25-dia. Panel Cutout

(When Using a Ring)

- The small size of the control panel is realized by conserving space and changing the direction of the wiring.
- Since there is no looseness in the wiring, there is a reduction in the maintenance efforts.
- A maximum of up to four contact points can be combined together in the contact-point configuration.
- Oil-resistant to IP65 (non-lighted models) / IP65 (lighted models) / IP69K high-temperature, high-pressure cleaning (pull-reset models).
- Whether or not the Operation Unit and the Switch Unit have been properly mounted can be detected from the open/closed state of the contact (Lock-lever-linked contact function). *
- * All contacts are interlocked with the lock lever.
(The statuses of both NC contacts and NO contacts are switched.)



For the most recent information on models that have been certified for safety standards, refer to your OMRON website.

Be sure to read the "Safety Precautions" on pages 17 and 56.

Model Number Structure

Model Number Legend (Completely Assembled) Shipped as a set which includes the Operation Unit, LED Lamp (lighted models only), and Switch Block.



1. Operation Unit size (diameter)

Code	Description
S	30 dia.
M	40 dia.
L	60 dia.

2. Reset function

Code	Description
None	Turn-reset
P	Pull-reset *

* The pull-reset type is only available on the 40 dia. Operation Unit, non-lighted type. Not available on lighted types.

3. Terminal specification

Code	Description
P	Push-in plus terminal block

4. Lock lever function

Code	Description
D	Lock-lever-linked contact function

5. Contacts

Code	Number of Contacts	Contacts	
		NO	NC
01	one contact	0	1
02	two contacts	0	2
11		1	1
03	three contacts	0	3
21		2	1
12	four contacts	1	2
22		2	2
13	four contacts	1	3
04		0	4

Note. NO: 1a-contact NC: 1b-contact

6. LED lamp voltage

Code	Description
N	Non-lighted
C	24 VAC/VDC

* Lighting color is red.

7. Others (Degree of Protection)

Code	Description
None	IP65
69K	IP69K *

* IP69K is supported only by the Pull-reset models.

A22NE-PD

A22NE-P

A22E

Common Accessories and Tools

Common Note

Ordering Information

List of Models (Completely Assembled)

Non-lighted Models (Without EMO/EMS Indication)

Appearance	Operation	Degree of Protection	Contact configuration *	Set Model	Color of cap
	40-dia. head Medium Pull-reset A22NE-MP-PD□□-N	IP65 oil-resistant models	2NC	A22NE-MP-PD02-N	Red
			2NC, 1NO	A22NE-MP-PD12-N	
			3NC	A22NE-MP-PD03-N	
			2NC, 2NO	A22NE-MP-PD22-N	
			3NC, 1NO	A22NE-MP-PD13-N	
4NC	A22NE-MP-PD04-N				
	40-dia. head Medium Pull-reset A22NE-MP-PD□□-N-69K	IP69K	2NC	A22NE-MP-PD02-N-69K	
			2NC, 1NO	A22NE-MP-PD12-N-69K	
			3NC	A22NE-MP-PD03-N-69K	
			2NC, 2NO	A22NE-MP-PD22-N-69K	
			3NC, 1NO	A22NE-MP-PD13-N-69K	
4NC	A22NE-MP-PD04-N-69K				
	30-dia. head Small Turn-reset A22NE-S-PD□□-N	IP65 oil-resistant models	2NC	A22NE-S-PD02-N	
			2NC, 1NO	A22NE-S-PD12-N	
			3NC	A22NE-S-PD03-N	
			2NC, 2NO	A22NE-S-PD22-N	
			3NC, 1NO	A22NE-S-PD13-N	
4NC	A22NE-S-PD04-N				
	40-dia. head Medium Turn-reset A22NE-M-PD□□-N	IP65 oil-resistant models	2NC	A22NE-M-PD02-N	
			2NC, 1NO	A22NE-M-PD12-N	
			3NC	A22NE-M-PD03-N	
			2NC, 2NO	A22NE-M-PD22-N	
			3NC, 1NO	A22NE-M-PD13-N	
4NC	A22NE-M-PD04-N				
	60-dia. head Large Turn-reset A22NE-L-PD□□-N	IP65 oil-resistant models	2NC	A22NE-L-PD02-N	
			2NC, 1NO	A22NE-L-PD12-N	
			3NC	A22NE-L-PD03-N	
			2NC, 2NO	A22NE-L-PD22-N	
			3NC, 1NO	A22NE-L-PD13-N	
4NC	A22NE-L-PD04-N				

* In addition to the above, we also provide the following contact configurations: [1NC], [1NC, 1NO], and [1NC, 2NO]. Ask your OMRON representative for details.

Lighted Model (Without EMO/EMS Indication)

Appearance	Operation	Degree of Protection	Contact configuration *	LED lamp voltage	Set Model	Color of cap
	40-dia. head Medium Turn-reset A22NE-M-PD□□-C	IP65	2NC	24 V AC/DC	A22NE-M-PD02-C	Red
			2NC, 1NO		A22NE-M-PD12-C	
			3NC		A22NE-M-PD03-C	
			2NC, 2NO		A22NE-M-PD22-C	
			3NC, 1NO		A22NE-M-PD13-C	
			4NC		A22NE-M-PD04-C	

* In addition to the above, we also provide the following contact configurations: [1NC], [1NC, 1NO], and [1NC, 2NO]. Ask your OMRON representative for details.

A22NE-PD

A22NE-P

A22E







Common Accessories and Tools

Common Note

Accessories (Order Separately)

Operation Unit

Non-lighted

Function	Degree of protection	Size	Single item order model	
		Small (30 dia.)	Medium (40 dia.)	Large (60-dia.)
Pull-reset	IP65 oil-resistant models	---	A22NE-MP-N 	
	IP69K	---	A22NE-MP-N-69K 	
Turn-reset	IP65 oil-resistant models	A22NE-S-N 	A22NE-M-N 	A22NE-L-N 
			A22NE-MRO-N A22NE-MRO-N-RD 	
			A22NE-MRS-N A22NE-MRS-N-RD 	

Lighted

Function	Sealing capability	Size	Single item order model
		Medium (40 dia.)	
Turn-reset	IP65		A22NE-M-L 

LED lamp

Appearance	LED light	Rated voltage	Model	Remarks
	Red	24 V AC/DC	A22NZ-L-RC	These are provided with the completely assembled set of lighted models. Order LED Lamps only when replacing them.

Note: For details on the accessories common to the screw terminal block models and push-in plus terminal block models, refer to "Common Accessories and Tools (Order Separately)" on page 51.

A22NE-PD

Specifications

Certified Standard Ratings

- UL508 (File No. E76675), CSA C22.2 No.14
5 A at 125 VAC, 3 A at 250 VAC B300
- TÜV (EN60947-5-1) - Certified direct opening -
(EN60947-5-5)
AC-15 3 A at 125 VAC
DC-13 1 A at 30 VDC
- CCC (GB14048.5)
AC-15 3 A at 125 VAC
DC-13 1 A at 30 VDC

Applicable Standards

UL1059, UL486E

Note: Use a 10 A fuse type gI or gG that conforms to IEC60269 as a short-circuit protection device. This fuse is not provided in the main unit.

Ratings

Contacts (Standard Load)

Rated insulation voltage (V)	Rated carry current (A)	Rated voltage (V)	Rated current (A)			
			AC15 (Inductive load)	AC12 (Resistive load)	DC13 (Inductive load)	DC12 (Resistive load)
250	5	30 VAC	---	---	---	---
		125 VAC	3 A	5 A	---	---
		250 VAC	1.5 A	3 A	---	---
		30 VDC	---	---	1 A	2 A
		125 VDC	---	---	0.22 A	0.4 A
		250 VDC	---	---	0.1 A	0.2 A

- Note: 1.** The above ratings were obtained by conducting tests under the following conditions.
 (1) Ambient temperature: 20 \pm 2 $^{\circ}$ C
 (2) Ambient humidity: 65 \pm 5%
 (3) Operating frequency: 20 operations/minute
- 2.** Minimum applicable load: 1 mA at 5 VDC (Resistive load)
 The operating range may vary depending on the usage conditions and type of load.

Certified Standards

Certification body	Standards	File No.
UL *	UL508, C22.2 No.14	E76675
TÜV SÜD	EN60947-5-1 (Certified direct opening), EN60947-5-5	Consult your OMRON representative for details.
CQC (CCC)	GB14048.5	Consult your OMRON representative for details.

Note: Only models with NC contacts have a direct opening mechanism.

* UL-certification for CSA C22.2 No. 14 has been obtained.

LED Lamp (A22NZ-L-RC)

Rated voltage	Operating voltage	Current value
24 VAC/VDC	24 VAC/VDC \pm 10%	Approx. 12 mA

A22NE-PD

A22NE-P

A22E

Common Accessories and Tools

Common Note

Characteristics

Operation		Turn-reset		Pull-reset	
		Non-lighted model	Lighted Model	Non-lighted model	Non-lighted model (Models with IP69K)
Item		A22NE-□-PD□□-N-□	A22NE-M-PD□□-C-□	A22NE-MP-PD□□-N-□	A22NE-MP-PD□□-N-69K
Allowable operating frequency	Mechanical	30 operations/minute or less (One operation consists of set and reset operations.)			
	Electrical	30 operations/minute or less (One operation consists of set and reset operations.)			
Insulation resistance *1		100 MΩ min. (at 500 VDC)			
Contact resistance		100 mΩ max. (initial value)			
Dielectric strength	Between terminals of same polarity*1	2,000 VAC, 50/60 Hz 1 minute (initial value)			
	Between terminals of different polarity	2,000 VAC, 50/60 Hz 1 minute (initial value)			
	Between each terminal and ground	2,000 VAC, 50/60 Hz 1 minute (initial value)			
Vibration resistance	Malfunction	10 to 55 Hz, 1.5 mm double amplitude (contact separation within 1 ms)			
Shock resistance	Malfunction	250 m/s ² max. (contact separation within 1 ms)			
Durability	Mechanical	300,000 operations min. (One operation consists of set and reset operations.)			100,000 operations min. (One operation consists of set and reset operations.)
	Electrical (100 mA at 24 VAC (Resistive load))	250,000 operations min. (One operation consists of set and reset operations.)			100,000 operations min. (One operation consists of set and reset operations.)
	Electrical (3 mA at 250 VAC (Resistive load))	100,000 operations min. (One operation consists of set and reset operations.)			
Ambient operating temperature *2		-20 to +70°C	-20 to +55°C	-20 to +70°C	-20 to +70°C *3
Ambient operating humidity		35 to 85% RH			
Ambient storage temperature *2		-40 to +70°C			
Degree of protection *4		IP65 oil-resistant models	IP65	IP65 oil-resistant models	IP69K
Electric shock protection class		Class II			
PTI (tracking characteristic)		175			
Degree of contamination		3 (EN 60947-5-1)			
Minimum direct opening stroke		11 mm			
Minimum direct opening force		45 N			
Conditional short-circuit current		100 A (EN 60947-5-1)			
Wight (for a 40-dia. head 2NC/2NO Operation Unit)		Approx. 95 g	Approx. 95 g	Approx. 125 g	Approx. 135 g

*1. State when an LED is not added between terminals of the same polarity on a lighting unit.

*2. With no icing or condensation.

*3. Capable of operation at up to 80°C under IP□9K testing conditions per JIS D 5020.

*4. The degree of protection from the front of the panel.

Operating Characteristics

Item	Turn-reset	Pull-reset	
	Lighted / non-lighted models	Non-lighted model	Non-lighted model (Models with IP69K)
Total travel force (TTF)	45 N max.	60 N max.	70 N max.
Return force (RF)	0.25N·m max. *	60 N max.	70 N max.
Total travel (TT)	10 ±1 mm	5.5 ±1 mm	

* Rotation torque value.

Terminal Arrangement (BOTTOM VIEW)

Non-lighted

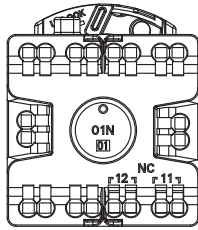

One contact (1NC)

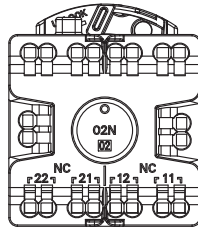

Two contacts (2NC)

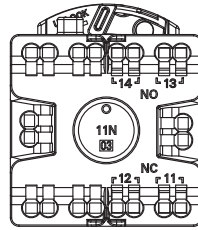

Two contacts (1NC + 1NO)

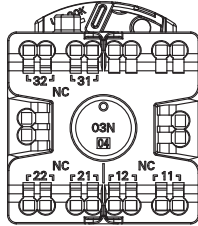

Three contacts (3NC)

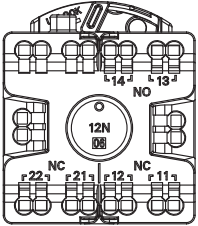

Three contacts (2NC + 1NO)

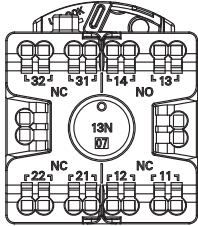

Four contacts (3NC + 1NO)

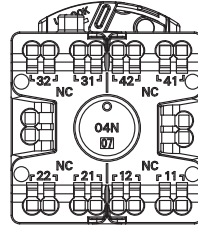

Four contacts (4NC)

Lighted

The switch terminal is same as that in the non-lighted models. Indicates the terminals for lighting (X1-X2). (Example: Four contacts (4NC) Lighted models)

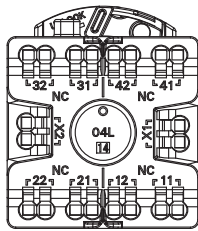

Terminal arrangement

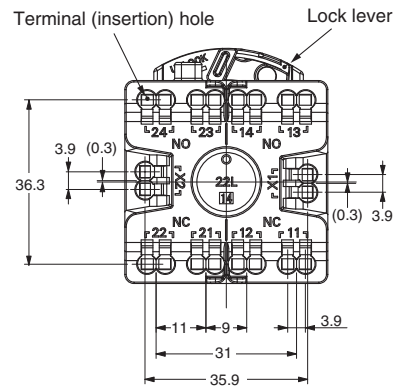

Terminal Arrangement

Type	Terminal Arrangement (BOTTOM VIEW)			
	1NC, 1NO (two contacts)	2NC, 2NO (four contacts)	3NC, 1NO (four contacts)	4NC (four contacts)
Non-lighted	NO 14 — 13 NC 12 — 11	NO NO 24 — 23 14 — 13 NC NC 22 — 21 12 — 11	NC NO 32 — 31 14 — 13 NC NC 22 — 21 12 — 11	NC NC 32 — 31 42 — 41 NC NC 22 — 21 12 — 11
Lighted	NO 14 — 13 X2 — ⊗ — X1 NC 12 — 11	NO NO 24 — 23 14 — 13 X2 — ⊗ — X1 NC NC 22 — 21 12 — 11	NC NO 32 — 31 14 — 13 X2 — ⊗ — X1 NC NC 22 — 21 12 — 11	NC NC 32 — 31 42 — 41 X2 — ⊗ — X1 NC NC 22 — 21 12 — 11

Note: The terminal arrangement shows the representative. It depends on the number of contacts in the series.

Structure and Nomenclature

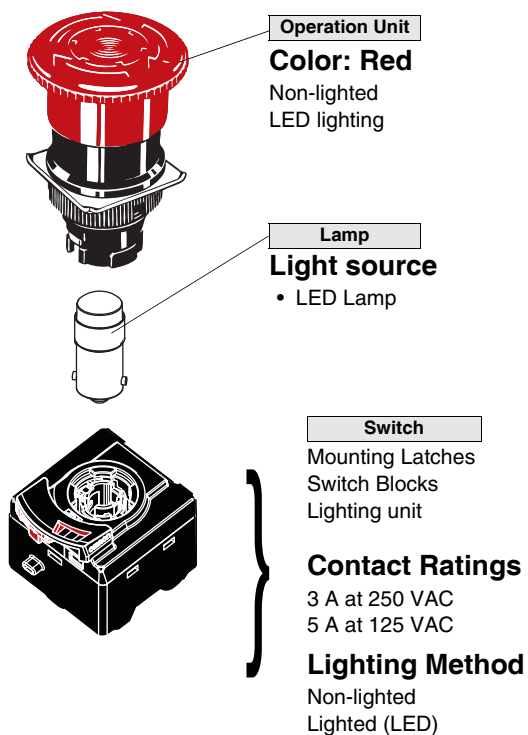

A22NE-PD

A22NE-P

A22E

Common Accessories and Tools

Common Note

A22NE-PD

Dimensions

(Unit: mm)

Non-lighted Models

A22NE-MP-PD□□-N

Pull-reset (40-dia.) Degree of Protection: IP65 oil-resistant models

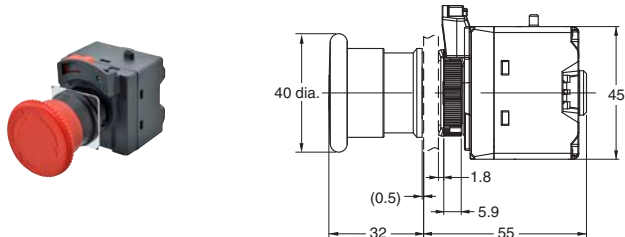

A22NE-MP-PD□□-N-69K

Pull-reset (40-dia.) Degree of Protection: IP69K

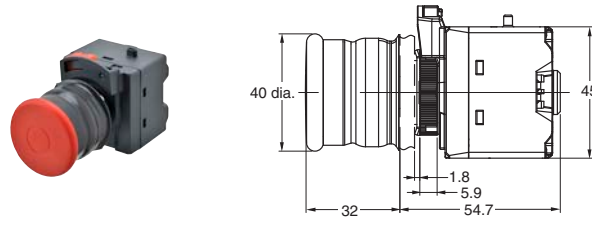

A22NE-S-PD□□-N

Small Turn-reset (30-dia.) Degree of Protection: IP65 oil-resistant models

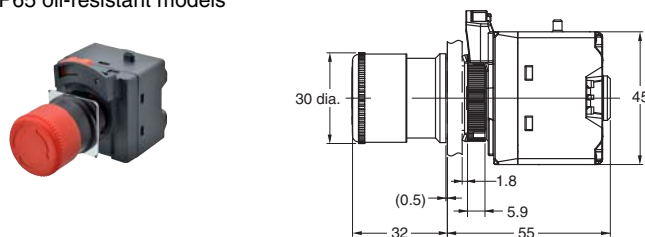

A22NE-M-PD□□-N

Medium Turn-reset (40-dia.) Degree of Protection: IP65 oil-resistant models

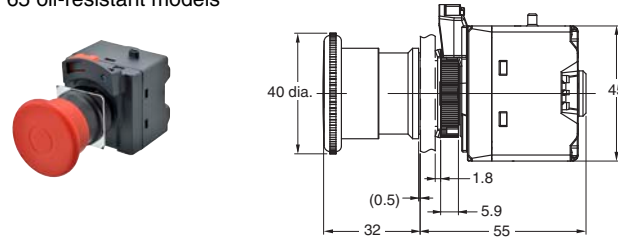

Note: The dimensions the same even if the Operation Unit is replaced with the A22NE-MR□□-N or the A22NE-MR□□-N-RD.

A22NE-L-PD□□-N

Large Turn-reset (60-dia.) Degree of Protection: IP65 oil-resistant models

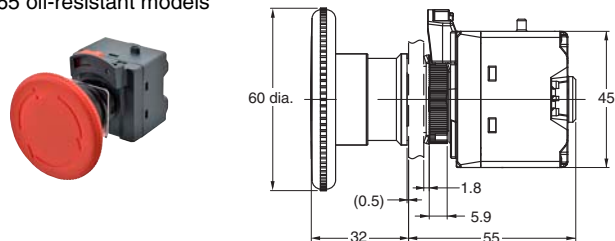

Lighted Model

A22NE-M-PD□□-C

Medium Turn-reset (40-dia.) Degree of Protection: IP65

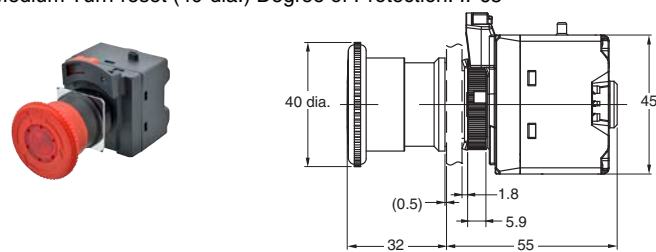

Note: Unless otherwise specified, a tolerance of $\pm 0.8\text{mm}$ applies to all dimensions.

Accessories (Order Separately)

LED Lamp A22NZ-L-RC

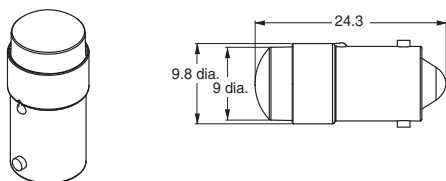

Note: For details on the accessories common to the screw terminal block types and push-in plus terminal block types, refer to "Common Accessories and Tools (Order Separately)" on page 51.

A22NE-PD

A22NE-P

A22E

Common Accessories and Tools

Common Note

Application

Mounting to the Panel

(1) Preparing the Panel

Panel hole dimension and panel thickness

- If outer surface treatment such as coating is performed for the panel, the panel dimensions after outer surface treatment must meet the specified panel dimensions.

Panel hole dimension	Panel thickness
22.3 dia.	1 to 5 mm

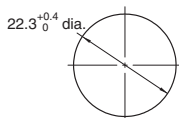

When using a A22Z-3360 (Order Separately) Lock Ring

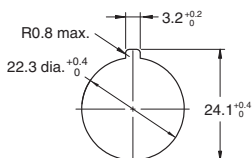

For 25-dia.

- Use the A22Z-R25 (Order Separately) rubber ring.
- * Switches with an IP69K degree of protection do not support the 25-dia.

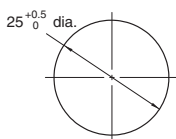

(2) Minimum mounting pitch (Dimension A, Dimension B)

Minimum mounting pitch

Type of operation unit	Dimension A (mm) min.	Dimension B (mm) min.
30-dia., 40-dia. models	50 *1	50
60-dia. model	70	70

- *1. If the Switch Unit lock levers all face the same direction at the minimum mounting pitch, be sure to note the order the Switch Units are attached to the Operation Unit.
- *2. When using each accessory (Order Separately), set the A and B dimensions in view of the dimensions of the accessories.
- *3. Make sure the mounting pitch does not hinder the operation.

Panel Hole Dimensions for 22.3 Diameter

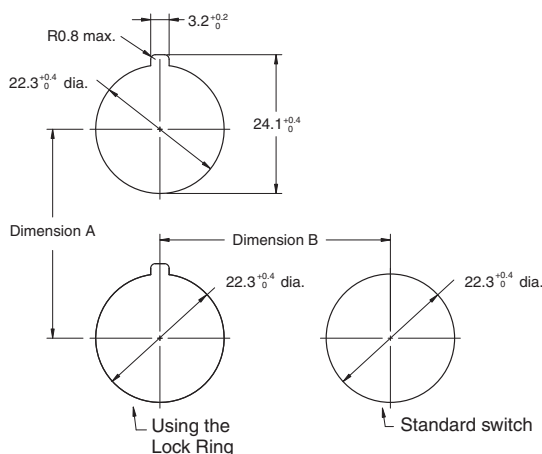

(3) Mounting the Operation Unit on the Panel

- Do not tighten the Tightening Nut more than necessary using tools such as pointed-nose pliers.
- Doing so will damage the Tightening Nut. (The tightening torque of the Tightening Nut is 1.0 to 2.0 N·m.) Tightening Wrench: A22Z-3905

Panel Hole of 22.3-mm Diameter

- Insert the Operation Unit from the front of the panel, insert the Lock Ring and Tightening Nut from the back of the panel, and tighten the Tightening Nut. Before tightening, check that the rubber washer is present between the Operation Unit and the panel.

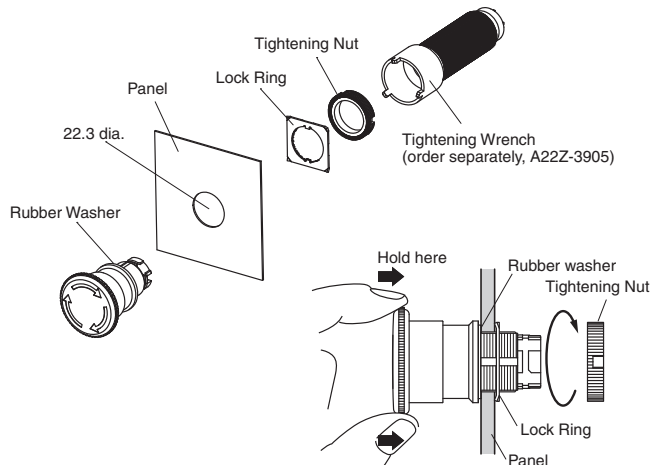

When the A22Z-3360 Lock Ring (Order Separately) is used

- Take note of the direction when mounting the Lock Ring.

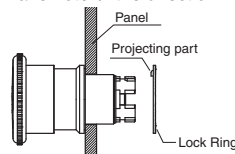

Panel Hole of 25-mm Diameter

- Insert the A22Z-R25 (Order Separately) between the Operation Unit and Panel, and tighten the Tightening Nut. Before tightening, check that the rubber washer supplied with the Operation Unit is present between the Operation Unit and the 25-dia. Ring.

Panel Hole of 30-mm Diameter

- Insert the A22Z-A30 (Order Separately) between the Operation Unit and Panel, and tighten the Tightening Nut. Before tightening, check that the supplied rubber washer is present between the Operation Unit and the panel, and between the 30-dia. Resin Attachment and the panel.
- * Switches with an IP69K degree of protection do not support the 30-dia.

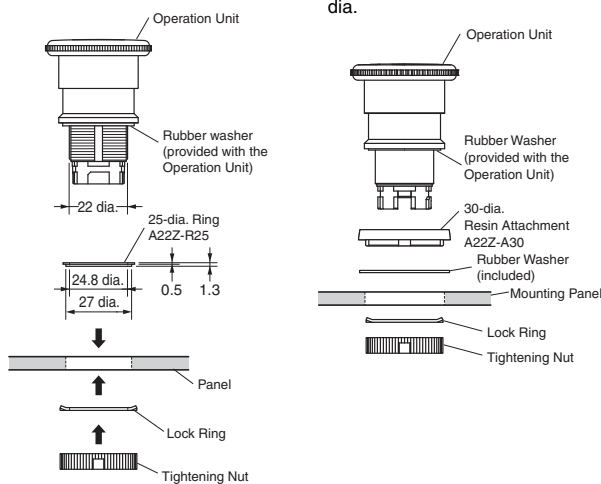

Panel Cutouts	Panel thickness
25 mm dia.	1 to 5 mm
30 mm dia.	1 to 3 mm

Removing the Switch Unit

When the Switch Unit is to be Removed

Slowly push the release port (concave part) of the lock lever with a screwdriver to release the lock. The lock lever moves to the release position.

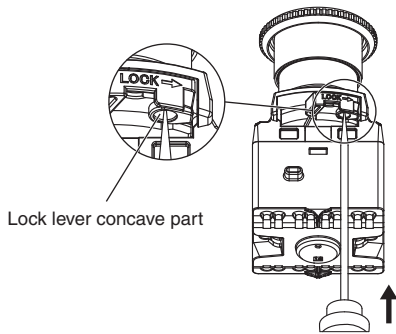

Lock lever concave part

<Lock lever position>

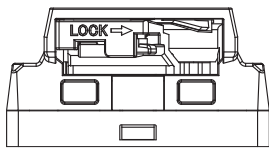

Release position

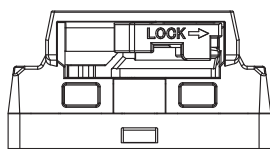

Locked position

When the lock lever is at the released position in this Switch, the NO and NC contact operation is reversed.

Set the lock lever to the locked position when using the Switch.

Installing the LED Lamp (Lighted Models)

When the LED Lamp is to be Installed

Insert the protrusions on the LED Lamp into the guides on the Switch Unit in direction (1), and then turn the LED Lamp in direction (2) to lock it in place.

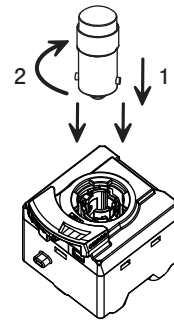

Safety Precautions

Be sure to read the precautions for **All PushButton Switches** in the website at: <http://www.ia.omron.com/>.

Indication and Meaning for Safe Use

 Warning	Indicates a potentially hazardous situation that, if not avoided, could result in serious injury or death. Additionally there may be significant property damage.
Precautions for Safe Use	Comments on what to do or avoid doing, to use the product safely.
Precautions for Correct Use	Supplementary comments on what to do or avoid doing to use the product safely and prevent its malfunctioning or an adverse effect on its performance or functions.

 **WARNING**

Do not perform wiring with power supplied to the Switch/Indicator. Do not touch the terminals or other charged parts while power is being supplied. Doing so may result in electric shock.



Precautions for Safe Use

- Make sure the Operation Unit and the Switch Unit are properly assembled.

<Assembling the Operation Unit and Switch Unit>

- (1) Assembling the Operation Unit and Switch Unit
Align the TOP indication (the mark ↓) on the Operation Unit with the TOP indication on the Switch Unit, and insert the Operation Unit while keeping the bottom A pressed.
- (2) Locking the lock lever

With a screwdriver inserted in the lock hole of the lock lever, bring the screwdriver in contact with the convex part of the case, and turn the lock lever until a clicking sound is heard.

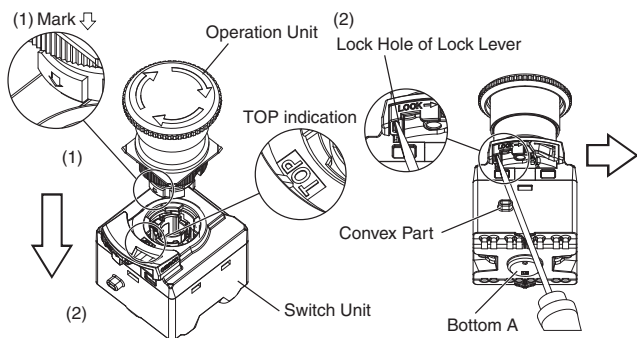

<Lock lever position>

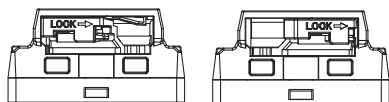

Release position
When the lock lever is at the released position in this Switch, the NO and NC contact operation is reversed.
Locked position
Set the lock lever to the locked position when using the Switch.

- When transition wiring is performed, make sure the switching current inside the Switch and the current based on the transition wiring is below the rated current of the Switch. If a current value higher than the rated current flows, it could result in emission of heat, or damage and deformation of the Switch, which could cause fire and locking of the contact, and thus a loss of safety.

- Do not disassemble or modify the Switch/Indicator under any circumstances.
- Doing so may prevent the Switch/Indicator from functioning to its full capability. Do not drop the Switch/Indicator. Do not apply pressure that may deform or alter the Switch/Indicator.
- The durability of the Switch varies considerably depending on the switching conditions. Always test the Switch/Indicator under actual working conditions before application and use the Switch/Indicator only for the number of switching operations allowed.
- Do not allow the load voltage and current to exceed the rated value. This may damage or burn out the Switch/Indicator.
- Do not use the Switch/Indicator in locations where explosive or flammable gases or liquid may be present or scattered. The electric arc or the heat caused by switching contacts may cause a fire or explosion.
- Do not use the Switch/Indicator in locations where toxic gases, such as H₂S, SO₂, NH₃, HNO₃, and Cl₂, may be present, or in locations subject to high temperature or humidity. Doing so may damage the Switch/Indicator due to contact failure or corrosion.
- Do not use the Switch/Indicator submersed in oil or water, or in locations continuously subject to splashes of oil or water. Doing so may result in oil or water entering and damaging the Switch/Indicator.
- Do not use or keep the Switch/Indicator under the following conditions:
 - Subject to severe temperature changes.
 - Subject to high humidity or condensation.
 - Subject to severe vibration or shock.
 - Where direct rays of the sun strike.
 - Where sea breeze may be present.
- Make sure that a rubber washer is present between the Operation Unit and the panel. In models with IP69K, make sure the rubber bush of the Operation Unit is properly attached. Otherwise, the specifications of the protective structure may not be satisfied.
- Do not apply excessive force to the Switch or wirings. Damage or deformation of the Switch Unit could result in an improper contact or a loss of safety.
- Use an appropriate wiring and crimp terminals (hereinafter, called ferrule terminals).
- Exercise caution to avoid wiring errors when connecting the terminals.
- To prevent wiring materials from smoking or ignition, confirm wire ratings and use the wiring materials given in the following table.

Wire Type	Wire material	Recommended Wire	Wire coating peeling amount
Solid wire/ Stranded Wire	Copper	0.25 to 1.5 mm ² AWG 24 to 16	Ferrules used: 10 to 12 mm (Varies depending on the recommended ferrule conductor length) Ferrules not used: 8 mm

Use wiring crimp terminals and ferrule terminals of the specified size.

- After storing the product for a long time exceeding 1 year, perform, at a minimum, inspections of the operating characteristics, contact resistance, insulation resistance, and dielectric strength as well as evaluate the product under the working conditions.
- This product is intended for indoor use only. Using the product outdoors will result in failure.
- Do not wire anything to the release holes.
- Do not tilt or twist a flat-blade screwdriver while it is inserted into a release hole on the terminal block. The terminal block may be damaged.
- Insert a flat-blade screwdriver into the release holes at an angle. The terminal block may be damaged if you insert the screwdriver straight in.
- Do not allow the flat-blade screwdriver to fall out while it is inserted into a release hole.
- Do not bend a wire past its natural bending radius or pull on it with excessive force. Doing so may cause the wire disconnection.
- Do not insert more than one wire into each terminal insertion hole.
- When mounting on a device with high airtightness, test operation in advance. There is a risk that the negative pressure will prevent the Operation Unit of from returning.
- Although the contacts of an A22NE-PD can be used with both the standard loads and microloads, once a contact has opened or closed under a load, you cannot again connect a small-capacity load. Doing so could roughen the contact surface, and result in loss of contact reliability.
- In the case of loads where an inrush current occurs when the contact is opened or closed, the durability may reduce due to extreme wear on the contacts. If necessary, insert a contact protection circuit.
- If a contact weld, the lock lever might not return to the release position, and contact inversion might not occur. In such a case, move the lock lever to the release position, and remove the Switch Unit from the Operation Unit.

Precautions for Correct Use

Wiring

1. Connecting Wires to the Push-In Plus Terminal Block

Part Names of the Terminal Block

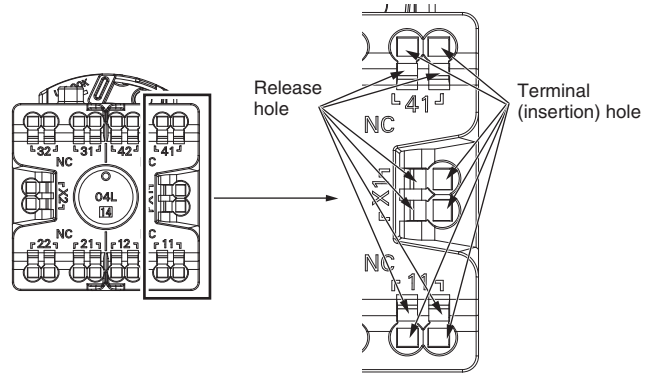

Connecting Wires with Ferrules and Solid Wires

- Insert the solid wire or ferrule straight into the terminal block until the end strikes the terminal block.
- If a wire is difficult to connect because it is too thin, use a flat-blade screwdriver in the same way as when connecting stranded wires.

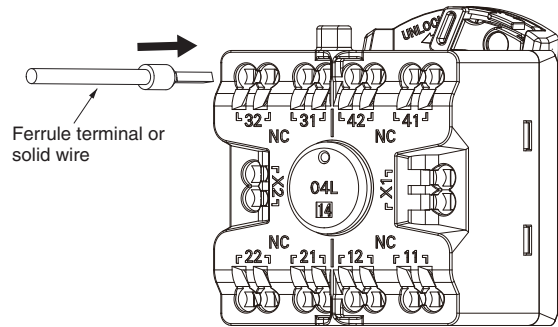

Connecting Stranded Wires

Use the following procedure to connect the wires to the terminal block.

1. Hold a flat-blade screwdriver at an angle and insert it into the release hole. The angle should be appropriately 10 to 15°. If the flat-blade screwdriver is inserted correctly, you will feel the spring in the release hole.
2. With the flat-blade screwdriver still inserted into the release hole, insert the wire into the terminal hole until the end strikes the terminal block.
3. Remove the flat-blade screwdriver from the release hole.

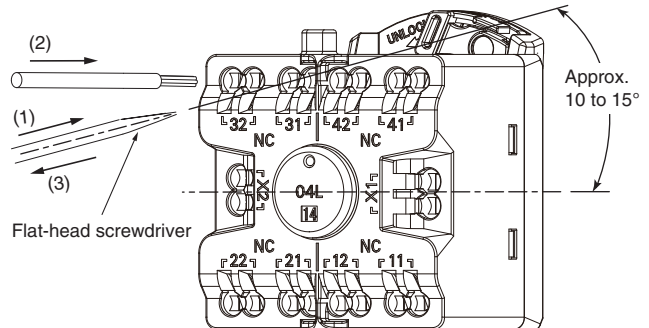

Checking Connections

- After the insertion, pull gently on the wire to make sure that it will not come off and it is securely fastened to the terminal block.
- If you use a ferrule with a conductor length of 10 mm, part of the conductor may be visible after the ferrule is inserted into the terminal block, but the product insulation distance will still be satisfied.

2. Removing Wires from the Push-In Plus Terminal Block

Use the following procedure to remove wires from the terminal block. The same method is used to remove stranded wires, solid wires, and ferrules.

1. Hold a flat-blade screwdriver at an angle and insert it into the release hole. The angle should be appropriately 10 to 15°.
2. With the flat-blade screwdriver still inserted into the release hole, remove the wire from the terminal insertion hole.
3. Remove the flat-blade screwdriver from the release hole.

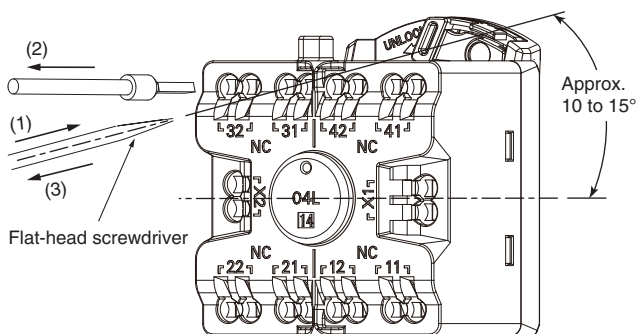

3. Recommended Ferrules and Crimp Tools
Coating peeling amount

Recommend Wire Type	Stripping length (Ferrules not used)
0.25 to 1.5 mm ² /AWG 24 to AWG 16	8 mm

Recommended ferrules

Applicable wire		Ferrule conductor length (mm)	Stripping length (mm) (Ferrules not used)	Recommended ferrules		
(mm ²)	(AWG)			Phoenix Contact product	Weidmuller product	Wago product
0.25	24	8	10	AI 0, 25-8	H0.25/12	216-301
		10	12	AI 0, 25-10	---	---
0.34	22	8	10	AI 0, 34-8	H0.34/12	216-302
		10	12	AI 0, 34-10	---	---
0.5	20	8	10	AI 0, 5-8	H0.5/14	216-201
		10	12	AI 0, 5-10	H0.5/16	216-241
0.75	18	8	10	AI 0, 75-8	H0.75/14	216-202
		10	12	AI 0, 75-10	H0.75/16	216-242
1/1.25	18/17	8	10	AI 1-8	H1.0/14	216-203
		10	12	AI 1-10	H1.0/16	216-243
1.25/1.5	17/16	8	10	AI 1, 5-8	H1.5/14	216-204
		10	12	AI 1, 5-10	H1.5/16	216-244
Recommended Crimp Tools				CRIMPFOX6 CRIMPFOX6T-F CRIMPFOX10S	PZ6 roto	Variocri mp4

- Note:**
1. Make sure that the outer diameter of the wire coating is smaller than the inner diameter of the insulation sleeve of the recommended ferrule.
 2. Make sure that the ferrule processing dimensions conform to the following figures.

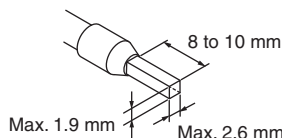

Recommended Flat-Blade Screwdrivers

Use a flat-blade screwdriver to connect and remove wires. Use one of the following flat-blade screwdrivers.

The following table shows manufacturers and models as of 2015/Dec.

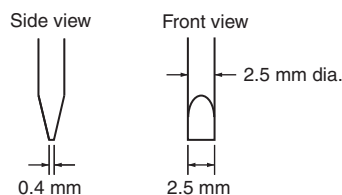

Model	Manufacture
ESD 0,40 x 2,5	Wera
SZS 0,4 x 2,5 SZF 0-0,4 x 2,5 *	Phoenix Contact
0.4 x 2.5 x 75 302	Wiha
AEF.2,5 x 75	Facom
210-719	Wago
SDI 0,4 x 2,5 x 75	Weidmuller

* The SZF 0-0,4 x 2,5 (manufactured by Phoenix Contact) can be procured through an OMRON exclusive purchase form (XW4Z-00B).

- After wiring the Switch/Indicator, provide a sufficient insulation distance.

LED Lamps

- A current-limiting resistor is built in the LED lamp, so the installation of an external resistance is not required.
- Lighting malfunction of the LED lamp
A micro-current of approximately 0.1 mA or less is sufficient to turn on the LED lamps. Take a countermeasure like adding a resistor to prevent mis-lighting in parallel to the LED lamp.
The micro-current varies with the machine (leak current or stray capacity between cables, etc.). Select resistance value and allowable power consumption that meet the actual current.

(Example of lighting malfunction prevention circuit)

When using a 24 VAC/DC Lighted Model

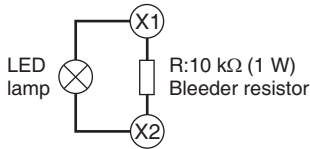

Be sure to read the "Safety Precautions" on page 56.

A22NE-P

A22NE-PD

A22NE-P

A22E

Common Accessories and Tools

Common Note

Install in 22-dia. or 25-dia. Panel Cutout

(When Using a Ring)

- The small size of the control panel is realized by conserving space and changing the direction of the wiring.
- Since there is no looseness in the wiring, there is a reduction in the maintenance efforts.
- A lock lever mechanism that can be easily operated is adopted.
- A maximum of up to six contact points can be combined together in the contact-point configuration.
- Oil-resistant to IP65 (non-lighted models) / IP65 (lighted models) / Supports IP69K high-temperature, high-pressure cleaning (pull-reset models).



For the most recent information on models that have been certified for safety standards, refer to your OMRON website.

Be sure to read the "Safety Precautions" on pages 33 and 56.

Model Number Structure

Model Number Legend (Completely Assembled) Shipped as a set which includes the Operation Unit, LED Lamp (lighted model only), Mounting Latches, Lighting Units (lighted model only), and Switch Block.

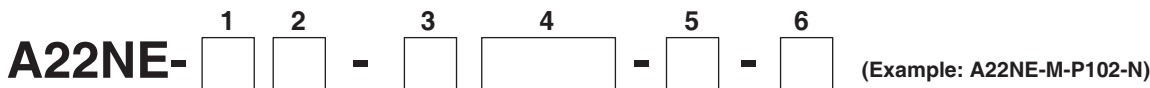

1. Operation Unit size (diameter)

Code	Description
S	30 dia.
M	40 dia.
L	60 dia.

2. Reset function

Code	Description
None	Turn-reset
P	Pull-reset *

* The pull-reset type is only available on the 40 dia. Operation Unit, non-lighted type. Not available on lighted types.

3. Contact specification/Terminal specification

Code	Description
P	Standard load/Push-in plus terminal block

4. Contacts

Code	Number of Switch Blocks		Unit position					
			Non-lighted			Lighted		
	NO	NC	1	2	3	1	2	3
002	0	1	---	---	NC	---	Lighting unit	NC
102	1	1	NO	---	NC	NO	Lighting unit	NC
202	0	2	NC	---	NC	NC	Lighting unit	NC
212	1	2	NC	NO	NC	---		
222	0	3	NC	NC	NC	---		

Note 1. NO: 1a-contact NC: 1b-contact
2. For details on the unit position, refer to the figure below.

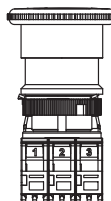

5. LED lamp voltage

Code	Description	LED Lamp Voltage
N	Non-lighted	---
A	Lighted (LED) *	6 VAC/DC
B		12 VAC/DC
C		24 VAC/DC
D		100/110/120 VAC
E		200/220/230/240 VAC

* Lighting color is red.

6. Others (Degree of Protection/Control box)

Code	Configuration
None	IP65
69K	IP69K
B *	Built-in control box





* One-contact unit type.

A22NE-P

Ordering Information





List of Models (Completely Assembled)

Non-lighted Models

Appearance	Operation	Degree of Protection	Contact configuration *	Set Model	Color of cap
	40-dia. head Medium Pull-reset A22NE-MP-P□□2-N	IP65 oil-resistant models	1NC (1)	A22NE-MP-P002-N	Red
			1NC, 1NO (2)	A22NE-MP-P102-N	
			2NC (2)	A22NE-MP-P202-N	
			2NC, 1NO (3)	A22NE-MP-P212-N	
			3NC (3)	A22NE-MP-P222-N	
	40-dia. head Medium Pull-reset A22NE-MP-P□□2-N-69K	IP69K	1NC (1)	A22NE-MP-P002-N-69K	
			1NC, 1NO (2)	A22NE-MP-P102-N-69K	
			2NC (2)	A22NE-MP-P202-N-69K	
			2NC, 1NO (3)	A22NE-MP-P212-N-69K	
			3NC (3)	A22NE-MP-P222-N-69K	
	30-dia. head Small Turn-reset A22NE-S-P□□2-N	IP65 oil-resistant models	1NC (1)	A22NE-S-P002-N	
			1NC, 1NO (2)	A22NE-S-P102-N	
			2NC (2)	A22NE-S-P202-N	
			2NC, 1NO (3)	A22NE-S-P212-N	
			3NC (3)	A22NE-S-P222-N	
	40-dia. head Medium Turn-reset A22NE-M-P□□2-N	IP65 oil-resistant models	1NC (1)	A22NE-M-P002-N	
			1NC, 1NO (2)	A22NE-M-P102-N	
			2NC (2)	A22NE-M-P202-N	
			2NC, 1NO (3)	A22NE-M-P212-N	
			3NC (3)	A22NE-M-P222-N	
	60-dia. head Large Turn-reset A22NE-L-P□□2-N	IP65 oil-resistant models	1NC (1)	A22NE-L-P002-N	
			1NC, 1NO (2)	A22NE-L-P102-N	
			2NC (2)	A22NE-L-P202-N	
			2NC, 1NO (3)	A22NE-L-P212-N	
			3NC (3)	A22NE-L-P222-N	

* The number in parentheses () indicates the number of switch units.

Lighted Model

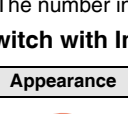
Appearance	Operation	Degree of Protection	Contact configuration *	LED lamp voltage	Set Model	Color of cap	
	40-dia. head Medium Turn-reset A22NE-M-P□□2-A	IP65	1NC (1)	6 VAC/VDC	A22NE-M-P002-A	Red	
			1NC, 1NO (2)		A22NE-M-P102-A		
			2NC (2)		A22NE-M-P202-A		
	40-dia. head Medium Turn-reset A22NE-M-P□□2-B		1NC (1)	1NC, 1NO (2)	12 VAC/VDC		A22NE-M-P002-B
				2NC (2)			A22NE-M-P102-B
				2NC (2)			A22NE-M-P202-B
	40-dia. head Medium Turn-reset A22NE-M-P□□2-C		1NC (1)	1NC, 1NO (2)	24 VAC/VDC		A22NE-M-P002-C
				2NC (2)			A22NE-M-P102-C
				2NC (2)			A22NE-M-P202-C
	40-dia. head Medium Turn-reset A22NE-M-P□□2-D		1NC (1)	1NC, 1NO (2)	100, 110, 120 VAC		A22NE-M-P002-D
				2NC (2)			A22NE-M-P102-D
				2NC (2)			A22NE-M-P202-D
	40-dia. head Medium Turn-reset A22NE-M-P□□2-E		1NC (1)	1NC, 1NO (2)	220, 230, 240 VAC		A22NE-M-P002-E
				2NC (2)			A22NE-M-P102-E
				2NC (2)			A22NE-M-P202-E

* The number in parentheses () indicates the number of switch units.

Switch with Integrated Control Box

Appearance	Contact configuration (Number of switch blocks)	Model
	1NC (1)	A22NE-M-P002-N-B
	1NC, 1NO (2)	A22NE-M-P102-N-B
	2NC (2)	A22NE-M-P202-N-B

A22NE-PD

A22NE-P

A22E

Common Accessories and Tools

Common Note

Subassembled The Operation Unit, LED Lamp, Mounting Latches, Switch Blocks, and Lighting Unit can be ordered separately. Use them in combination for models that are not available as assembled Units. These can also be used as inventory for maintenance parts.

Non-lighted

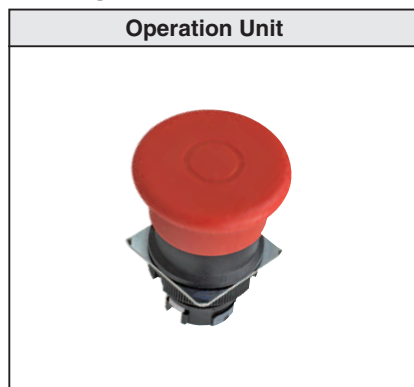

Lighted

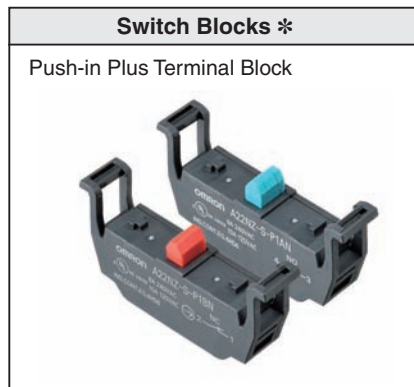
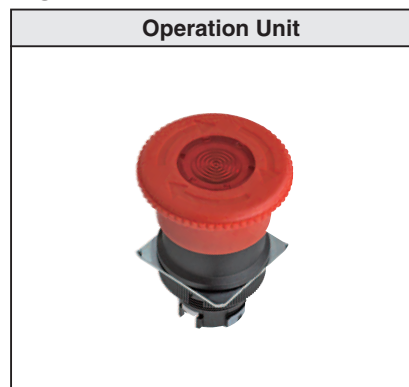

* Up to three Switch Blocks can be mounted for multiple contacts.

A22NE-P

A22NE-PD







A22NE-P

A22E

Common Accessories and Tools

Common Note

Operation Unit Non-lighted

		Size	Small (30 dia.)	Medium (40 dia.)	Large (60-dia.)
Function	Sealing capability	Single item order model			
Pull-reset	IP65 oil-resistant models	---	A22NE-MP-N 		---
	IP69K	---	A22NE-MP-N-69K 		---
Turn-reset	IP65 oil-resistant models	A22NE-S-N 	A22NE-M-N 	A22NE-L-N 	
			A22NE-MRO-N A22NE-MRO-N-RD 		
			A22NE-MRS-N A22NE-MRS-N-RD 		





Lighted

		Size	Medium (40 dia.)
Function	Sealing capability	Single item order model	
Turn-reset	IP65	A22NE-M-L 	

LED lamp

Appearance	LED light	Rated voltage	Model	Remarks
	Red	6 VAC/VDC	A22NZ-L-RA	These LED lamps are for exclusive use with the A22N and the A22NE-P. These are provided with the completely assembled set of lighted models. Order LED lamps only when replacing them.
		12 VAC/VDC	A22NZ-L-RB	
		24 VAC/VDC	A22NZ-L-RC	
		100, 110, 120 VAC	A22NZ-L-RD	
		200, 220, 230, 240 VAC	A22NZ-L-RE	

Accessories (Order Separately)

Item	Appearance	Contact specifications		Model	Remarks
Switch Blocks (one contact)		1NO (Blue)	Standard load	A22NZ-S-P1AN	Provided as standard. Order Switch Blocks only when adding or replacing them.
		1NC (Red)	Standard load	A22NZ-S-P1BN	
Switch Blocks (two contacts)		2NC (Red)	Standard load	A22NZ-S-P2BN	Order Switch Blocks only when adding or replacing them.
		1NO/1NC (White)	Standard load	A22NZ-S-P2CN	
Lighting unit		6 VAC/VDC		A22NZ-T-APN	These are provided with the completely assembled set of lighted models. Order Lighting Units only when replacing them.
		12 VAC/VDC		A22NZ-T-BPN	
		24 VAC/VDC		A22NZ-T-CPN	
		100, 110, 120 VAC		A22NZ-T-DPN	
		200, 220, 230, 240 VAC		A22NZ-T-EPN	
Mounting Latches		---		A22NZ-H-02	This Mounting Latch is for exclusive use with the A22NE-P. It is provided with the completely assembled set. Order Mounting Latches only when mounting Switch Blocks or Lighting Units that are purchased individually.
Control Boxes (Enclosures)		One hole, yellow box		A22NZ-A-B01Y	Material: Polycarbonate resin. Can be combined with 1-contact Switch Blocks. (Cannot be combined with 2-contact Switch Blocks.) *

Note: For details on the accessories common to the screw terminal block types and push-in plus terminal block types, refer to "Common Accessories and Tools (Order Separately)" on page 51.

* The A22NZ-A-B01Y Control Box cannot be used in combination with the A22Z-3476-1 90-dia. Legend Plates for Emergency Stop or the A22Z-EG□ E-stop Shrouds.

A22NE-P

Specifications

Certified Standard Ratings

- UL508 (File No. E76675), CSA C22.2 No.14
6 A at 240 VAC, 10 A at 120 VAC
- TÜV (EN60947-5-1) - Certified direct opening -
(EN60947-5-5)
AC-15 3 A at 240 VAC
DC-13 4 A at 24 VDC
- CCC (GB14048.5)
AC-15 3 A at 240 VAC
DC-13 4 A at 24 VDC

Applicable Standards

UL1059, UL486E (Push-in Plus Terminal Block Types)

Note: Use a 10 A fuse type gI or gG that conforms to IEC60269 as a short-circuit protection device. This fuse is not provided in the main unit.

Ratings

Contacts (Standard Load)

Rated insulation voltage (V)	Rated carry current (A)	Rated voltage (V)	Rated current (A)			
			AC15 (Inductive load)	AC12 (Resistive load)	DC13 (Inductive load)	DC12 (Resistive load)
600	10	24 VAC	10	10	---	---
		120 VAC	6	10		
		240 VAC	3	6		
		380 VAC	1.9	2		
		440 VAC	1.6	2	4	8
		24 VDC	---	---		
		120 VDC				
		240 VDC				
			1.1	2.2	0.55	1.1

- Note: 1.** The above ratings were obtained by conducting tests under the following conditions.
 (1) Ambient temperature: 20°±2°C
 (2) Ambient humidity: 65±5%
 (3) Operating frequency: 20 operations/minute
- 2.** Minimum applicable load: 10 mA at 5 VDC (Resistive load)
 The operating range may vary depending on the usage conditions and type of load.

Certified Standards

Certification body	Standards	File No.
UL *	UL508, C22.2 No.14	E76675
TÜV SÜD	EN60947-5-1 (Certified direct opening), EN60947-5-5	Consult your OMRON representative for details.
CQC (CCC)	GB14048.5	2017010305959182

Note: Only models with NC contacts have a direct opening mechanism.

* UL-certification for CSA C22.2 No. 14 has been obtained.

LED Lamp

Rated voltage	Operating voltage	Current value
6 VAC/VDC	6 VAC/VDC ± 10%	Approx. 11 mA
12 VAC/VDC	12 VAC/VDC ± 10%	Approx. 12 mA
24 VAC/VDC	24 VAC/VDC ± 10%	Approx. 12 mA
100 VAC	100 VAC ± 10%	Approx. 12 mA
110 VAC	110 VAC ± 10%	
120 VAC	100 VAC to 130 VAC	
200 VAC	200 VAC ± 10%	Approx. 12 mA
220 VAC	220 VAC ± 10%	
230 VAC	230 VAC ± 10%	
240 VAC	220 VAC to 250 VAC	

A22NE-PD

A22NE-P

A22E

Common Accessories and Tools

Common Note

Characteristics

Item		Operation	Turn-reset		Pull-reset	
			Non-lighted model	Lighted Model	Non-lighted model	
			A22NE-□-P□□□-N	A22NE-M-P□□□-□	A22NE-MP-P□□□-N	A22NE-MP-P□□□-N-69K
Allowable operating frequency	Mechanical	30 operations/minute or less (One operation consists of set and reset operations.)				
	Electrical	30 operations/minute or less (One operation consists of set and reset operations.)				
Insulation resistance *1		100 MΩ min. (at 500 VDC)				
Contact resistance		100 mΩ max. (initial value)				
Dielectric strength	Between terminals of same polarity*1	2,500 VAC, 50/60 Hz 1 minute (initial value)				
	Between each terminal and ground	2,500 VAC, 50/60 Hz 1 minute (initial value)				
Vibration resistance	Malfunction	10 to 55 Hz, 1.5 mm double amplitude (contact separation within 1 ms)				
Shock resistance	Malfunction	250 m/s ² max. (contact separation within 1 ms)				
Durability	Mechanical	300,000 operations min. (One operation consists of set and reset operations.)			100,000 operations min. (One operation consists of set and reset operations.)	
	Electrical	300,000 operations min. (One operation consists of set and reset operations.)			100,000 operations min. (One operation consists of set and reset operations.)	
Ambient operating temperature *2		-20 to +70°C	-20 to +55°C	-20 to +70°C	-20 to +70°C *3	
Ambient operating humidity		35 to 85% RH				
Ambient storage temperature *2		-40 to +70°C				
Degree of protection *4		IP65 oil-resistant models *5	IP65	IP65 oil-resistant models *5	IP69K	
Electric shock protection class		Class II				
PTI (tracking characteristic)		175				
Degree of contamination		3 (EN 60947-5-1)				
Minimum direct opening stroke		11 mm				
Minimum direct opening force		45 N				
Conditional short-circuit current		100 A (EN 60947-5-1)				
Wight (for a 40-dia. head 1NC/1NO Operation Unit)		Approx. 55g	Approx. 60g	Approx. 85 g	Approx. 115 g	

- *1. State when an LED is not added between terminals of the same polarity on a lighting unit. Does not apply to lighted-type 100 to 200 V lighting units.
- *2. With no icing or condensation.
- *3. Capable of operation at up to 80°C under IP□9K testing conditions per JIS D 5020.
- *4. The degree of protection from the front of the panel.
- *5. The degree of protection is IP65 even with an integrated control box, but the system is not oil resistant.

Operating Characteristics

Item	Turn-reset	Pull-reset	
	Lighted / non-lighted models	Non-lighted model	Non-lighted model (Models with IP69K)
Total travel force (TTF)	45 N max.	60 N max.	70 N max.
Return force (RF)	0.25N·m * max.	60 N max.	70 N max.
Total travel (TT)	10 ±1 mm	5.5 ±1 mm	5.5 ±1 mm

* Rotation torque value.

Terminal Arrangement (BOTTOM VIEW)

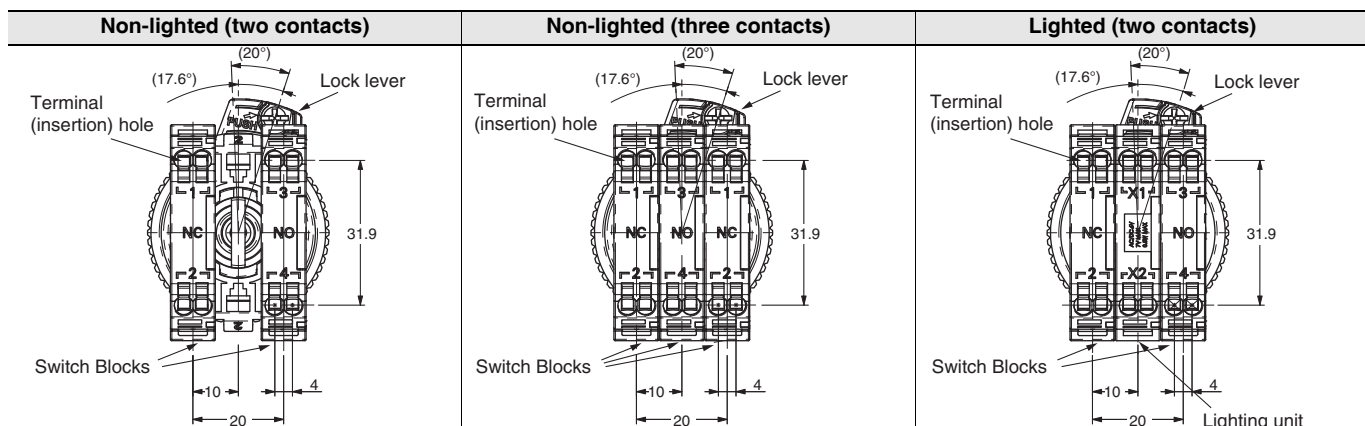

A22NE-P

A22NE-PD

Terminal connection

Type	Terminal Connection (BOTTOM VIEW)									
	1NC, 1NO (two contacts)		2NC (two contacts)		2NC, 1NO (three contacts)			3NC (three contacts)		
Non-lighted	NC 1 2	NO 3 4	NC 1 2	NC 1 2	NC 1 2	NC 1 2	NO 3 4	NC 1 2	NC 1 2	NC 1 2
Lighted	1 2	X1 X X2	3 4	1 2	X1 X X2	1 2				

Note: The above terminal connection diagrams are examples for 1NO, 1NC (two contacts), or 2NC (two contacts).

A22NE-P

Terminal wiring drawings of two-contact Switch Units

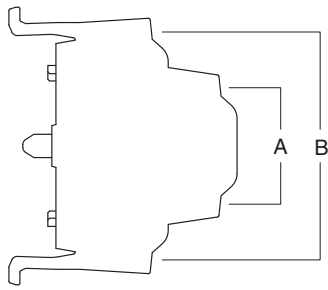

Type	Terminal Connection (BOTTOM VIEW)	
	2NC (two contacts)	1NC, 1NO (two contacts)
A	21 22	21 22
B	11 12	13 14

A22E

Structure and Nomenclature

Common Accessories and Tools

Common Note

Operation Unit
Color: Red
 Non-lighted
 LED lighting

Lamp
Light source
 • LED Lamp

Switch
 Mounting Latches
 Switch Blocks
 Lighting unit

Contact Ratings
 6 A at 240 VAC
 10 A at 120 VAC

Lighting Method
 Non-lighted
 Lighted (LED)

Dimensions

Non-lighted Models

A22NE-MP-P□□2-N

Pull-reset (40-dia.) Degree of Protection: IP65 oil-resistant models

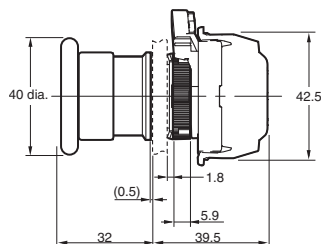
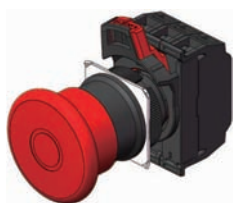

A22NE-MP-P□□2-N-69K

Pull-reset (40-dia.) Degree of Protection: IP69K

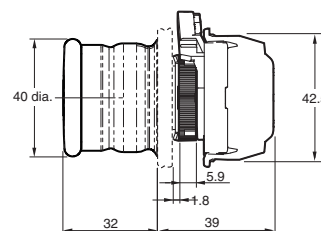
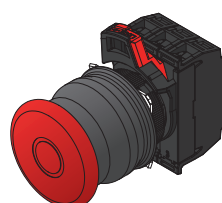

A22NE-S-P□□2-N

Small Turn-reset (30-dia.) Degree of Protection: IP65 oil-resistant models

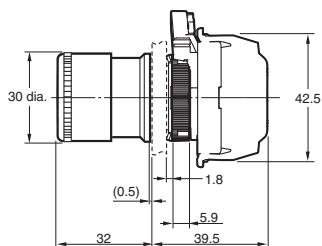
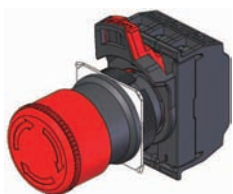

A22NE-M-P□□2-N

Medium Turn-reset (40-dia.) Degree of Protection: IP65 oil-resistant models

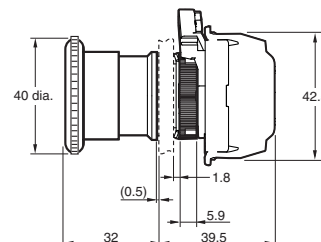
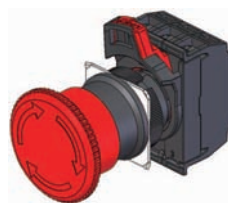

Note: The dimensions are the same even if the Operation Unit is replaced with the A22NE-MR□-N or the A22NE-MR□-N-RD.

A22NE-L-P□□2-N

Large Turn-reset (60-dia.) Degree of Protection: IP65 oil-resistant models

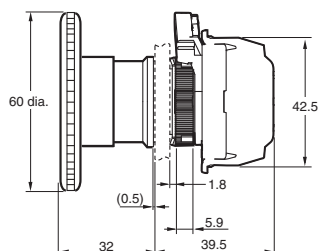
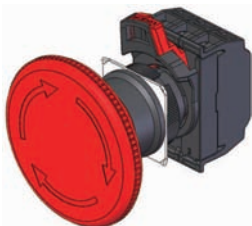

Lighted Model

A22NE-M-P□□2-□

Medium Turn-reset (40-dia.) Degree of Protection: IP65

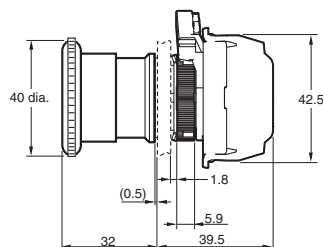
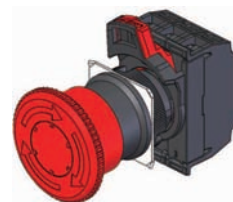

Dimensions when a two-contact Switch Block is attached

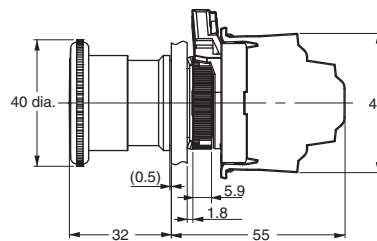

Note: Unless otherwise specified, a tolerance of ± 0.8 mm applies to all dimensions.

A22NE-PD

A22NE-P

A22E

Common Accessories and Tools

Common Note

A22NE-P

Accessories (Order Separately)

Switch Block with Push-In Plus technology

Switch Block (one contact)

A22NZ-S-P1□N

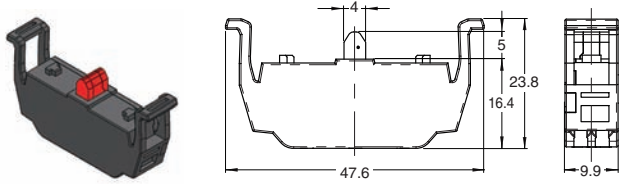

Switch Block (two contacts)

A22NZ-S-P2□N

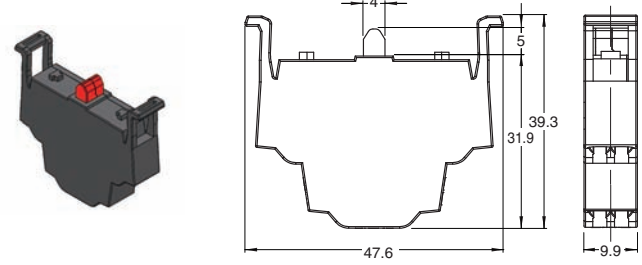

Lighting unit

A22NZ-T□PN

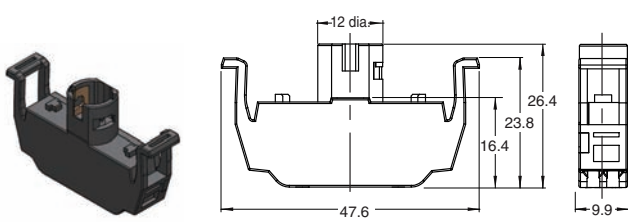

Mounting Latches

A22NZ-H-02

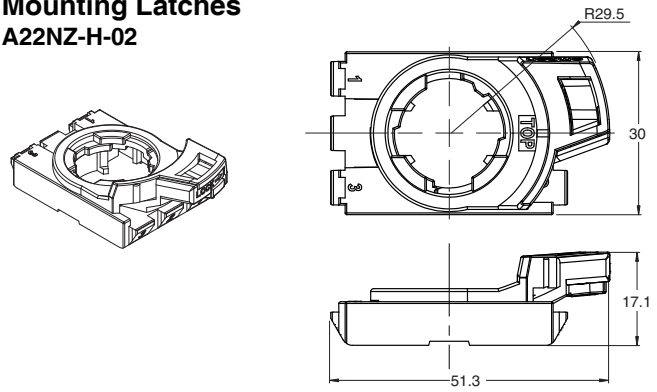

LED Lamp

A22NZ-L□□

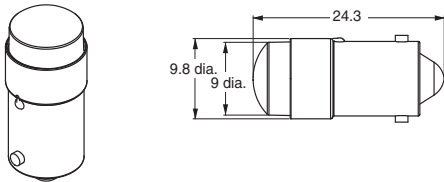

Control Box

A22NZ-A-B01Y

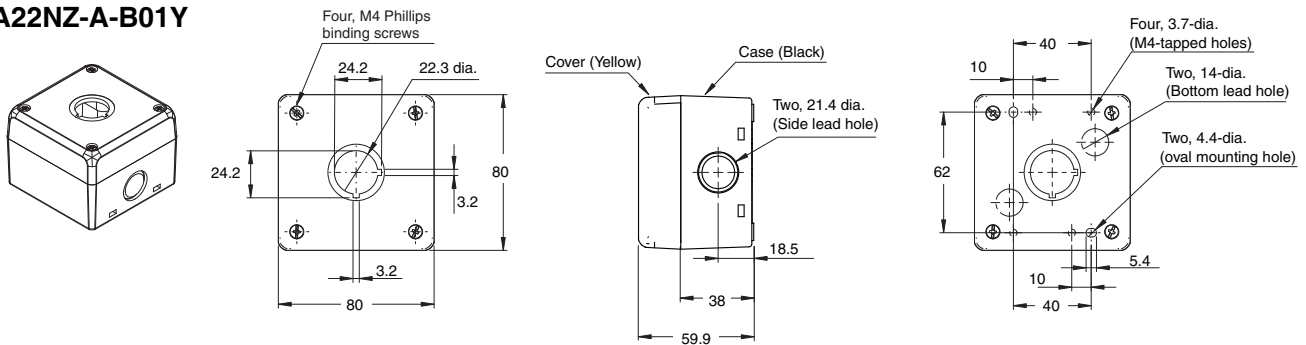

Note: For details on the accessories common to the screw terminal block types and push-in plus terminal block types, refer to "Common Accessories and Tools (Order Separately)" on page 51.

A22NE-PD

A22NE-P

A22E

Common Accessories and Tools

Common Note

Application

Mounting to the Panel

(1) Preparing the Panel

Panel hole dimension and panel thickness

- If outer surface treatment such as coating is performed for the panel, the panel dimensions after outer surface treatment must meet the specified panel dimensions.

Panel hole dimension	Panel thickness
22.3 dia.	1 to 5 mm

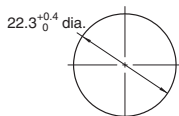

When using a A22Z-3360 (Order Separately) Lock Ring

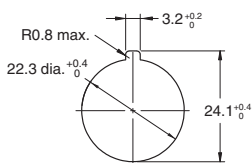

For 25-dia.

- Use the A22Z-R25 (Order Separately) rubber ring.
- * Switches with an IP69K degree of protection do not support the 25-dia.

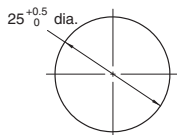

(2) Minimum mounting pitch (Dimension A, Dimension B)

Minimum mounting pitch

Type of operation unit	Dimension A (mm) min.	Dimension B (mm) min.
30-dia., 40-dia. models	50 *1	50
60-dia. model	70	70

- *1. If the Mounting Collar lock levers all face the same direction at the minimum mounting pitch, be sure to note the order the mounting collars are attached to the Operation Unit.
- *2. When using each accessory (Order Separately), set the A and B dimensions in view of the dimensions of the accessories.
- *3. Make sure the mounting pitch does not hinder the operation.

Panel Hole Dimensions for 22.3 Diameter

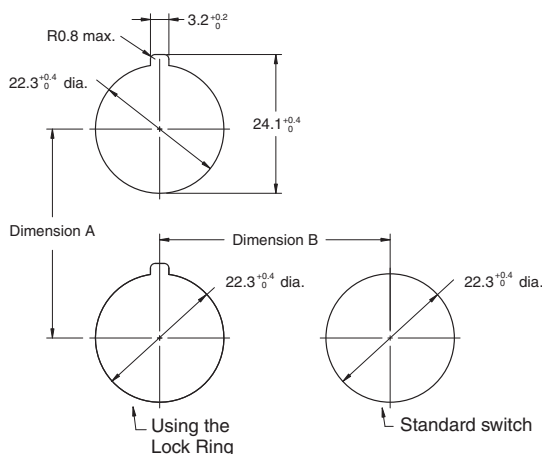

(3) Mounting the Operation Unit on the Panel

- Do not tighten the Tightening Nut more than necessary using tools such as pointed-nose pliers.
- Doing so will damage the Tightening Nut. (The tightening torque of the Tightening Nut is 1.0 to 2.0 N·m.) Tightening Wrench: A22Z-3905

Panel Hole of 22.3-mm Diameter

- Insert the Operation Unit from the front of the panel, insert the Lock Ring and Tightening Nut from the back of the panel, and tighten the Tightening Nut. Before tightening, check that the rubber washer is present between the Operation Unit and the panel.

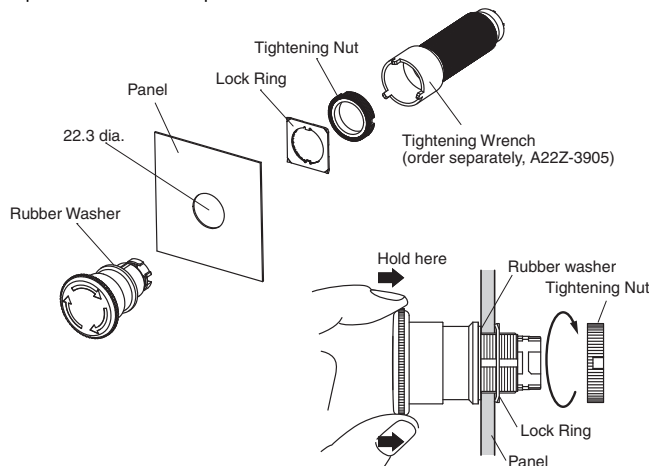

When the A22Z-3360 Lock Ring (Order Separately) is used

- Take note of the direction when mounting the Lock Ring.

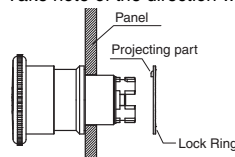

Panel Hole of 25-mm Diameter

- Insert the A22Z-R25 (Order Separately) between the Operation Unit and Panel, and tighten the Tightening Nut. Before tightening, check that the rubber washer supplied with the Operation Unit is present between the Operation Unit and the 25-dia. Ring.

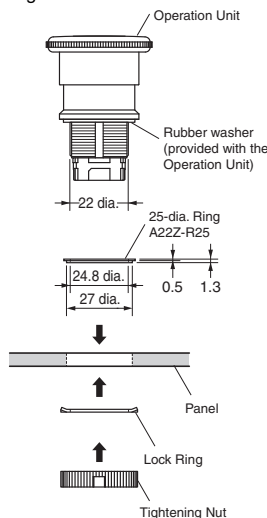

Panel Hole of 30-mm Diameter

- Insert the A22Z-A30 (Order Separately) between the Operation Unit and Panel, and tighten the Tightening Nut. Before tightening, check that the supplied rubber washer is present between the Operation Unit and the panel, and between the 30-dia. Resin Attachment and the panel.
- * Switches with an IP69K degree of protection do not support the 30-dia.

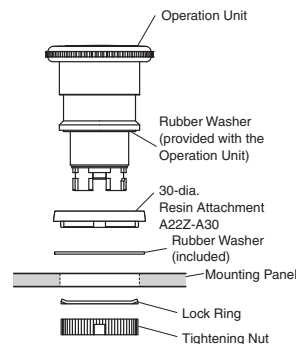

Panel Cutouts	Panel thickness
25 mm dia.	1 to 5 mm
30 mm dia.	1 to 3 mm

A22NE-PD

A22NE-P

A22E

Common Accessories and Tools

Common Note

Removing the Mounting Latch

When the Mounting Latch is to be Removed

- Press the lock lever in from the back side to release the lock, and then hook the Mounting Collar with a screwdriver, move it in the direction indicated at (2), and remove it. Turn the lever all of the way until it clicks into place.

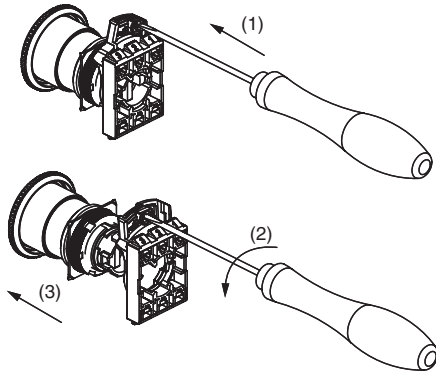

Switch Blocks and Lighting Unit

(1) Installing the Switch Blocks and Lighting Unit

- Catch the projection on the opposite side of the Mounting Collar from the lever side and press the Switch Block in the direction indicated at (1).

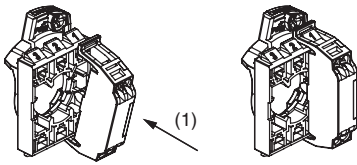

(2) Removing the Switch Blocks and Lighting Units

- Insert a screwdriver into the gap between the Mounting Collar and Switch Block and press it inward in the direction shown at (2).

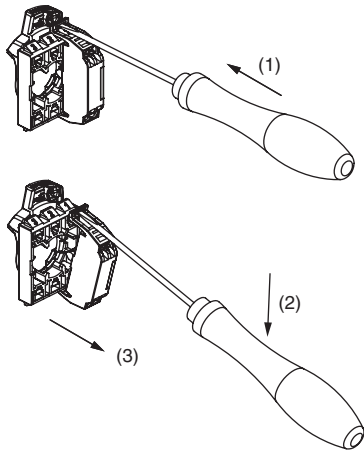

Attaching the LED Lamp to the Lighting Unit

When the LED Lamp is to be Installed

- Insert the protrusions on the LED Lamp into the guides on the Lighting Unit and then turn the LED Lamp in direction (2) to lock it in place.

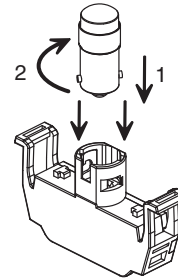

Control Box

(1) Mounting the Switch

Mount the Switch in the same way as for a standard panel.
The tightening torque of the Box screws is 1.4 to 2.0 N·m.

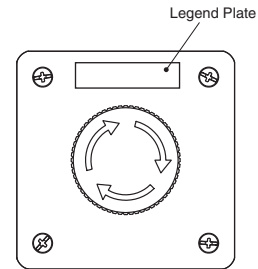

(2) Creating a Cable Hole

To open a cable hole, leave the cover attached, place the tip of a screwdriver in the grooves at four locations around the cable hole, and strike the screwdriver with a hammer to open the hole.

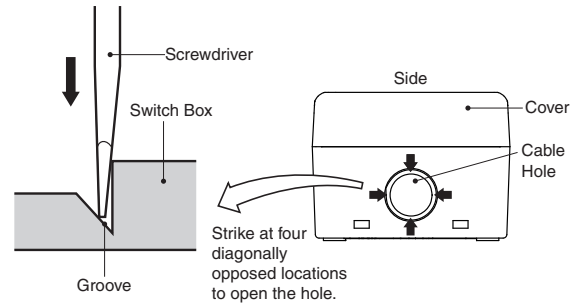

(3) Securing the Connector Cable

1. Insert the connector into the cable port hole in the Box and secure with the fixing ring inside the box.
2. Pass the tightening cap through the cable, insert the cable into the connector, and tighten the tightening cap to secure the cable.

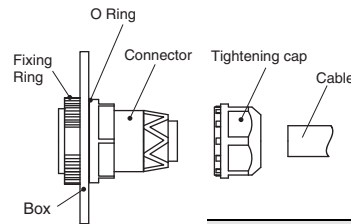

Cable diameter (mm)	Connector
7 to 9 dia.	A22Z-3500-1
9 to 11 dia.	A22Z-3500-2

Safety Precautions

Be sure to read the precautions for **All PushButton Switches** in the website at: <http://www.ia.omron.com/>.

Indication and Meaning for Safe Use

 Warning	Indicates a potentially hazardous situation that, if not avoided, could result in serious injury or death. Additionally there may be significant property damage.
Precautions for Safe Use	Comments on what to do or avoid doing, to use the product safely.
Precautions for Correct Use	Supplementary comments on what to do or avoid doing to use the product safely and prevent its malfunctioning or an adverse effect on its performance or functions.

 **WARNING**

Do not perform wiring with power supplied to the Switch/Indicator. Do not touch the terminals or other charged parts while power is being supplied. Doing so may result in electric shock.



Precautions for Safe Use

- If the Operation Unit is separated from the Switch Units, the equipment will not stop, resulting in a hazardous situation. Make sure the Operation Unit, Mounting Latches, and the Switch Units are properly assembled.

<Assembling the Operation Unit and the Mounting Latches>
Align the TOP indication (the  mark) on the Operation Unit with the TOP indication on the Mounting Latches to fit it properly, and turn the lock lever on the Mounting Latch in the direction shown in the figure below until a clicking sound is heard.

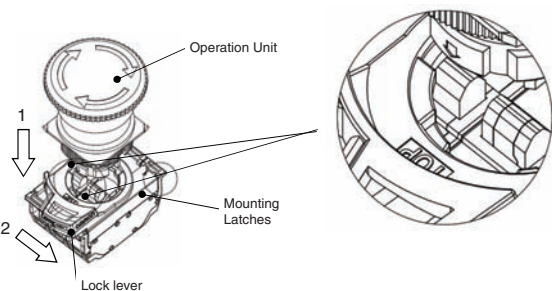

<Assembling the Mounting Latches and Switch Blocks>
Make sure the hooking part (convex part) on the Mounting Latches is perfectly latched into the hooking part (concave part) on the Switch Block.

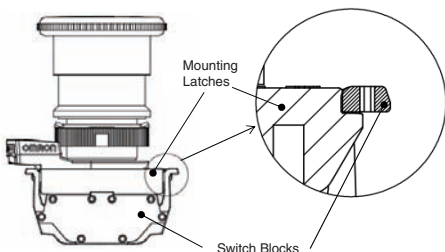

- When transition wiring is performed, make sure the switching current inside the Switch and the current based on the transition wiring is below the rated current of the Switch. If a current value higher than the rated current flows, it could result in emission of heat, or damage and deformation of the Switch, which could cause fire and locking of the contact, and thus a loss of safety.
- Do not disassemble or modify the Switch/Indicator under any circumstances.

- Doing so may prevent the Switch/Indicator from functioning to its full capability. Do not drop the Switch/Indicator. Do not apply pressure that may deform or alter the Switch/Indicator.
- The durability of the Switch varies considerably depending on the switching conditions. Always test the Switch/Indicator under actual working conditions before application and use the Switch/Indicator only for the number of switching operations allowed.
- Do not allow the load voltage and current to exceed the rated value. This may damage or burn out the Switch/Indicator.
- Do not use the Switch/Indicator in locations where explosive or flammable gases or liquid may be present or scattered. The electric arc or the heat caused by switching contacts may cause a fire or explosion.
- Do not use the Switch/Indicator in locations where toxic gases, such as H₂S, SO₂, NH₃, HNO₃, and Cl₂, may be present, or in locations subject to high temperature or humidity. Doing so may damage the Switch/Indicator due to contact failure or corrosion.
- Do not use the Switch/Indicator submerged in oil or water, or in locations continuously subject to splashes of oil or water. Doing so may result in oil or water entering and damaging the Switch/Indicator.
- Do not use or keep the Switch/Indicator under the following conditions:
 - Subject to severe temperature changes.
 - Subject to high humidity or condensation.
 - Subject to severe vibration or shock.
 - Where direct rays of the sun strike.
 - Where sea breeze may be present.
- Make sure that a rubber washer is present between the Operation Unit and the panel. In models with IP69K, make sure the rubber bush of the Operation Unit is properly attached. Otherwise, the specifications of the protective structure may not be satisfied.
- Do not apply excessive force to the Switch or wirings. Damage or deformation of the Switch Block could cause an improper contact or a loss of safety.
- Use an appropriate wiring and crimp terminals (hereinafter, called ferrule terminals).
- Exercise caution to avoid wiring errors when connecting the terminals.
- To prevent wiring materials from smoking or ignition, confirm wire ratings and use the wiring materials given in the following table.

Wire Type	Wire material	Recommended Wire	Wire coating peeling amount
Solid wire/ Stranded Wire	Copper	0.25 to 1.5 mm ² AWG 24 to 16	Ferrules used: 10 to 12 mm (Varies depending on the recommended ferrule conductor length) Ferrules not used: 8 mm

Use wiring crimp terminals and ferrule terminals of the specified size.

- After storing the product for a long time exceeding 1 year, perform, at a minimum, inspections of the operating characteristics, contact resistance, insulation resistance, and dielectric strength as well as evaluate the product under the working conditions.
- This Switch/Indicator is intended for indoor use only. Using the Switch/Indicator outdoors may result in failure.
- Do not wire anything to the release holes.
- Do not tilt or twist a flat-blade screwdriver while it is inserted into a release hole on the terminal block. The terminal block may be damaged.
- Insert a flat-blade screwdriver into the release holes at an angle. The terminal block may be damaged if you insert the screwdriver straight in.
- Do not allow the flat-blade screwdriver to fall out while it is inserted into a release hole.
- Do not bend a wire past its natural bending radius or pull on it with excessive force. Doing so may cause the wire disconnection.

A22NE-PD

A22NE-P

A22E

Common Accessories and Tools

Common Note

- Do not insert more than one wire into each terminal insertion hole.
- Do not mount A22N-P or A22NE-P Push-In Plus terminal switch blocks on A22N screw terminal blocks. Doing so may result in unsatisfactory performance.
- When mounting on a device with high airtightness, test operation in advance. There is a risk that the negative pressure will prevent the Operation Unit of from returning.
- In the case of loads where an inrush current occurs when the contact is opened or closed, the durability may reduce due to extreme wear on the contacts.
If necessary, insert a contact protection circuit.

Precautions for Correct Use

Wiring

1. Connecting Wires to the Push-In Plus Terminal Block

Part Names of the Terminal Block

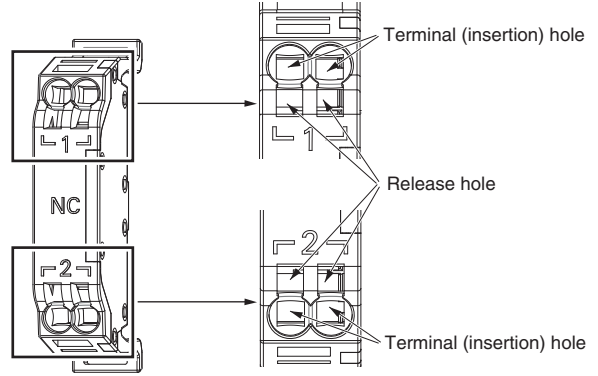

Connecting Wires with Ferrules and Solid Wires

- Insert the solid wire or ferrule straight into the terminal block until the end strikes the terminal block. The angle should be approximately 6°.
- If a wire is difficult to connect because it is too thin, use a flat-blade screwdriver in the same way as when connecting stranded wires.

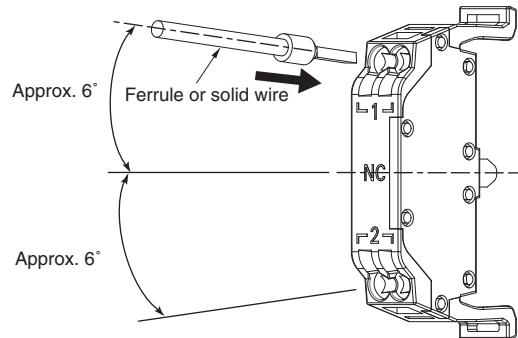

The wiring for the Lighting Unit and Switch Block (2 contacts) are the same as for the Switch Block (1 contact) shown in the above illustration.

Connecting Stranded Wires

Use the following procedure to connect the wires to the terminal block.

1. Hold a flat-blade screwdriver at an angle and insert it into the release hole.
The angle should be approximately 6°. If the flat-blade screwdriver is inserted correctly, you will feel the spring in the release hole.
2. With the flat-blade screwdriver still inserted into the release hole, insert the wire into the terminal hole until the end strikes the terminal block.
3. Remove the flat-blade screwdriver from the release hole.

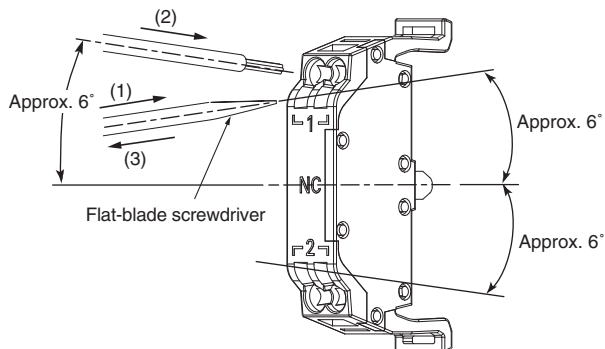

The wiring and screwdriver angles for the Lighting Unit and Switch Block (2 contacts) are the same as for the Switch Block (1 contact) shown in the above illustration.

Checking Connections

- After the insertion, pull gently on the wire to make sure that it will not come off and it is securely fastened to the terminal block.
- If you use a ferrule with a conductor length of 10 mm, part of the conductor may be visible after the ferrule is inserted into the terminal block, but the product insulation distance will still be satisfied.

2. Removing Wires from the Push-In Plus Terminal Block

Use the following procedure to remove wires from the terminal block. The same method is used to remove stranded wires, solid wires, and ferrules.

1. Hold a flat-blade screwdriver at an angle and insert it into the release hole. The angle should be approximately 6°.
2. With the flat-blade screwdriver still inserted into the release hole, remove the wire from the terminal insertion hole.
3. Remove the flat-blade screwdriver from the release hole.

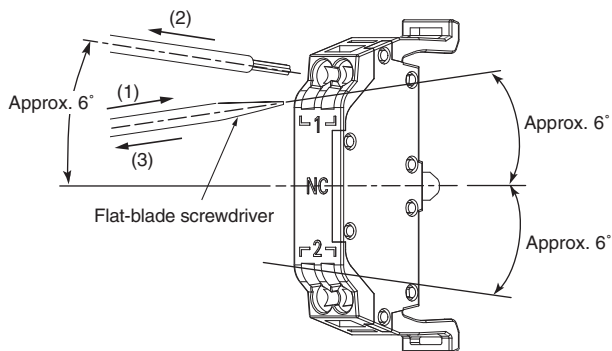

The wiring and screwdriver angles for the Lighting Unit and Switch Block (2 contacts) are the same as for the Switch Block (1 contact) shown in the above illustration.

3. Recommended Ferrules and Crimp Tools
Coating peeling amount

Recommend Wire Type	Stripping length (Ferrules not used)
0.25 to 1.5 mm ² /AWG 24 to AWG 16	8 mm

Recommended ferrules

Applicable wire		Ferrule conductor length (mm)	Stripping length (mm) (Ferrules not used)	Recommended ferrules		
(mm ²)	(AWG)			Phoenix Contact product	Weidmuller product	Wago product
0.25	24	8	10	AI 0, 25-8	H0.25/12	216-301
		10	12	AI 0, 25-10	---	---
0.34	22	8	10	AI 0, 34-8	H0.34/12	216-302
		10	12	AI 0, 34-10	---	---
0.5	20	8	10	AI 0, 5-8	H0.5/14	216-201
		10	12	AI 0, 5-10	H0.5/16	216-241
0.75	18	8	10	AI 0, 75-8	H0.75/14	216-202
		10	12	AI 0, 75-10	H0.75/16	216-242
1/1.25	18/17	8	10	AI 1-8	H1.0/14	216-203
		10	12	AI 1-10	H1.0/16	216-243
1.25/1.5	17/16	8	10	AI 1, 5-8	H1.5/14	216-204
		10	12	AI 1, 5-10	H1.5/16	216-244
Recommended Crimp Tools				CRIMPFOX6 CRIMPFOX6T-F CRIMPFOX10S	PZ6 roto	Variocri mp4

- Note:**
1. Make sure that the outer diameter of the wire coating is smaller than the inner diameter of the insulation sleeve of the recommended ferrule.
 2. Make sure that the ferrule processing dimensions conform to the following figures.

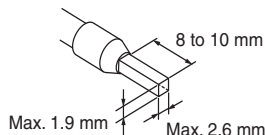

Recommended Flat-Blade Screwdrivers

Use a flat-blade screwdriver to connect and remove wires. Use one of the following flat-blade screwdrivers. The following table shows manufacturers and models as of 2015/Dec.

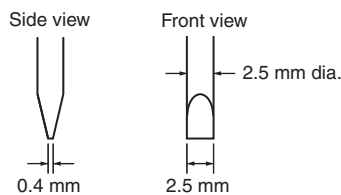

Model	Manufacture
ESD 0,40 × 2,5	Wera
SZS 0,4 × 2,5 SZF 0-0,4 × 2,5 *	Phoenix Contact
0,4 × 2,5 × 75 302	Wiha
AEF.2,5 × 75	Facom
210-719	Wago
SDI 0,4 × 2,5 × 75	Weidmuller

* The SZF 0-0,4 × 2,5 (manufactured by Phoenix Contact) can be procured through an OMRON exclusive purchase form (XW4Z-00B).

- After wiring the Switch/Indicator, provide a sufficient insulation distance.

LED Lamps

- A current-limiting resistor is built in the LED lamp, so the installation of an external resistance is not required.
- Lighting malfunction of the LED lamp
A micro-current of approximately 0.1 mA or less is sufficient to turn on the LED lamps. Take a countermeasure like adding a resistor to prevent mis-lighting in parallel to the LED lamp.
The micro-current varies with the machine (leak current or stray capacity between cables, etc.). Select resistance value and allowable power consumption that meet the actual current.

(Example of lighting malfunction prevention circuit)

When using a 24-VAC/VDC lighted unit

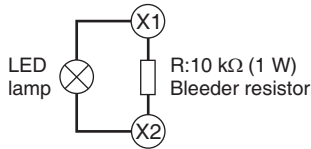

Be sure to read the "Safety Precautions" on page 56.

A22E

A22NE-PD

A22NE-P

A22E

Common Accessories and Tools

Common Note

Install in 22-dia. or 25-dia. Panel Cutout

(When Using a Ring)

- Increase wiring efficiency with three-row mounting of Switch Units. (with non-lighted Switch Blocks, three Units can be mounted for multiple contacts).
- Mounted using either open-type (fork-type) or closed-type (round-type) crimp terminals.
- Oil-resistant to IP65 (non-lighted models) / IP65 (lighted models).
- A lock plate is provided as a standard feature to ensure that the control box and switch are not easily separated.

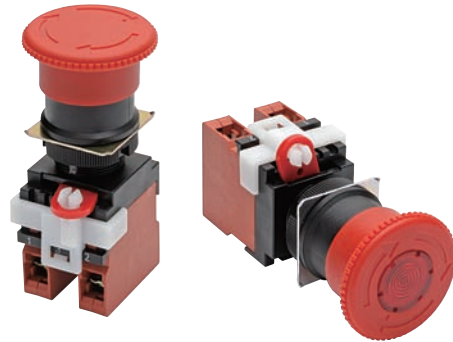

Be sure to read the "Safety Precautions" on pages 50 and 56.

For the most recent information on models that have been certified for safety standards, refer to your OMRON website.

Model Number Structure

Model Number Legend (Completely Assembled) Shipped as a set which includes the Operation Unit, LED Lamp (lighted model only), Mounting Latches, Switch Block, and Lock Plate



1. Lighted/Non-lighted

Code	Description
None	Non-lighted
L	Lighted *

* Lighted Emergency Stop Switches are available only for the medium (M). turn-reset models.

2. Operation Unit size (diameter)/Reset function

Code	Size	Description
MP	40 dia.	Pull-reset
S	30 dia.	
M	40 dia.	Turn-reset
L	60 dia.	

3. LED Lamp voltage

Lighting unit (Direct lighting)

Code	Description	Operating Voltage
None	Non-lighted	---
6 A	Lighted (LED) *	6 VAC/DC
12 A		12 VAC/DC
24 A		24 VAC/DC

Lighting unit (Voltage-reduction lighting)

Code	Description	Operating Voltage
T1	Lighted (LED) *	100 VAC
T2	Lighted (LED) *	200 VAC

* Equipped with 24-VAC/DC LED.

4. Contacts

Code	Number of Switch Blocks		Unit position					
			Non-lighted			Lighted		
	NO	NC	1	2	3	1	2	3
01	0	1	NC	---	---	NC	---	Lighting unit
11	1	1	NC	NO	---	NC	NO	Lighting unit
02	0	2	NC	NC	---	NC	NC	Lighting unit
12	1	2	NC	NO	NC	---		
03	0	3	NC	NC	NC	---		

Note 1. NO: 1a-contact NC: 1b-contact
 2. For details on the unit position, refer to the figure below.

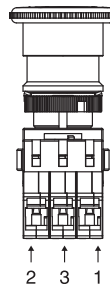

5. Configuration

Code	Configuration
None	Switch only
B	Switch with Integrated Control Box

6. Configuration





Code	Configuration
None	Neither "EMO" nor "EMS" printed, arrows engraved in red.
EMO	"EMO" and arrows printed in white.
EMO-RD	"EMO" printed in white, arrows engraved in red.
EMS	"EMS" and arrows printed in white.
EMS-RD	"EMS" printed in white, arrows engraved in red.

A22E

Ordering Information

List of Models (Completely Assembled)

Non-lighted Models (Without EMO/EMS Indication)



Appearance	Operation	Degree of Protection	Contact configuration *1	Set Model	Color of cap
	40-dia. head Medium Pull-reset A22E-MP	IP65 oil-resistant models	1NC (1)	A22E-MP-01	Red
			1NC, 1NO (2)	A22E-MP-11	
			2NC (2)	A22E-MP-02	
	30-dia. head Small Turn-reset A22E-S		1NC (1)	A22E-S-01 *2	
			1NC, 1NO (2)	A22E-S-11 *2	
			2NC (2)	A22E-S-02 *2	
			2NC, 1NO (3)	A22E-S-12 *2	
			3NC (3)	A22E-S-03 *2	
				40-dia. head Medium Turn-reset A22E-M	
1NC, 1NO (2)	A22E-M-11 *2				
2NC (2)	A22E-M-02 *2				
2NC, 1NO (3)	A22E-M-12 *2				
3NC (3)	A22E-M-03 *2				
	60-dia. head Large Turn-reset A22E-L	1NC (1)			A22E-L-01 *2
		1NC, 1NO (2)	A22E-L-11 *2		
		2NC (2)	A22E-L-02 *2		

*1. The number in parentheses () indicates the number of switch units.

*2. Models with Korean S-mark certification

Note: Yellow cap models are also available (not for emergency stop use). Contact your OMRON representative.

Non-lighted Models (With EMO/EMS Indication)

Appearance	Operation	Degree of Protection	Contact configuration *1	Set Model	Color of cap
	40-dia. head Medium Turn-reset With EMO Indication	IP65 oil-resistant models	1NC (1)	A22E-M-01-EMO *2	Red
				A22E-M-01-EMO-RD	
			1NC, 1NO (2)	A22E-M-11-EMO *2	
				A22E-M-11-EMO-RD	
			2NC (2)	A22E-M-02-EMO *2	
				A22E-M-02-EMO-RD	
	40-dia. head Medium Turn-reset With EMS Indication		2NC, 1NO (3)	A22E-M-12-EMO *2	
				A22E-M-12-EMO-RD	
			3NC (3)	A22E-M-03-EMO *2	
				A22E-M-03-EMO-RD	
			1NC (1)	A22E-M-01-EMS *2	
				A22E-M-01-EMS-RD	
		1NC, 1NO (2)	A22E-M-11-EMS *2		
			A22E-M-11-EMS-RD		
		2NC (2)	A22E-M-02-EMS *2		
			A22E-M-02-EMS-RD		
		2NC, 1NO (3)	A22E-M-12-EMS *2		
			A22E-M-12-EMS-RD		
		3NC (3)	A22E-M-03-EMS *2		
			A22E-M-03-EMS-RD		

*1. The number in parentheses () indicates the number of switch units.

*2. Models with Korean S-mark certification

Note: The colors of switch blocks are as follows:

NO (a-contact): Black

NC (b-contact): Red

The above illustration shows the 2NC (2b-contact) configuration.

A22NE-PD



A22NE-P

A22E

Common Accessories and Tools

Common Note

Lighted Models

Appearance	Operation	Degree of Protection	Contact configuration *1	LED Lamp voltage	Set Model	Color of cap
	40-dia. head Push-lock Turn-reset Lighting unit (Direct lighting) A22E	IP65	1NC (1)	6 VAC/VDC	A22EL-M-6A-01 *2	Red
				12 VAC/VDC	A22EL-M-12A-01 *2	
				24 VAC/VDC	A22EL-M-24A-01 *2	
			1NC, 1NO (2)	6 VAC/VDC	A22EL-M-6A-11 *2	
				12 VAC/VDC	A22EL-M-12A-11 *2	
				24 VAC/VDC	A22EL-M-24A-11 *2	
			2NC (2)	6 VAC/VDC	A22EL-M-6A-02 *2	
				12 VAC/VDC	A22EL-M-12A-02 *2	
				24 VAC/VDC	A22EL-M-24A-02 *2	
	40-dia. head Push-lock Turn-reset Lighting unit (Voltage-reduction lighting) A22E	IP65	1NC (1)	100 VAC	A22EL-M-T1-01	
				200 VAC	A22EL-M-T2-01	
			1NC, 1NO (2)	100 VAC	A22EL-M-T1-11	
				200 VAC	A22EL-M-T2-11	
			2NC (2)	100 VAC	A22EL-M-T1-02	
				200 VAC	A22EL-M-T2-02	

*1. The number in parentheses () indicates the number of switch units.

*2. Models with Korean S-mark certification

Switch with Integrated Control Box

Appearance	Contact configuration (Number of switch blocks)	Model
	1NC (1)	A22E-M-01B *
	1NC, 1NO (2)	A22E-M-11B *
	2NC (2)	A22E-M-02B *

Note: The A22Z-B101Y Control Box is used.

* Models with Korean S-mark certification

Subassembled ... The Operation Unit, LED Lamp, Mounting Latches, and Switch Blocks can be ordered separately. Use them in combination for models that are not available as assembled Units. These can also be used as inventory for maintenance parts.

Non-lighted

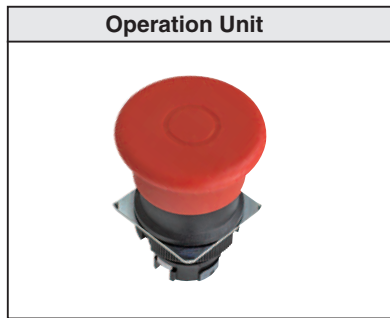



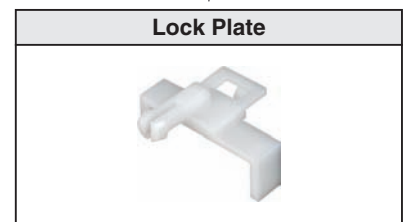
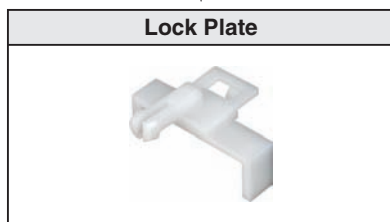
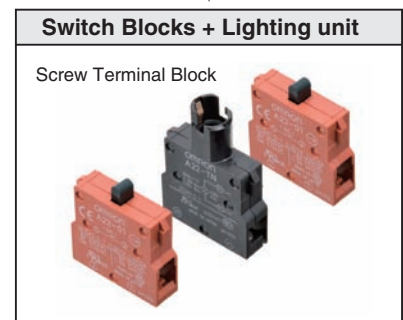
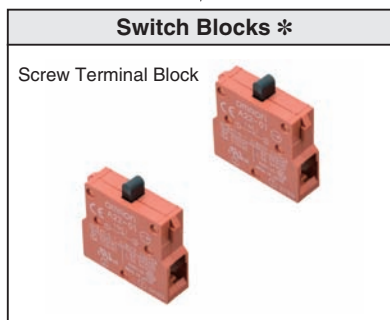
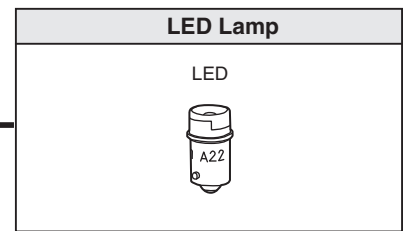
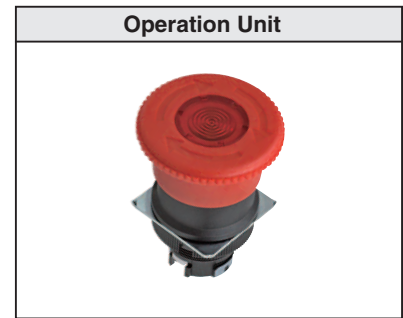



Lighted



* Up to three Switch Blocks can be mounted for multiple contacts.

Operation Unit
Non-lighted

Function	Sealing capability	Size	Small (30 dia.)	Medium (40 dia.)	Large (60 dia.)
		Single item order model			
Pull-reset	IP65 oil-resistant models		---	A22E-MP 	---
Turn-reset		A22E-S 	A22E-M 	A22E-L 	
	A22E-M-EMO A22E-M-EMO-RD 				
	A22E-M-EMS A22E-M-EMS-RD 				

Lighted

Function	Sealing capability	Size
		Medium (40 dia.)
Turn-reset	IP65	A22EL-M 

LED lamp

Appearance	LED light	Rated voltage	Model	
	Red	Standard	6 VAC/VDC	A22-6AR
			12 VAC/VDC	A22-12AR
			24 VAC/VDC	A22-24AR

Note: For a model with a Lighting unit (Voltage-reduction lighting), use the A22-24AR.

A22E

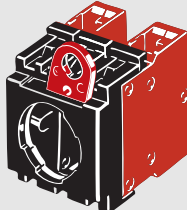
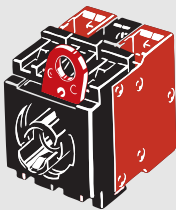

A22NE-PD

Switch
Non-lighted / Direct lighting

Classification		Non-lighted	Direct lighting
Appearance			
Contact specifications/ Configuration (Number of switch blocks)		Model	Model
For Standard loads	1NC (1)	A22-01M	A22L-01M
	1NC, 1NO (2)	A22-11M	A22L-11M
	2NC (2)	A22-02M	A22L-02M

A22NE-P

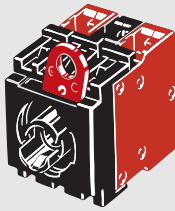
Voltage-reduction lighting (100 VAC, 200 VAC)

Classification		100 VAC, Lighted	200 VAC, Lighted
Appearance			
Contact specifications/ Configuration (Number of switch blocks)		Model	Model
For Standard loads	1NC (1)	A22L-01M-T1	A22L-01M-T2
	1NC, 1NO (2)	A22L-11M-T1	A22L-11M-T2
	2NC (2)	A22L-02M-T1	A22L-02M-T2







Note: For a model with a Lighting unit (Voltage-reduction lighting), use the A22-24AR.

A22E

Common Accessories and Tools

Common Note

Accessories (Order Separately)

Item	Appearance	Contact specifications		Model	Remarks
Switch Blocks (one contact)		1NO (Black)	Standard load	A22-10	Provided as standard. Order Switch Blocks only when adding or replacing them.
			Microload	A22-10S	
		1NC (Red)	Standard load	A22-01	
			Microload	A22-01S	
Switch Blocks (two contacts)		2NO (Black)	Standard load	A22-20	Order Switch Blocks only when adding or replacing them.
			Microload	A22-20S	
		2NC (Red)	Standard load	A22-02	
			Microload	A22-02S	
		1NC + 1NO Contact (Black/ Red)	Standard load	A22-11	
			Microload	A22-11S	
Lighting unit		Direct lighting		A22-TN	Used when changing the lighting method.
		Voltage-reduction lighting	100 VAC	A22-T1	
			200 VAC	A22-T2	
Mounting Latches		---		A22-3200	Provided as standard. Order Mounting Latches only when mounting Switch Blocks or Lighting Units that are purchased individually.
Lock Plate		---		A22Z-3380	Use to fix the lever on the Switch.
Control Boxes (Enclosures)		One hole, yellow box		A22Z-B101Y	Material: Polycarbonate resin. When using a Control Box, 2NO, 2NC, or 1NC + 1NO two-contact Switch Blocks are not supported. *
				A22Z-B201Y	

Note: For details on the accessories common to the screw terminal block types and push-in plus terminal block types, refer to "Common Accessories and Tools (Order Separately)" on page 51.

* The A22NZ-B101Y and A22NZ-B201Y Control Box cannot be used in combination with the A22Z-3476-1 90-dia. Legend Plates for Emergency Stop or the A22Z-EG□ E-stop Shrouds.

Specifications

Certified Standard Ratings

- UL, cUL (File No. E41515)
6 A at 220 VAC, 10 A at 110 VAC
- TÜV (EN60947-5-1) (Low Voltage Directive)
3 A at 220 VAC
- CCC (GB14048.5)
3 A at 240 VAC, 1.5 A at 24 VDC

Ratings

Contacts (Standard Load)

Rated carry current (A)	Rated voltage (V)	Rated current (A)			
		AC15 (Inductive load)	AC12 (Resistive load)	DC13 (Inductive load)	DC12 (Resistive load)
10	24 VAC	10	10	---	---
	110 VAC	5	10		
	220 VAC	3	6		
	380 VAC	2	3		
	440 VAC	1	2		
	24 VDC	---	---	1.5	10
	110 VDC			0.5	2
	220 VDC			0.2	0.6
	380 VDC			0.1	0.2

Note: 1. Rated current values are determined according to the testing conditions. The above ratings were obtained by conducting tests under the following conditions.

- Ambient temperature: 20°±2°C
- Ambient humidity: 65±5%
- Operating frequency: 20 operations/minute

2. Minimum applicable load: 10 mA at 5 VDC

Characteristics

Item	Type	Turn-reset		Pull-reset
		Non-lighted model	Lighted model	Non-lighted model
Allowable operating frequency	Mechanical	30 operations/minute (One operation consists of set and reset operations.)		
	Electrical	30 operations/minute (One operation consists of set and reset operations.)		
Insulation resistance		100 MΩ min. (at 500 VDC)		
Contact resistance		100 mΩ max. (initial value)		
Dielectric strength	Between terminals of same polarity	2,500 VAC, 50/60 Hz for 1 min.		
	Between each terminal and ground	2,500 VAC, 50/60 Hz for 1 min.		
Vibration resistance		10 to 55 Hz, 1.5-mm double amplitude (contact separation within 1 ms)		
Shock resistance	Destruction	1000 m/s ²		
	Malfunction	250 m/s ² max. (contact separation within 1 ms)		
Durability	Mechanical	300,000 operations min. (One operation consists of set and reset operations.)		
	Electrical	300,000 operations min. (One operation consists of set and reset operations.)		
Ambient operating temperature *1		-20 to +70°C	-20 to +55°C	-20 to +70°C
Ambient operating humidity		35 to 85% RH		
Ambient storage temperature		-40 to +70°C		
Degree of protection		IP65 oil-resistant models *2 *3	IP65 *2	IP65 oil-resistant models *2 *3
Electric shock protection class		Class II		
PTI (tracking characteristic)		175		
Degree of contamination		3 (EN60947-5-1)		
Minimum direct opening stroke		11 mm		
Minimum direct opening force		45 N		
Conditional short-circuit current		100 A (EN 60947-5-1)		
Weight (for a 40-dia. head 1NC/1NO Operation Unit)		Approx. 65 g	Approx. 80 g	Approx. 100 g

*1. With no icing or condensation.

*2. The degree of protection from the front of the panel.

*3. The degree of protection is IP65 even with an integrated control box, but the system is not oil resistant.

Certified Standards

Certification body	Standards	File No.
UL *1	UL508, C22.2 No.14	E41515
TÜV SÜD	EN60947-5-1 (Certified direct opening), EN60947-5-5	Consult your OMRON representative for details.
CQC (CCC)	GB14048.5	2003010303070635
KOSHA *2	EN60947-5-1	Consult your OMRON representative for details.

Note: 1. Only models with NC contacts have a direct opening mechanism.

2. A fuse is not provided.

*1. UL-certification for CSA C22.2 No. 14 has been obtained.

Certification has been obtained for individual Switch Blocks and Lighting Units.

*2. Some models have been certified.

LED Lamp

Rated voltage	Operating voltage	Current value
6 VAC/VDC	6 VAC/VDC ± 5%	Approx. 8 mA
12 VAC/VDC	12 VAC/VDC ± 5%	
24 VAC/VDC	24 VAC/VDC ± 5%	

Voltage-reduction lighting

Rated voltage	Operating voltage	Rated current	Applicable lamp (BA9S/Base: 13)
110 VAC	100 VAC (95 to 115 V)	Approx. 8 mA	LED lamp A22-24A□
220 VAC	200 VAC (190 to 230 V)		

Operating Characteristics

Item	Turn-reset	Pull-reset
Total travel force (TTF)	44.1 N max.	58.8 N max.
Return force (RF)	0.25 N·m max. *	58.8 N max.
Total travel (TT)	10 ±1 mm	5.5 ±1 mm

* Rotation torque value.

Terminal Arrangement (BOTTOM VIEW)

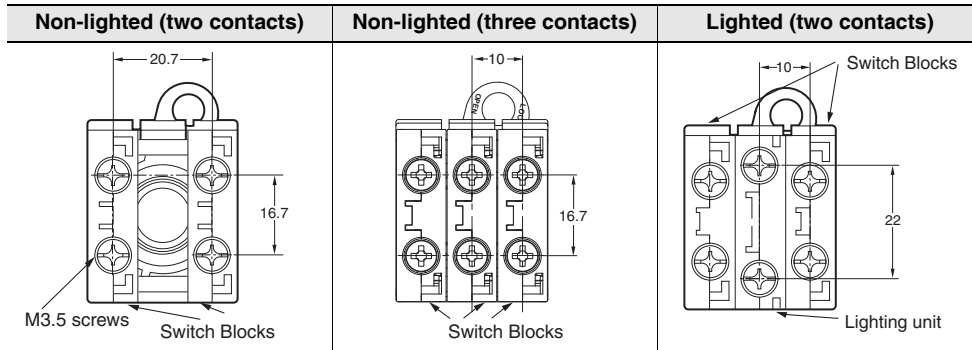

Terminal connection

Type	Terminal Connection (BOTTOM VIEW)									
	1NC, 1NO (two contacts)		2NC (two contacts)		2NC, 1NO (three contacts)			3NC (three contacts)		
Non-lighted	NC 1 2	NO 3 4	NC 1 2	NC 1 2	NC 1 2	NC 1 2	NO 3 4	NC 1 2	NC 1 2	NC 1 2
Lighted with Direct lighting	1 2	X1 X2	3 4	1 2	X1 X2	1 2				
Lighted with Voltage-reduction lighting	1 2	X1 X2	3 4	1 2	X1 X2	1 2				

Note: The above terminal connection diagrams are examples of the number of contacts.

Terminal wiring drawings of two-contact Switch Units

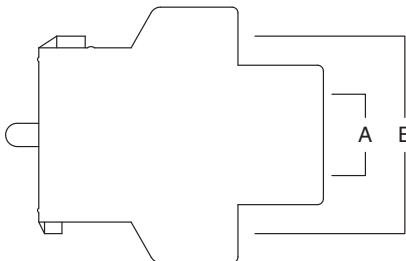

Type	Terminal Connection (BOTTOM VIEW)		
	2NC (two contacts)	2NO (two contacts)	1NC, 1NO (two contacts)
A	21 22	23 24	23 24
B	11 12	13 14	11 12

A22E

Structure and Nomenclature

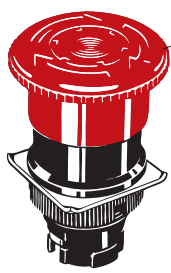

Operation Unit
Color: Red
 Non-lighted
 LED lighting



Lamp
Light source
 • LED Lamp

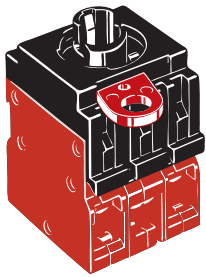

Switch
 Mounting Latches
 Switch Blocks
 Lighting unit

Contact Ratings
 10 A at 100 VAC (resistive load)
 10 A at 24 VDC (resistive load)

Lighting Method
 Non-lighted
 Lighted (Direct lighting)
 Lighted (Voltage-reduction lighting)

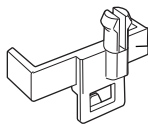

Lock Plate (Attached with the Operation Unit)
 (Refer to the "Mounting the Lock Plate" on page 50 for use.)

Dimensions

(Unit: mm)

Non-lighted Models

A22E-MP

Medium Pull-reset (40-dia.) Degree of Protection: IP65 oil-resistant models

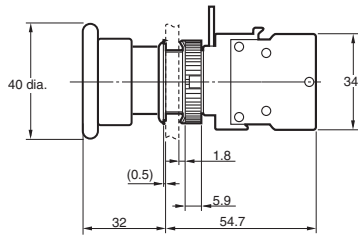
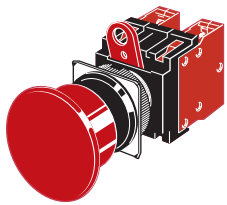

A22E-S

Small Turn-reset (30-dia.) Degree of Protection: IP65 oil-resistant models

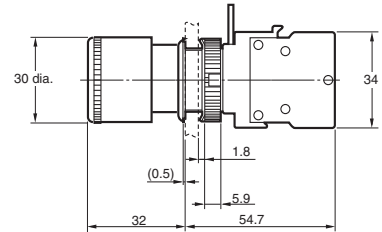

A22E-M

Medium Turn-reset (40-dia.) Degree of Protection: IP65 oil-resistant models

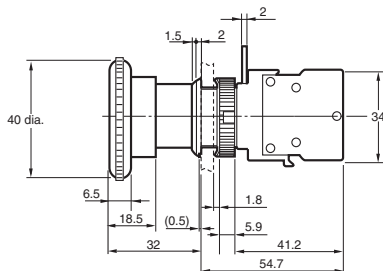
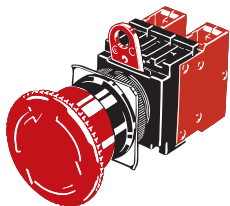

A22E-L

Large Turn-reset (60-dia.) Degree of Protection: IP65 oil-resistant models

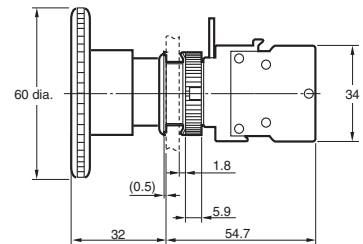
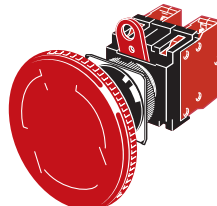

Note: The dimensions are the same as for EMO/EMS indication models.

Note: Unless otherwise specified, a tolerance of ± 0.8 mm applies to all dimensions.

Common Accessories and Tools

Common Note

Lighted Model

A22EL-M
Medium Turn-reset (40-dia.) Degree of Protection:
IP65 oil-resistant models

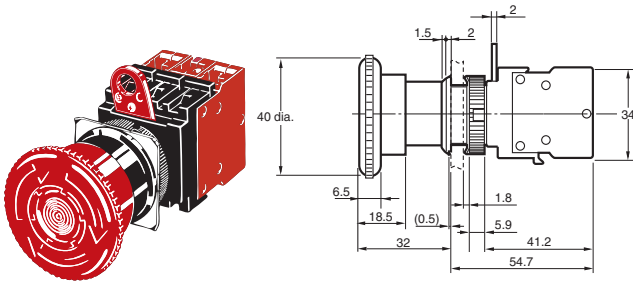

Switch dimensions when mounted to a 2NO (2NC) one-piece switch block

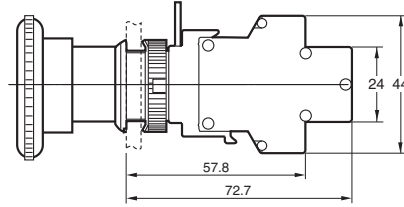

Note: The operation unit is an example for the A22E-M.

Note: Unless otherwise specified, a tolerance of ± 0.8 mm applies to all dimensions.

Accessories (Order Separately)

LED Lamp

A22-6□, 12□, 24□

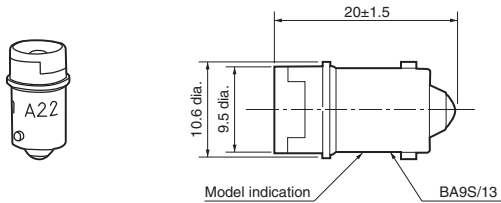

Control Box

A22Z-B101Y (1-hole)

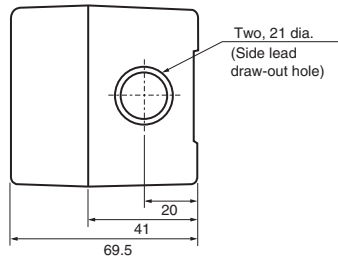
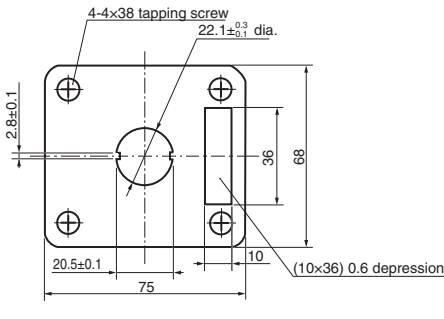

Cable Draw-out Hole (Top View)

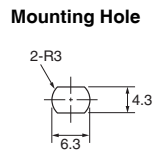
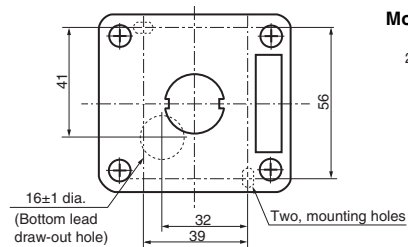

Control Box

A22Z-B201Y (1-hole)

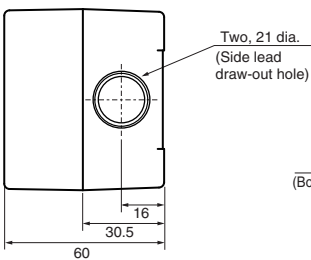
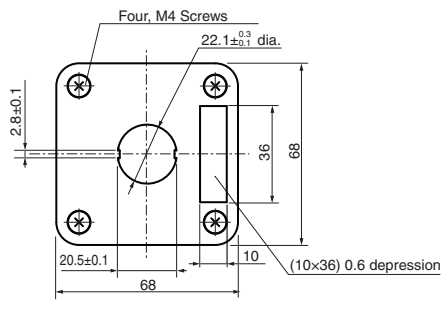

Cable Draw-out Hole (Top View)

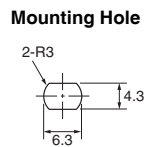
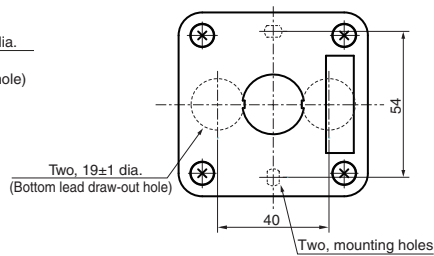

Note: For details on the accessories common to the screw terminal block types and push-in plus terminal block types, refer to "Common Accessories and Tools (Order Separately)" on page 51.

Installation

Mounting to the Panel

(1) Preparing the Panel

- The panel dimensions are shown below.
- The panel thickness must be 1 to 5 mm.

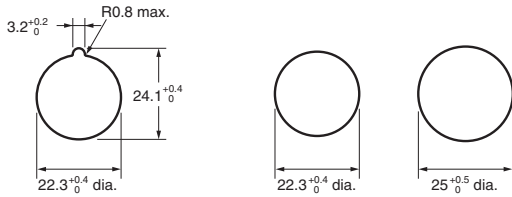

With Lock Ring

Without Lock Ring

- Always use a 25-mm-dia. A22Z-R25 Lock Ring for a 25-mm-dia. hole. IP65 degree of protection will be lost if the 25-mm-dia. Lock Ring is not used because of the larger size of a 25-mm-dia. hole.
- When painting or coating the panel, make sure that the specified panel dimensions apply to the panel after painting or coating.

(3) Mounting the Switch on the Operation Unit

- Insert the Operation Unit into the Switch Unit, aligning the arrow mark inscribed on the Case with the lever on the Switch Blocks, then move the lever in the direction indicated by the arrow in the following figure.

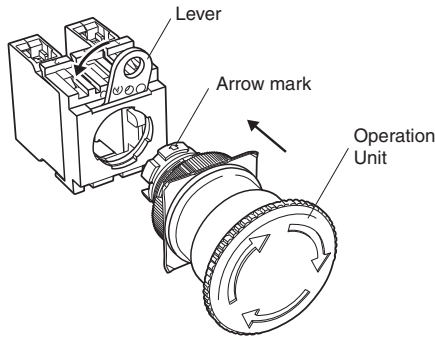

(4) Removing the Switch

- Move the lever in the direction indicated by the arrow in the following figure, then pull the Operation Unit or the Switch Blocks. Since the lever has a hole with an inside diameter of 6.5 mm, the lever can be moved in the specified direction by inserting a screwdriver into the hole and then moving the screwdriver.

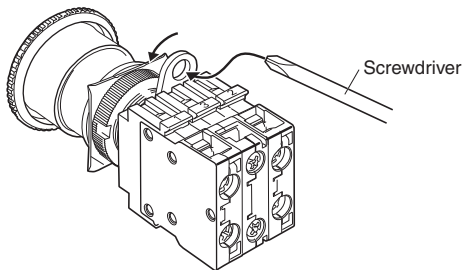

(2) Mounting the Operation Unit on the Panel

- Insert the Operation Unit from the front surface of the panel, insert the Lock Ring and the Tightening Nut from the terminal side, then tighten the Ring. Before tightening, check that the rubber washer is present between the Operation Unit and the panel.
- Align the Lock Ring with the groove in the casing, then insert the Lock Ring so that its edge is located on the panel side.
- Tighten the Tightening Nut at a torque of 1.0 to 2.0 N·m.
- When using a Lock Ring, replace with the supplied Lock Ring, insert the projecting part into the lock slot, and then tighten the Tightening Nut.

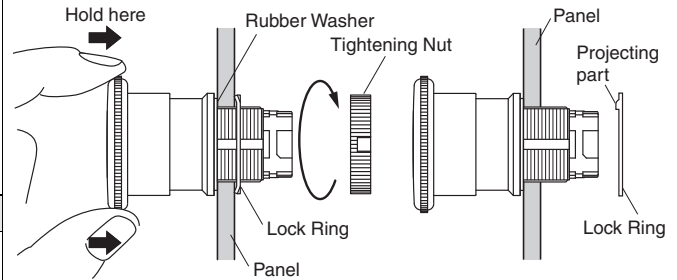

1. When the panel cutout dimension is 25 dia., remove the supplied rubber washer and mount the 25-dia. Ring as shown below. (Since the A22Z-R25 is not attached to the main body, order separately.) When using a Legend Plate (Order Separately), do not remove the rubber washer.

2. When the panel cutout dimension is 30 dia., use resin attachment A22Z-A30. Since it is not attached to the main body, order separately.

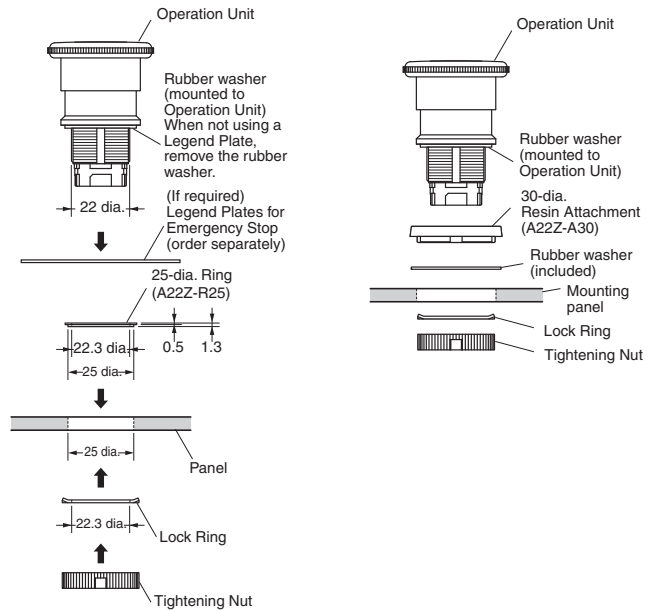

Assembling the Cap

Emergency Stop Switch

- Insert the protrusion of the Tightening Wrench (A22Z-3905) into the Cap slot and then turn to remove the Cap.

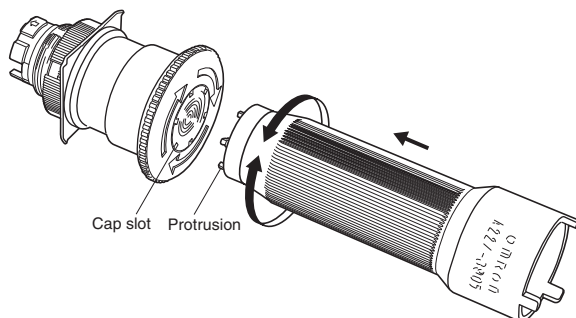

Installing/Replacing the LED Lamp

Installing/Replacing on the Switch

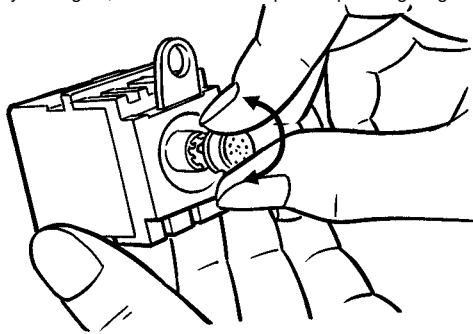

- Grip the lamp with your fingers, then rotate the lamp while pressing it against the Switch.

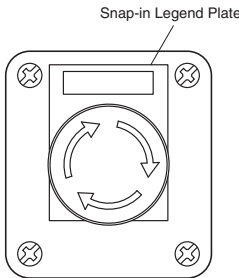
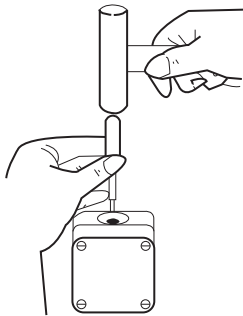
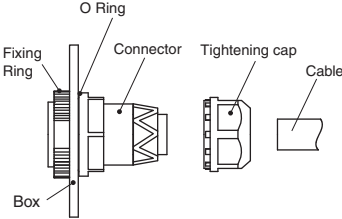

Control Box (Enclosure)

(1) Mounting the Switch	(2) Creating a Cable Port Hole	(3) Securing the Connector Cable						
<p>The Standard-size Legend Plate Frame can be mounted. Mount the Frame as shown in the following diagram. Mount the Switch in the same way as for an ordinary panel.</p> 	<p>Place the tip of a screwdriver on the surface where the cable port hole is to be created with the cover attached and strike the screwdriver to punch a hole. Attempts to punch a hole on the other side of the case will damage the Box.</p> 	<p>1. Insert the connector into the cable port hole in the Box and secure with the Mounting Ring inside the box. 2. Pass the tightening cap through the cable, insert the cable into the connector, and tighten the tightening cap to secure the cable.</p>  <table border="1" data-bbox="1149 1102 1487 1205"> <thead> <tr> <th>Cable diameter (mm)</th> <th>Connector</th> </tr> </thead> <tbody> <tr> <td>7 to 9 dia.</td> <td>A22Z-3500-1</td> </tr> <tr> <td>9 to 11 dia.</td> <td>A22Z-3500-2</td> </tr> </tbody> </table>	Cable diameter (mm)	Connector	7 to 9 dia.	A22Z-3500-1	9 to 11 dia.	A22Z-3500-2
Cable diameter (mm)	Connector							
7 to 9 dia.	A22Z-3500-1							
9 to 11 dia.	A22Z-3500-2							

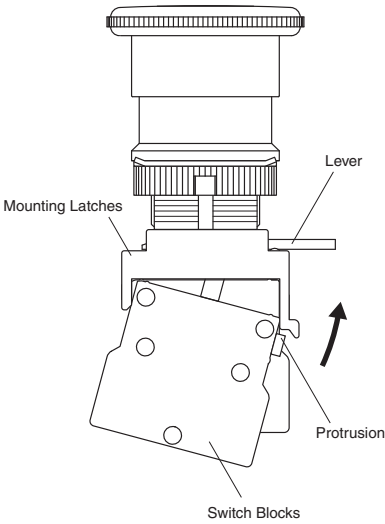
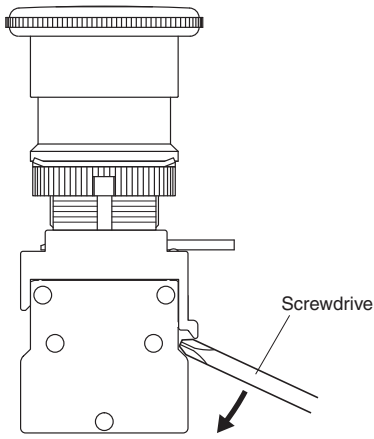
Installing/Removing the Switch Blocks

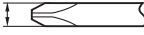
(1) Installing the Switch Blocks	(2) Removing the Switch Blocks
<ul style="list-style-type: none"> • Hook the small protrusion on the Mounting Latch into the groove on the other side of the lever, then push up the Switch Block in the direction indicated by the arrow in the figure below. 	<ul style="list-style-type: none"> • Insert a screwdriver between the Mounting Latch and the Switch Block, then push down the screwdriver in the direction indicated by the arrow in the following figure.  <p>Use either of the following screwdrivers.</p> <ul style="list-style-type: none"> ⊖ Flat-head screwdriver 3 to 6 mm  ⊕ Phillips screwdriver 3 to 6 mm dia. 

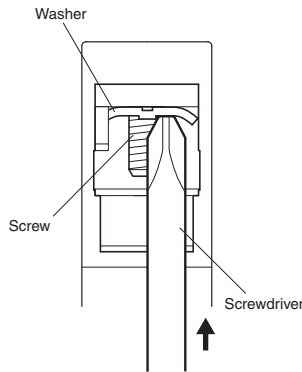

Wiring

Wiring Round Crimp Terminals
<ul style="list-style-type: none"> • Loosen the terminal screw from the Switch Unit until it completely comes off the groove, insert a screwdriver as shown in the following figure, then push up the washer in the direction indicated by the arrow to temporarily secure it. Now, a round crimp terminal can be connected. After inserting the terminal, tighten the screws to complete wiring. 

Safety Precautions

Be sure to read the precautions for **All PushButton Switches** in the website at: <http://www.ia.omron.com/>.

Indication and Meaning for Safe Use

 Warning	Indicates a potentially hazardous situation that, if not avoided, could result in serious injury or death. Additionally there may be significant property damage.
 CAUTION	Indicates a potentially hazardous situation which, if not avoided, may result in minor or moderate injury or in property damage.
Precautions for Safe Use	Supplementary comments on what to do or avoid doing, to use the product safely.

WARNING

Do not perform wiring with power supplied to the Switch/Indicator. Do not touch the terminals or other charged parts while power is being supplied. Doing so may result in electric shock.



Caution

If the Operation Unit is separated from the Socket Unit, the equipment will not stop, creating a hazardous condition. Secure the lever on the Socket Unit by using the A22Z-3380 Lock Plate so that the Operation Unit cannot be easily separated from the Socket Unit. (Refer to "Mounting the Lock Plate" at the below.)



Precautions for Correct Use

Mounting the Lock Plate

1. Confirm that the lever on the Mounting Latch is on the side where the Operation Unit is secured and then insert the protrusion on the Lock Plate into the hole in the lever on the Mounting Latch.
2. Press the hole on the Lock Plate onto the protrusion on the Mounting Latch until it clicks into place.

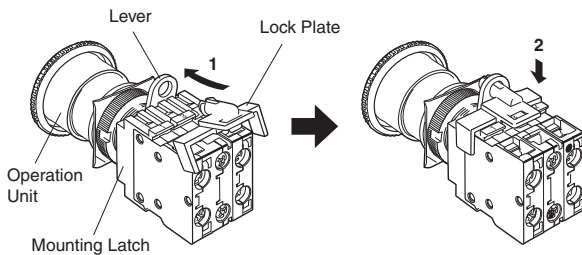

Wiring

- Terminal screws must be Phillips or slotted M3.5 screws with a square washer.
- The tightening torque is 1.08 to 1.27 N·m.
- Single wires, stranded wires, and crimp terminals can be connected to the Switch.
- Applicable Wiring Materials:
Twisted strands: 2 mm² max.
Solid wire: 1.6 mm dia. max.

Naked Crimp Terminals

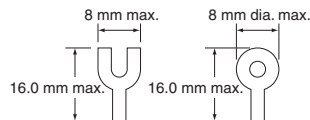

Crimp Terminals with Insulating Sheaths

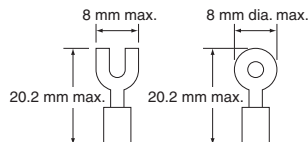

- After wiring the Switch, maintain an appropriate clearance and creepage distance.

LED Lamps

- The LED current-limiting resistor is built-in, so internal resistance is not required.
- If commercially available LEDs are used, select the ones that meet the following conditions:
Base: BA9S/13
Overall length: 26 mm max.
Power consumption: 2.6 W max.
When DC-specific LEDs are used, wire the Switch so that the X1 terminal is positive.
- Mis-lighting of the LED
The LED lights with approx. 0.1 mA or less of micro-current. Take a countermeasure like adding a resistor to prevent mis-lighting in parallel to the LED.
The micro-current varies with the machine (leak current or stray capacity between cables, etc.). Select resistance value and allowable power consumption that meet the actual current.

(Circuit example)

In case of using 24 VAC/VDC, Direct lighting

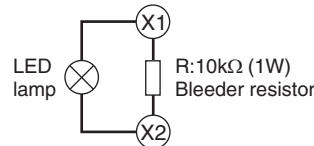

- Do not use a lamp that does not satisfy the rating.

Using the Microload

Contact failure may occur if a Switch designed for a standard load is used to switch a microload. Use Switches within the application ranges shown in the following graph. Even within the application range, insert a contact protection circuit, if necessary, to prevent the reduction of life expectancy due to extreme wear on the contacts caused by loads where inrush current occurs when the contact is opened and closed.

The minimum applicable load is the N-level reference value. This value indicates the malfunction reference level for the reliability level of 60% (λ_{60}) (conforming to JIS C5003). The equation, $\lambda_{60} = 0.5 \times 10^{-6}/\text{time}$ indicates that the estimated malfunction rate is less than 1/2,000,000 with a reliability level of 60%.

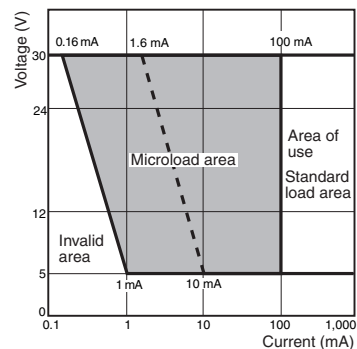











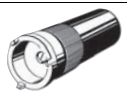

Be sure to read the "Safety Precautions" on page 56.

Common Accessories and Tools (Order Separately)

Ordering Information

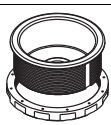
Common to Push-in Plus Terminal Block types (A22NE-PD/A22NE-P)/Screw Terminal Block types (A22E)

Item	Appearance	Classification	Model	Remarks	
Legend Plates for Emergency Stop		60-dia. black letters on yellow back-ground	A22Z-3466-1	Used in combination with the rubber packing when the level of protection is to be met between panels. *1	
		90-dia. black letters on yellow back-ground	A22Z-3476-1	Used in combination with the rubber packing when the level of protection is to be met between panels. *1 *3	
		60-dia. black letters on yellow background	A22Z-3466-2	Used in combination with the rubber packing when the level of protection is to be met between panels. *1	
Hole Plug		Round	A22Z-3530	Used for covering the panel cutouts for future panel expansion. Black color.	
Connectors		Applicable cable diameter	7 to 9 dia.	A22Z-3500-1	Plastic connector used to extend a cable from the Switch Box. (Refer to page 15, 32, and 49).
			9 to 11 dia.	A22Z-3500-2	
25-dia. Ring		---	A22Z-R25	Use when mounting to a panel with a 25-dia. hole. (Refer to page 15, 31, and 48). Material: Rubber, Level of protection: IP65	
30-dia. Resin Attachment		---	A22Z-A30	Use when mounting to a panel with a 30-dia. hole. (Refer to page 15, 31, and 48). A rubber packing is provided with the product.	
Lock Ring		---	A22Z-3360	The body is equipped with a Lock Ring. This Lock Ring is used when a more secure lock feature is required. (Refer to page 15 and 31).	
Tightening Tool		---	A22Z-3905	Used for tightening the tightening nut from the back side of the panel, and for removing the cap in lighted models.	
E-stop Shroud for EMO, Yellow		---	A22Z-EG1	Provides SEMI-S2/SEMATECH APPLICATION GUIDE FOR SEMI-S2 compatibility. The SEMI-S2-compatible Shroud and legend plate for EMERGENCY OFF come as a set. Use with an A22E Emergency Stop Switch (for emergency shutoff) *2 *3	
E-stop Shroud for EMO, Yellow		Legend plate for EMERGENCY OFF is not included.	A22Z-EG10	Provides SEMI-S2/SEMATECH APPLICATION GUIDE FOR SEMI S2 compatibility. Use with an A22E with EMO indication. (for emergency off) *3	
E-stop Shroud for EMS, White		---	A22Z-EG1-W	Provides SEMI-S2/SEMATECH APPLICATION GUIDE FOR SEMI-S2 compatibility. The SEMI-S2-compatible Shroud and legend plate for EMERGENCY STOP come as a set. Use with an A22E Emergency Stop Switch. (for emergency stop) *2 *3	
E-stop Shroud for EMS, White		Legend plate for EMERGENCY STOP is not included.	A22Z-EG10-W	Provides SEMI-S2/SEMATECH APPLICATION GUIDE FOR SEMI S2 compatibility. Use with an A22E with EMS indication. (for emergency stop) *3	
E-stop Shroud, Yellow		Spacer Unit is not included.	A22Z-EG2	SEMI-S2/SEMATECH APPLICATION GUIDE FOR SEMI S2-compatible Shroud. (for emergency shutoff) *2 *3 Use together with an A22E Emergency Stop Switch.	
		One Spacer Unit is included.	A22Z-EG21		
		Two Spacer Units are included.	A22Z-EG22		
E-stop Shroud for EMO, Yellow		---	A22Z-EG3	Provides SEMI-S2/SEMATECH APPLICATION GUIDE FOR SEMI-S2 compatibility. The SEMI-S2-compatible Shroud and legend plate for EMERGENCY OFF come as a set. Use with an A22E Emergency Stop Switch. (for emergency shutoff) *2 *3	
Rubber Packing		-	A22Z-R	Used together with accessories. Contains 10 packings.	

*1. If you use Legend Plates for Emergency Stop, set the thickness of the panels between 1 to 4 mm.

*2. These Shrouds are for use with the equipment only that conforms to SEMI standards. Do not use them for any other applications (e.g. emergency stop switches for machines or devices such as Machine tools, Printing presses, Industrial machinery, etc).

*3. The Control Boxes cannot be used in combination with the A22Z-3476-1 Legend Plates for Emergency Stop or the A22Z-EG□ E-stop Shrouds.

Note: 1. Accessories for A22Z-EG1: one "EMERGENCY OFF" label, two rubber packings, and one lock ring

2. Accessories for A22Z-EG10: one rubber packing and one lock ring (without label)

A22NE-PD

A22NE-P

A22E

Common Accessories and Tools

Common Note

A22NE-PD/A22NE-P/A22E

Dimensions

(Unit: mm)

Screw Terminal Block Type/Push-in Plus Terminal Block Type

**Hole Plug
Round A22Z-3530**

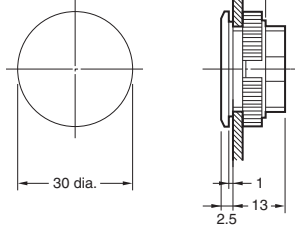

**30-dia. Resin Attachment
A22Z-A30**

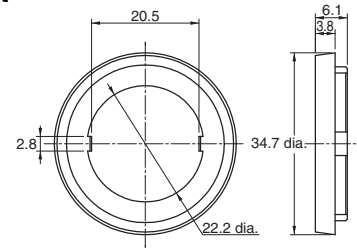
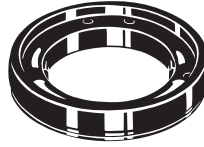

Legend Plates for Emergency Stop

A22Z-3476-1 (90 dia.)

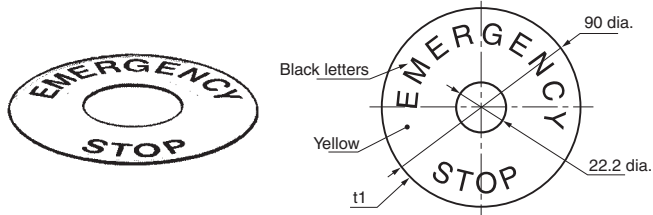

A22Z-3466-1 (60 dia.)

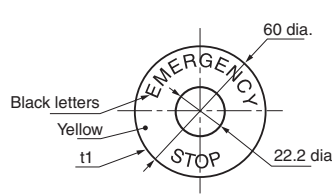

A22Z-3466-2 (60 dia.)

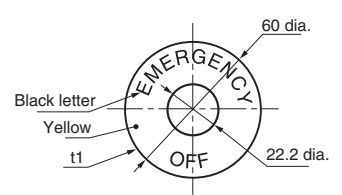

**Lock Ring
A22Z-3360**

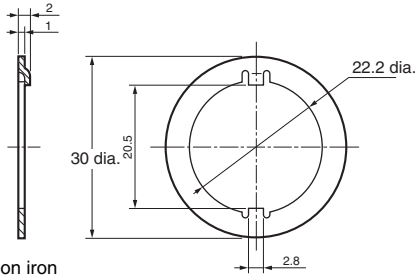
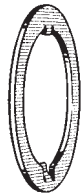

Material: Nickel plated on iron

**25-dia. Ring
A22Z-R25**

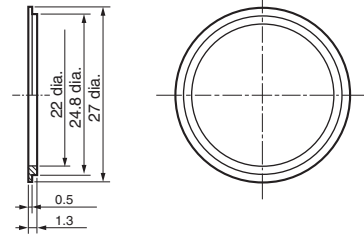

Material: NBR (black)

**Tightening Tool
A22Z-3905**

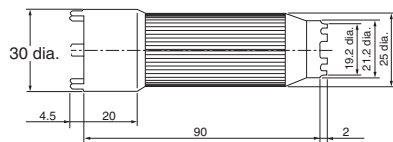
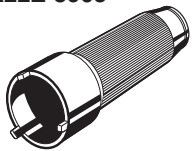

**Rubber Packing
A22Z-R**

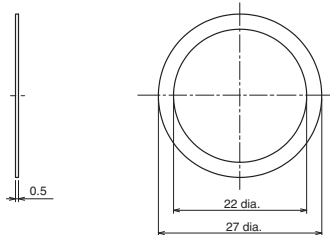
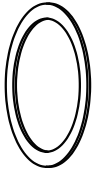

**Connector
A22Z-3500**

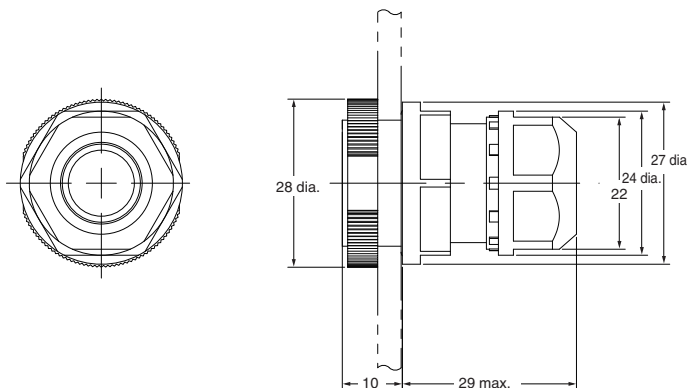

Common Accessories and Tools

Common Note

Common E-stop Shrouds

A22Z-EG1, A22Z-EG1-W, A22Z-EG10, A22Z-EG10-W

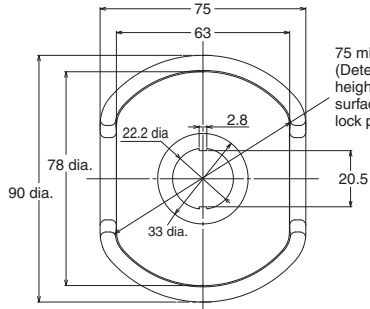

75 min.
(Determined by the height of the Switch surface in the lock position.)

Screw Terminal Block type Mounting a 1-pole Switch Unit

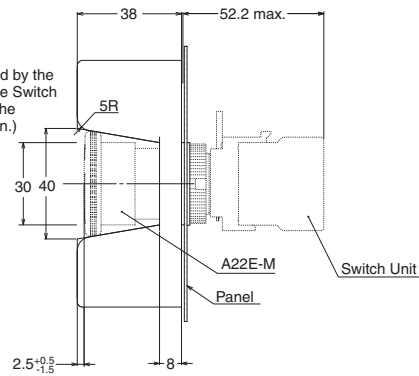

- Note:**
1. The dimensions of the Shroud conform to the specifications of the SEMATECH Application Guide for SEMI S2-93.
 2. The Shroud is not provided with the Switch.

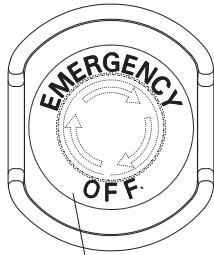

"EMERGENCY STOP" is indicated on A22Z-EG1-W. Legend plate is not provided with A22Z-EG10 and A22Z-EG10-W.

Push-in Plus Terminal Block type Mounting a 1-pole Switch Unit

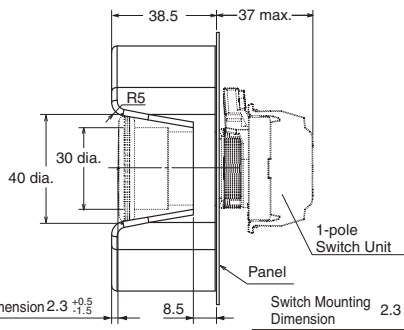

Push-in Plus Terminal Block type Mounting a 2-pole Switch Unit

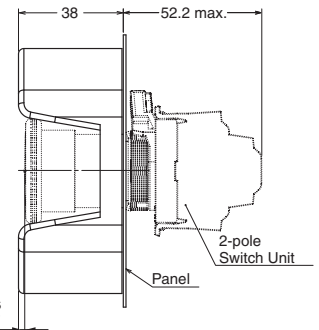

Switch Mounting Dimension $2.3^{+0.5}_{-1.5}$

Switch Mounting Dimension $2.3^{+0.5}_{-1.5}$

Panel Cutout Dimensions

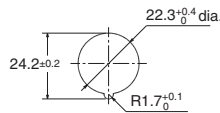

Model	Allowable panel thickness [mm]
A22NE-PD series	1 to 1.8
A22NE-P series	1 to 2.0
A22E series	

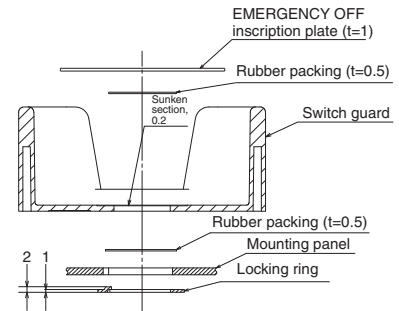

E-stop Shrouds

A22Z-EG2, A22Z-EG21, A22Z-EG22

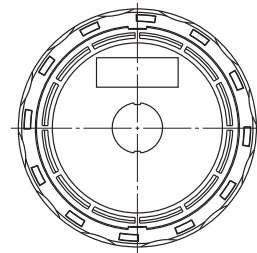
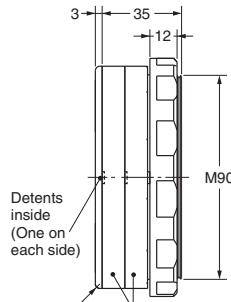
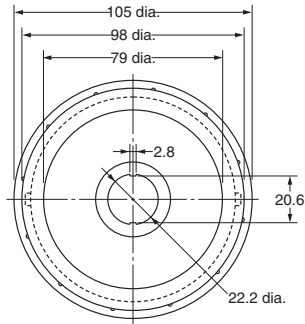
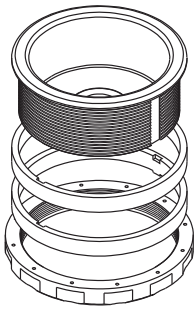

The number of spacers depends on the model
 A22Z-EG2 : No Spacer
 A22Z-EG21 : 1 Spacer
 A22Z-EG22 : 2 Spacers

During spacer attachment

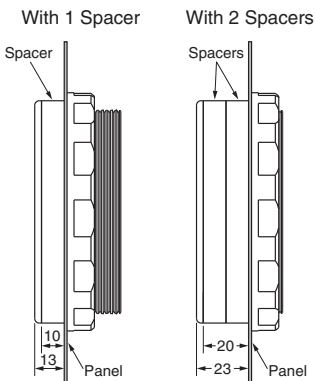

- Note:**
1. The dimensions of the Shroud conform to the specifications of the SEMATECH *Application Guide for SEMI S2-93*.
 2. The Shroud is not provided with the Switch.
 3. Tighten to a torque of 1.96 to 2.94 N-m.
 4. The allowable panel thicknesses are as follows:
 Without Spacers: $t=1.3$ to 22.5 mm
 With 1 Spacer: $t=1.3$ to 12.5 mm
 With 2 Spacers: $t=1.3$ to 2.5 mm

Screw Terminal Block Type Mounting a 1-pole Switch Unit *

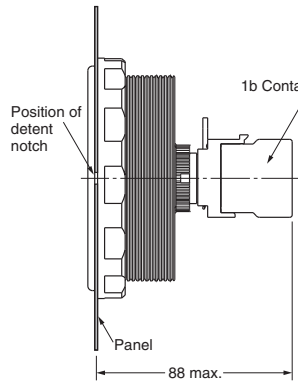

Screw Terminal Block Type Mounting a 2-pole Switch Unit *

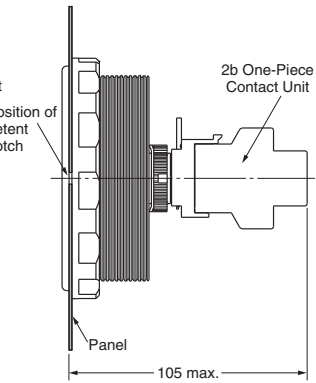

Push-in Plus Terminal Block Type Mounting a 1-pole Switch Unit *

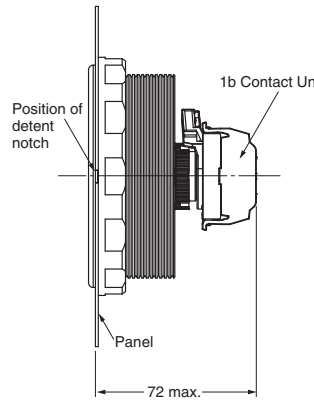

Push-in Plus Terminal Block Type Mounting a 2-pole Switch Unit *

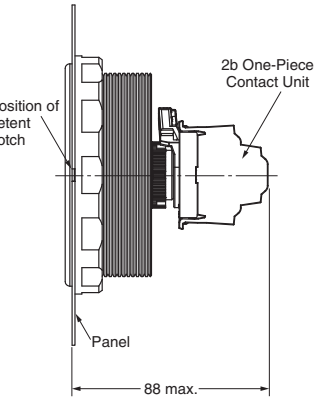

* These are the dimension from the front of the panel when the Switch Unit is attached.

**E-stop Shroud
A22Z-EG3**

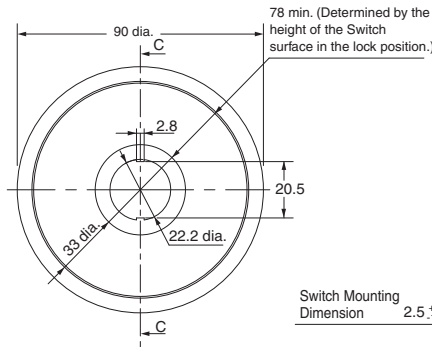

Screw Terminal Block Type Mounting a 1-pole Switch Unit

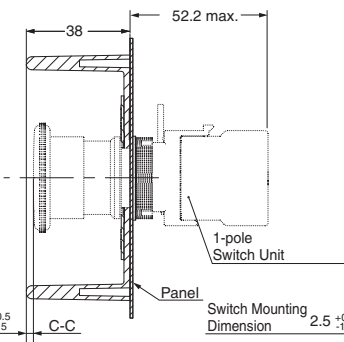

Screw Terminal Block Type Mounting a 2-pole Switch Unit

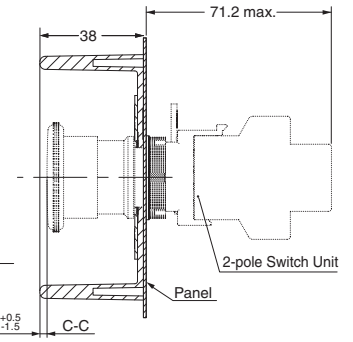

Push-in Plus Terminal Block Type Mounting a 1-pole Switch Unit

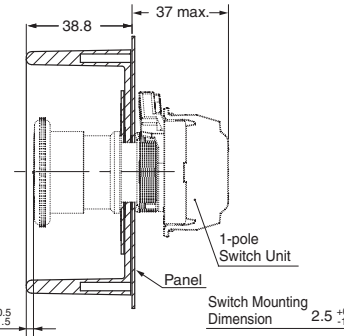

Push-in Plus Terminal Block Type Mounting a 2-pole Switch Unit

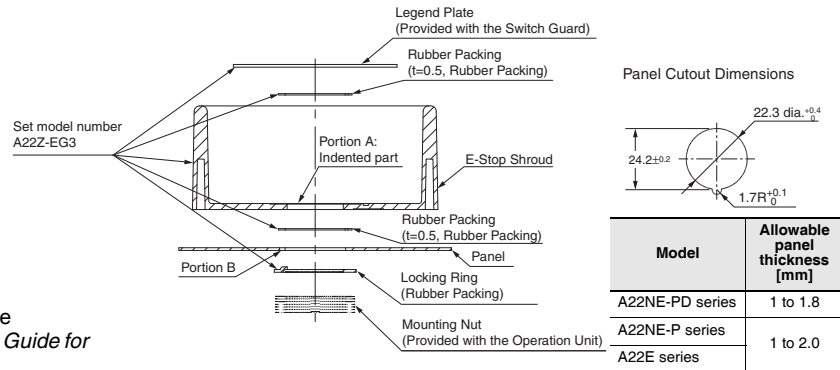
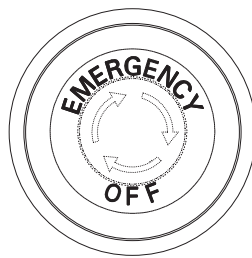
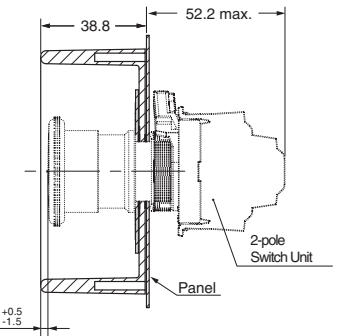

Panel Cutout Dimensions

Model	Allowable panel thickness [mm]
A22NE-PD series	1 to 1.8
A22NE-P series	1 to 2.0
A22E series	1 to 2.0

- Note:**
1. The dimensions of the Shroud conform to the specifications of the SEMATECH *Application Guide for SEMI S2-93*.
 2. The Shroud is not provided with the Switch.

A22NE-PD

A22NE-P

A22E

Common Accessories and Tools

Common Note

Safety Precautions

Be sure to read the precautions for **All PushButton Switches** in the website at: <http://www.ia.omron.com/>.

Indication and Meaning for Safe Use

Precautions for Safe Use	Supplementary comments on what to do or avoid doing, to use the product safely.

Precautions for Correct Use

Mounting

- Always make sure that the power is turned OFF before wiring the Switch. Also, do not touch the terminals or other current-carrying ports while power is being supplied. Electric shock may occur.
- Do not tighten the tightening nut more than necessary by using tools such as pointed-nose pliers. Doing so could damage the tightening nut. (The tightening torque is 1.0 to 2.0 N·m.)
- Recommended panel thickness: 1 to 5 mm.
- When mounting the caps after changing the LED or the caps, tighten the caps at a tightening torque of 0.49 to 0.78 N·m.

Operating Environment

- This model is designed with a protective structure so that it will not sustain damage if it is subjected to water from any direction to the front of the panel.
- The Switch is intended for indoor use only. Using the Switch outdoor may cause it to fail.

Others

- If the panel is to be coated, make sure that the panel meets the specified dimensions after coating.
- Due to the structure of the Switch, severe shock or vibration may cause malfunctions or damage to the Switch. Also, most Switches are made from resin and will be damaged if they come into contact with sharp objects. Particularly scratches on the Operation Unit may create visual and operational obtrusions. Handle the Switches with care, and do not throw or drop them.

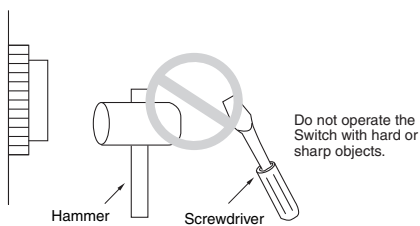
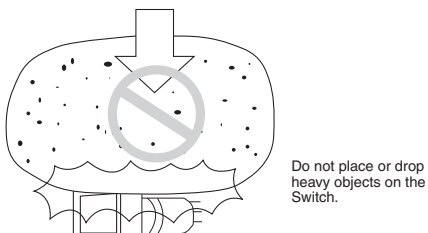
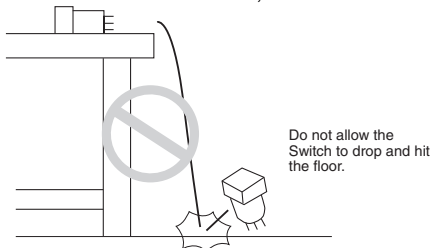

Terms and Conditions Agreement

Read and understand this catalog.

Please read and understand this catalog before purchasing the products. Please consult your OMRON representative if you have any questions or comments.

Warranties.

- (a) Exclusive Warranty. Omron's exclusive warranty is that the Products will be free from defects in materials and workmanship for a period of twelve months from the date of sale by Omron (or such other period expressed in writing by Omron). Omron disclaims all other warranties, express or implied.
- (b) Limitations. OMRON MAKES NO WARRANTY OR REPRESENTATION, EXPRESS OR IMPLIED, ABOUT NON-INFRINGEMENT, MERCHANTABILITY OR FITNESS FOR A PARTICULAR PURPOSE OF THE PRODUCTS. BUYER ACKNOWLEDGES THAT IT ALONE HAS DETERMINED THAT THE PRODUCTS WILL SUITABLY MEET THE REQUIREMENTS OF THEIR INTENDED USE.

Omron further disclaims all warranties and responsibility of any type for claims or expenses based on infringement by the Products or otherwise of any intellectual property right. (c) Buyer Remedy. Omron's sole obligation hereunder shall be, at Omron's election, to (i) replace (in the form originally shipped with Buyer responsible for labor charges for removal or replacement thereof) the non-complying Product, (ii) repair the non-complying Product, or (iii) repay or credit Buyer an amount equal to the purchase price of the non-complying Product; provided that in no event shall Omron be responsible for warranty, repair, indemnity or any other claims or expenses regarding the Products unless Omron's analysis confirms that the Products were properly handled, stored, installed and maintained and not subject to contamination, abuse, misuse or inappropriate modification. Return of any Products by Buyer must be approved in writing by Omron before shipment. Omron Companies shall not be liable for the suitability or unsuitability or the results from the use of Products in combination with any electrical or electronic components, circuits, system assemblies or any other materials or substances or environments. Any advice, recommendations or information given orally or in writing, are not to be construed as an amendment or addition to the above warranty.

See <http://www.omron.com/global/> or contact your Omron representative for published information.

Limitation on Liability; Etc.

OMRON COMPANIES SHALL NOT BE LIABLE FOR SPECIAL, INDIRECT, INCIDENTAL, OR CONSEQUENTIAL DAMAGES, LOSS OF PROFITS OR PRODUCTION OR COMMERCIAL LOSS IN ANY WAY CONNECTED WITH THE PRODUCTS, WHETHER SUCH CLAIM IS BASED IN CONTRACT, WARRANTY, NEGLIGENCE OR STRICT LIABILITY.

Further, in no event shall liability of Omron Companies exceed the individual price of the Product on which liability is asserted.

Suitability of Use.

Omron Companies shall not be responsible for conformity with any standards, codes or regulations which apply to the combination of the Product in the Buyer's application or use of the Product. At Buyer's request, Omron will provide applicable third party certification documents identifying ratings and limitations of use which apply to the Product. This information by itself is not sufficient for a complete determination of the suitability of the Product in combination with the end product, machine, system, or other application or use. Buyer shall be solely responsible for determining appropriateness of the particular Product with respect to Buyer's application, product or system. Buyer shall take application responsibility in all cases.

NEVER USE THE PRODUCT FOR AN APPLICATION INVOLVING SERIOUS RISK TO LIFE OR PROPERTY OR IN LARGE QUANTITIES WITHOUT ENSURING THAT THE SYSTEM AS A WHOLE HAS BEEN DESIGNED TO ADDRESS THE RISKS, AND THAT THE OMRON PRODUCT(S) IS PROPERLY RATED AND INSTALLED FOR THE INTENDED USE WITHIN THE OVERALL EQUIPMENT OR SYSTEM.

Programmable Products.

Omron Companies shall not be responsible for the user's programming of a programmable Product, or any consequence thereof.

Performance Data.

Data presented in Omron Company websites, catalogs and other materials is provided as a guide for the user in determining suitability and does not constitute a warranty. It may represent the result of Omron's test conditions, and the user must correlate it to actual application requirements. Actual performance is subject to the Omron's Warranty and Limitations of Liability.

Change in Specifications.

Product specifications and accessories may be changed at any time based on improvements and other reasons. It is our practice to change part numbers when published ratings or features are changed, or when significant construction changes are made. However, some specifications of the Product may be changed without any notice. When in doubt, special part numbers may be assigned to fix or establish key specifications for your application. Please consult with your Omron's representative at any time to confirm actual specifications of purchased Product.

Errors and Omissions.

Information presented by Omron Companies has been checked and is believed to be accurate; however, no responsibility is assumed for clerical, typographical or proofreading errors or omissions.

OMRON Corporation Industrial Automation Company

Kyoto, JAPAN

Contact: www.ia.omron.com

Regional Headquarters

OMRON EUROPE B.V.

Wegalaan 67-69, 2132 JD Hoofddorp
The Netherlands

Tel: (31)2356-81-300/Fax: (31)2356-81-388

OMRON SCIENTIFIC TECHNOLOGIES INC.

6550 Dumbarton Circle Fremont
CA 94555 U.S.A.

Tel: (1) 510-608-3400/Fax: (1) 510-744-1442

OMRON ASIA PACIFIC PTE. LTD.

No. 438A Alexandra Road # 05-05/08 (Lobby 2),
Alexandra Technopark,
Singapore 119967

Tel: (65) 6835-3011/Fax: (65) 6835-2711

OMRON (CHINA) CO., LTD.

Room 2211, Bank of China Tower,
200 Yin Cheng Zhong Road,
PuDong New Area, Shanghai, 200120, China

Tel: (86) 21-5037-2222/Fax: (86) 21-5037-2200

Authorized Distributor:

© OMRON Corporation 2018-2019 All Rights Reserved.
In the interest of product improvement,
specifications are subject to change without notice.

CSM_20_11_0719

Cat. No. A263-E1-05

0319(0917)