



Software For OMRON Uninterruptible Power Supply (UPS)

PowerAct Pro Master Agent

For Windows 7

Install Manual



OMRON

Precautions for Correct Use

Intended uses

This software is designed and produced for computers used in offices and server rooms. Never use this software for the following purposes, which require extremely high reliability and safety.

1. Use directly related to human life such as medical equipment
2. Use that could cause injuries
Example: Use directly related to the service, operation, or control of aircraft, ships, trains, or elevators.
3. Use for mission-critical computer systems, trunk line communication systems, or public transportation systems.
4. Use for any devices applicable to any of the above.

Software License Agreement

By installation of this software to your computer, you agree to be bound by the following Software License Agreement. If you do not agree, please do not install this software ("Software"). Please read the following terms and conditions carefully before using the software.

Software License Agreement

This is a binding agreement between OMRON SOCIAL SOLUTIONS CO.,LTD. ("OMRON") and you (the "User") on the terms and conditions of the license of the Software.

1. In this Agreement, "Software" means the computer program and related documentation contained in this package. The "Software" shall include any derivative works thereto. Copyright of the Software remains the sole property of OMRON or the third party who has licensed the Software to OMRON and shall not be assigned to the User under this Agreement.
In case the User infringes those rights, the User shall be liable to OMRON and/or such third party who has licensed to OMRON for any damage whatsoever arising from such infringement.
2. OMRON grants to the User a non-exclusive, non-transferable and limited license (i) to use the Software only for the purpose of monitoring and managing Uninterruptive Power Supply sold by OMRON to the User ("OMRON's UPS") on the computers those are owned by the User and are provided with power from such OMRON's UPS and (ii) to distribute the Software, either directly or through the User's normal distribution channels, to Customers, in object code form only as part of the User's Product which incorporates the OMRON's UPS and the Software, only for the purpose of monitoring and managing such OMRON's UPS on the computers those are owned by such Customer and are provided with power from such OMRON's UPS.
In this section 2, "User's Product" means the hardware or system software, both developed and marketed by the User in which the OMRON's UPS and the Software shall be incorporated, and "Customer(s)" means any end user of the User's Products which incorporates the OMRON's UPS and the Software.

3. Except as expressly permitted in Section 2 of this Agreement, the User shall not sub-license, assign nor lease the Software to any third party without prior written consent of OMRON.
4. The User may copy the Software for back-up purpose only. The User may not de-compile, reverse engineer nor otherwise attempt to discern the source code of the Software.
5. The User shall treat any information contained in the Software as confidential and shall not disclose it to any third party. This obligation shall survive the termination of this Agreement.
6. OMRON warrants to the User for a period of ninety (90) days after the User's purchase of the OMRON's UPS or the installation of the Software, whichever comes earlier, the Software will perform substantially in accordance with the user manual.

If the User discovers defect of the Software (substantial non-conformity with the manual), or physical defects (scratches, breaks or other similar damages) on software recording medium (limited to the case where such physical defects interfere with the ability of the User's computer to read the data of the Software) and return it to OMRON within the said ninety (90) days period, OMRON will replace the Software without charge. The User acknowledges that all errors or bugs of the Software may not be removed by such replacement. Notwithstanding the above, the warranty mentioned above shall not apply to any defect and physical defect of software recording medium resulting from the User's and/or third party's misuse, abuse or improper use of OMRON's UPS, the Software and/or the computer or failure to follow operating instructions, or use with equipment with which it is not intended to be used.
7. THE ABOVE REPLACEMENT SHALL CONSTITUTE THE USER'S SOLE AND EXCLUSIVE REMEDIES AGAINST OMRON AND THERE ARE NO OTHER WARRANTIES, EXPRESSED OR IMPLIED, INCLUDING BUT NOT LIMITED TO, WARRANTY OF MERCHANTABILITY OR FITNESS FOR PARTICULAR PURPOSE.

IN NO EVENT, OMRON WILL BE LIABLE FOR ANY LOST PROFITS OR OTHER INDIRECT, INCIDENTAL, SPECIAL OR CONSEQUENTIAL DAMAGES ARISING OUT OF THIS AGREEMENT OR USE OF THE SOFTWARE.
8. In any event, OMRON's entire liability to the User for any cause shall not exceed the amount actually paid by the User to purchase the OMRON's UPS which is monitored and managed by the Software.
9. If the User breaches this Agreement, OMRON may terminate this Agreement upon notice to the User. In that event, the User shall return the Software and all copies thereof.
10. Neither this Agreement nor any party or portion hereof shall be assigned, sub-licensed or otherwise transferred by the User. Should any provision of this Agreement be held to be void, invalid, unenforceable or illegal by a court, the validity and enforceability of the other provisions of this Agreement shall not be affected thereby. Failure of a party to enforce any provision of this Agreement shall not constitute or be construed as a waiver of such provision or of the right to enforce such provision.
11. If the User will modify, de-compile, reserve engineer, or otherwise attempt to discern the source code of the Software, OMRON shall have no liability for any claim of patent, utility model right, trade secret or copyright infringement whenever the User was claimed by the third party who consented OMRON to use the Software or by the other third party.

12. This Agreement shall be governed by and construed under the laws of Japan.

13. If the User is a person living in Japan or a corporation organized and existing under the laws of Japan, any dispute, controversy or difference which may arise between the parties hereto arising out of or in relation to or in connection with this Agreement shall be solely resolved through a legal proceedings before the District Court of Tokyo, which shall have the exclusive jurisdiction over the dispute.

In other cases, any and all dispute, controversy or difference which may arise between the parties hereto out of or in relation to or in connection with this Agreement shall be finally settled by arbitration in Tokyo in accordance with the Arbitration Rules of the Japan Commercial Arbitration Association. The award rendered by arbitrator(s) shall be final binding upon the parties hereto.

14. This English version of this Agreement is prepared for reference purpose only. In the event of any conflict or inconsistency between the Japanese version and this English version, the Japanese version shall prevail.

Requests regarding operation

1. Any diversion of all or part of the contents of the software and this manual without permission is strictly prohibited.
2. The contents of this software and the document may change in the future, without notice.
3. We have made every effort to make the contents of this software and the document complete, however, if you notice an error or other points by any chance, please let us know.
4. Some screens and other graphic items in this document may differ from the actual ones.
 - Google Chrome is a trademark of Google.
 - Linux is a registered trademark of Linus Torvalds in the United States and other countries.
 - Microsoft, Internet Explorer, and Windows are registered trademarks of United States Microsoft Corporation in the United States and other countries.
 - Mozilla and Firefox are registered trademarks of Mozilla Foundation.
 - Other company names and product names mentioned in this manual are the trademarks or registered trademarks belong to their respective owners.

© OMRON SOCIAL SOLUTIONS CO.,LTD. 2016-2019 All Rights Reserved.

How to Use this Manual



What's in this Manual

This manual consists of the following.

Introduction	Describes the features of the software and the entire system configuration.
Installation	Describes the required conditions for installing the software and three installation methods: installation using Apache, installation using IIS, and installation not using Web server software.
Shutdown Operation Check	Describes the operation settings when the software shuts down. Also describes how to conduct a shutdown test.
Troubleshooting	Describes how to change the number of the HTTP port used by the software. Also describes how to manually set the communication port.
Appendix	Describes the operation sequences of the software. Also describes how to automatically start up the server when power is restored and how to remove the software.

Notes on signs, terminology, and use of quotation marks

The signs, terminology, and quotation marks below are used in the manual.

	Indicates a point the user is requested to observe or an item requiring attention during operation is described. Carefully read the description and be sure to do as instructed.
	Indicates that useful information or information giving some hint is described. Also indicates that pages where related information is described or other manuals are described.
The software	Refers to OMRON PowerAct Pro Master Agent.
[]	Among the items displayed on screen, the items to be operated (buttons to be clicked, etc.) are written with square brackets ("[]"). Example: Click the [Next] button.
" "	Quotation marks (" ") are used to indicate items displayed on screen other than the above and link destinations. Example: If no result is displayed for "Communication Port Test Result", communication between the software and the UPS is not established.

Contents

Precautions for Correct Use	1
How to Use this Manual	4
Contents	5
1 Introduction.....	7
1-1 Functions and features	7
1-2 Connecting equipment and operation	8
1-2-1 Connecting one computer	8
1-2-2 Connecting more than one computer	8
1-2-3 Example of a system configuration on virtual OS	10
1-3 Types of installation	11
1-4 Installation procedure and operation check	13
2 Installation Preparations	14
2-1 Notes on installation	14
2-2 Operation environment.....	15
3 Installation Method - Using Apache 2 -	16
3-1 Installing the software.....	16
3-2 Setting Pop-up Blocker.....	33
3-3 Installing the server certificate.....	38
4 Installation Method - Using IIS -	46
4-1 Enabling and setting IIS	46
4-2 Installing the software.....	49
4-3 Setting Pop-up Blocker.....	61
4-4 Installing the server certificate.....	66
5 Installation Method - Not Using Web Server Software -	74
5-1 Installing the software.....	74
6 Shutdown Operation Check.....	86
6-1 Setting shutdown parameters - Using Web server software -	86
6-2 Setting shutdown parameters - Not using Web server software -	92
6-3 Shutdown test.....	97

7 Troubleshooting.....	100
7-1 When the "Check http port" warning appears	100
7-1-1 Changing the port number while installing the software	100
7-1-2 Changing the HTTP port number after installing the software	102
7-2 Unable to communicate with the UPS.....	109
7-2-1 For connection via USB	110
7-2-2 Using Web server software	111
7-2-3 If not using Web server software (setting the communication port in "Auto" mode).....	114
7-2-4 If not using Web server software (setting the communication port in "Manual" mode).....	119
7-2-5 Selecting "Manual" in "Communication Port Setting"	126
Appendix	128
Appendix-1 Shutdown operation sequence.....	128
Appendix-1-1 Operation sequence with the initial settings.....	128
Appendix-1-2 Operation sequence with values set for items other than the basic items (such as Shutdown Start Delay Time).....	129
Appendix-1-3 When power is restored before the UPS stops outputting power	130
Appendix-2 Automatically starting the sever after power recovery	131
Appendix-2-1 Setting the UPS and computer to automatically start up	131
Appendix-2-2 When power is restored before the UPS stops, if the computer does not automatically start up	133
Appendix-3 How to remove the software	138

1 Introduction

1-1 Functions and features

An Uninterruptible Power Supply (hereafter called as "UPS") is a device for protecting equipment connected to it from power supply abnormalities such as a power failure. However, due to its internal battery capacity, UPS can supply power to the system only for a limited period of time.

For that reason, automatic shutdown software is used to make the system end normally within a certain period of time so as to prevent trouble such as a hard disk drive failure and damage on the system file.

PowerAct Pro is a power management solution with functions also supporting redundant power supply and outlet control built-in.

PowerAct Pro has the following features.

Schedule Action	Lets you specify the condition such as time and date, weekly, and monthly to stop or start the UPS, or conduct a self test on the UPS.
Linked shutdown	Lets you shut down multiple servers or clients on the network by linking them together.
Outlet control	Lets you delay the start of output from an outlet when the UPS starts up or the stop of output from an outlet when the UPS shuts down, by combining the UPS having outlet control functionality with the software.
Application file auto saving	When an input power supply abnormality (power failure, etc.) occurs, automatically saves the files currently created and edited, and ends the application software or the OS.
Multi-OS support	Supports four operating systems, Windows, Linux, Macintosh, and Unix.
GUI	Lets you configure settings on graphical screens.
Virtual server support	Supports Hyper-V/VMware and can control multiple Guest Operation Systems. Not required to be installed to Guest OS.
Script Shutdown	Lets you shut down the OS of such equipment as an appliance server, to which software cannot be installed, using a script.
Ping monitoring and mobile terminal monitoring	Lets you perform the monitoring of the operating states of terminals on the network or outlet control (reboot) from a mobile terminal, without using SNMP.
SNMPv3 support	Supports SNMPv3, and lets you manage power supplies on the network in a secure environment.
CO2 monitoring function	Lets you measure the amount of CO2 easily based on the power consumption of connected terminals. When this function is used together with the Schedule Action function, CO2 emissions or electricity charges can be reduced by stopping the equipment operation during the night and on holidays.

1-2 Connecting equipment and operation

PowerAct Pro consists of "Master Agent" (this software), used for the computer directly connected to the UPS via exclusive cable (RS232C or USB), and "Slave Agent", used for a computer connected via network.

Linked with this software, Slave Agent shuts down its local computer.

1-2-1 Connecting one computer

Connect the computer to the UPS with an included exclusive cable (RS232C or USB) and install the software.

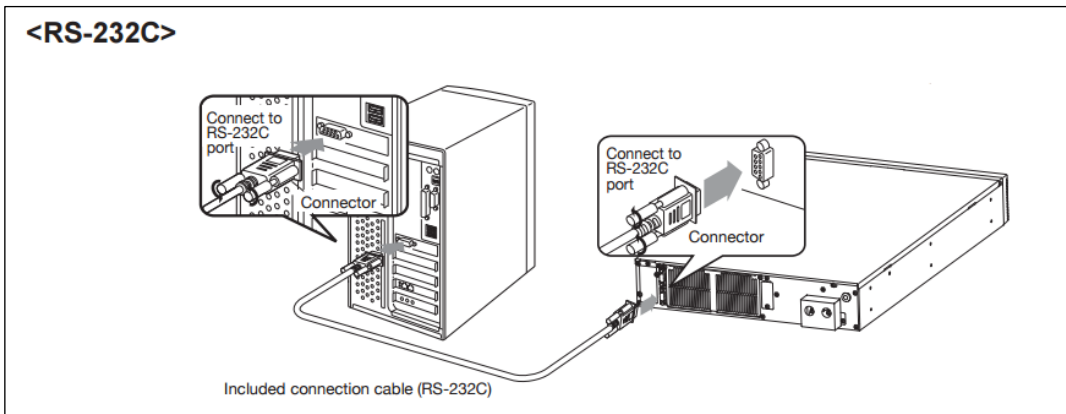

1-2-2 Connecting more than one computer

- A computer directly connected to the UPS with an exclusive cable

Install the software to the computer directly connected to the UPS with an exclusive cable (RS232C or USB).

- Other computers

There are two ways to perform operation.

Method ① Install "PowerAct Pro Slave Agent".

Method ② Automatically shut down a computer by issuing a script command from the software.

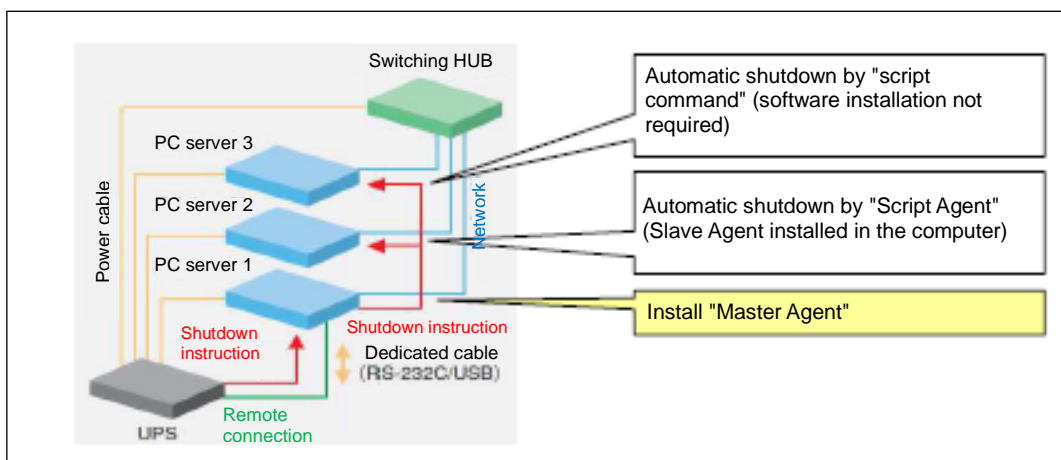

Image of operation in the case of multiple computers

Hint

- For details on how to install Slave Agent, see the attached installation guide.
- Use either RS232C or USB to connect a computer to the UPS. Also, connect each computer to the network on the same segment. If not all computers can connect to the network on the same segment, increase the number of LAN ports by adding a network interface card to the Master Agent computer, for example, so that all computers can be set to belong to the same segment.

Example:

■ Master Agent

- Installed in a server computer directly connected to the UPS via RS232C or USB.
- Centrally manages the monitoring and control of the UPS, and the start and stop of the server computers connected via LAN.
- "SC20G/SC20G2", which is used by being implemented in the UPS, functions as Master Agent because it also controls the UPS directly.

■ Slave Agent

- Shuts down its local server computer based on an instruction from Master Agent.
- Does not control the UPS.

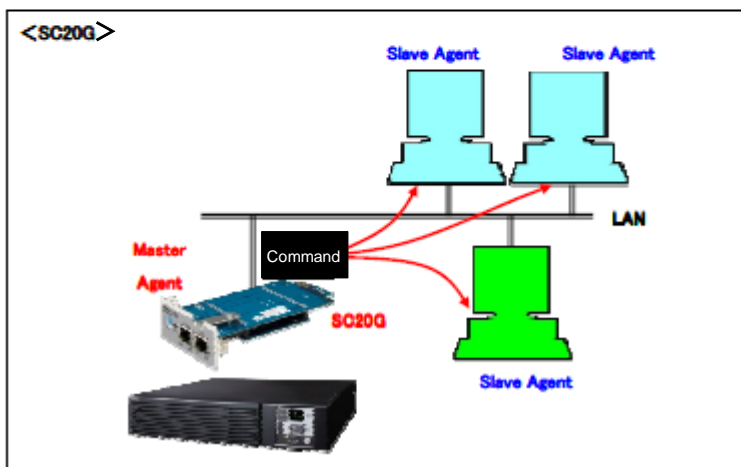
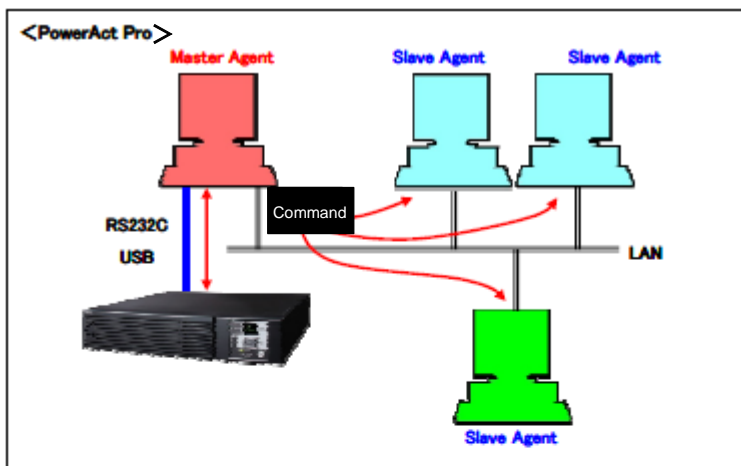

1-2-3 Example of a system configuration on virtual OS

For use in a virtual environment using Hyper-V, install PowerAct Pro on the host side.

PowerAct Pro is not required to be installed on the Guest OS side. Each Guest Operation System is automatically shut down. When the system reboots, each Guest Operation System starts up in the state before shutdown.

- Both Master Agent and Slave Agent can be installed.
- To install Master Agent, connect via RS232C or USB.
- To install Slave Agent, Master Agent is required.

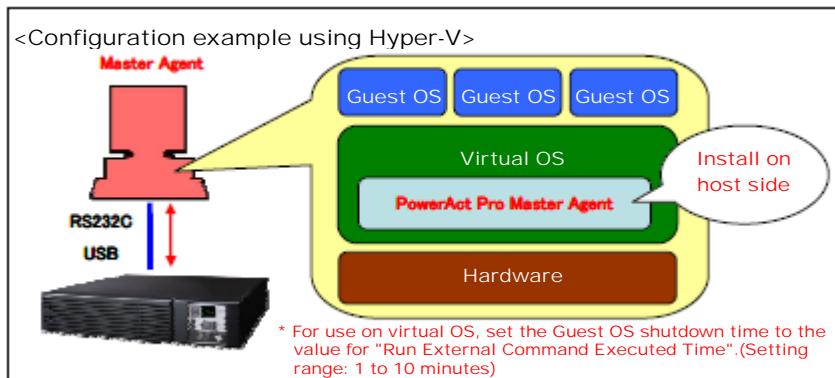

1-3 Types of installation

In this software, settings are made on the Web-based monitor window.

To display this Web Monitor window, Web server software is installed.

For Web server software, Apache or IIS (Internet Information Services) is used.

There is also a way to perform control from the console without using the Web Monitor window.

Therefore, when installing the software, make a choice among the following three methods.

Using Apache	See p.16.
Using IIS	See p.46.
Not using Web server software	See p.74.

CAUTION

For this software, Apache is recommended as Web server software. If Apache is already used for existing software, use IIS.

Hint

If not using Web server software, the PowerAct Pro Monitor window cannot be displayed; only the basic shutdown parameters (see p.92, "6-2 Setting shutdown parameters - Not using Web server software -".) can be set.

Other items are set using the console mode. For details on how to operate the console mode, see the separate document "Console Mode Setting Guide".

Monitor window

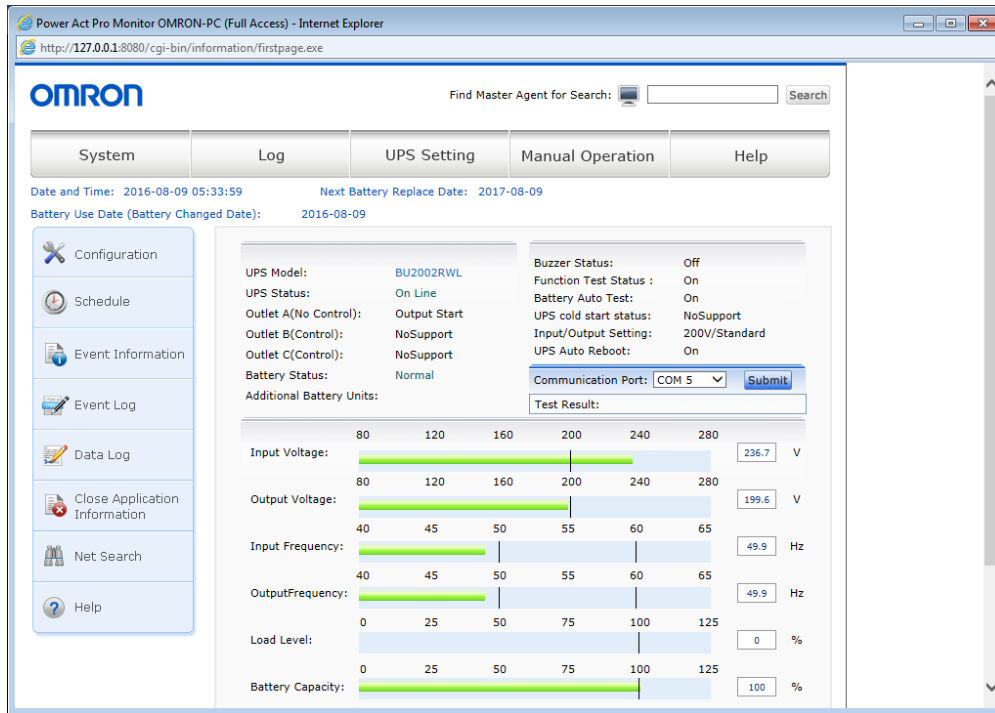

Console mode setting window

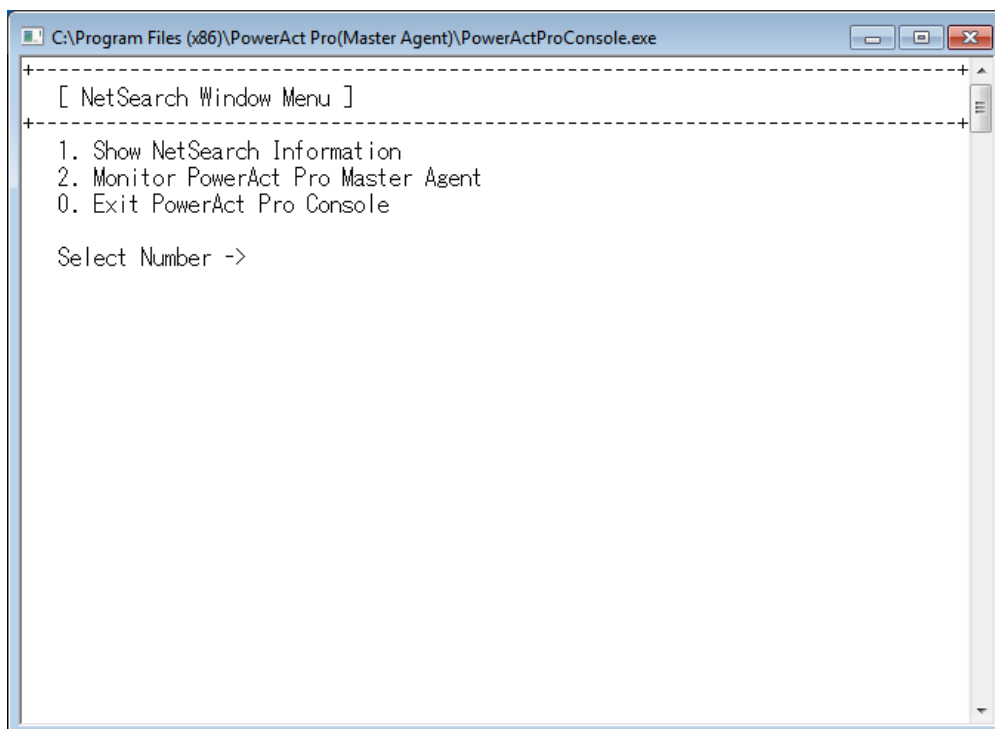

1-4 Installation procedure and operation check

Install the software using the following procedure and check the operation.

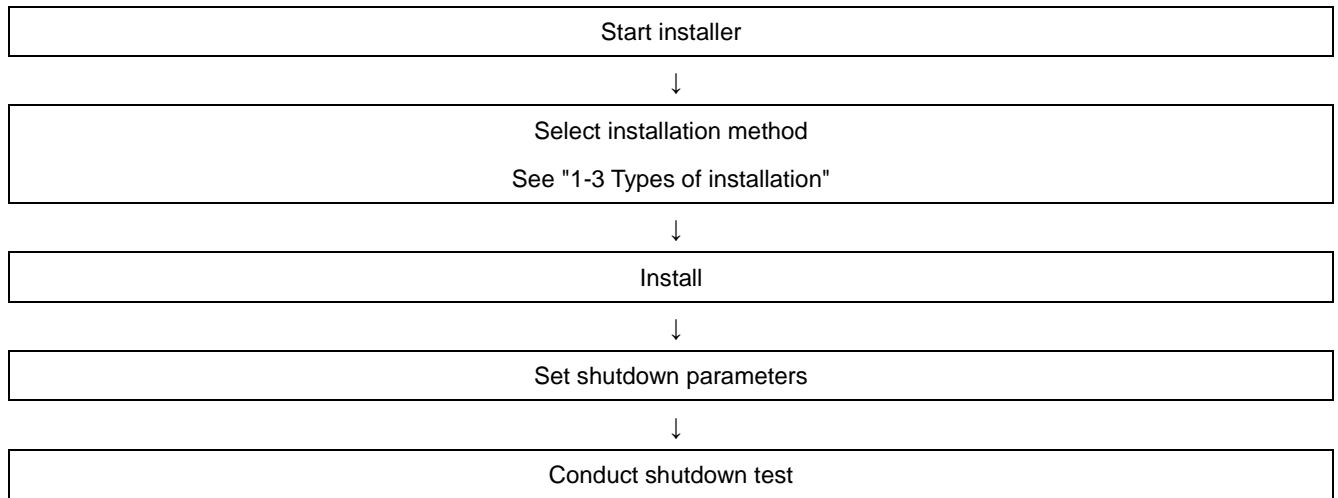

2 Installation Preparations

2-1 Notes on installation

Before installing the software, check the following.

<Product>

- This software can be used only on Omron's UPS and OEM-supplied Omron UPS.

<Environment>

- Log in to the OS with a username with administrator authority.
- Check that the OS can end normally in your usage environment.
- When using other automatic shutdown software, make sure to uninstall that software first, and restart the OS. For details on how to uninstall each software application, see its instruction manual.
- Connect your computer to the UPS before installing the software.

2-2 Operation environment

Web browser	Microsoft Internet Explorer 11.0/10.0
HTTP server	Apache HTTP Server Internet Information Services (Windows OS standard)
RAM	256MB or more
Hard disk capacity	100MB or more
Interface	RS232C, USB
Network card	10Mbps or over
Protocol	TCP/IP

3 Installation Method - Using Apache 2 -

3-1 Installing the software

- 1 Please download the PowerAct Pro software from OMRON's Web site.

File name: PAPV***_Master_Windows.zip (Remark: *** is Number from 0 to 9 <Ex:515>)

- 2 Unzip the download file "PAPV***_Master_Winodws.zip".

Hint

If start unzip operation for "PAPV***_Master_Windows.zip", the "PAPV***_Master_Windows" folder create automatically.

- 3 Open the "PAPV515_Master_Windows" folder and then double click "Setup.exe".

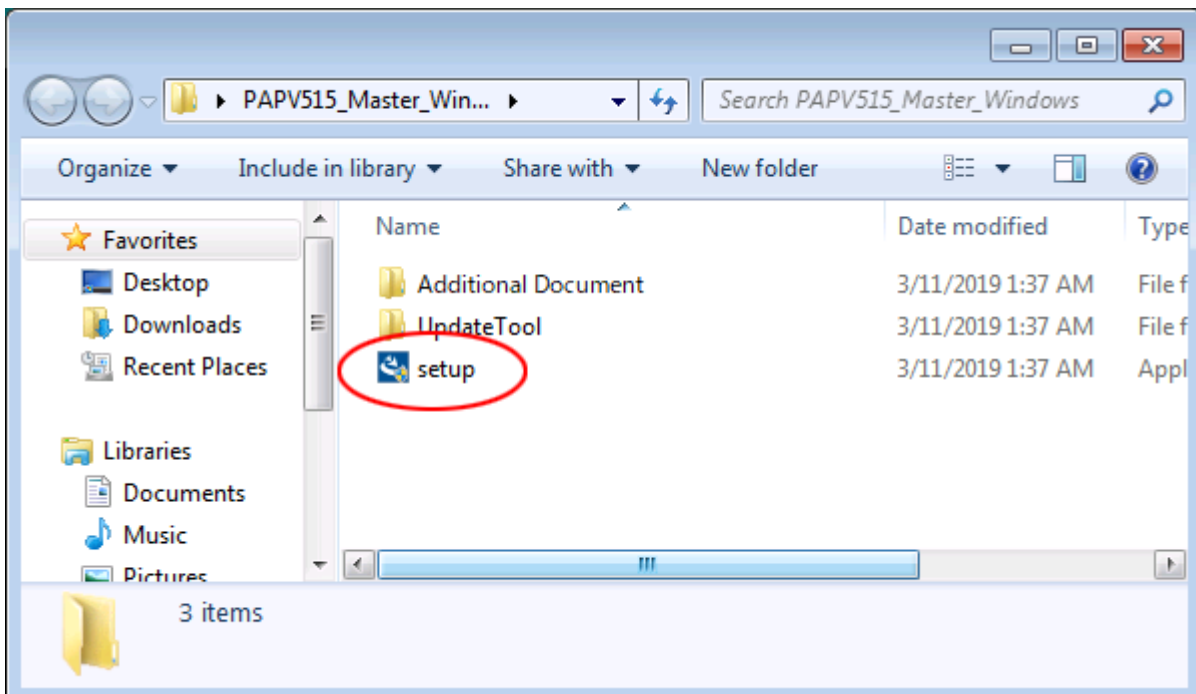

- 4 Click the [Yes] button.

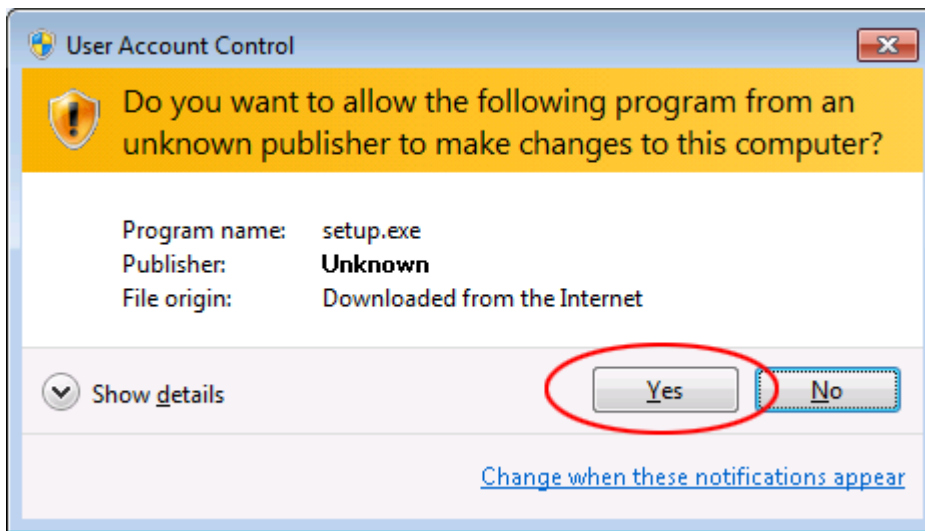

- 5 Click the [Next >] button.

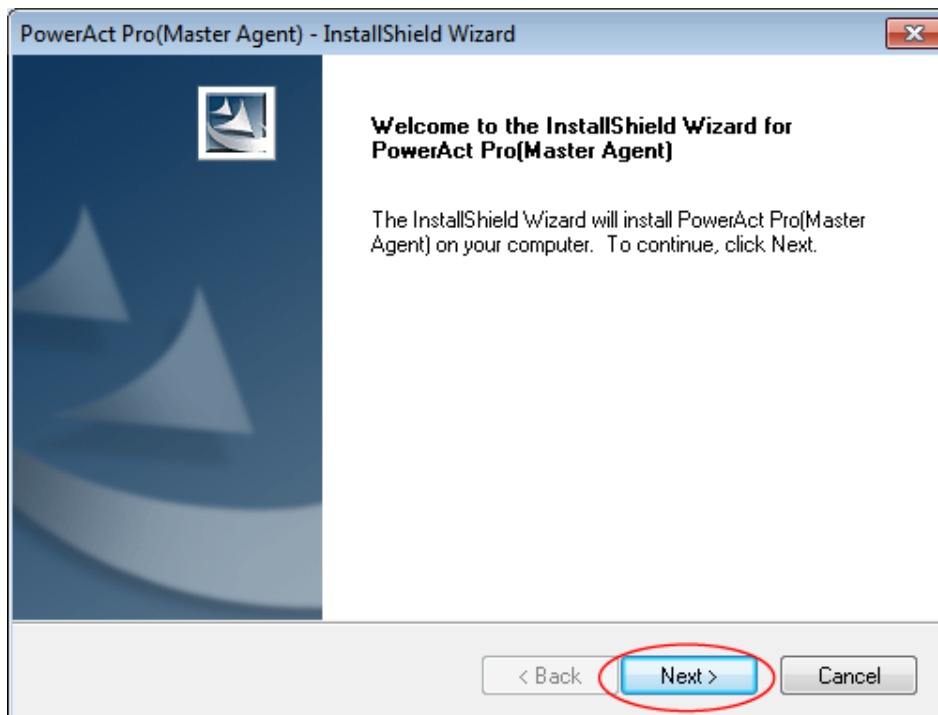

- 6 Read the contents of "License Agreement" carefully, select the radio button for "I accept the terms of the license agreement", and click the [Next >] button.

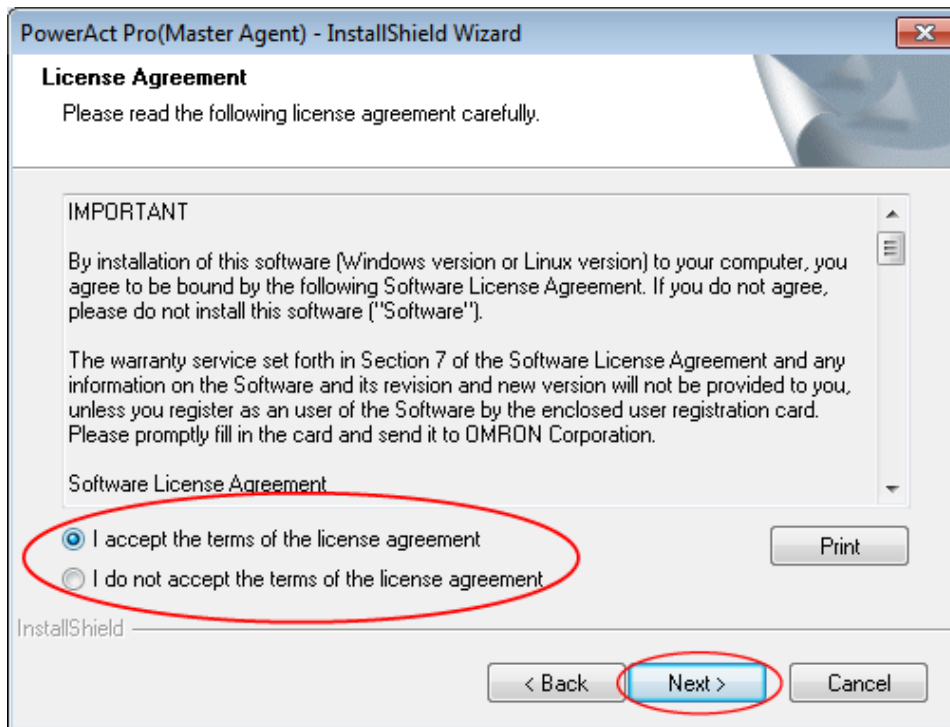

Hint

If you do not accept the terms of the license agreement, you can not use the software.
In that case, click the [Cancel] button to stop the installation process.

- 7 Select the radio button for "Standard Install [Enable network function]", and click the [Next >] button.

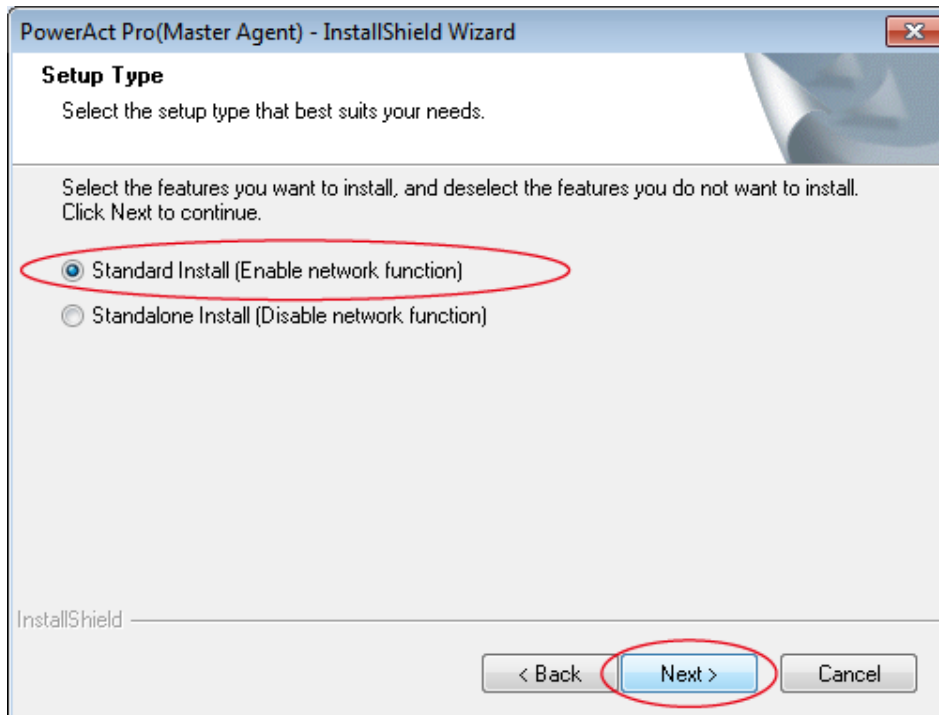

Hint

When "Standard Install" is selected, you can use the following via the network.

- Checking, setting, and controlling UPS information in the Web Monitor window of a computer on the network
- Shutting down a computer where Slave Agent is installed
- Shutdown warning using SNMP and notification of UPS operation information to specified computers

- 8 Select the radio button for "Use Apache Web Server" and click the [Next >] button.

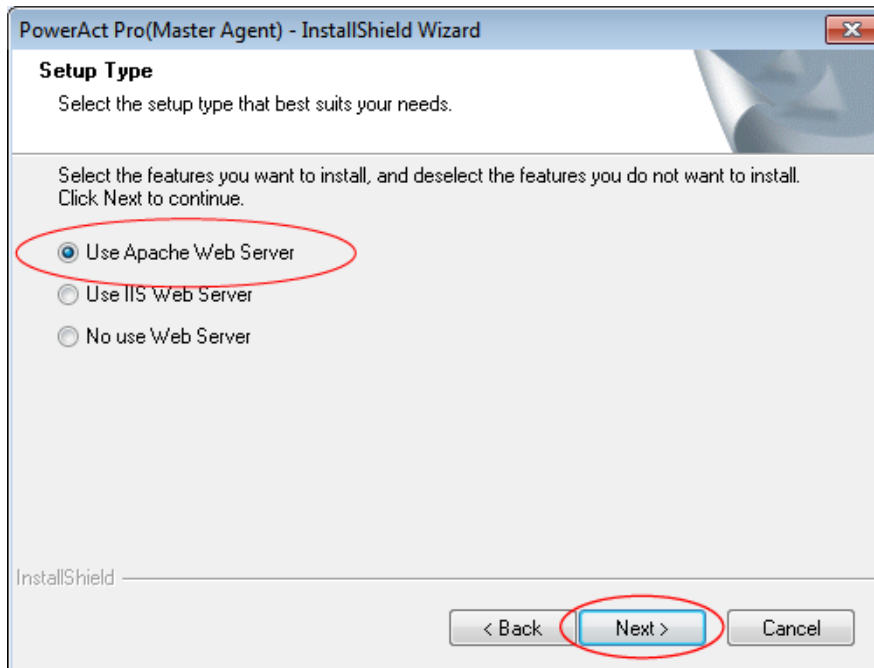
**CAUTION**

For this software, Apache is recommended as Web server software. If Apache is already used for existing software, use IIS.

Hint

If not using Web server software, the PowerAct Pro Monitor window cannot be displayed; only the basic shutdown parameters (see p.92, "6-2 Setting shutdown parameters - Not using Web server software -".) can be set. Other items are set using the console mode. For details on how to operate the console mode, see the separate document "Console Mode Setting Guide".

- 9 Click the [OK] button.

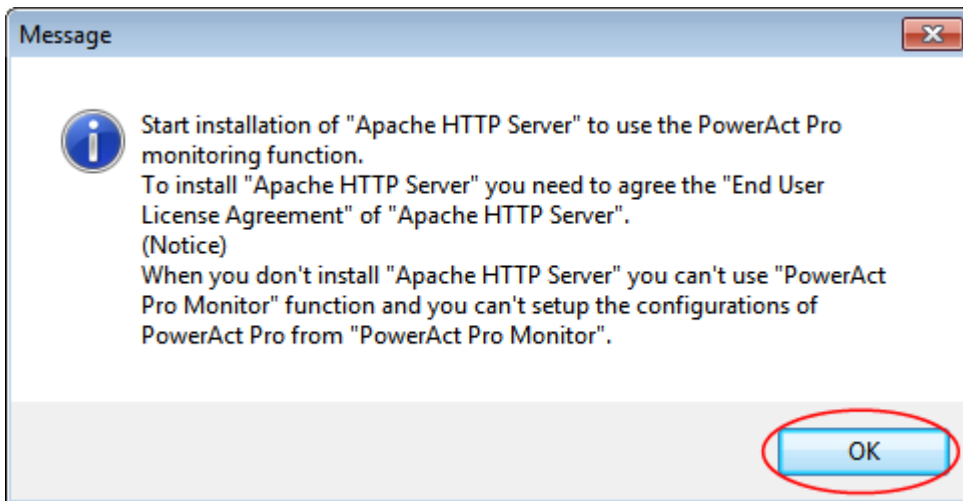

Hint

When the following window may appear, click the [Install] button.

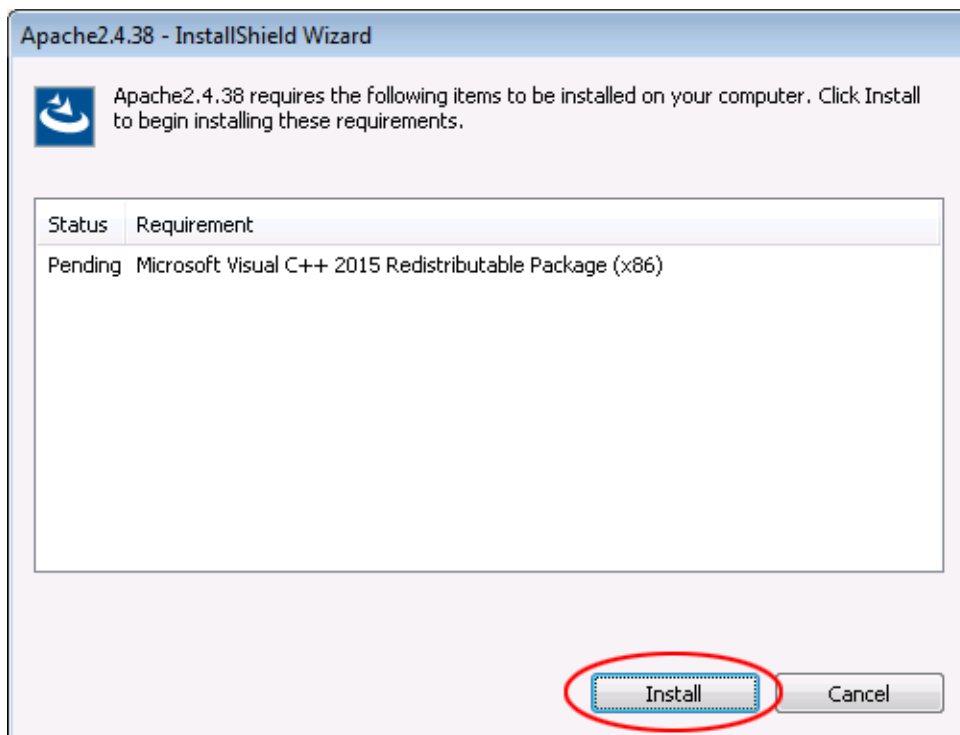

10 Click the [Next >] button.

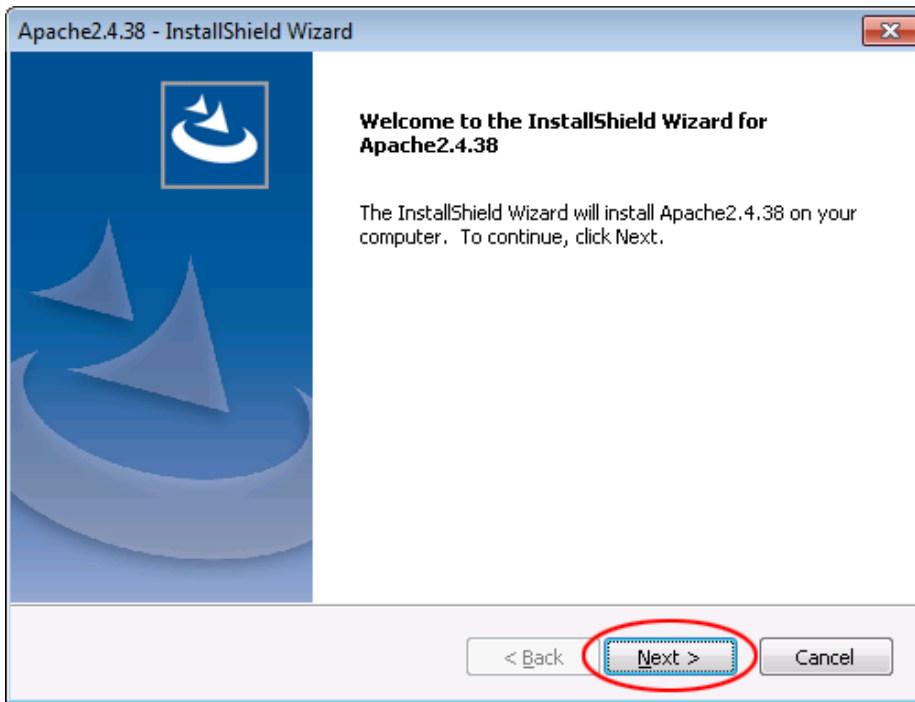

11 Read the contents of "License Agreement" carefully, select the radio button for "I accept the terms of the license agreement", and click the [Next >] button.

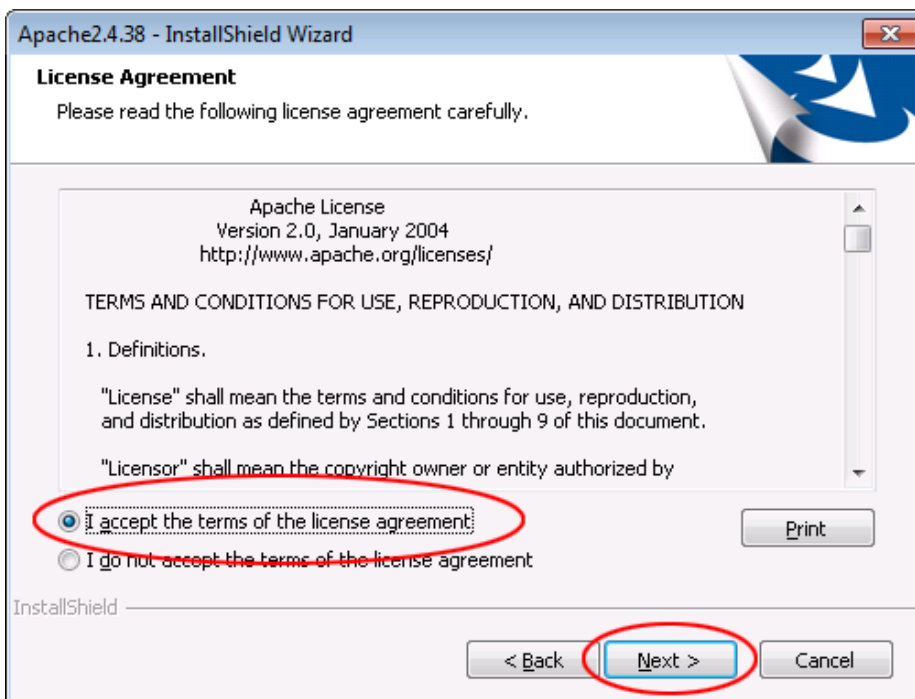

Hint

If you do not accept the terms of the license agreement, you can not use the software.

If you select the radio button for "I do not accept the terms of the license agreement", click the [Cancel] button to stop the installation process.

12 Click the [Next >] button.

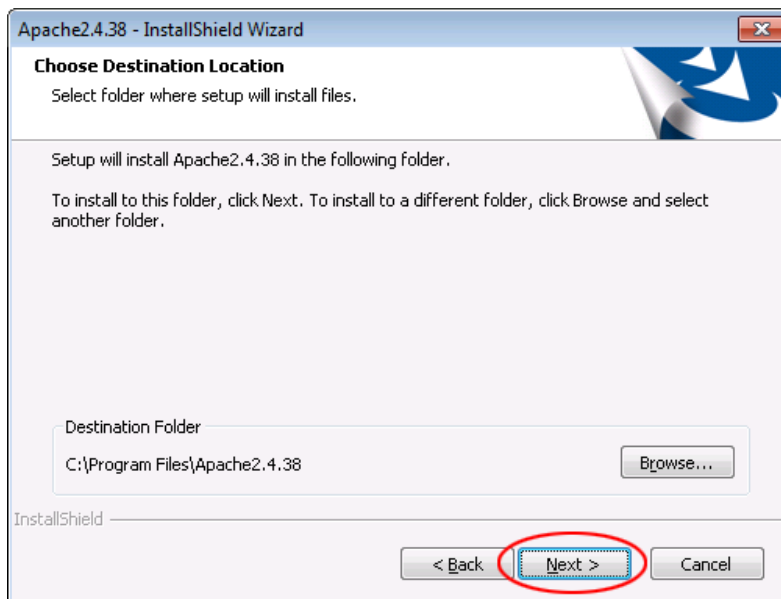
**CAUTION**

Do not install Apache in a write-protected folder or network drive.

Be sure to install it in the read and write permitted hard disk drive in the local computer.

Hint

In this window, you can change the installation destination location for Apache. To change the installation destination location for Apache, click the [Browse...] button, specify the installation destination location, and click the [Next >] button.

13 Click the [Install] button.

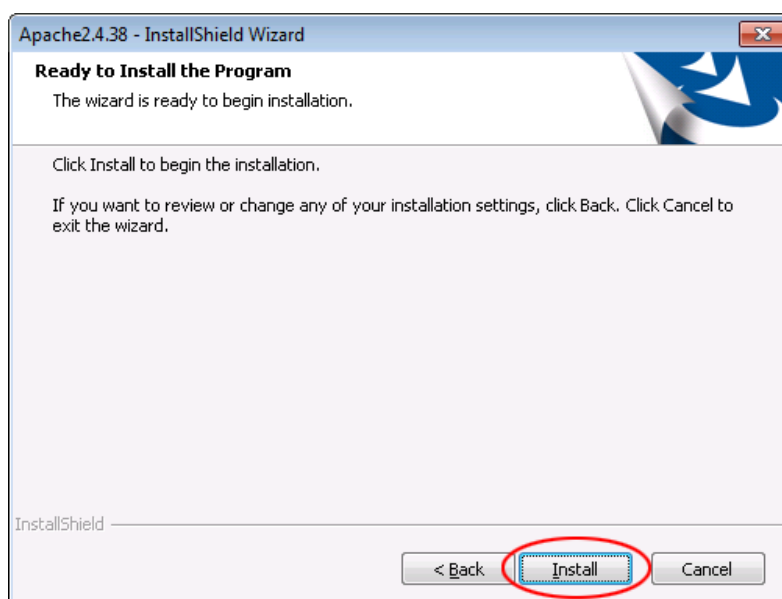

14 Click the [Finish] button.

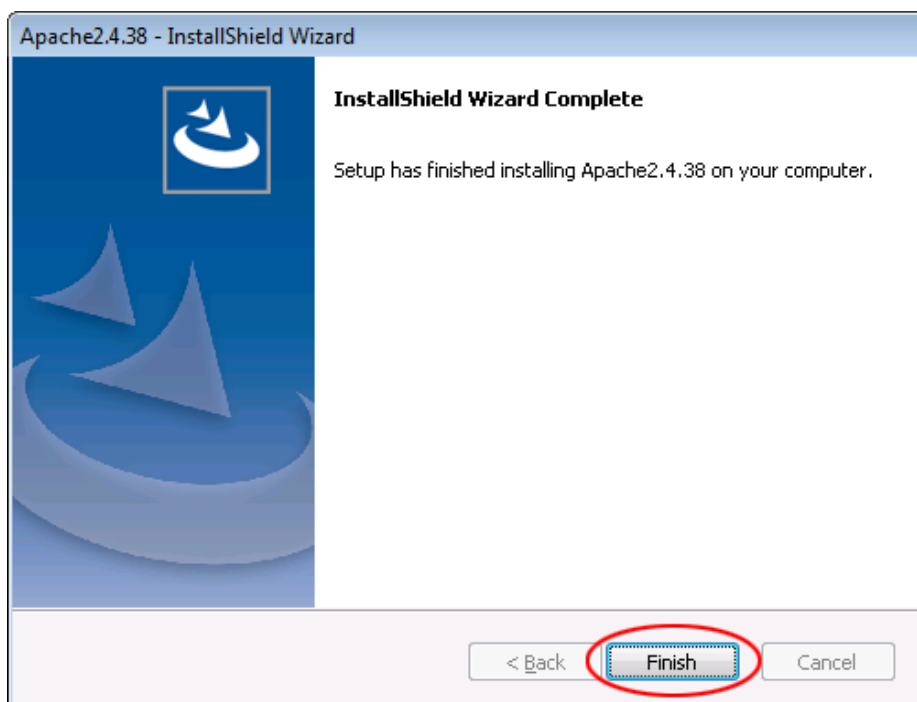
**CAUTION**

When the [Finish] button is clicked, the following window is displayed for a moment. Wait until the next window appears.

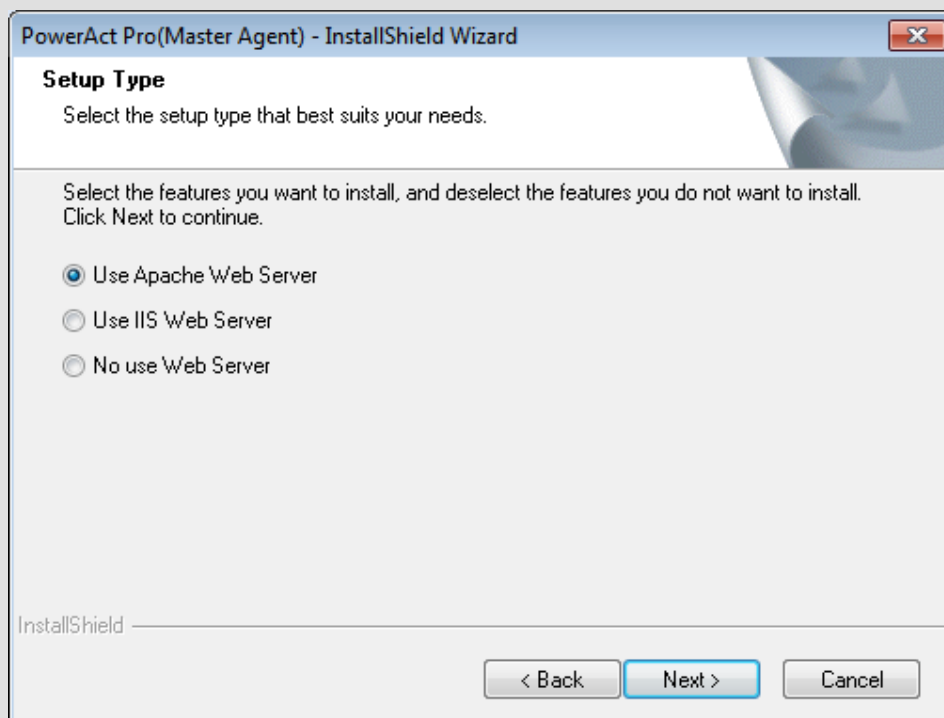

15 Click the [Next >] button.

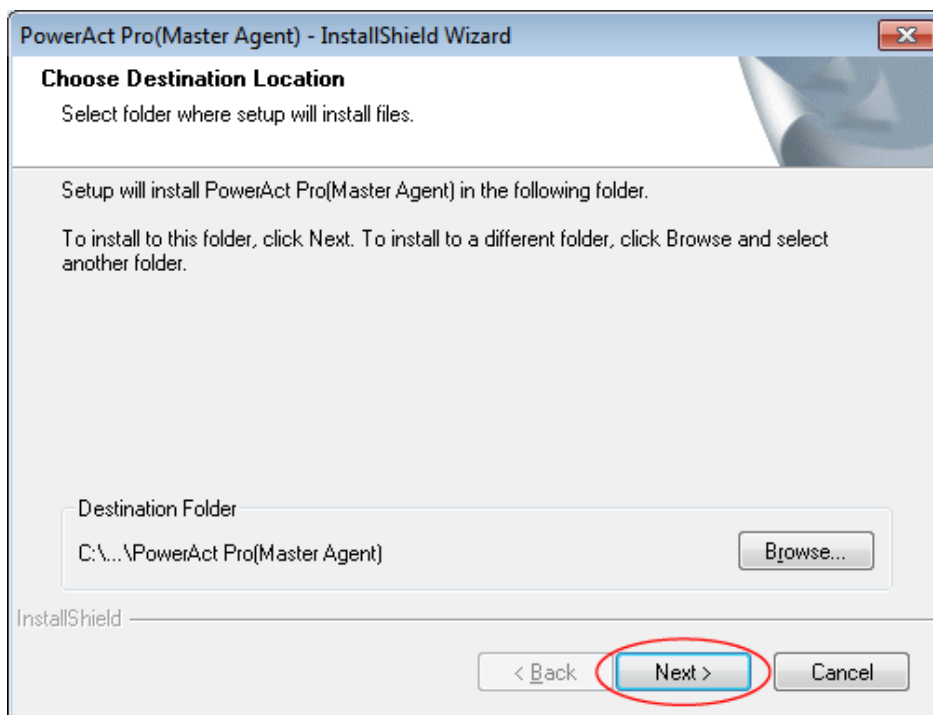
**CAUTION**

Do not install the software in a write-protected folder or network drive.
Be sure to install it in the read and write permitted hard disk drive in the local computer.

Hint

In this window, you can change the installation destination location for the software. To change the installation destination location for the software, click the [Browse...] button, specify the installation destination location, and click the [Next >] button.

16 Click the [Next >] button.

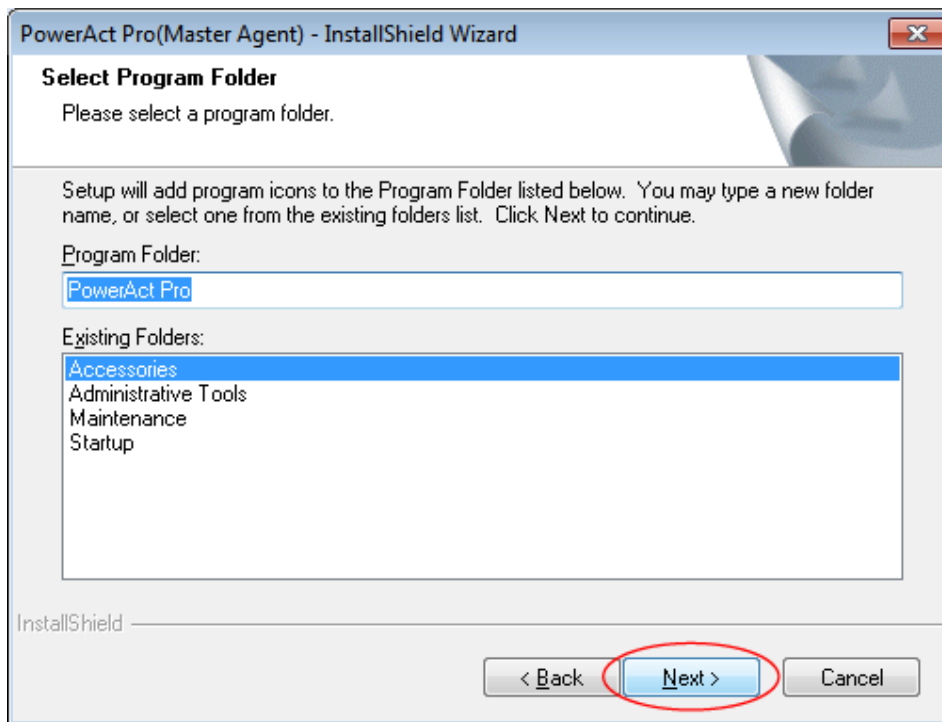

17 Click the [Next >] button.

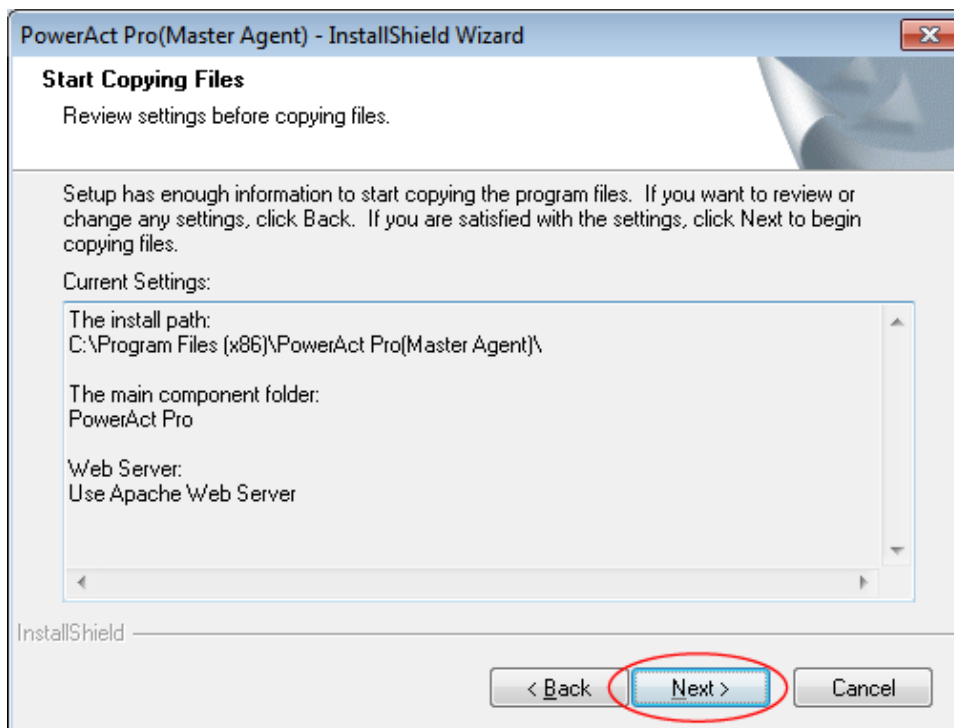

18 Click the [No] button.

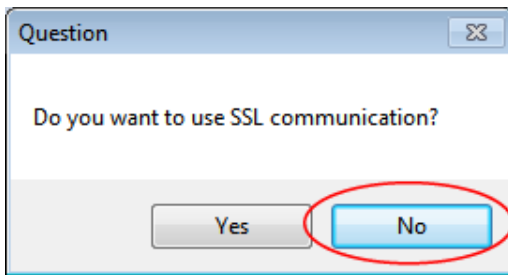

Hint

To use encrypted communication, select [Yes]. When the Certificate at PowerAct Pro window appears, click the [OK] button.

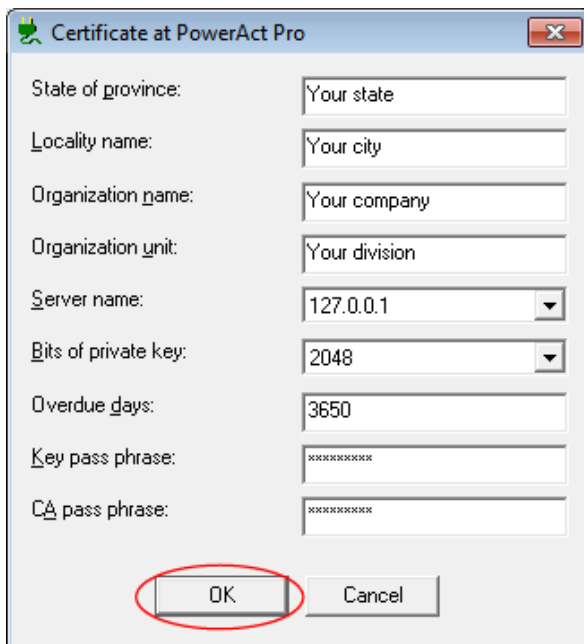

When PowerAct Pro has been installed completely, install "Server Certificate" (see p.38, "3-3 Installing the server certificate").

19 Select either "Auto" or "Manual", and click the [OK] button.

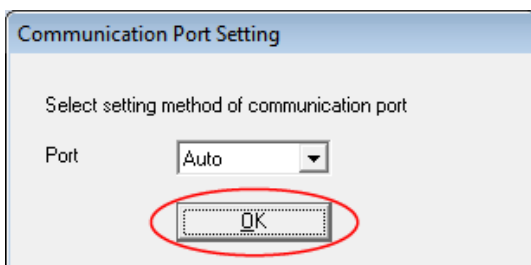

Hint

When "Auto" is selected, the COM ports, and then USB ports are searched to find the connected UPS.

When "Manual" is selected, only the set COM port is searched (see p.126, "7-25 Selecting "Manual" in "Communication Port Setting").

20 Check the result, and click the [OK] button.

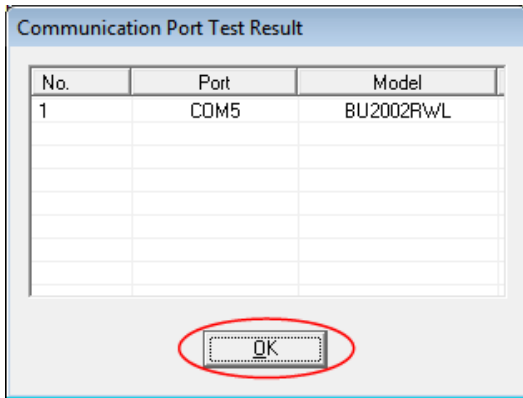

Hint

If no result is displayed for "Communication Port Test Result", communication between the software and the UPS is not established. However, there is no problem with the installation process itself, so click the [OK] button, and proceed to step 23. If you want your computer to communicate with the UPS at this point, see p.109, "7-2 Unable to communicate with the UPS".

Hint

If no result is displayed for "Communication Port Test Result" in step 21, neither the window in step 22 nor the window in step 23 is displayed.

21 Enter values for "UPS Start Date:", "Battery Use Date (Battery Change Date):", and "Next Battery Replace Date:", and click the [OK] button.

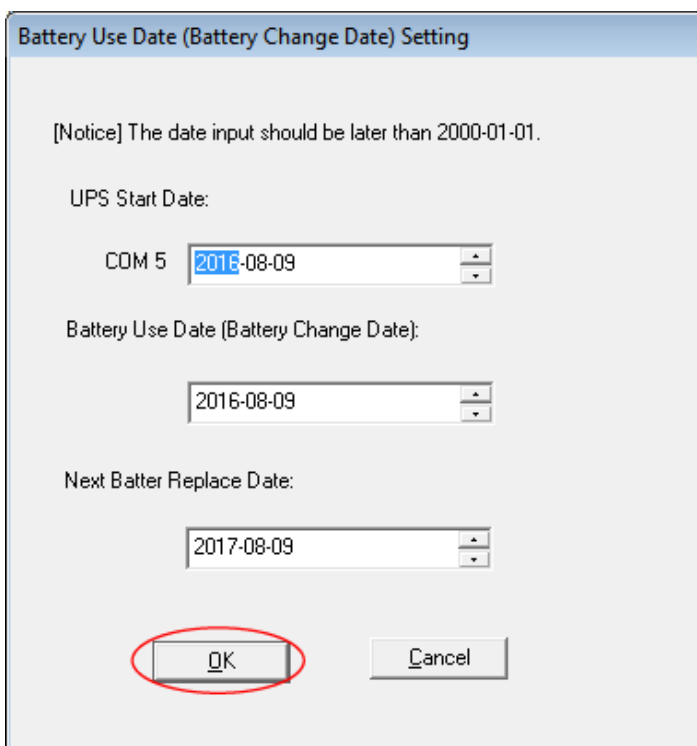

22 Click the [OK] button.

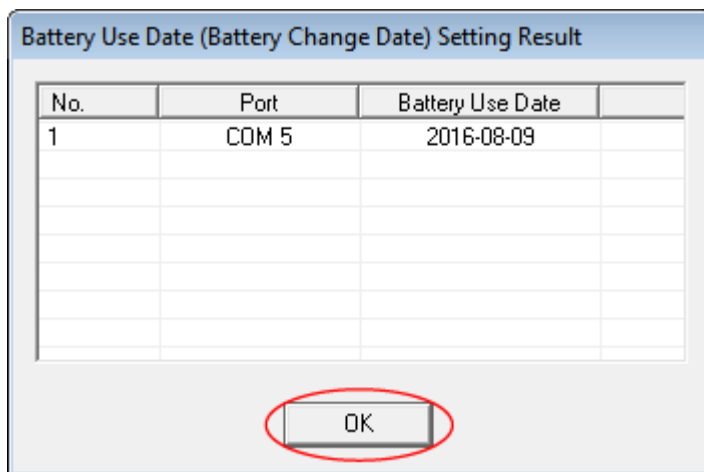
**CAUTION**

A warning window may appear after setting a battery use date. In that case, select the [Communication] tab and change the HTTP port number (see p.100, "7-1 When the "Check http port" warning appears").

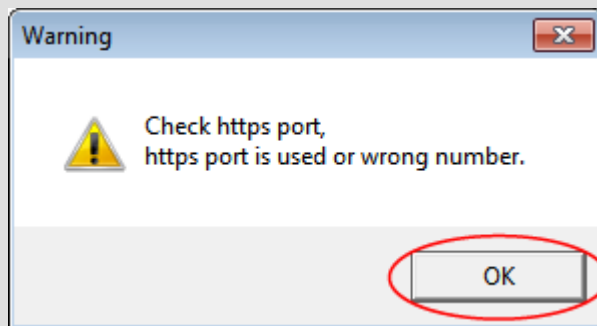

23 Click the [OK] button.

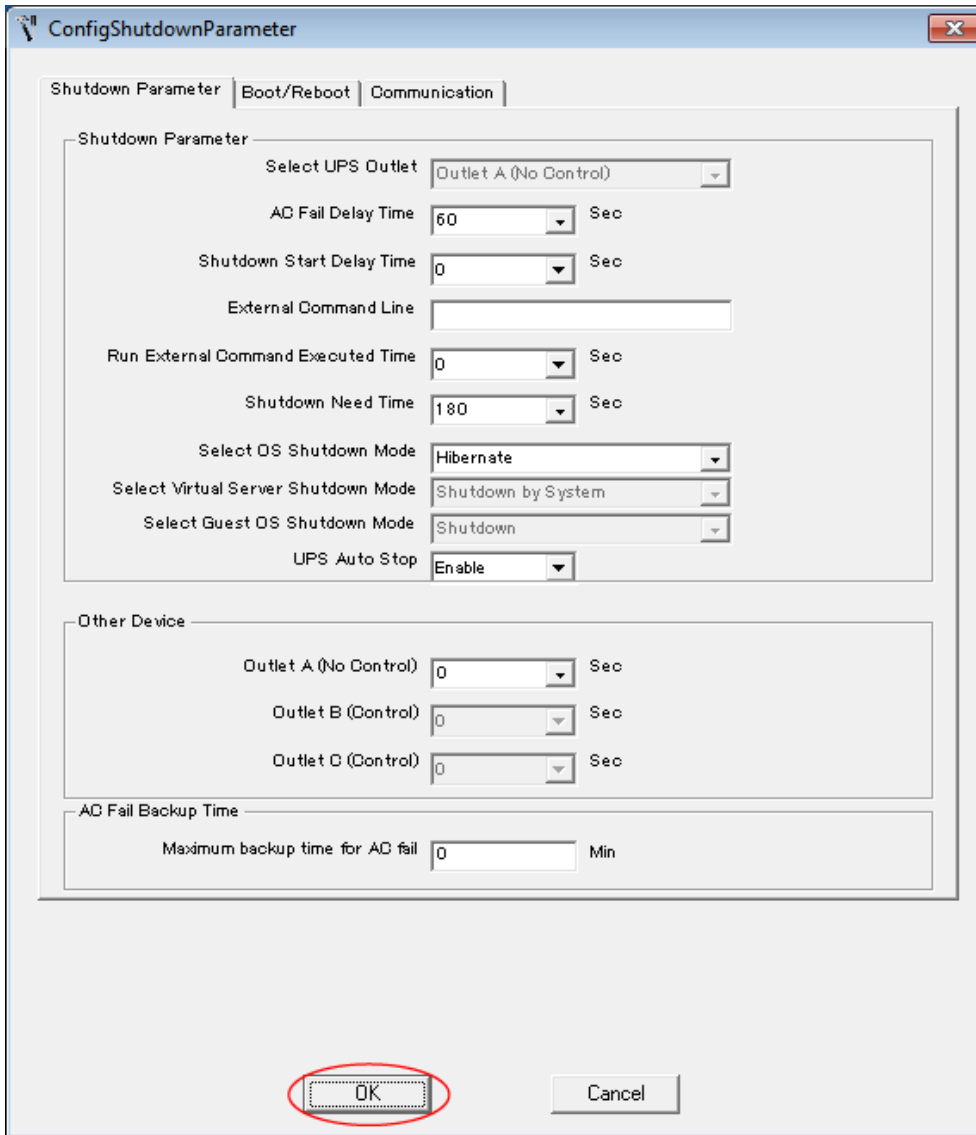

Hint

After the installation process is completed, you can also set the shutdown operation in "Configuration" of [PowerAct Pro Monitor] (see p.86, "6-1 Setting shutdown parameters - Using Web server software -").

24 Click the [Yes] button.

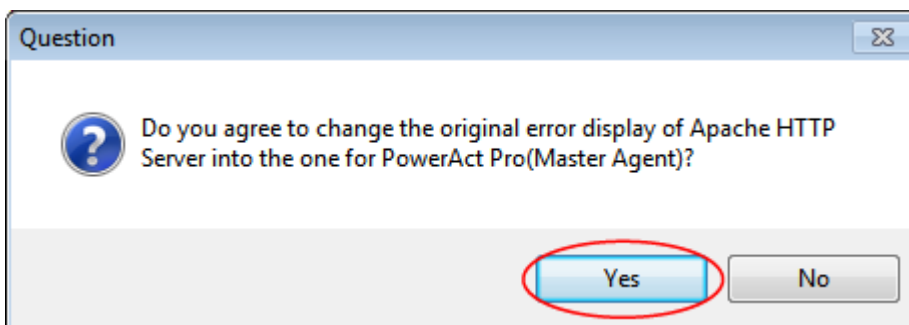

25 Specify the password in 1 to 15 single-byte alphanumeric characters (A to Z, a to z, 0 to 9).

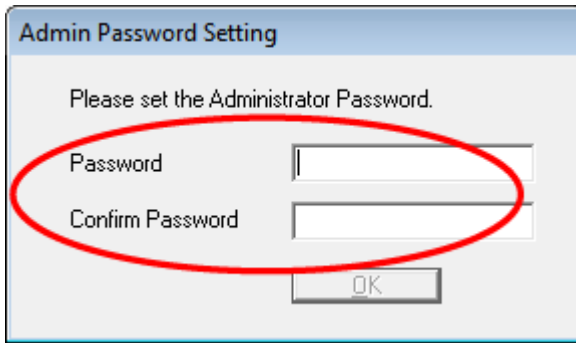

The image shows a dialog box titled "Admin Password Setting". It contains the text "Please set the Administrator Password." Below this, there are two input fields: "Password" and "Confirm Password". Both fields are currently empty. A red oval highlights both input fields. Below the input fields is an "OK" button.

CAUTION

Note that a password value is case-sensitive.

CAUTION

Be sure to keep the set password by taking a note of it, and so on.

Hint

This password is used when logging in to PowerAct Pro Monitor (see step 4 on "p.87, "6-1 Setting shutdown parameters - Using Web server software -").

26 Click the [OK] button.

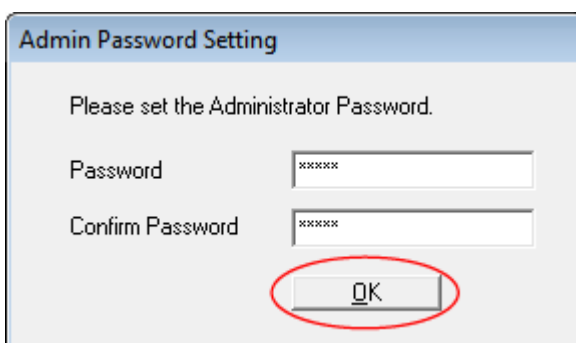

The image shows the same "Admin Password Setting" dialog box. The "Password" and "Confirm Password" fields now contain six asterisks (*****). A red oval highlights the "OK" button.

27 Click the [Finish] button to return to the Desktop window.

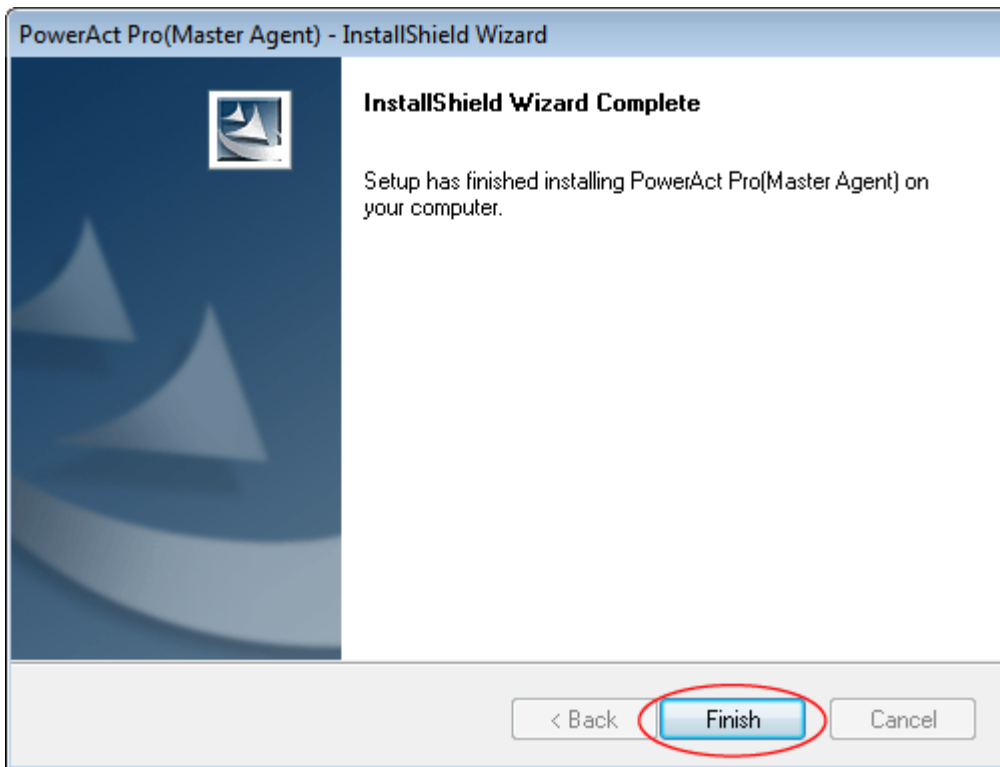

Hint

Close the "PAPV***_Master_Windows" folder if it is open.

The installation of the software using Apache is completed.

Then, proceed to p.33, "3-2 Setting Pop-up Blocker".

3-2 Setting Pop-up Blocker

- 1 Click the [Start] button, and select "Control Panel", then "Network and Internet".

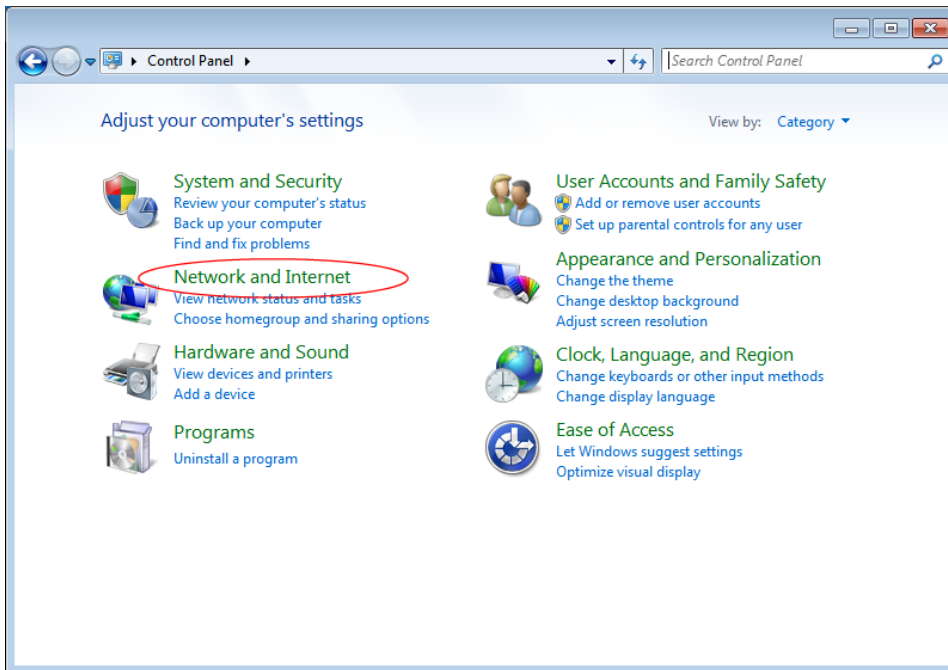

- 2 Click [Internet Options].

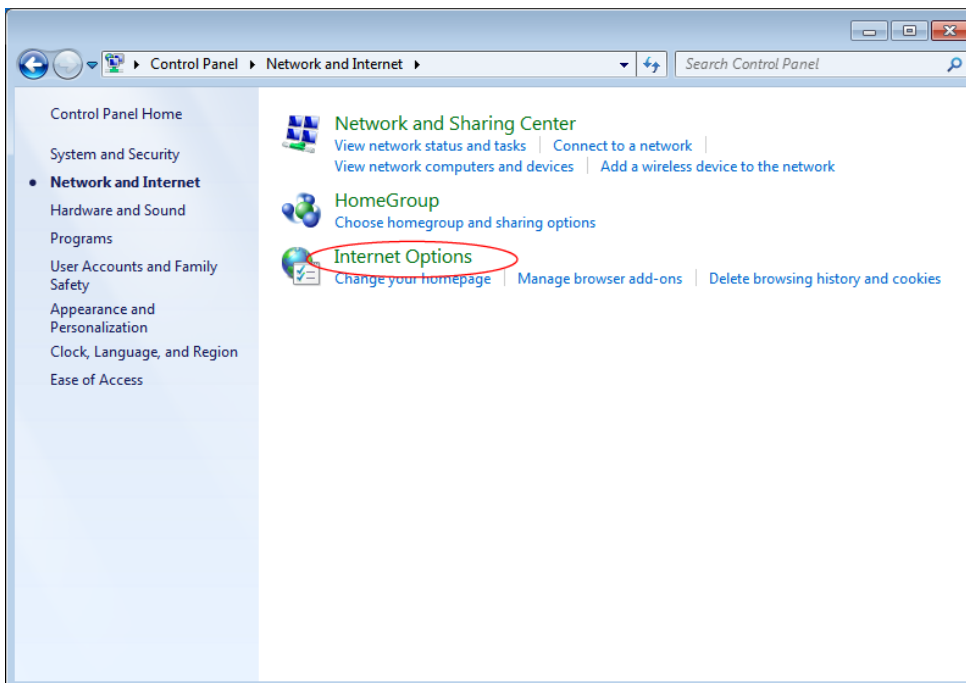

3 Click the [Privacy] tab.

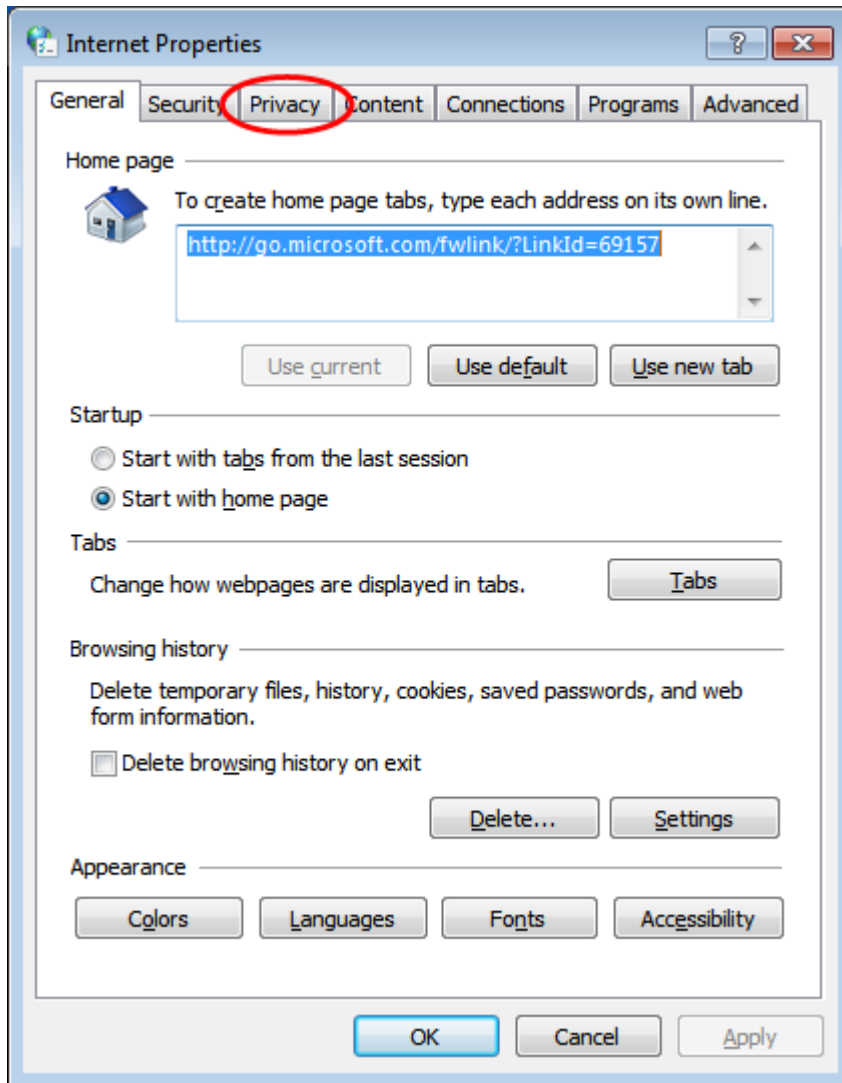

- 4 Click the [Settings] button in the [Pop-up Blocker] area.

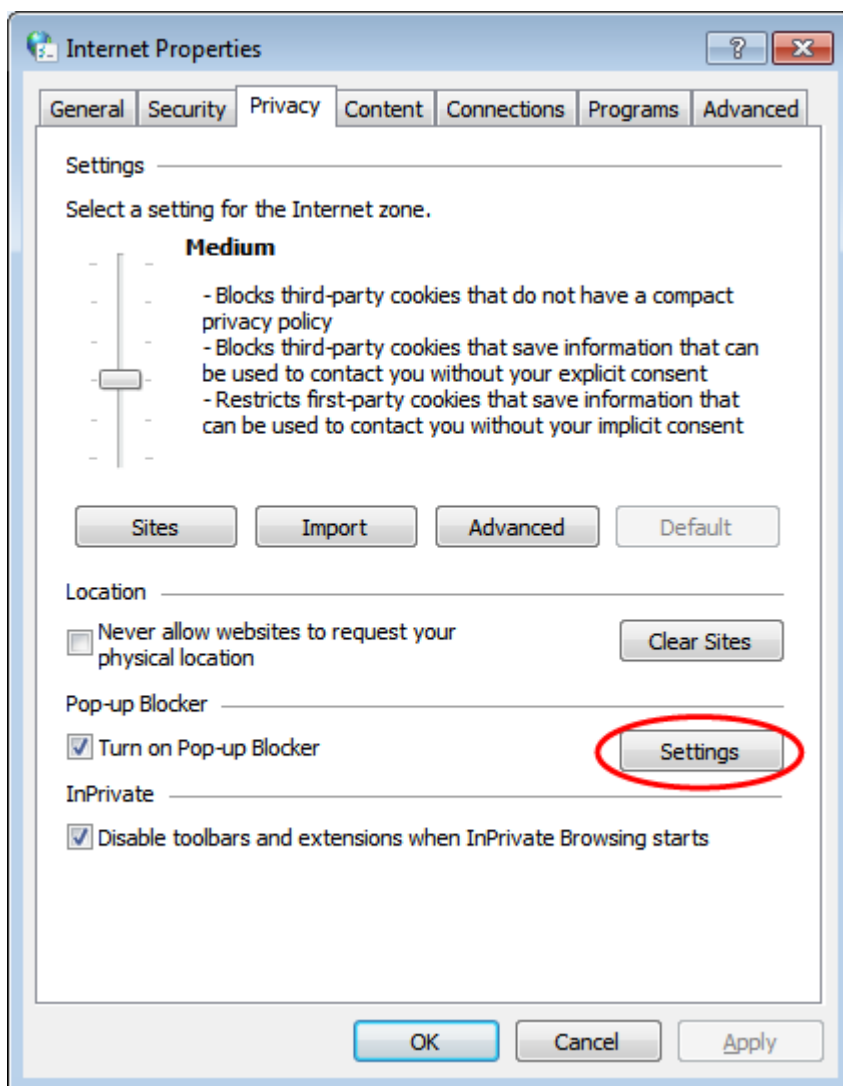

- 5 In the Pop-up Blocker Settings window, type "127.0.0.1" in the "Address of website to allow:" field, and click the [Add] button.

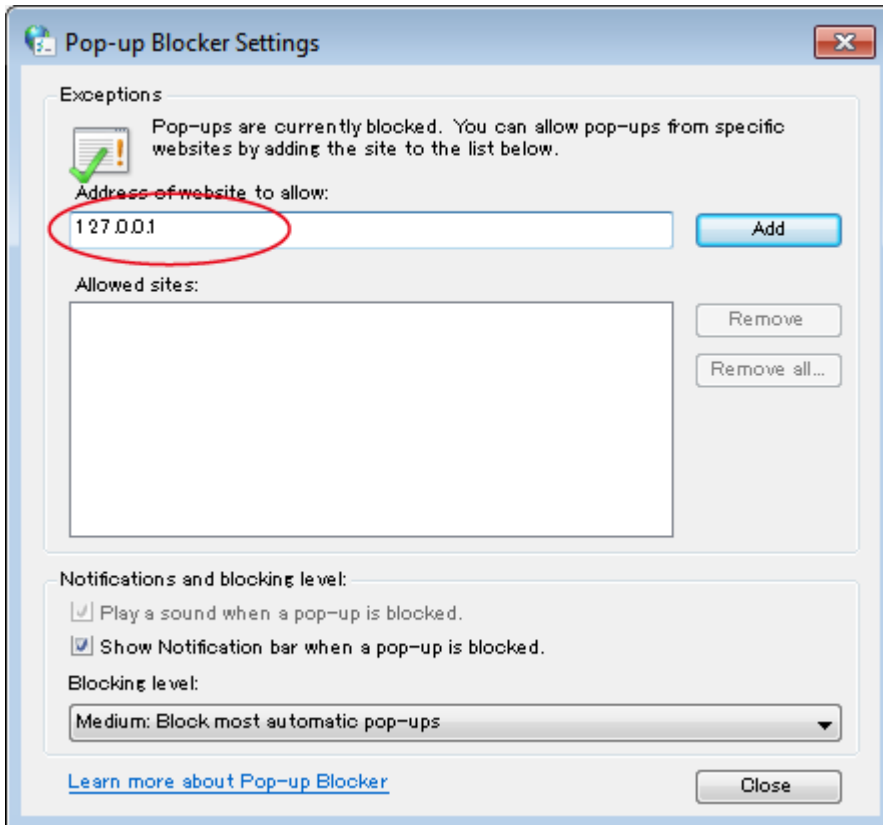

- 6 Check that "127.0.0.1" has been added to the "Allowed sites:" area, and click the [Close] button.



Then, the Pop-up Blocker setting process is completed.

If "Yes" is selected for "Do you want to use SSL communication?" in step 20 on p.27, proceed to the next step - p.38, "3-3 Installing the server certificate", and if "No" is selected, proceed to p.86, "6-1 Setting shutdown parameters - Using Web server software -".

3-3 Installing the server certificate

- 1 Click the [Start] button, and select "Control Panel", then "Network and Internet".

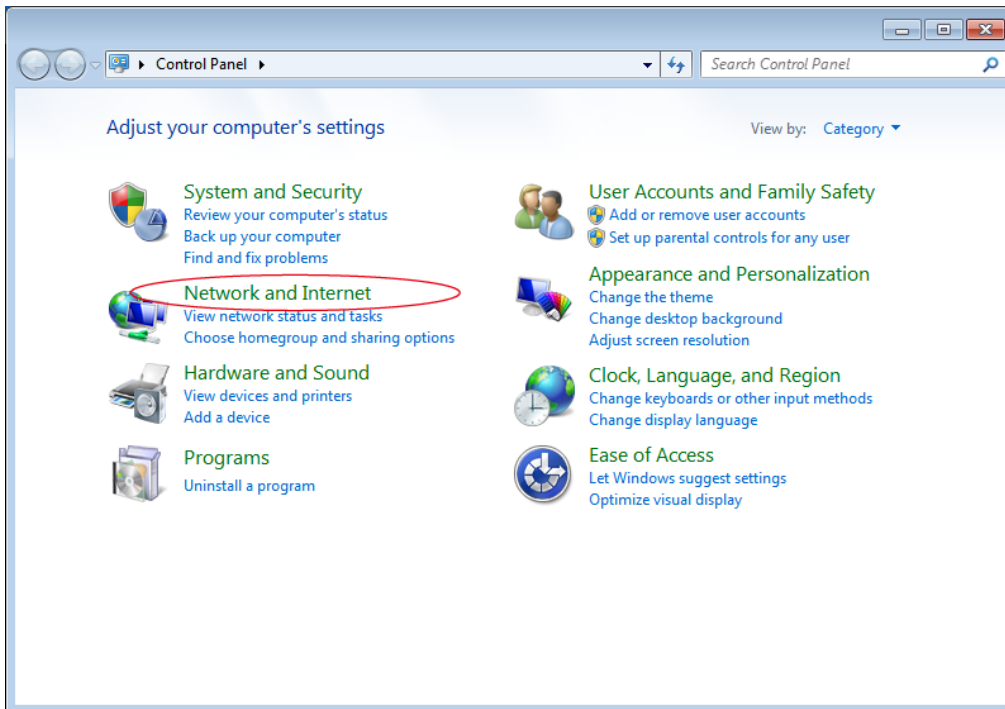

2 Select "Internet Options".

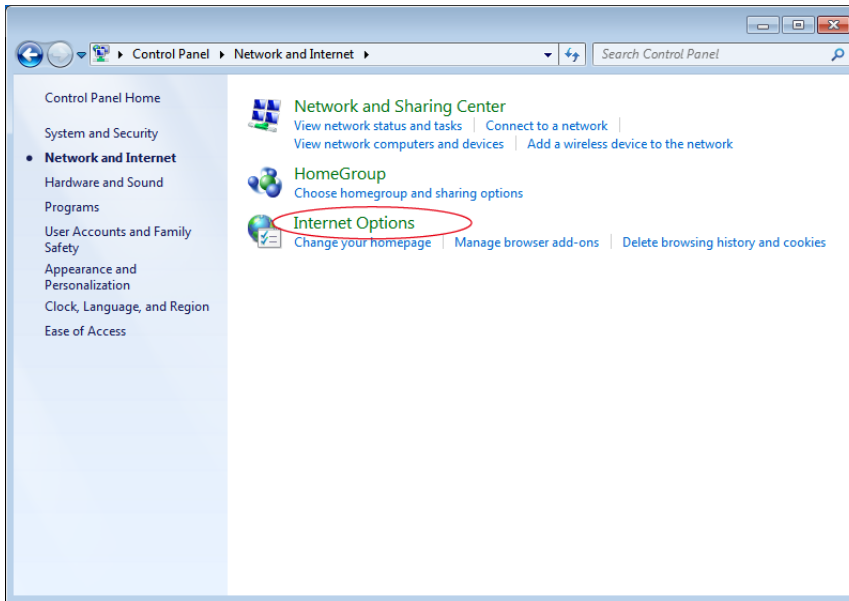

3 When the Internet Properties window appears, click the "Content" tab.

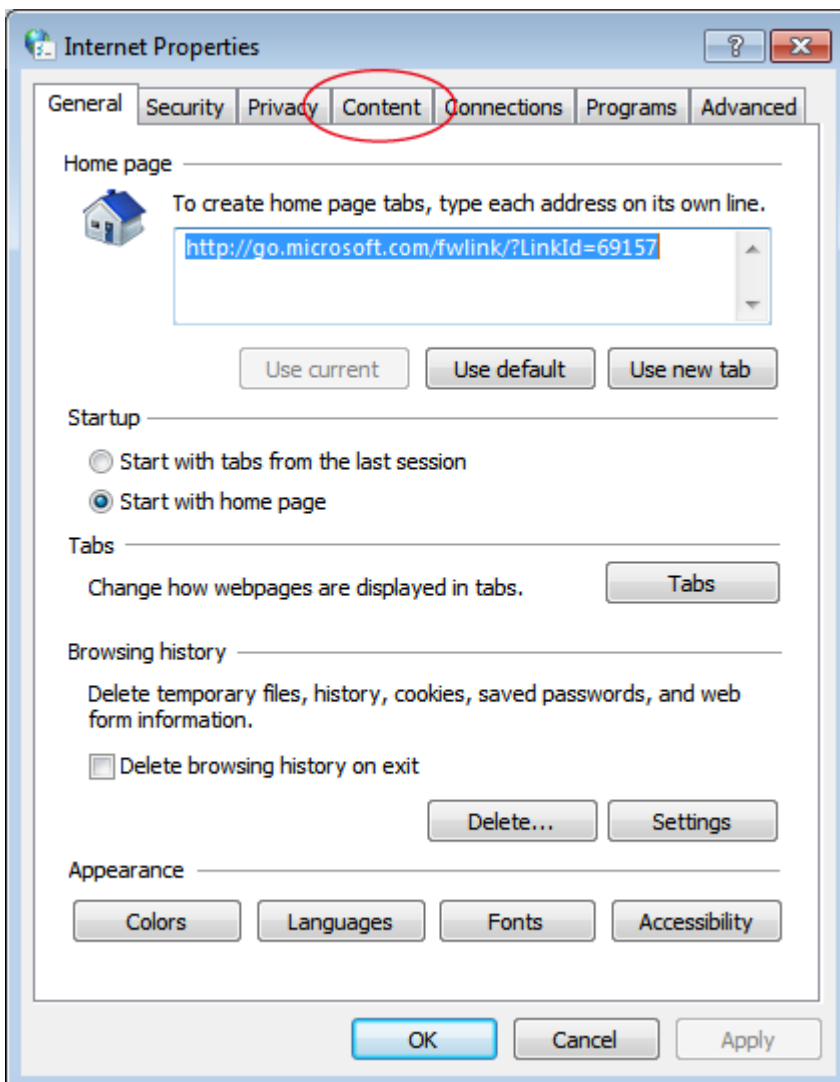

- 4 Click the [Certificates] button.

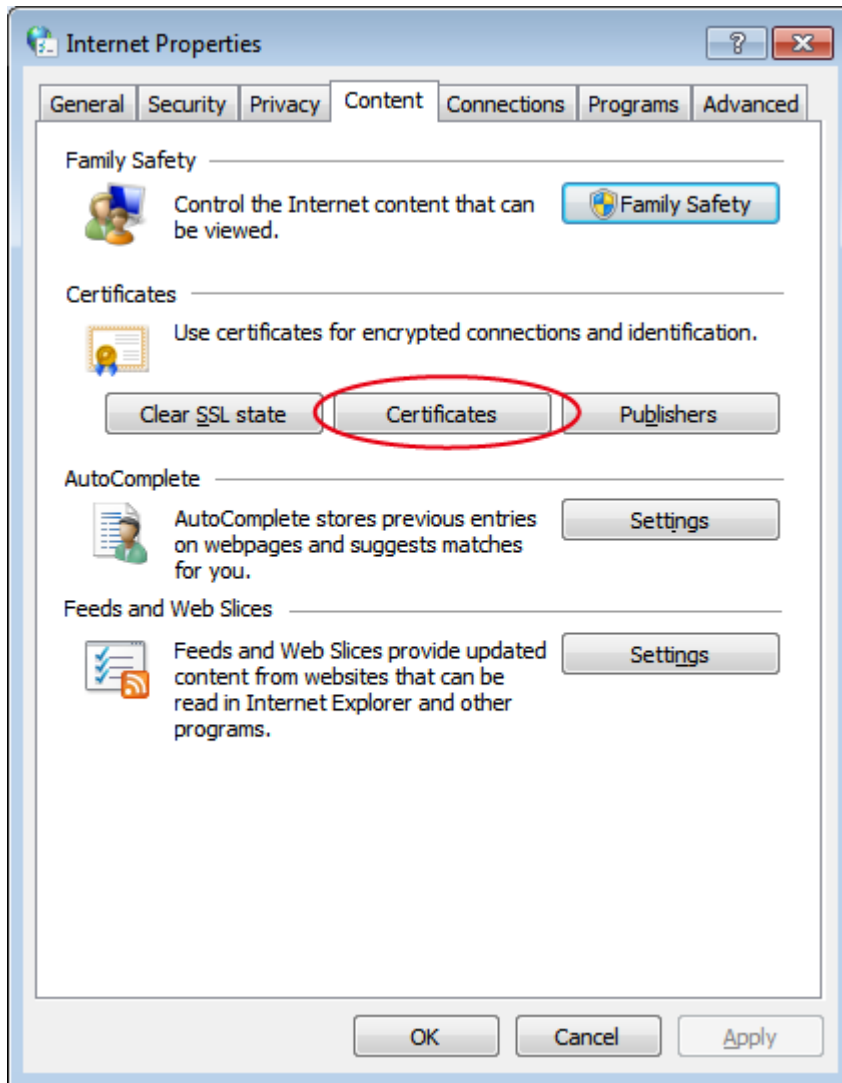

- 5 Select the "Trusted Root Certification Authorities" tab, and click the [Import...] button.

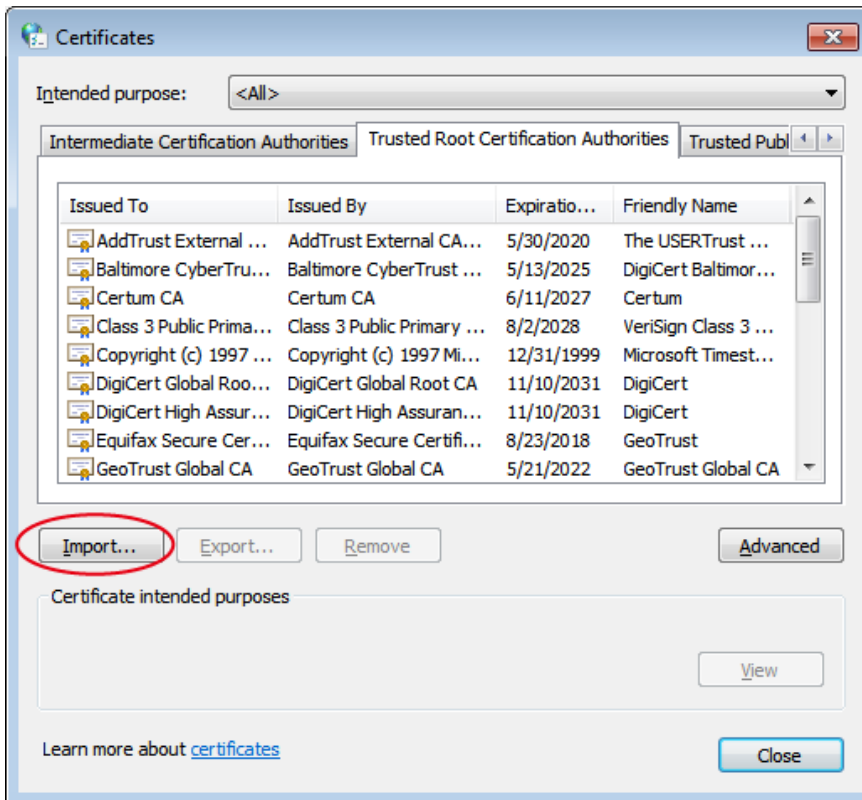

- 6 Click the [Next >] button.

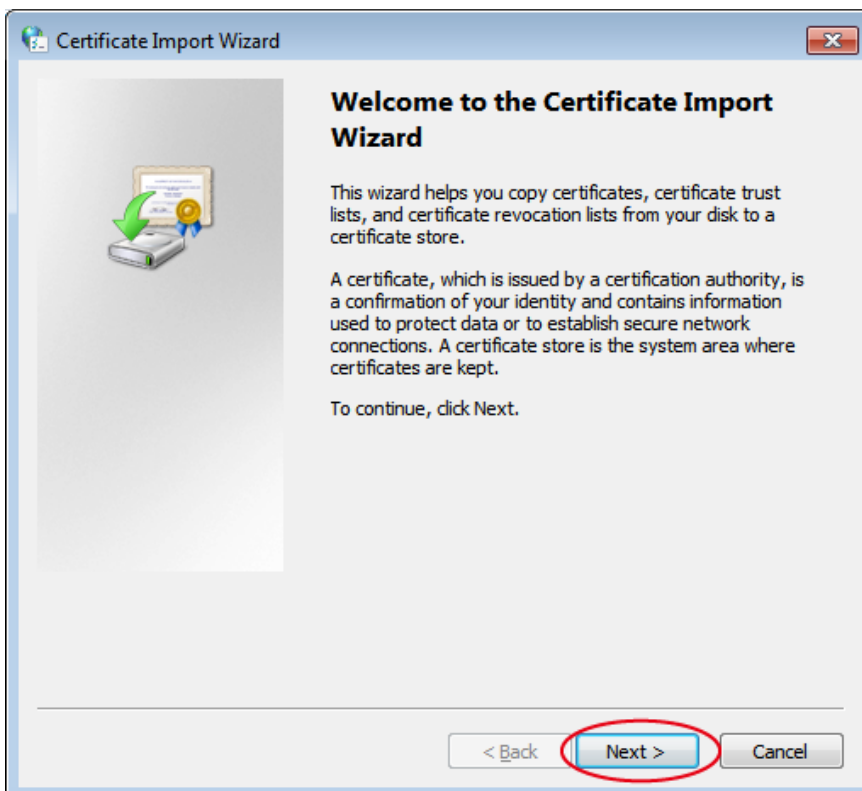

- 7 Click the [Browse...] button.

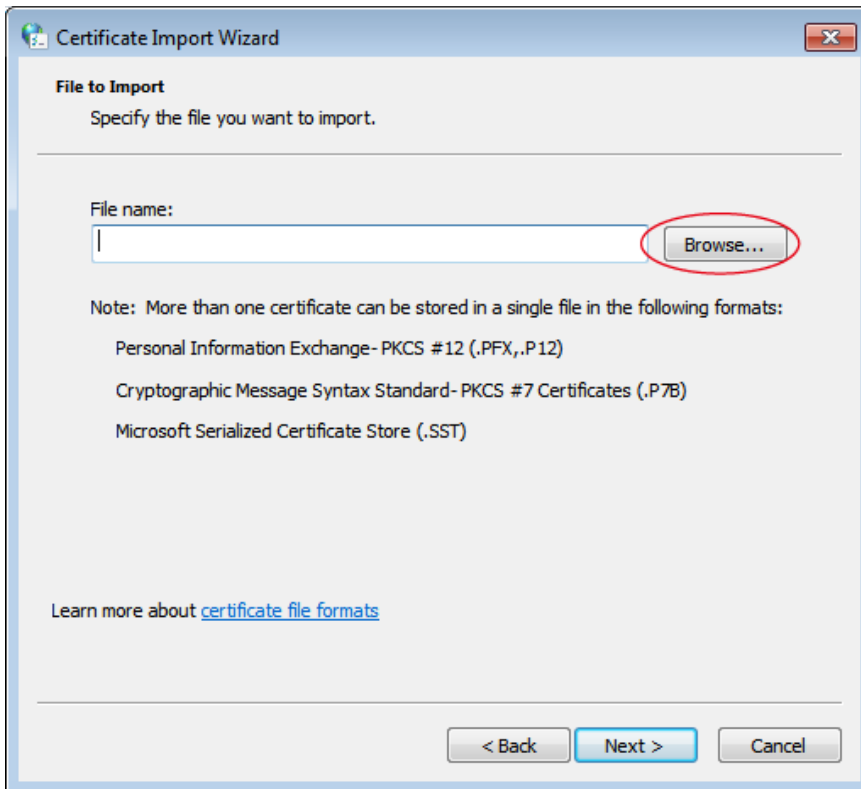

- 8 From [OS(C:)], select the [Program Files] or [Program Files(x86)] folder, [Apache2.2.8] folder, the [conf] folder, then "server.crt", and click the [Open] button.

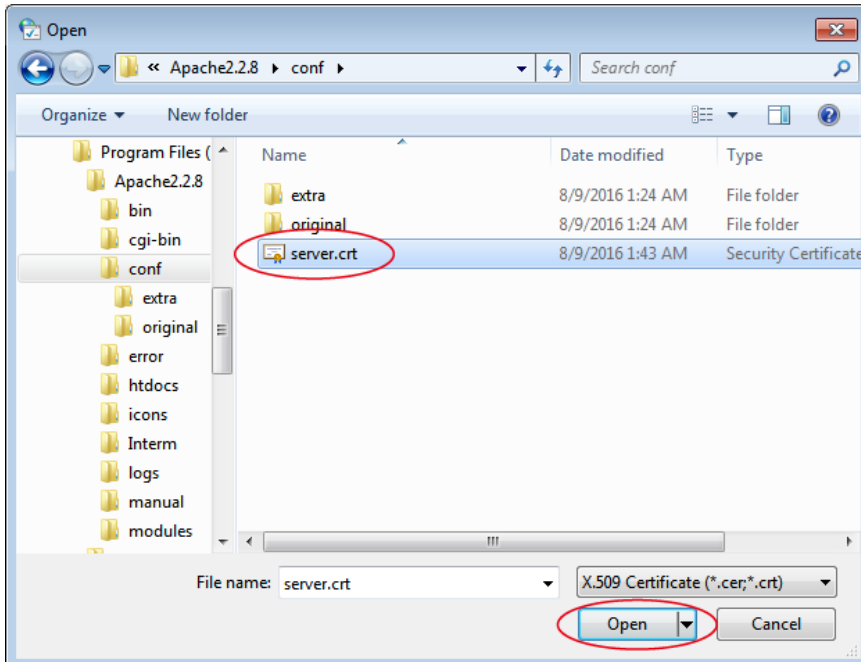

Hint

The location where "server.crt" is installed by default differs depending on the OS.

32-bit OS: C:\Program Files\Apache2.2.8\conf

64-bit OS: C:\Program Files(x86)\Apache2.2.8\conf

- 9 When the Certificate Import Wizard window appears again, click the [Next >] button.

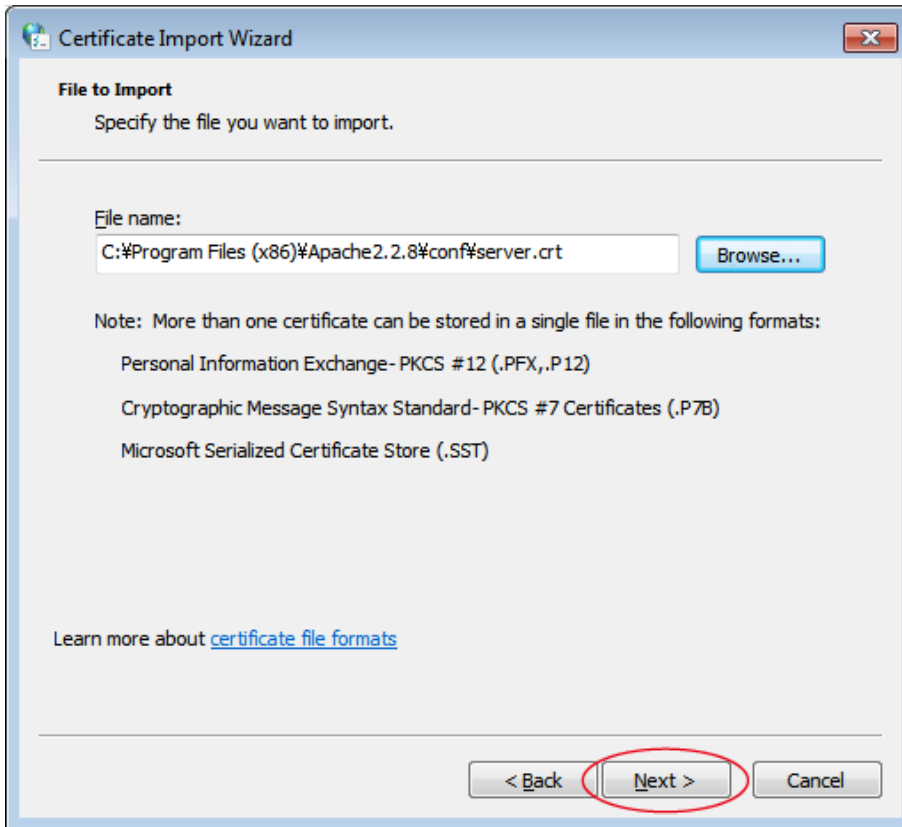

- 10 Click the [Next >] button.

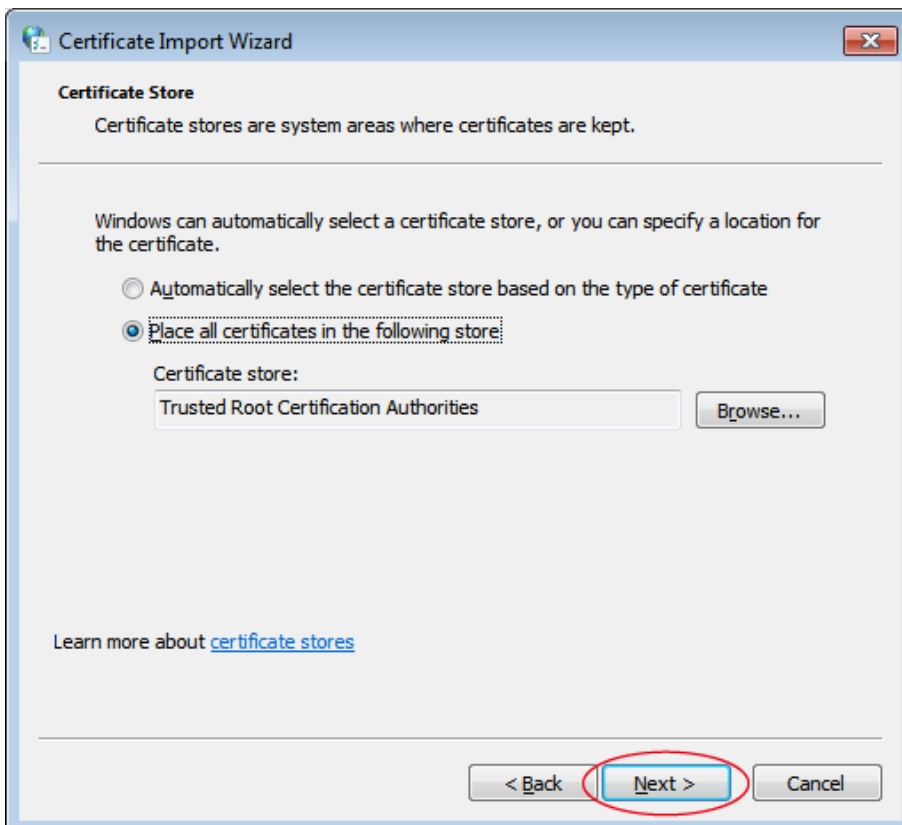

11 Click the [Finish] button.

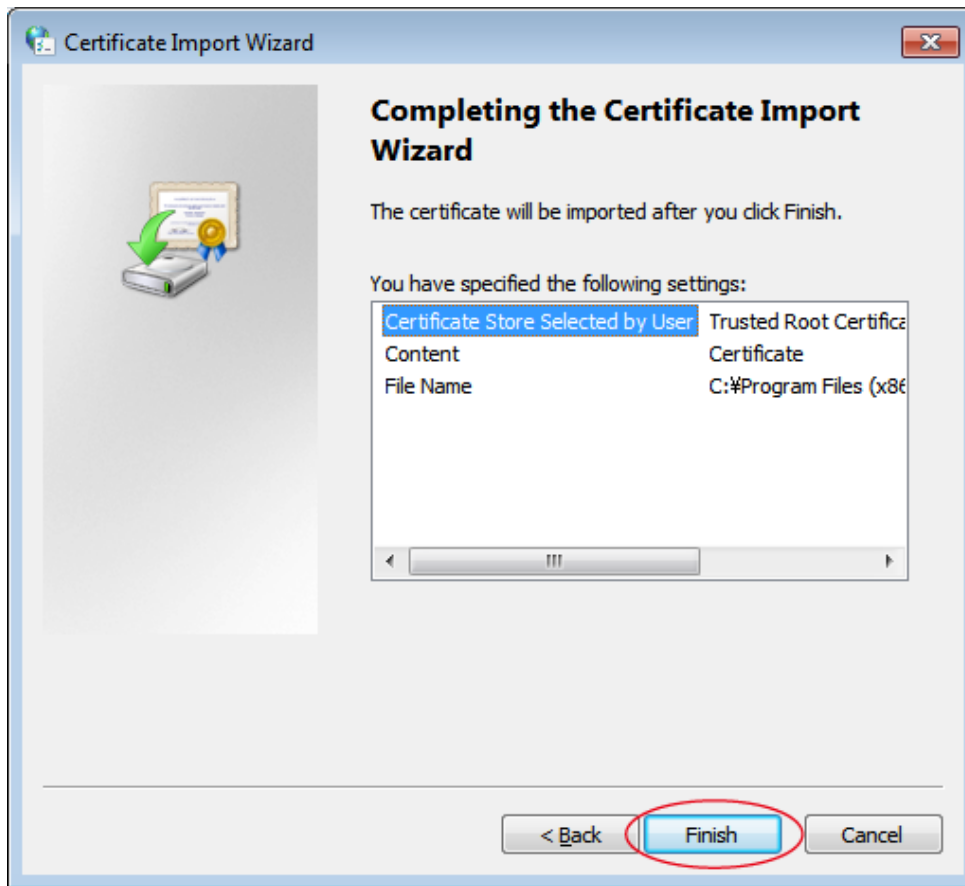

12 If a warning window appears, click the [Yes] button.

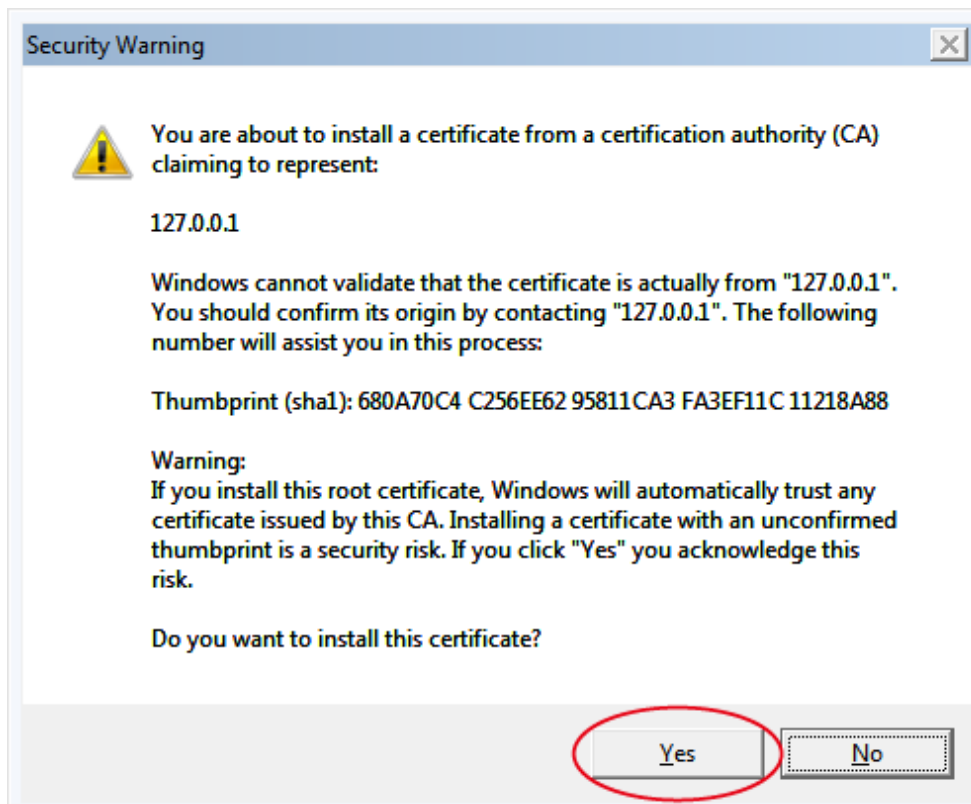

13 Click the [OK] button.

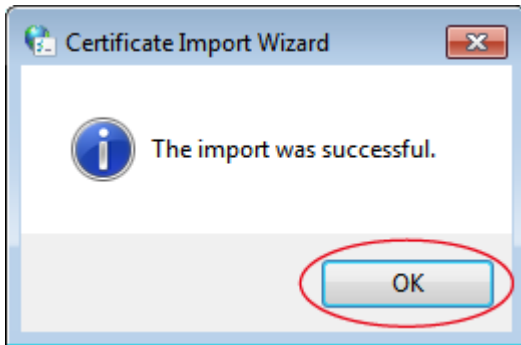

14 Click the [Close] button.

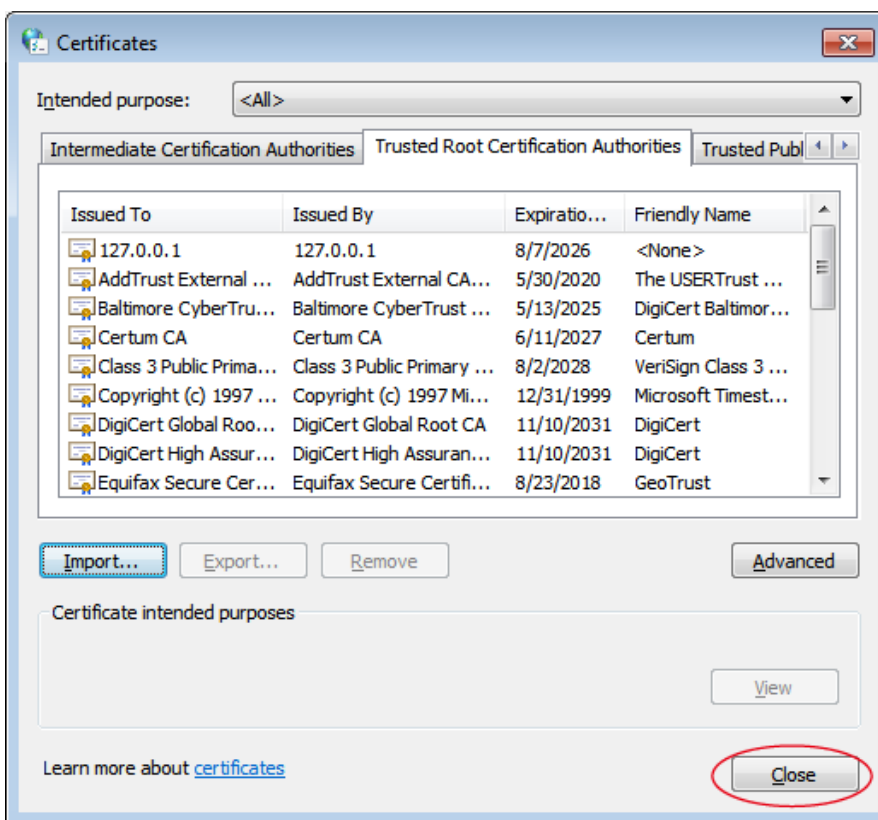

Hint

Close the Internet Properties window or the Network and Internet window if it is open.

The installation of the server certificate when using Apache is completed.

Then, proceed to p.86, "6-1 Setting shutdown parameters - Using Web server software -".

4 Installation Method - Using IIS -

4-1 Enabling and setting IIS

- 1 Click the [Start] button, and select [Control Panel], then [Programs].

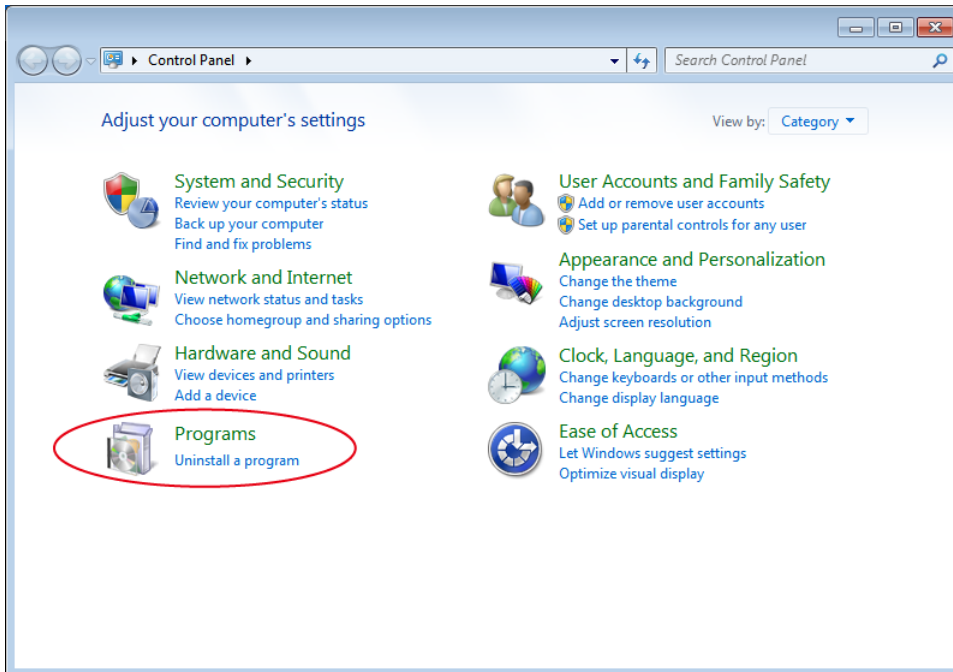

- 2 Select [Programs and Features].

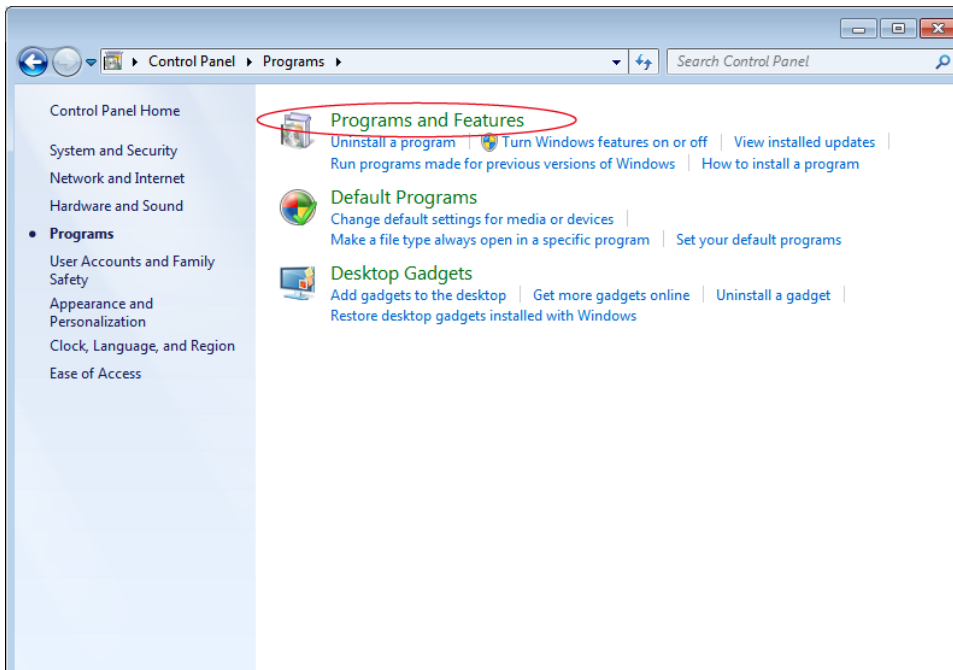

3 Select [Turn Windows features on or off].

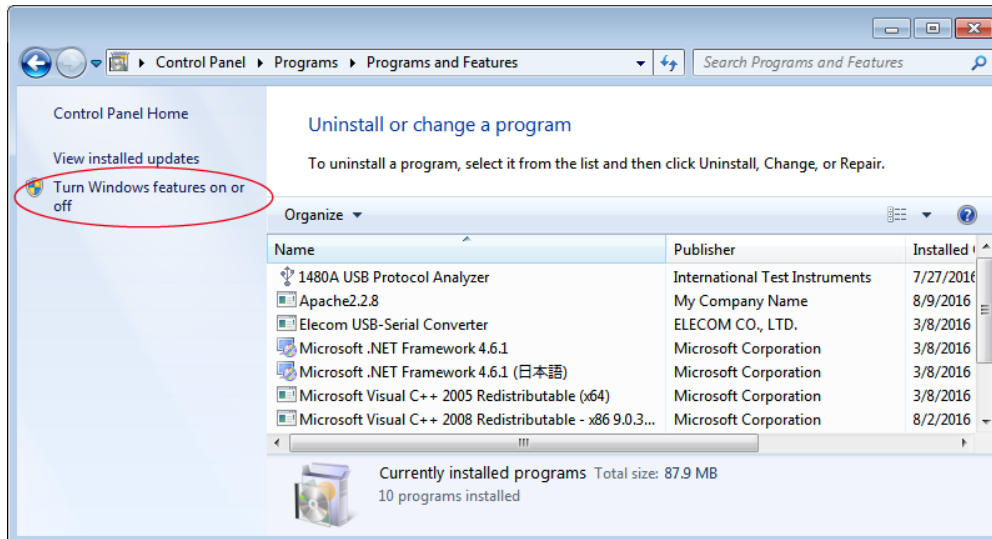

- 4 In the Windows Features window, select "Internet Information Services" and select the check boxes as shown in the following image, and click the [OK] button.

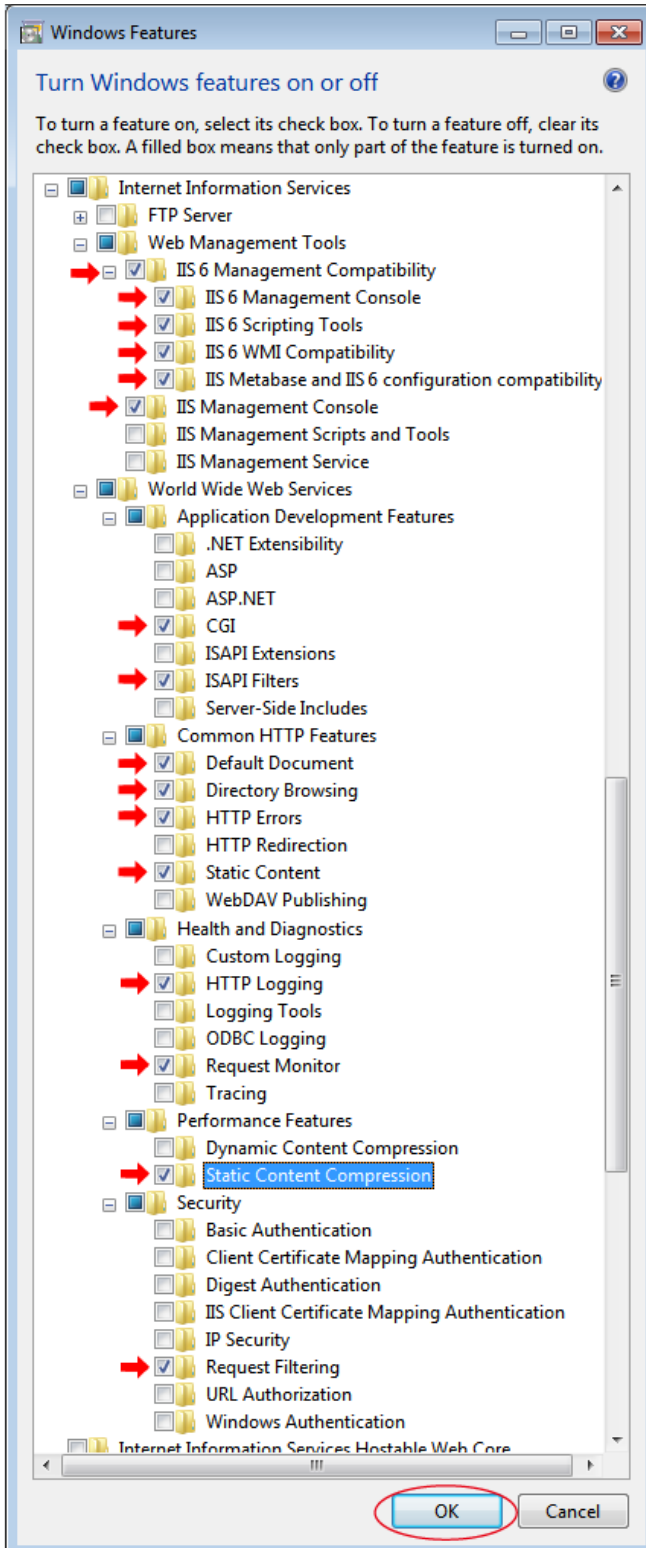

- 5 Close the Programs and Features window.

Then, IIS is enabled and set completely.

4-2 Installing the software

- 1 Please download the PowerAct Pro software from OMRON's Web site.

File name: PAPV***_Master_Windows.zip (Remark: *** is Number from 0 to 9 <Ex:515>)

- 2 Unzip the download file "PAPV***_Master_Winodws.zip".

Hint

If start unzip operation for "PAPV***_Master_Windows.zip", the "PAPV***_Master_Windows" folder create automatically.

- 3 Open the "PAPV515_Master_Windows" folder and then double click "Setup.exe".

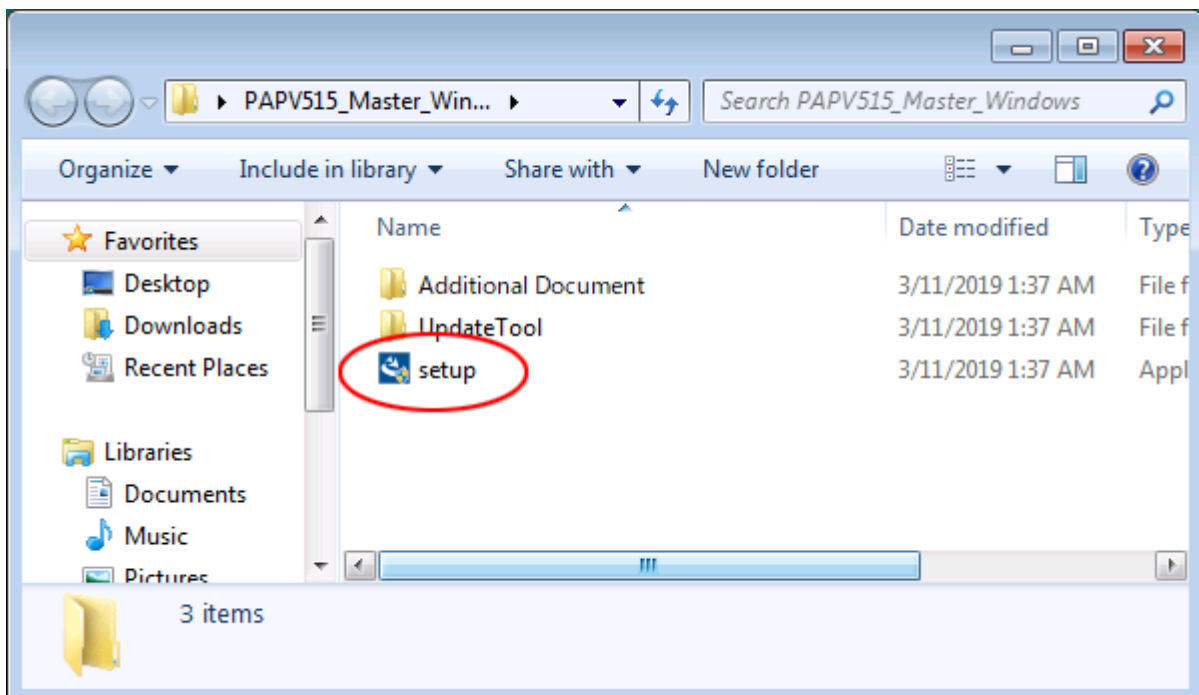

- 4 Click the [Yes] button.

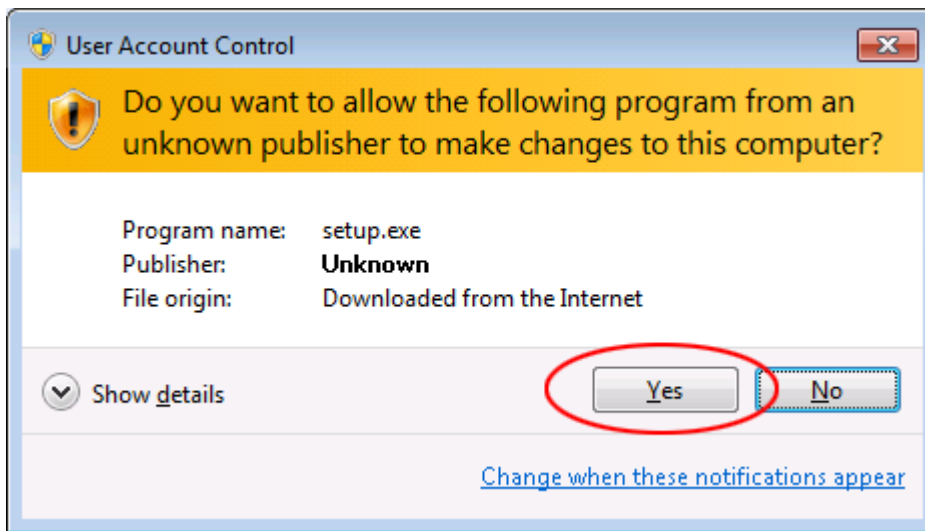

- 5 Click the [Next >] button.

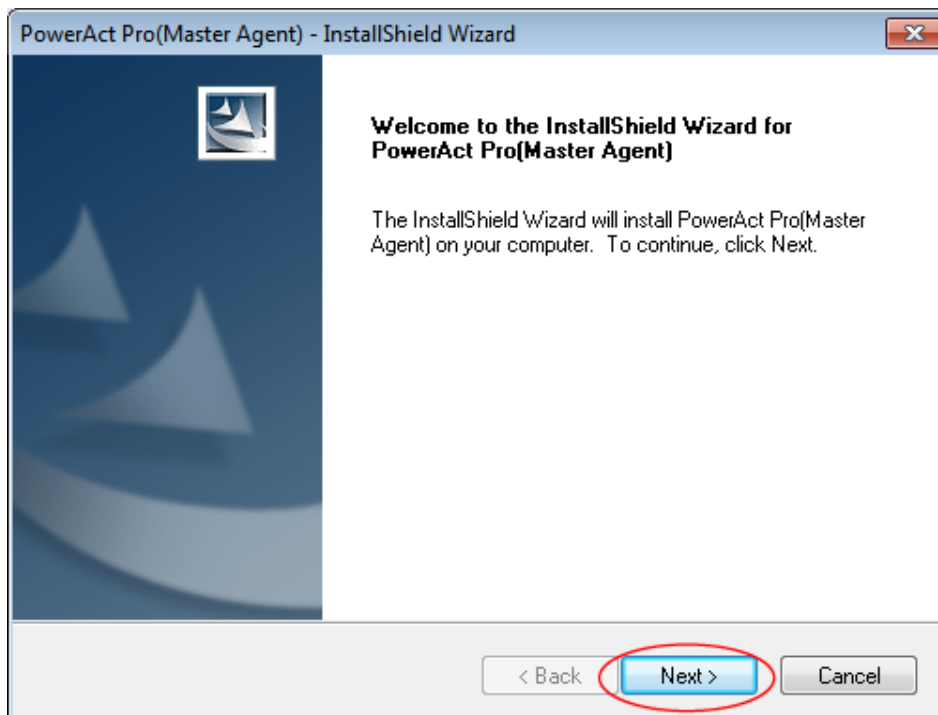

- 6 Read the contents of "License Agreement" carefully, select the radio button for "I accept the terms of the license agreement", and click the [Next >] button.

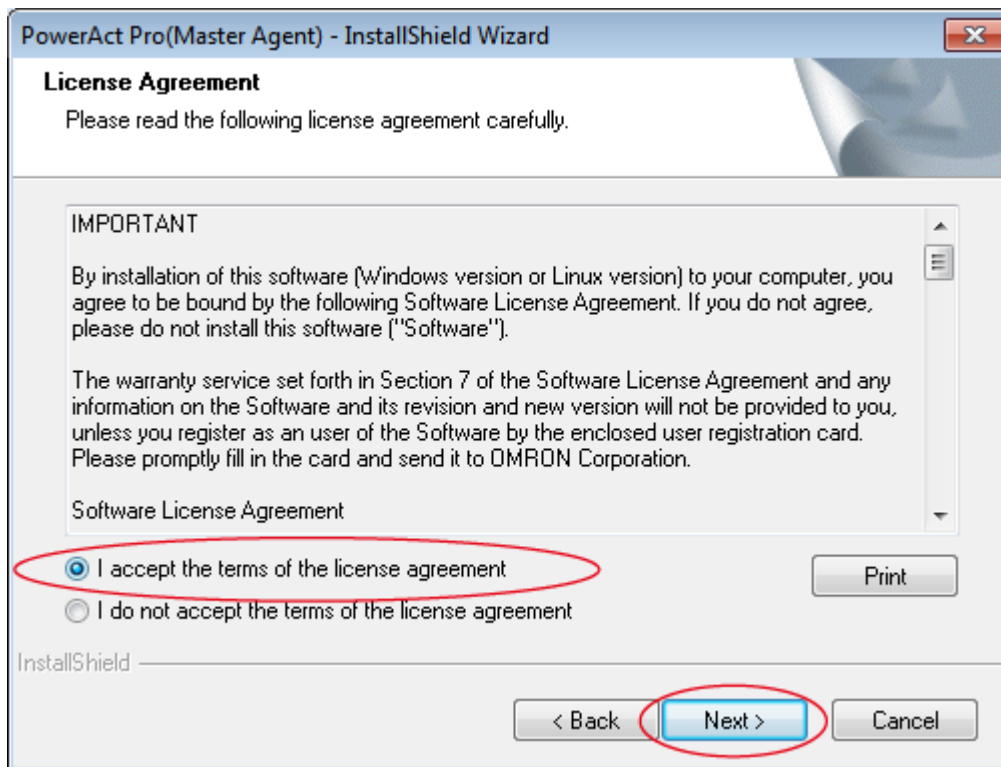

Hint

If you do not accept the terms of the license agreement, you can not use the software.
In that case, click the [Cancel] button to stop the installation process.

- 7 Select the radio button for "Standard Install [Enable network function]", and click the [Next >] button.

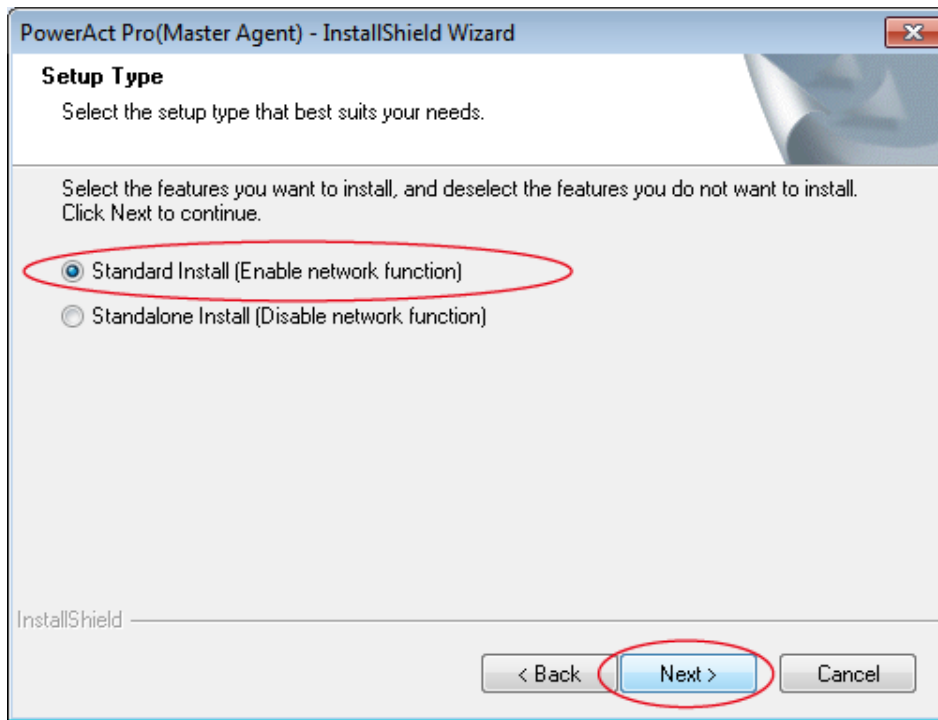

Hint

When "Standard Install" is selected, you can use the following via the network.

- Checking, setting, and controlling UPS information in the Web Monitor window of a computer on the network
- Shutting down a computer where Slave Agent is installed
- Shutdown warning using SNMP and notification of UPS operation information to specified computers

- 8 Select the radio button for "Use IIS Web Server" and click the [Next >] button.

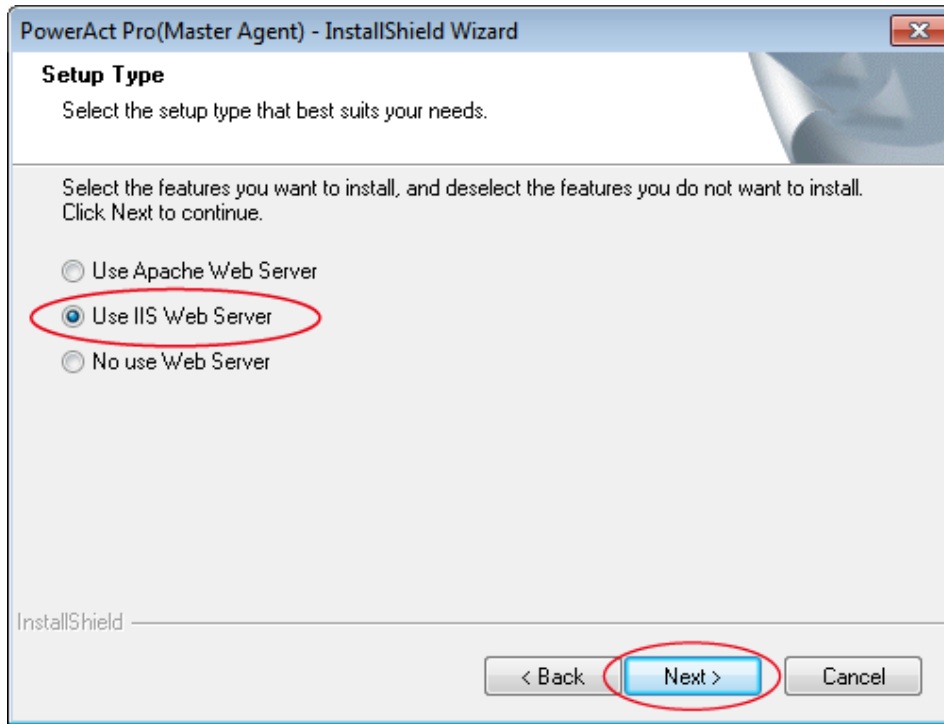

- 9 Click the [Next >] button.

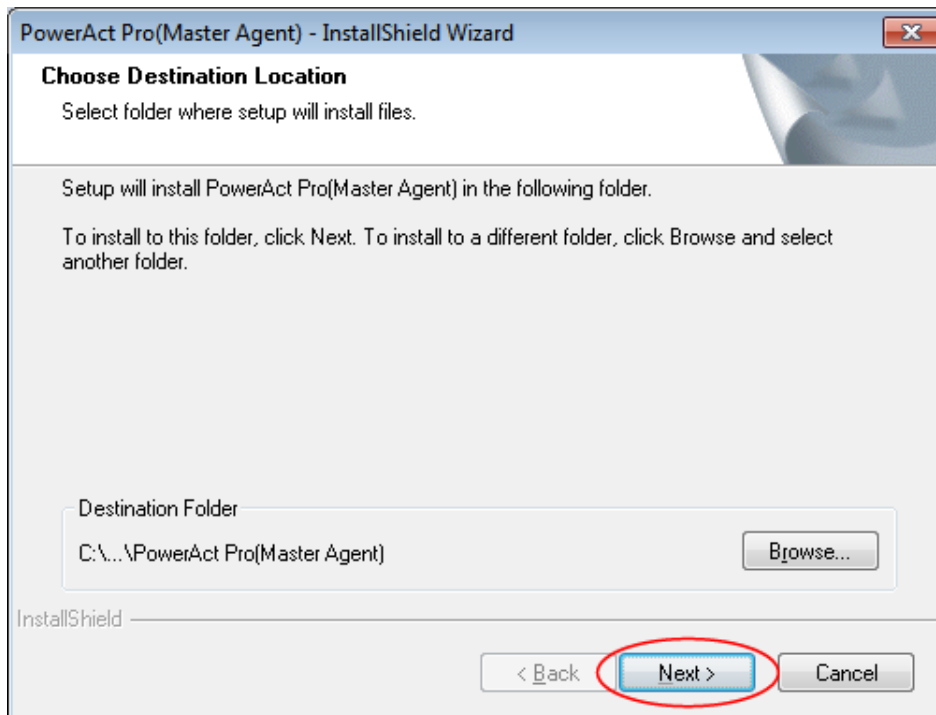
**CAUTION**

Do not install the software in a write-protected folder or network drive.
Be sure to install it in the read and write permitted hard disk drive in the local computer.

Hint

In this window, you can change the installation destination location for the software. To change the installation destination location for the software, click the [Browse...] button, specify the installation destination location, and click the [Next >] button.

10 Click the [Next >] button.

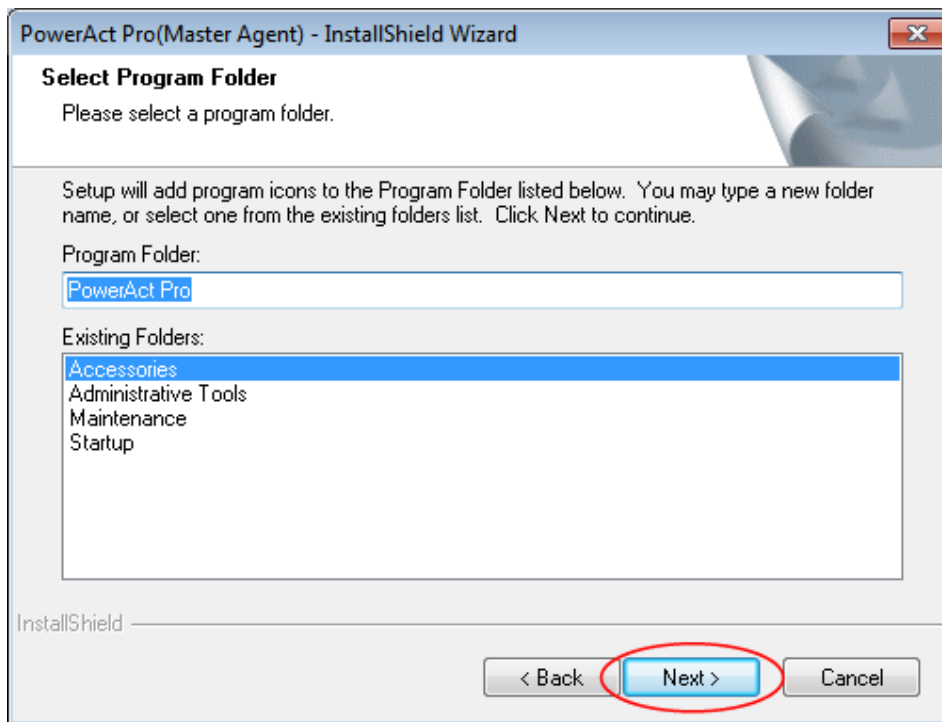

11 Click the [Next >] button.

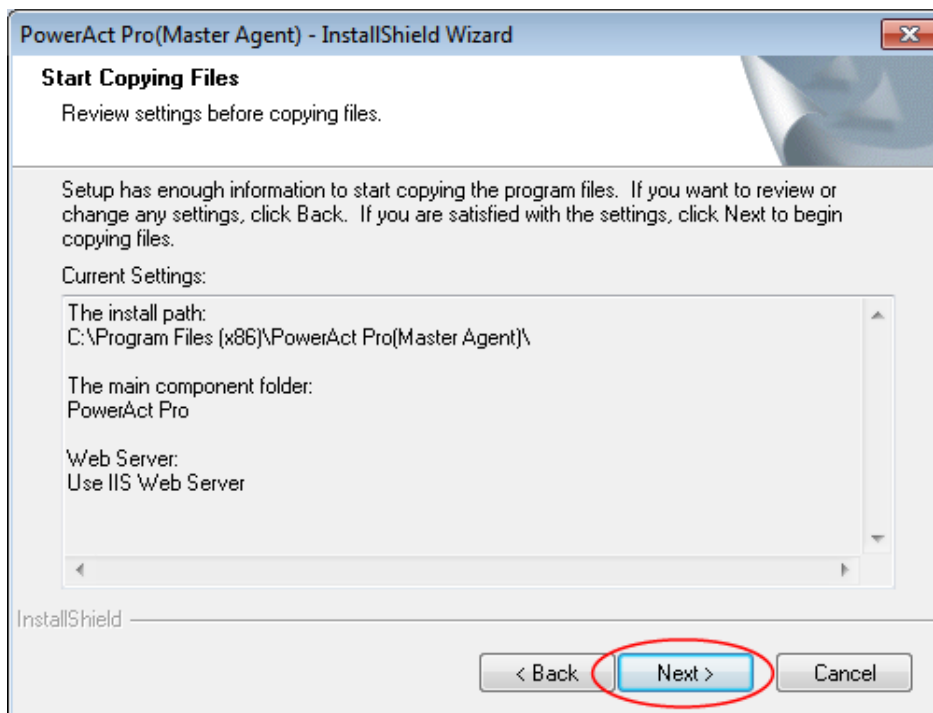

12 Click the [No] button.

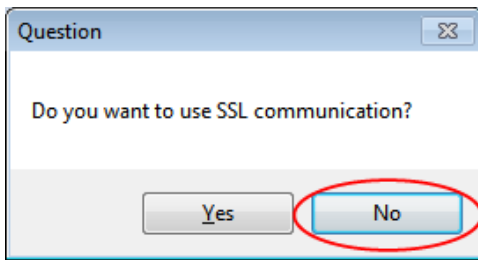

Hint

To use encrypted communication, select [Yes]. When the Certificate at PowerAct Pro window appears, click the [OK] button.

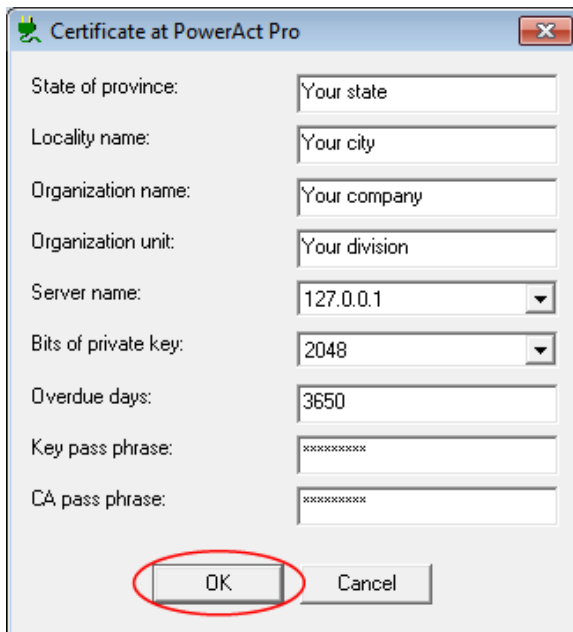

When PowerAct Pro has been installed completely, install "Server Certificate" (see p.66, "4-4 Installing the server certificate").

13 Select either "Auto" or "Manual", and click the [OK] button.

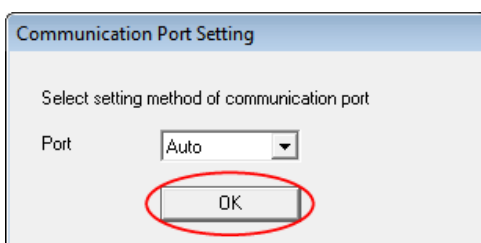

Hint

When "Auto" is selected, the COM ports, and then USB ports are searched to find the connected UPS.
When "Manual" is selected, only the set COM port is searched (see p.126, "7-25 Selecting "Manual" in "Communication Port Setting").

14 Check the result, and click the [OK] button.

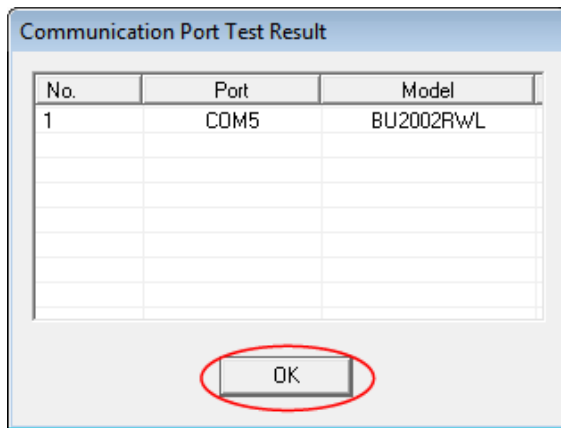

Hint

If no result is displayed for "Communication Port Test Result", communication between the software and the UPS is not established. However, there is no problem with the installation process itself, so click the [OK] button, and proceed to step 17. If you want your computer to communicate with the UPS at this point, see p.109, "7-2 Unable to communicate with the UPS".

Hint

If no result is displayed for "Communication Port Test Result" in step 15, neither the window in step 16 nor the window in step 17 is displayed.

15 Enter values for "UPS Start Date:", "Battery Use Date (Battery Change Date):", and "Next Battery Replace Date:", and click the [OK] button.

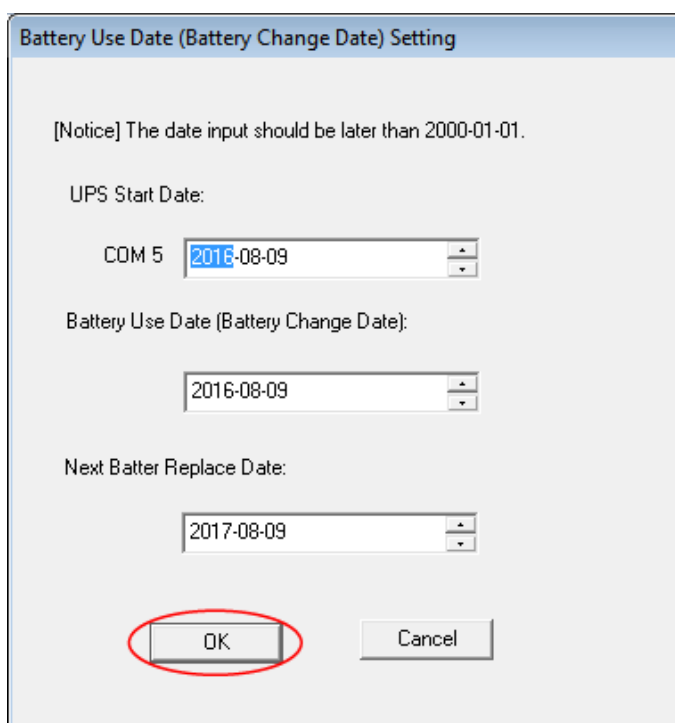

16 Click the [OK] button.

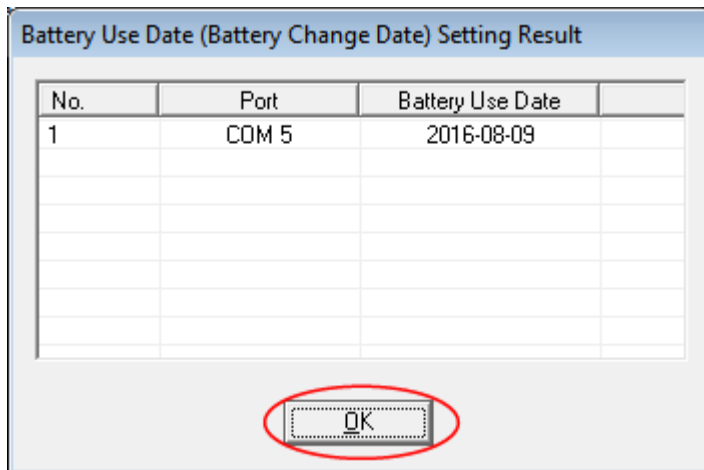

17 Click the [OK] button.

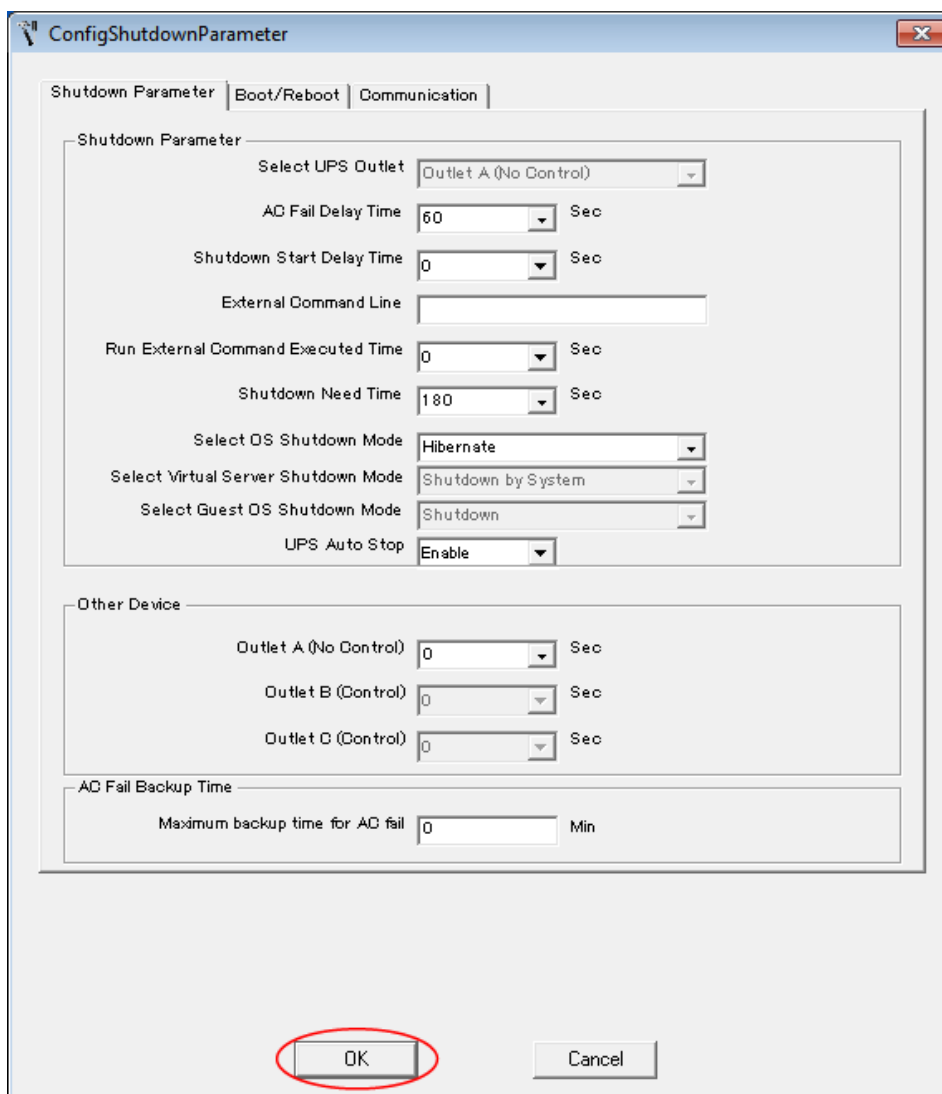

Hint

After the installation process is completed, you can also set the shutdown operation in "Configuration" of [PowerAct Pro Monitor] (see p.86, "6-1 Setting shutdown parameters - Using Web server software -").

18 Specify the password in 1 to 15 single-byte alphanumeric characters (A to Z, a to z, 0 to 9).

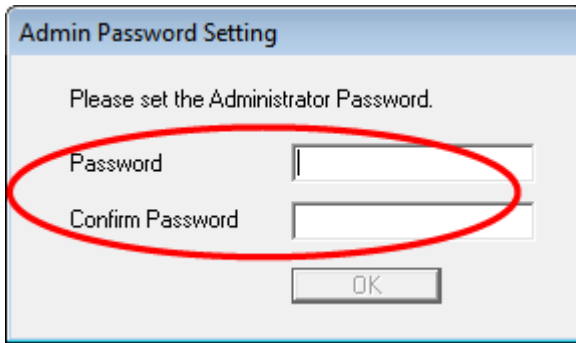

The image shows a dialog box titled "Admin Password Setting". It contains the instruction "Please set the Administrator Password." Below this, there are two text input fields: "Password" and "Confirm Password". Both fields are currently empty. A red oval highlights both input fields. At the bottom of the dialog is an "OK" button.

CAUTION

Note that a password value is case-sensitive.

CAUTION

Be sure to keep the set password by taking a note of it, and so on.

Hint

This password is used when logging in to PowerAct Pro Monitor (see step 4 on "p.87, "6-1 Setting shutdown parameters - Using Web server software -").

19 Click the [OK] button.

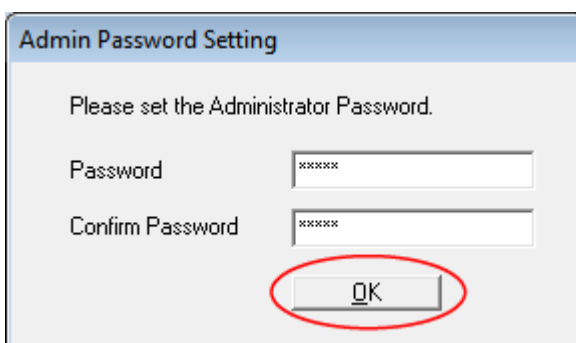

The image shows the same "Admin Password Setting" dialog box as in the previous step. The "Password" and "Confirm Password" fields now contain six asterisks (*****). A red oval highlights the "OK" button at the bottom of the dialog.

20 Click the [Finish] button to return to the Desktop window.

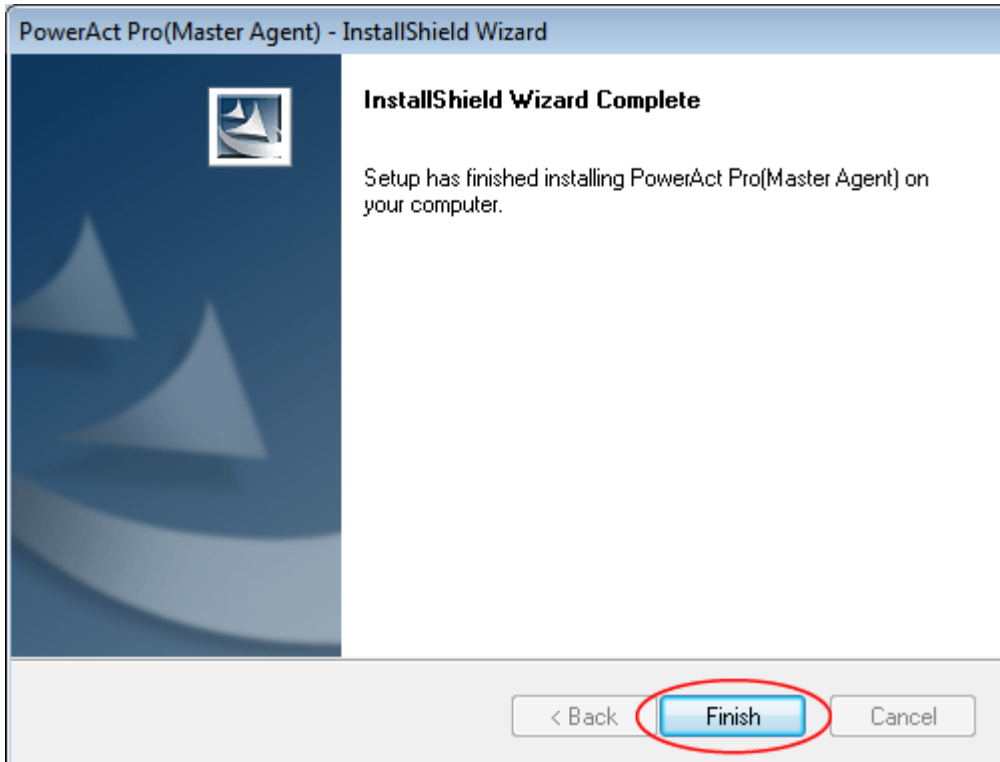

Hint

Close the "PAPV***_Master_Windows" folder if it is open.

The installation of the software using IIS is completed.

Then, proceed to p.61, "4-3 Setting Pop-up Blocker".

4-3 Setting Pop-up Blocker

- 1 Click the [Start] button, and select "Control Panel", then "Network and Internet".

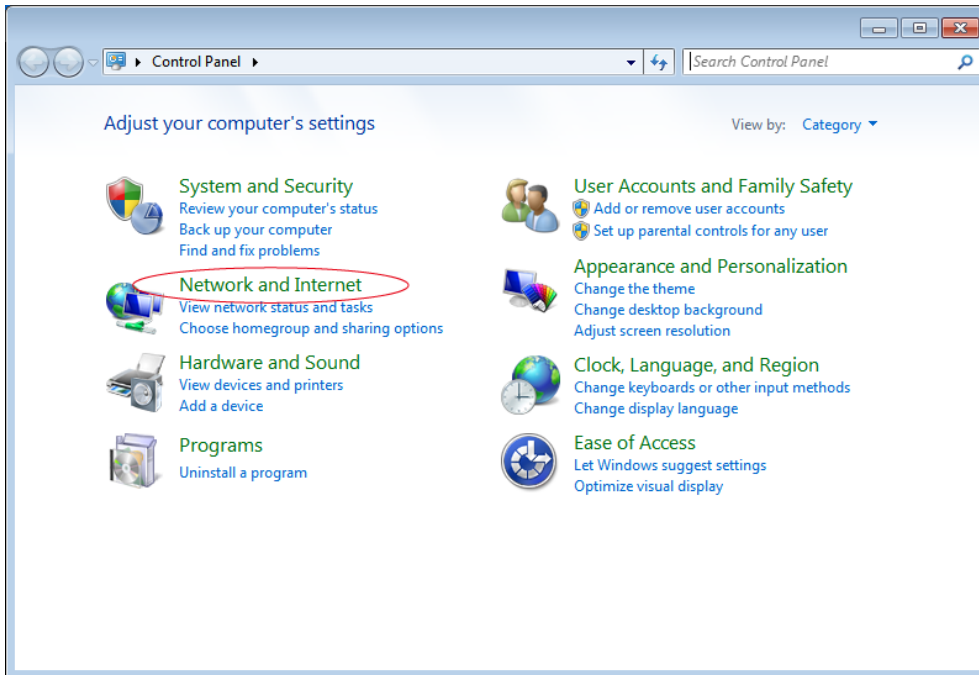

- 2 Click [Internet Options].

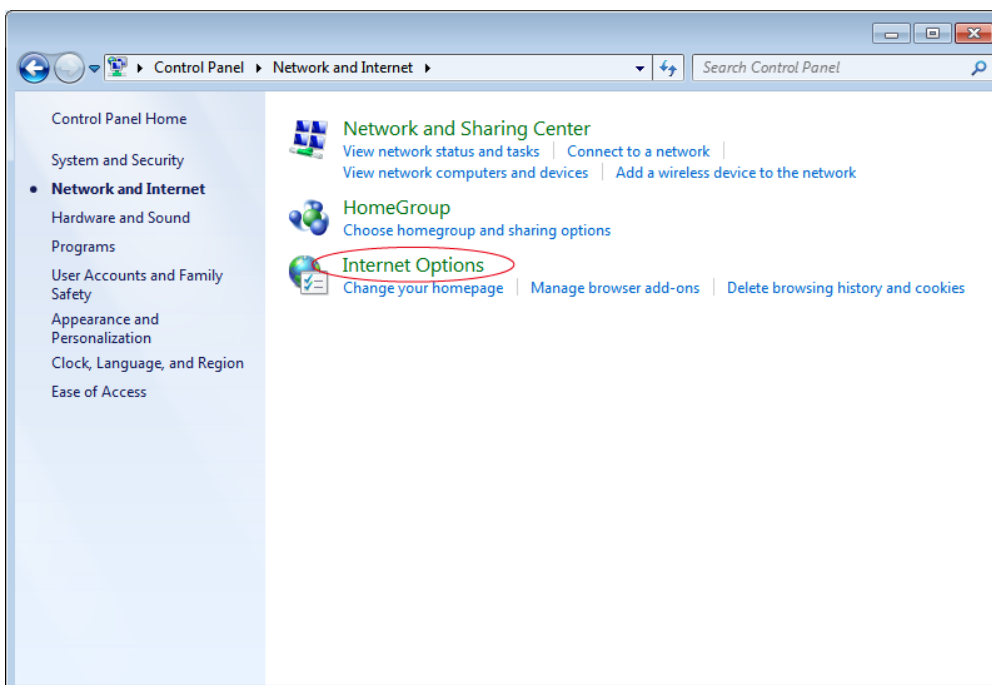

3 Click the [Privacy] tab.

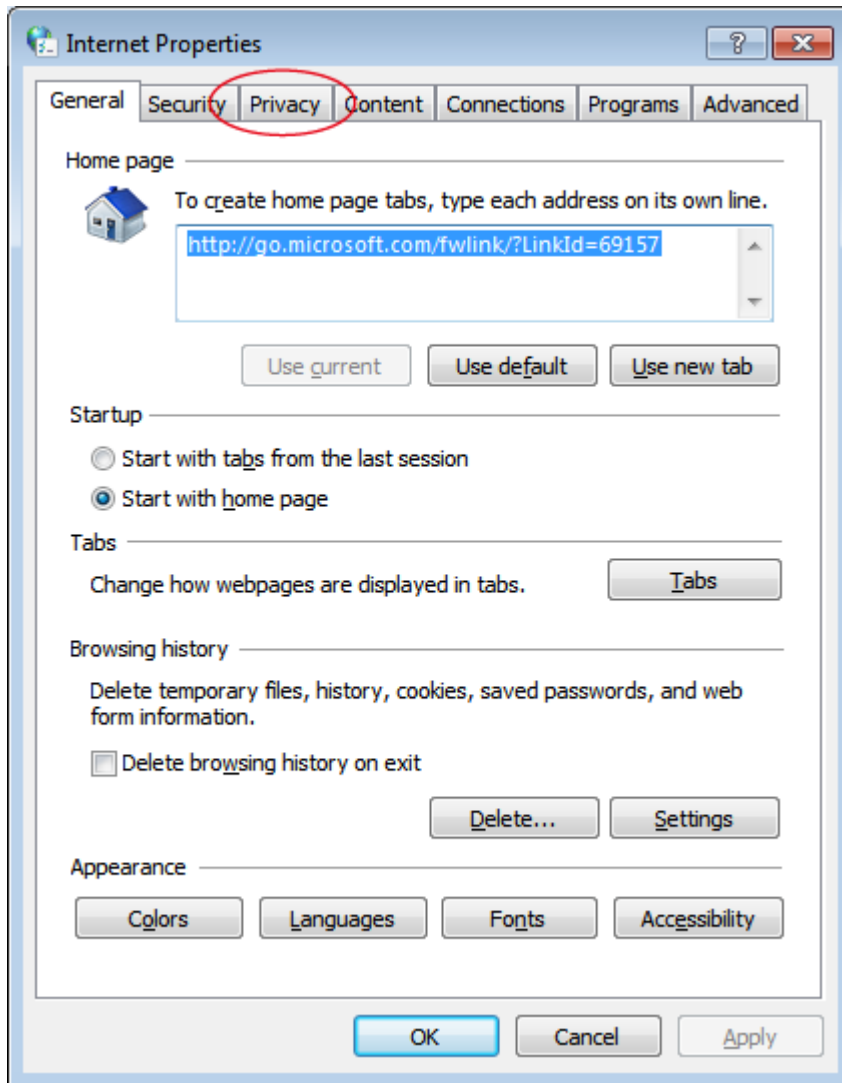

- 4 Click the [Settings] button in the "Pop-up Blocker" area.

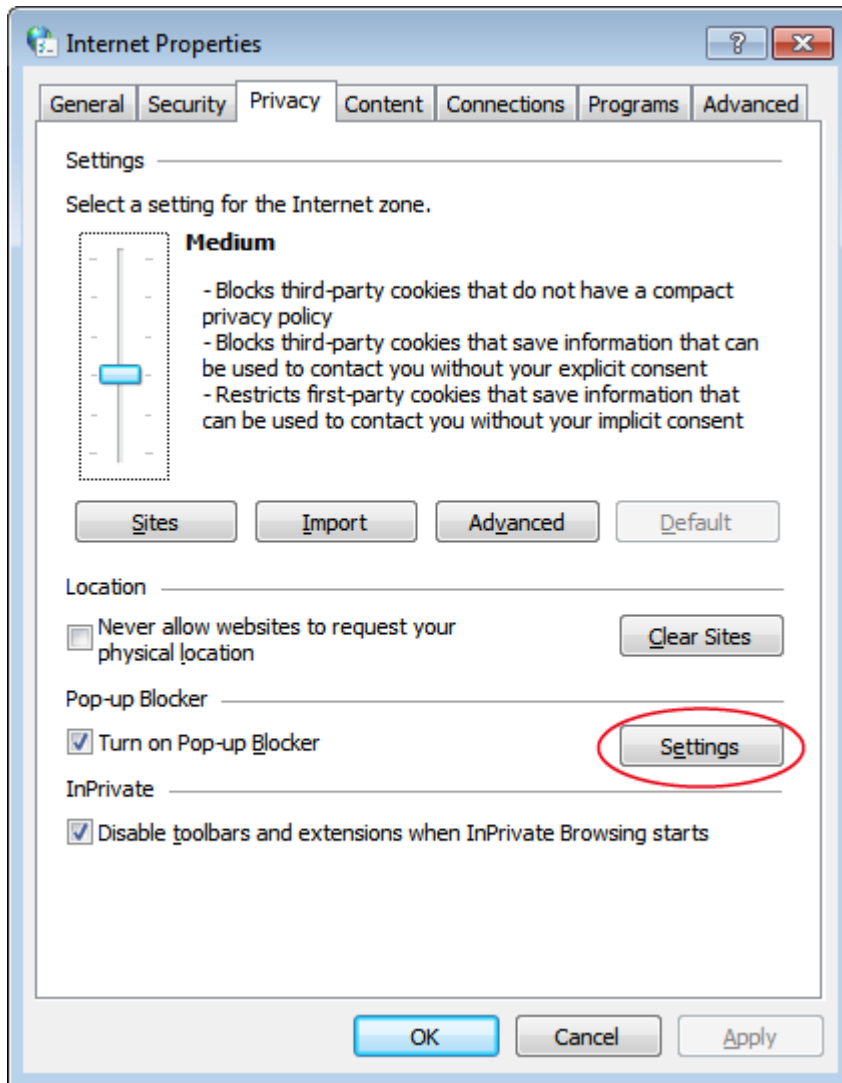

- 5 In the Pop-up Blocker Settings window, type "127.0.0.1" in the "Address of website to allow:" field, and click the [Add] button.

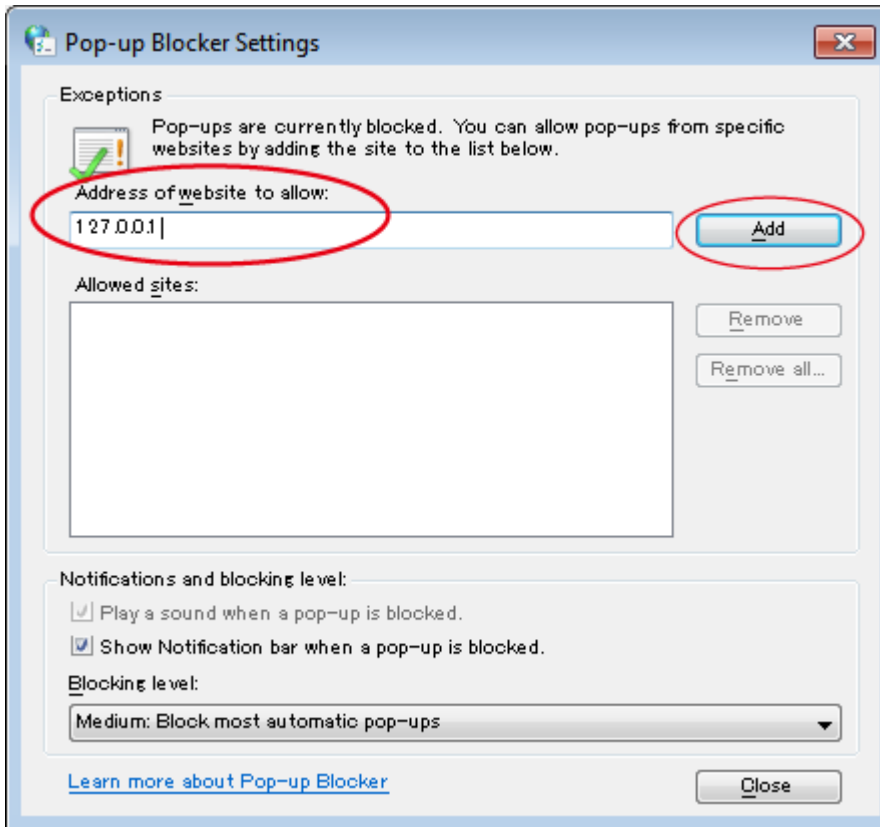

- 6 Check that "127.0.0.1" has been added to the "Allowed sites:" area, and click the [Close] button.



Hint

Close the Internet Properties window or the Network and Internet window if it is open.

Then, the Pop-up Blocker setting process is completed.

If "Yes" is selected for "Do you want to use SSL communication?" in step 14 on p.56, proceed to the next step - p.66, "4-4 Installing the server certificate", and if "No" is selected, proceed to p.86, "6-1 Setting shutdown parameters - Using Web server software -".

4-4 Installing the server certificate

- 1 Click the [Start] button, and select "Control Panel", then "Network and Internet".

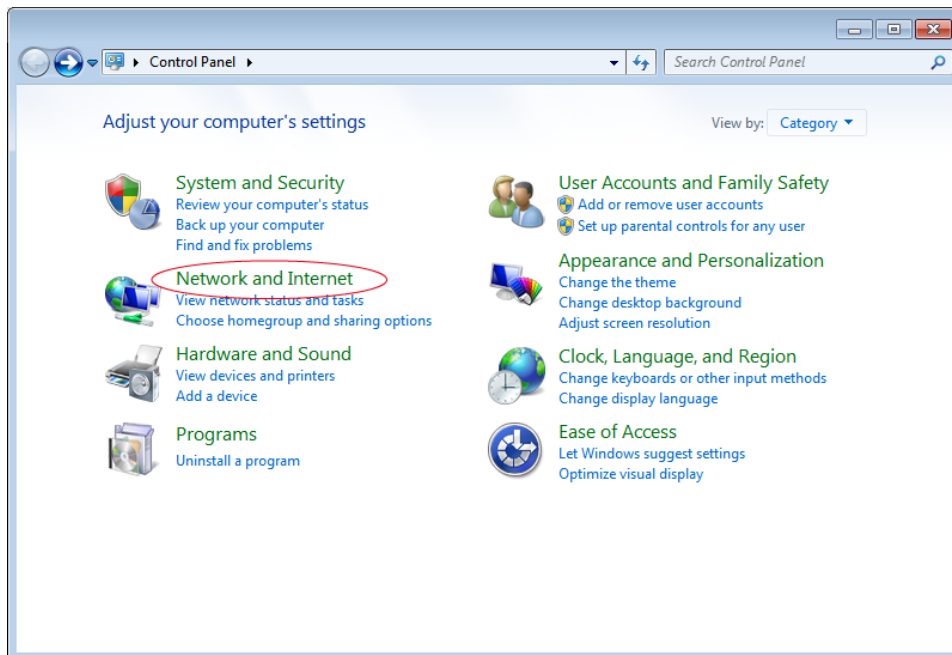

- 2 Select "Internet Options".

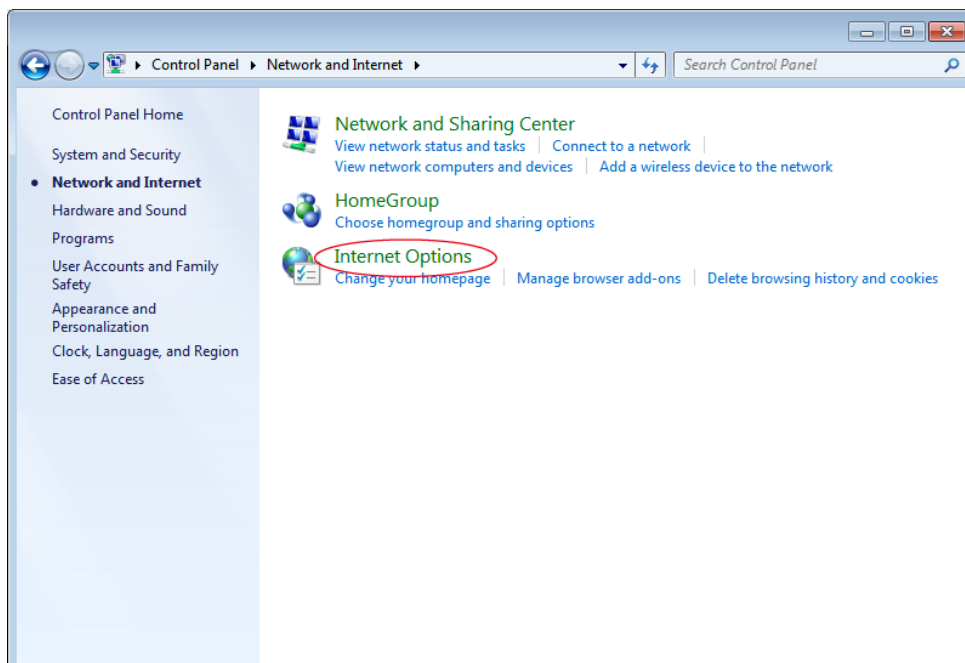

- 3 When the Internet Properties window appears, click the "Content" tab.

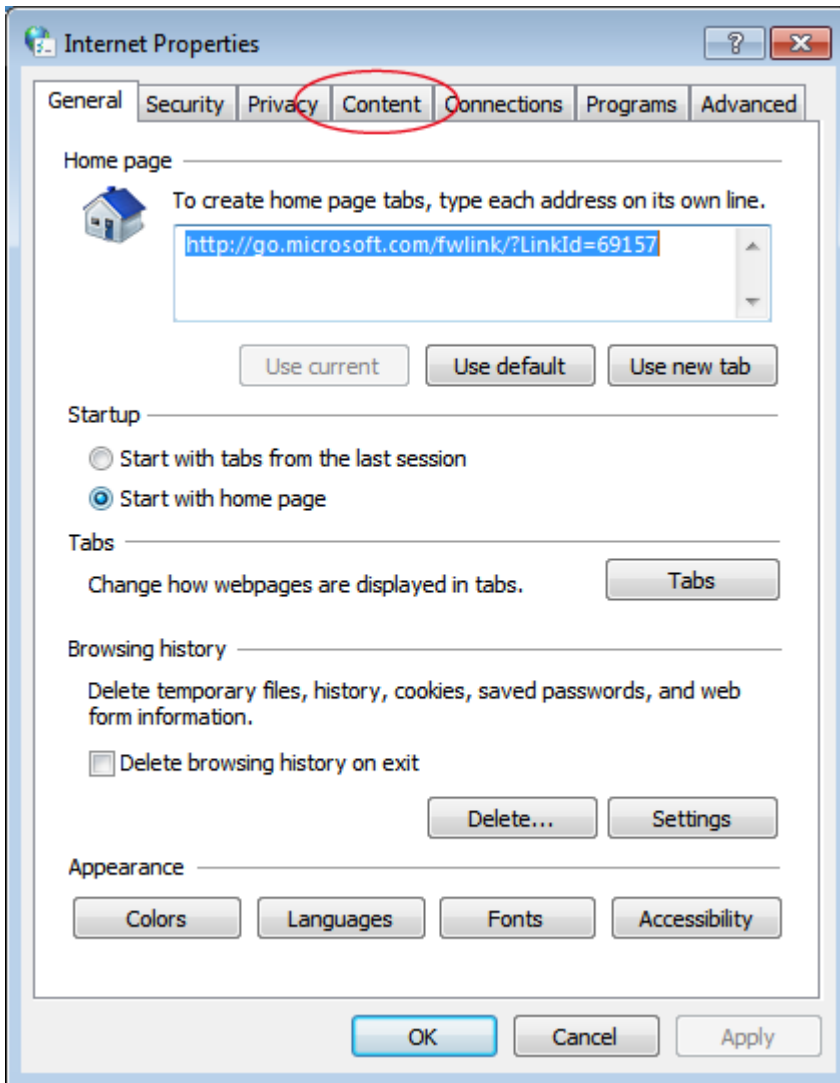

- 4 Click the [Certificates] button.

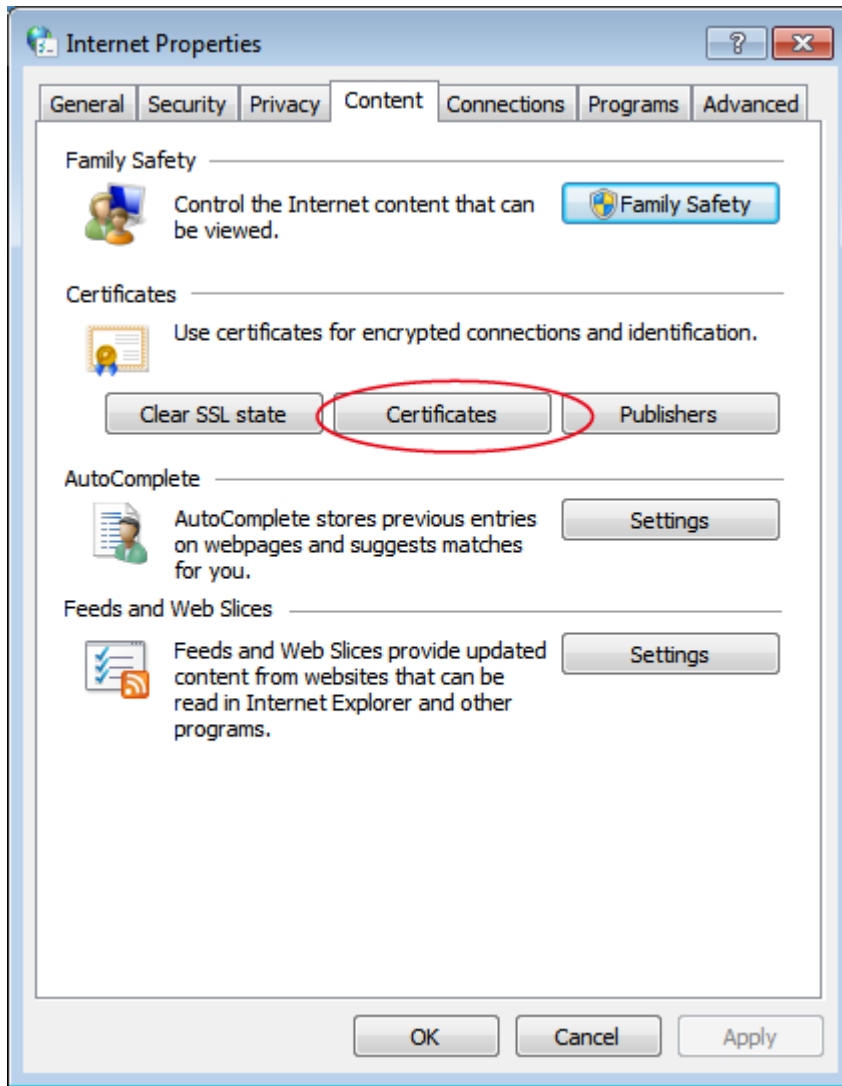

- 5 Select the "Trusted Root Certification Authorities" tab, and click the [Import...] button.

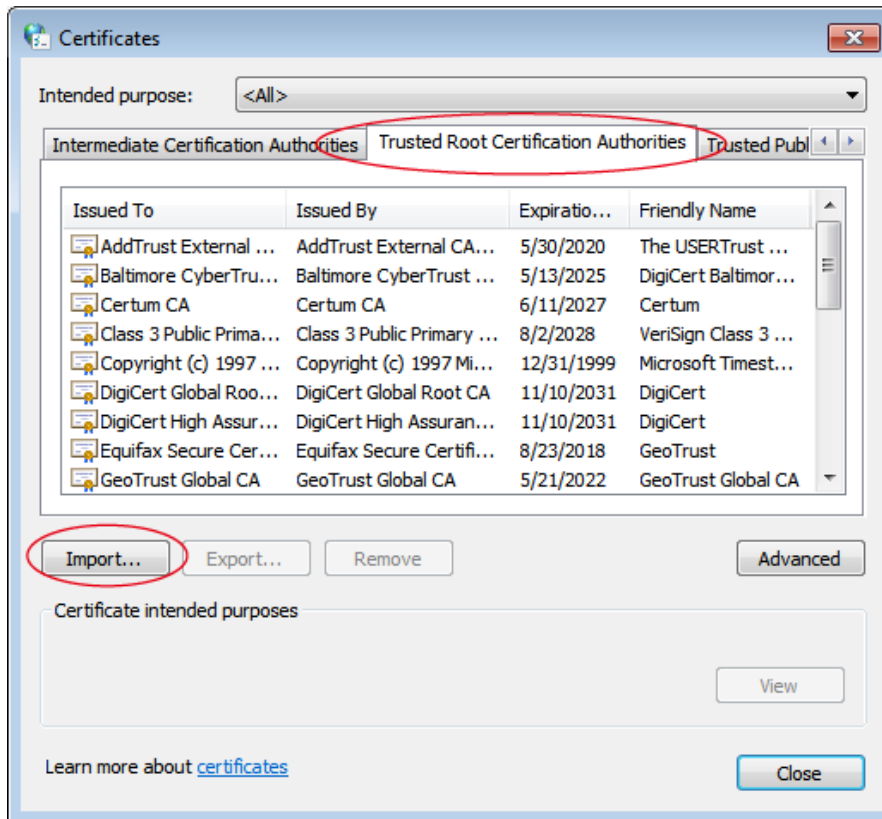

- 6 Click the [Next >] button.

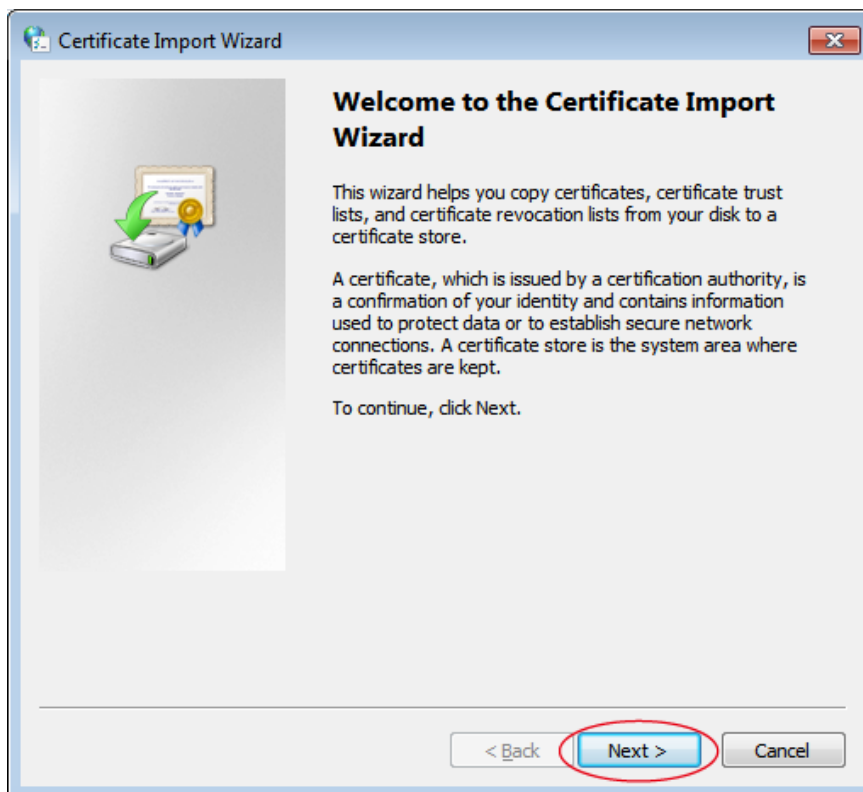

- 7 Click the [Browse...] button.

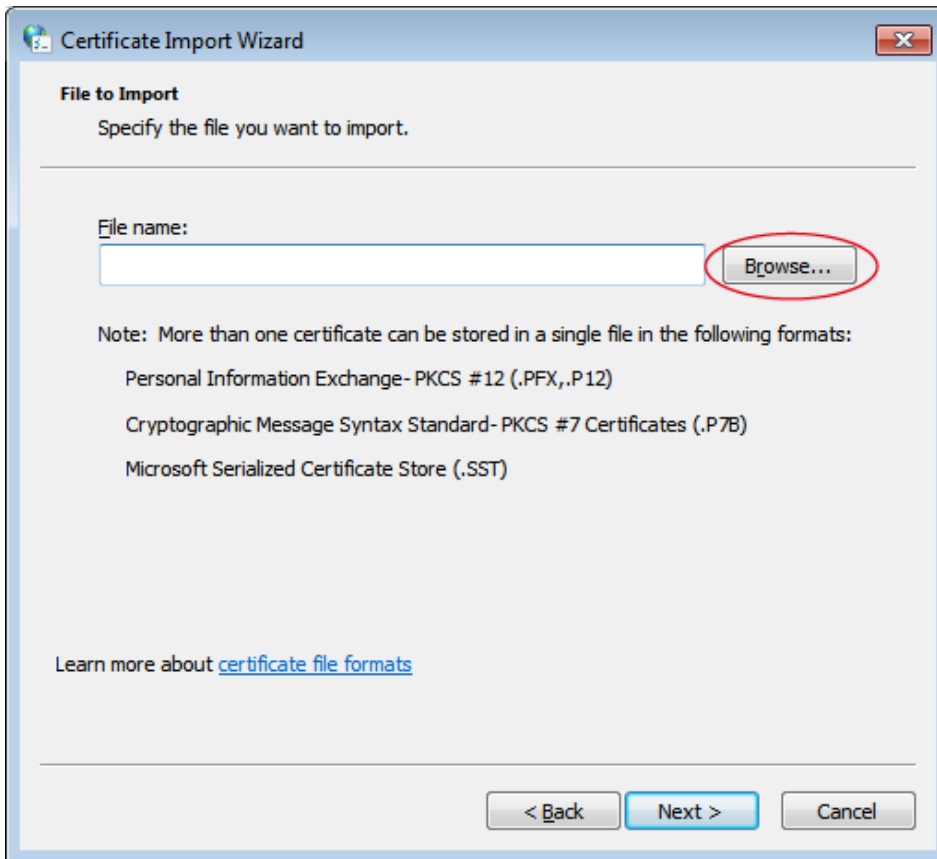

- 8 From [OS(C:)], select the [Program Files] or [Program Files(x86)] folder, the [PowerAct Pro(Master Agent)] folder, then "server.crt", and click the [Open] button.

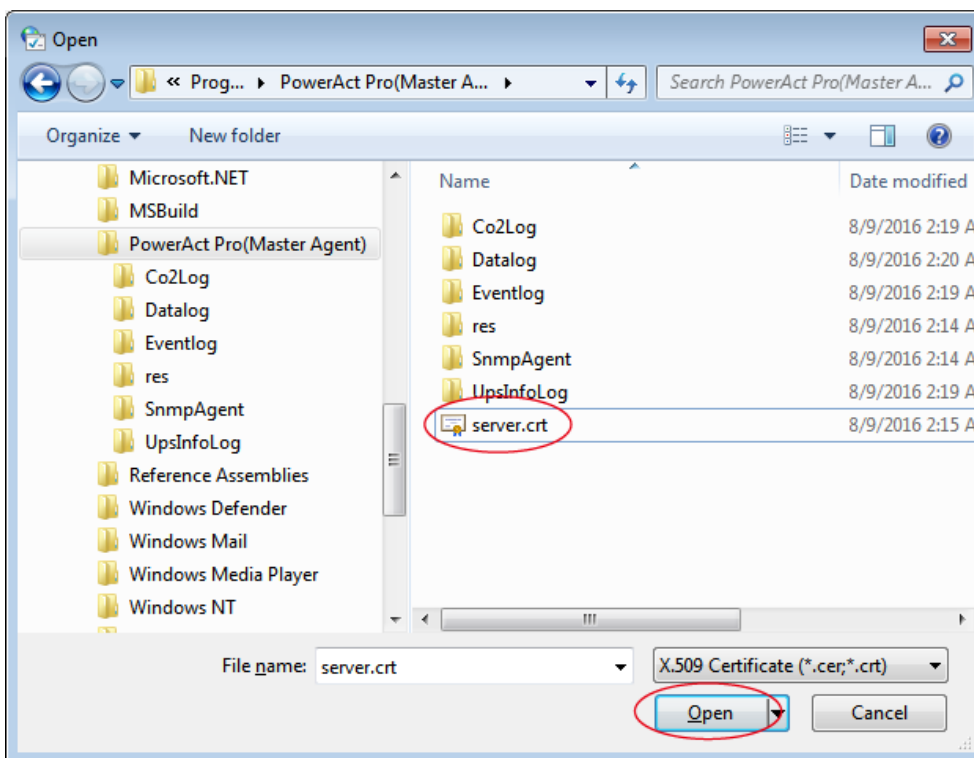

9 When the Certificate Import Wizard window appears again, click the [Next >] button.

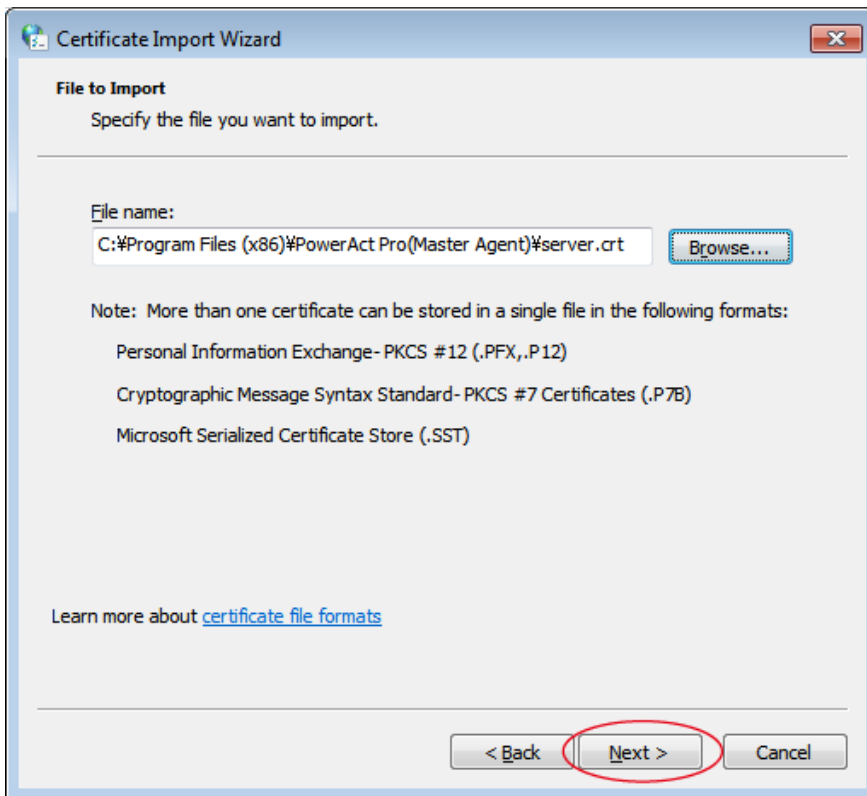

10 Click the [Next >] button.

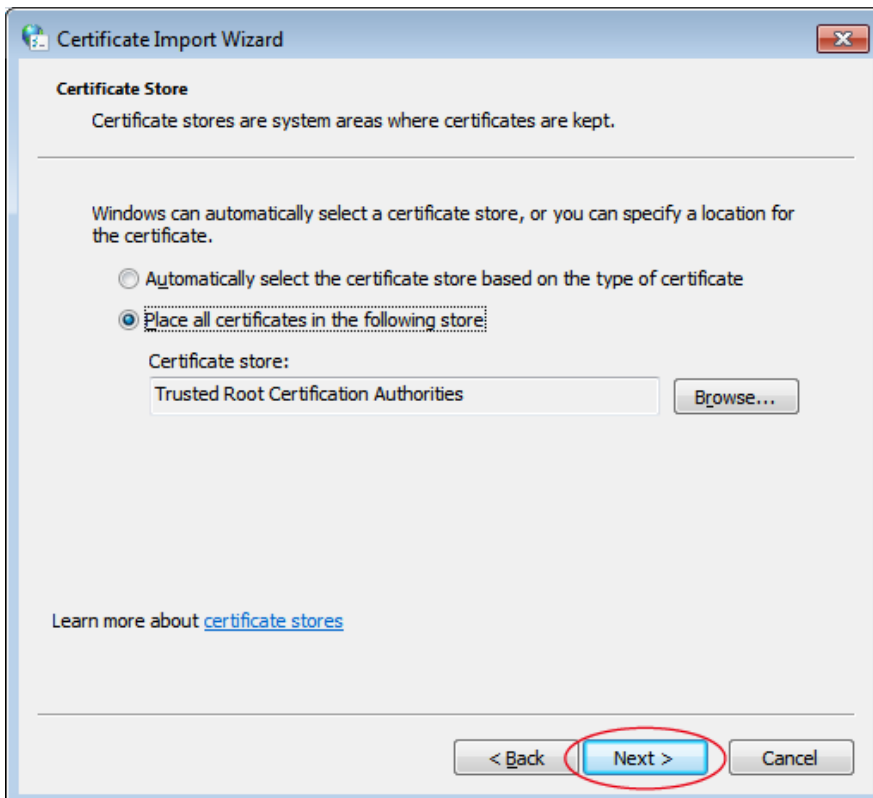

11 Click the [Finish] button.

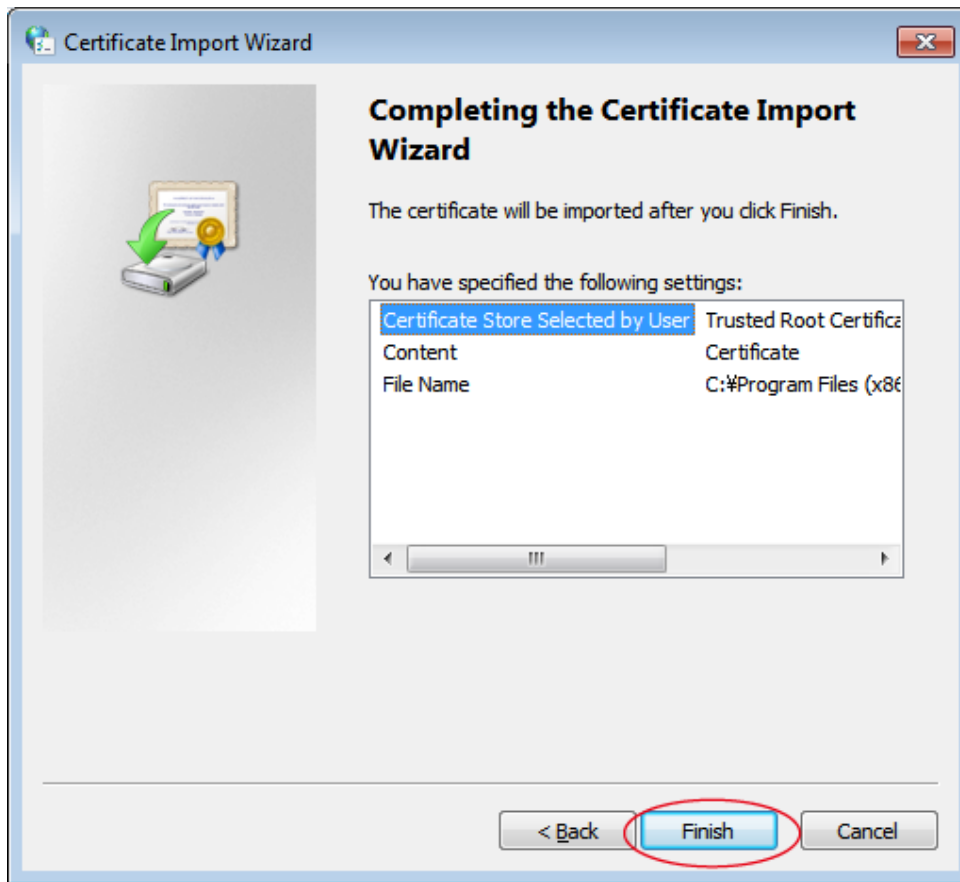

12 If a warning window appears, click the [Yes] button.

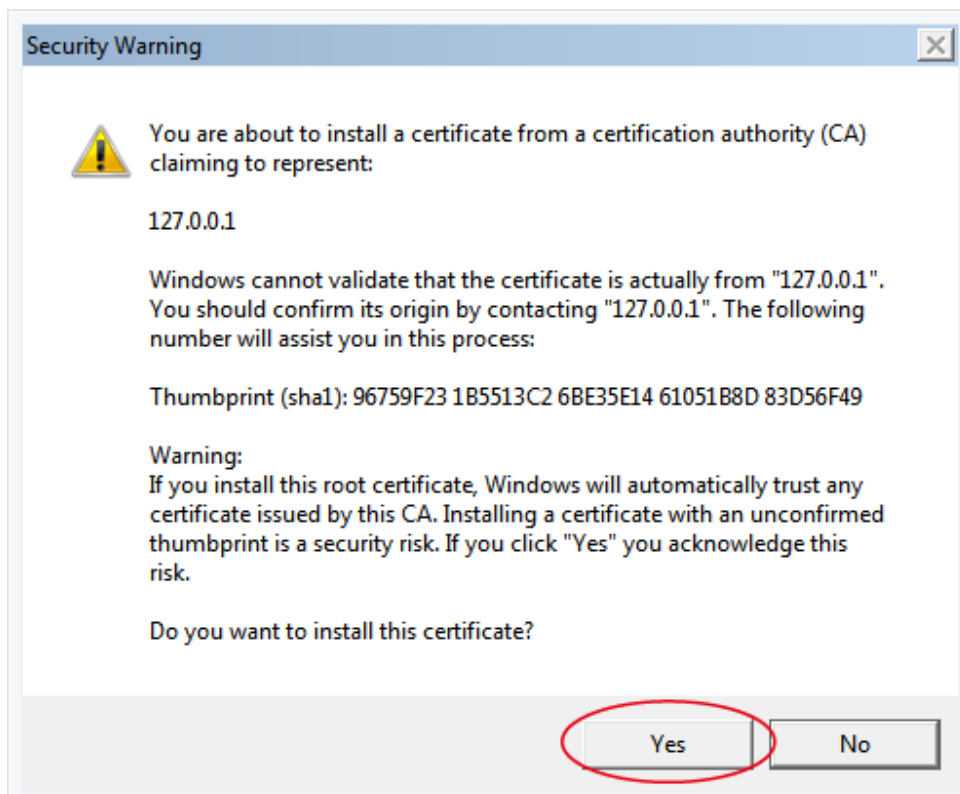

13 Click the [OK] button.

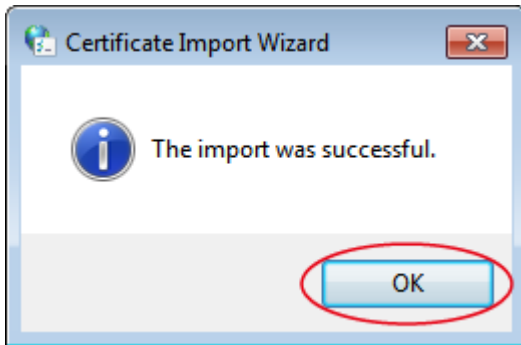

14 Click the [Close] button.

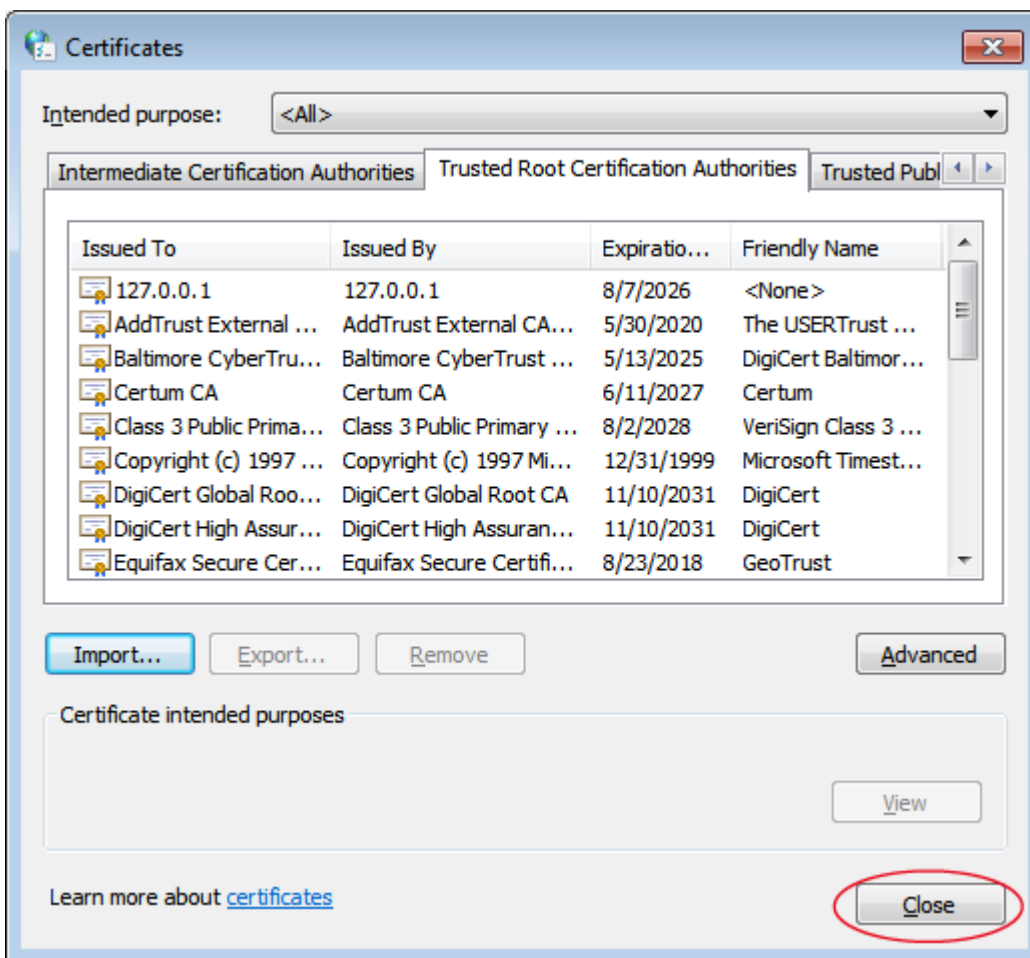

Hint

Close the Internet Properties window or the Network and Internet window if it is open.

The installation of the server certificate when using IIS is completed.

Then, proceed to p.86, "6-1 Setting shutdown parameters - Using Web server software -".

5 Installation Method - Not Using Web Server Software -

5-1 Installing the software

- 1 Please download the PowerAct Pro software from OMRON's Web site.

File name: PAPV***_Master_Windows.zip (Remark: *** is Number from 0 to 9 <Ex:515>)

- 2 Unzip the download file "PAPV***_Master_Winodws.zip".

Hint

If start unzip operation for "PAPV***_Master_Windows.zip", the "PAPV***_Master_Windows" folder create automatically.

- 3 Open the "PAPV515_Master_Windows" folder and then double click "Setup.exe".

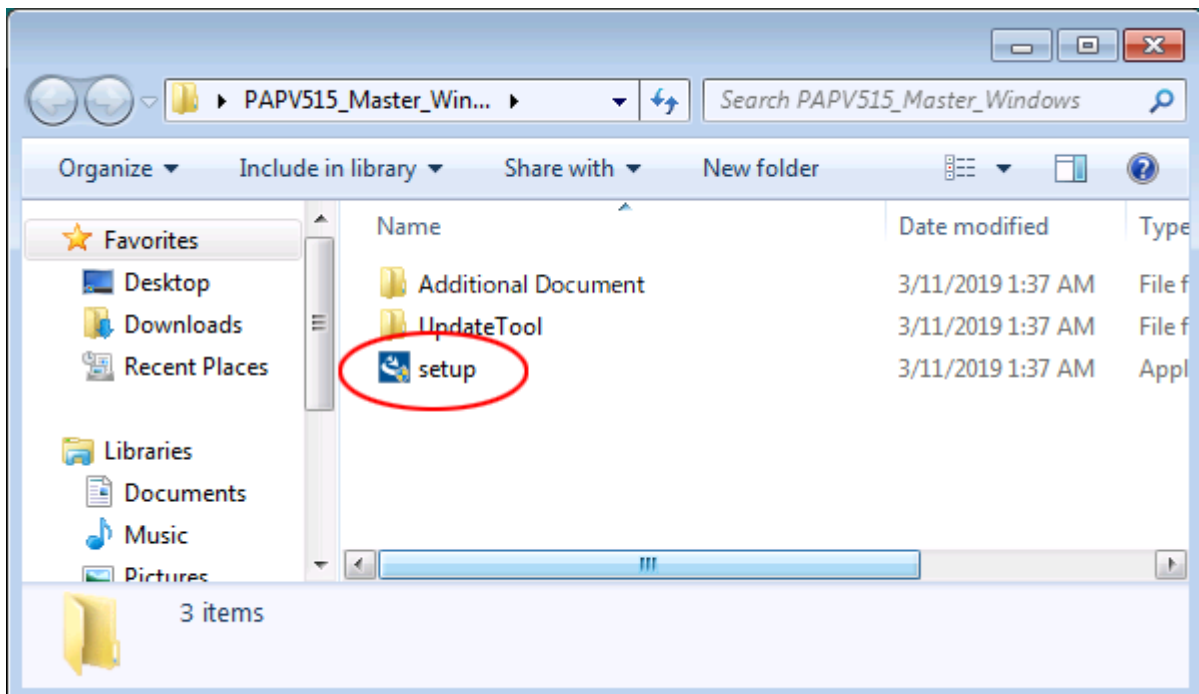

- 4 Click the [Yes] button.

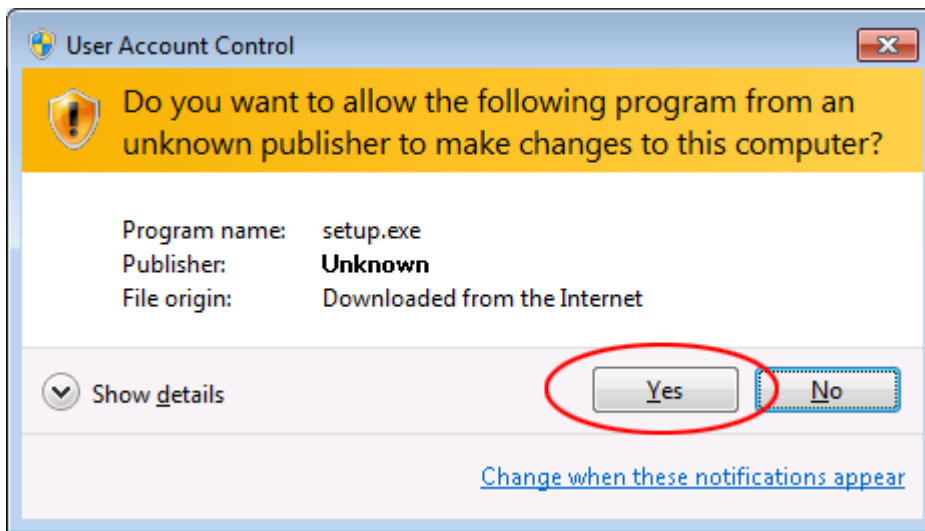

- 5 Click the [Next >] button.

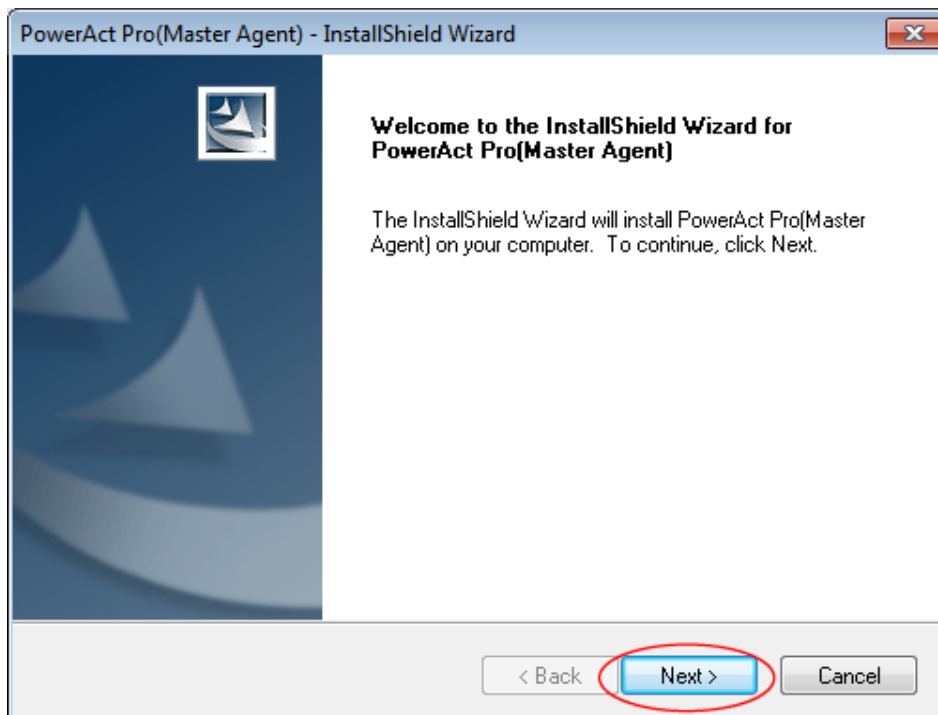

- 6 Read the contents of "License Agreement" carefully, select the radio button for "I accept the terms of the license agreement", and click the [Next >] button.

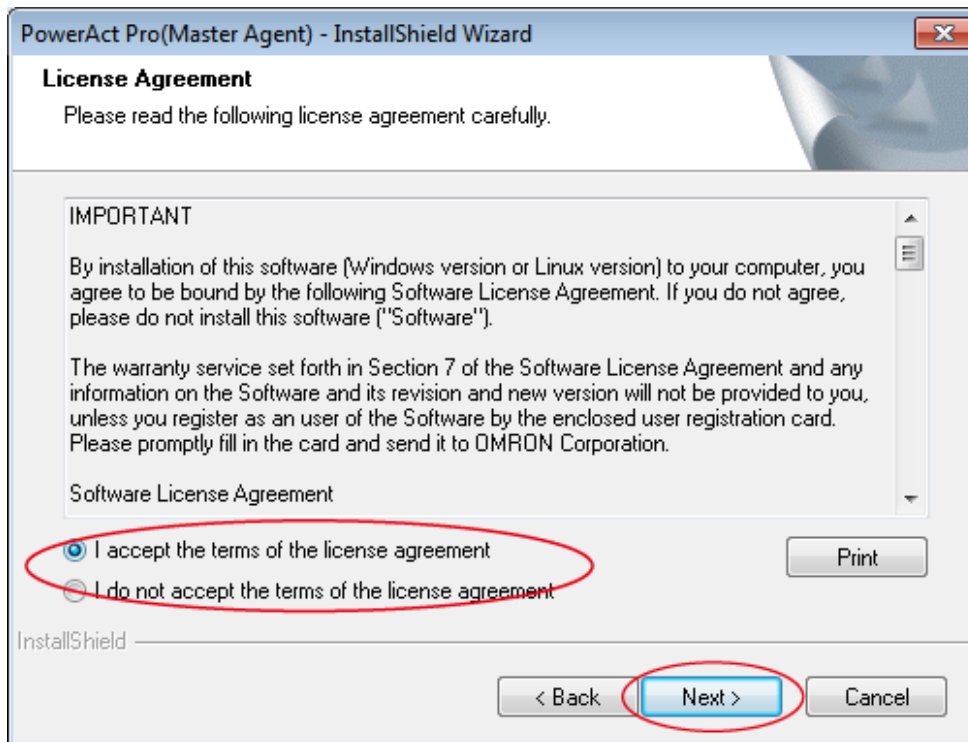

Hint

If you do not accept the terms of the license agreement, you can not use the software.
In that case, click the [Cancel] button to stop the installation process.

- 7 Select the radio button for "Standalone Install [Disable network function]", and click the [Next >] button.

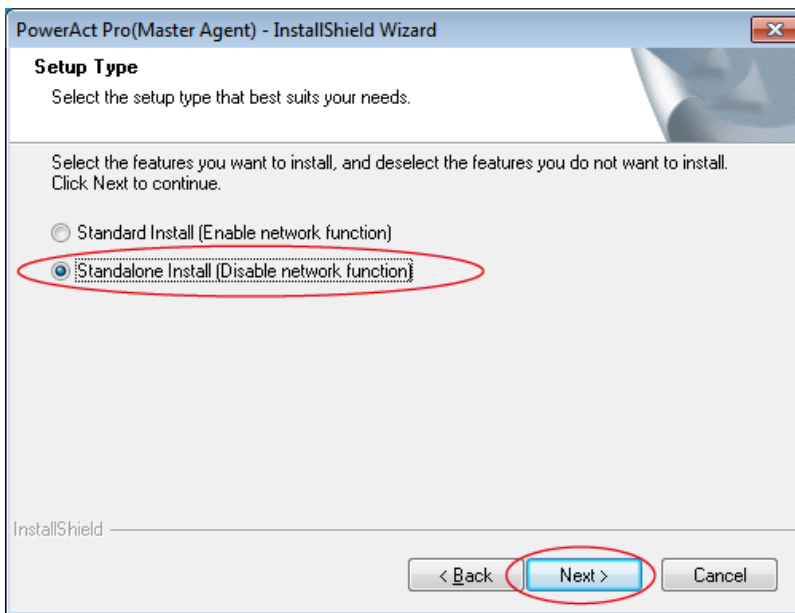

Hint

When "Standard Install" is selected, you can use the following via the network.

- Checking, setting, and controlling UPS information in the Web Monitor window of a computer on the network
- Shutting down a computer where Slave Agent is installed
- Shutdown warning using SNMP and notification of UPS operation information to specified computers

- 8 Select the radio button for "No use Web Server" and click the [Next >] button.

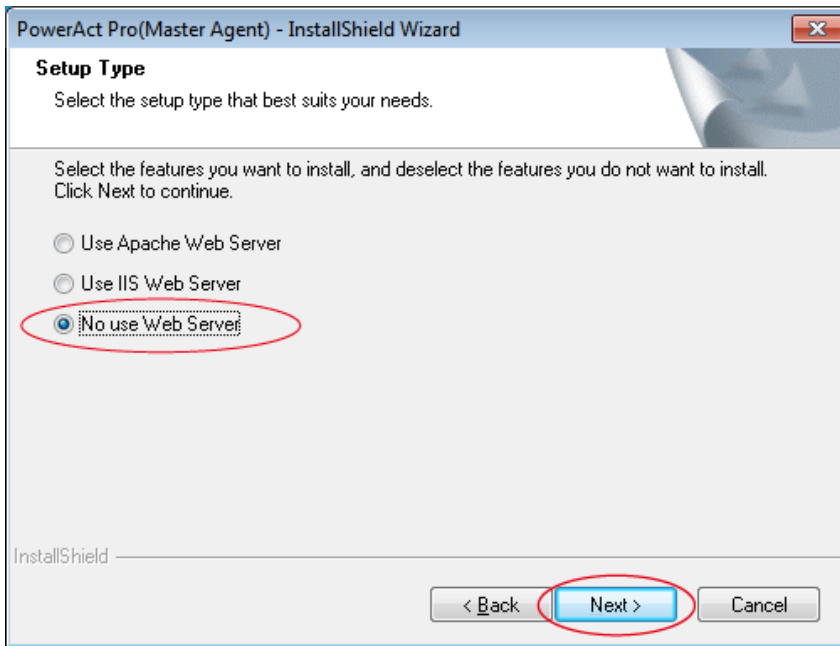

- 9 Click the [Next >] button.

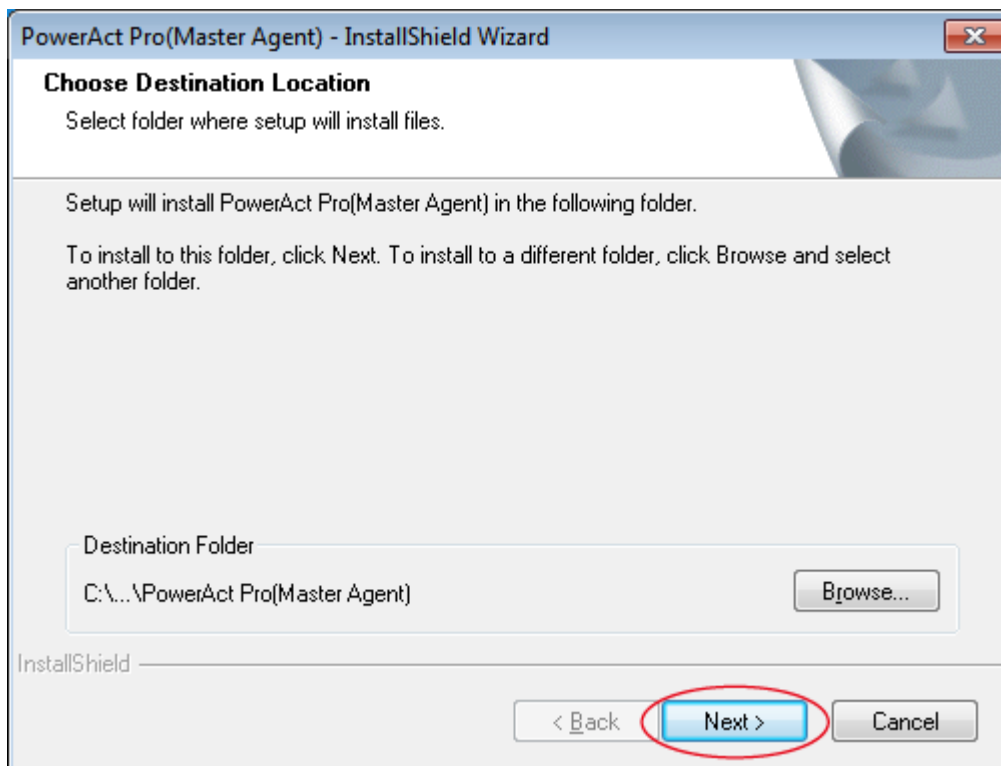
**CAUTION**

Do not install the software in a write-protected folder or network drive.
Be sure to install it in the read and write permitted hard disk drive in the local computer.

Hint

In this window, you can change the installation destination location for the software. To change the installation destination location for the software, click the [Browse...] button, specify the installation destination location, and click the [Next >] button.

10 Click the [Next >] button.

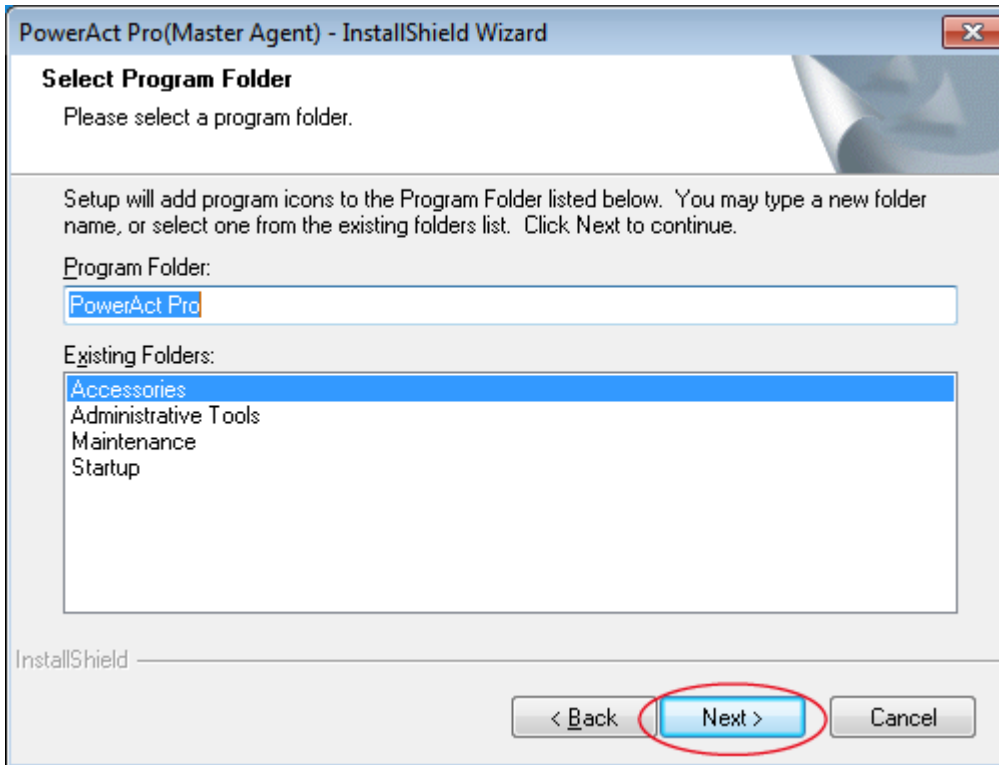

11 Click the [Next >] button.

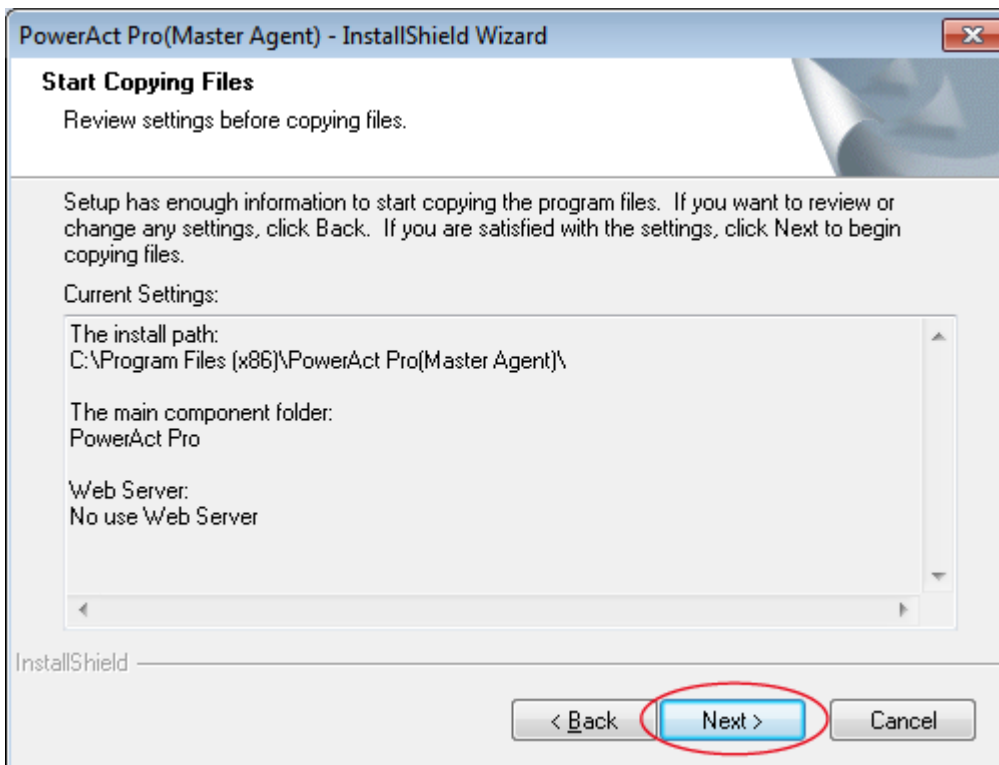

12 Select either "Auto" or "Manual", and click the [OK] button.

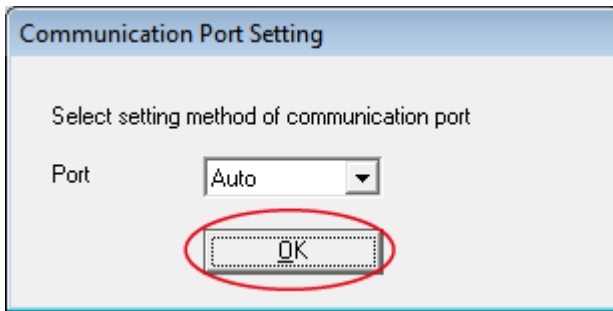

Hint

When "Auto" is selected, the COM ports, and then USB ports are searched to find the connected UPS. When "Manual" is selected, only the set COM port is searched (see p.126, "7-25 Selecting "Manual" in "Communication Port Setting").

13 Check the result and click the [OK] button.

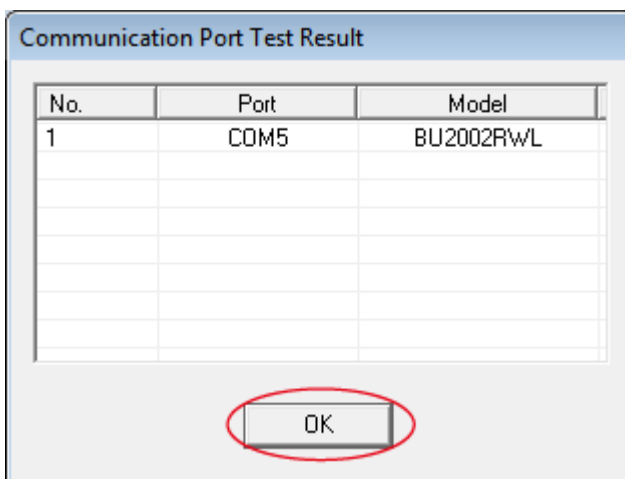

Hint

If no result is displayed for "Communication Port Test Result", communication between the software and the UPS is not established. However, there is no problem with the installation process itself, so click the [OK] button, and proceed to step 16. If you want your computer to communicate with the UPS at this point, see p.109, "7-2 Unable to communicate with the UPS".

Hint

If no result is displayed for "Communication Port Test Result" in step 14, neither the window in step 15 nor the window in step 16 is displayed.

- 14 Enter values for "UPS Start Date:", "Battery Use Date (Battery Change Date):", and "Next Battery Replace Date:", and click the [OK] button.

Battery Use Date (Battery Change Date) Setting

[Notice] The date input should be later than 2000-01-01.

UPS Start Date:

COM 5

Battery Use Date (Battery Change Date):

Next Batter Replace Date:

- 15 Click the [OK] button.

Battery Use Date (Battery Change Date) Setting Result

No.	Port	Battery Use Date
1	COM 5	2016-08-09

16 Click the [OK] button.

ConfigShutdownParameter

Shutdown Parameter | Boot/Reboot | Communication

Shutdown Parameter

Select UPS Outlet: Outlet A (No Control)

AC Fail Delay Time: 60 Sec

Shutdown Start Delay Time: 0 Sec

External Command Line:

Run External Command Executed Time: 0 Sec

Shutdown Need Time: 180 Sec

Select OS Shutdown Mode: Hibernate

Select Virtual Server Shutdown Mode: Shutdown by System

Select Guest OS Shutdown Mode: Shutdown

UPS Auto Stop: Enable

Other Device

Outlet A (No Control): 0 Sec

Outlet B (Control): 0 Sec

Outlet C (Control): 0 Sec

AC Fail Backup Time

Maximum backup time for AC fail: 0 Min

OK Cancel

Hint

You can also set the shutdown operation from the [Shutdown parameter setting] icon created on Desktop after the installation process is completed.

17 Specify the password in 1 to 15 single-byte alphanumeric characters (A to Z, a to z, 0 to 9).

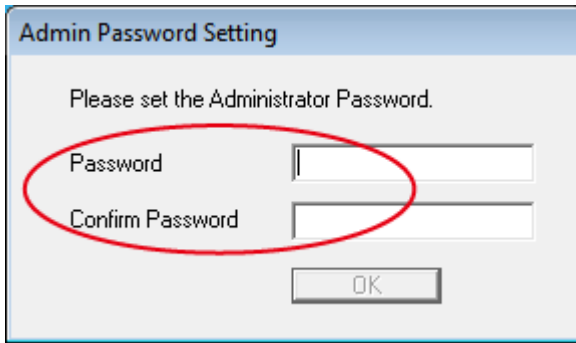

The image shows a dialog box titled "Admin Password Setting". It contains the instruction "Please set the Administrator Password." Below this, there are two text input fields: "Password" and "Confirm Password". Both fields are currently empty. A red oval highlights both input fields. At the bottom of the dialog, there is an "OK" button.

CAUTION

Note that a password value is case-sensitive.

CAUTION

Be sure to keep the set password by taking a note of it, and so on.

Hint

This password is used when logging in to PowerAct Pro Monitor (see step 4 on "p.87, "6-1 Setting shutdown parameters - Using Web server software -").

18 Click the [OK] button.

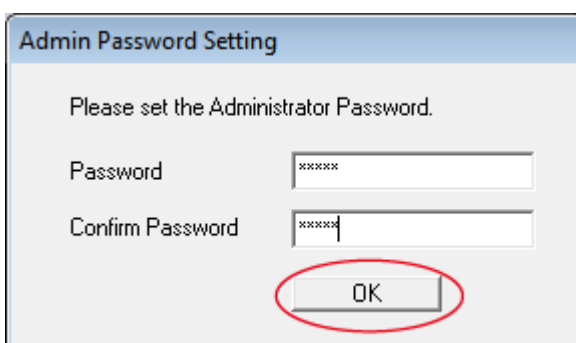

The image shows the same "Admin Password Setting" dialog box as in the previous step. The "Password" and "Confirm Password" fields now contain six asterisks (*****). A red oval highlights the "OK" button at the bottom of the dialog.

19 Click the [Finish] button to return to the Desktop window.

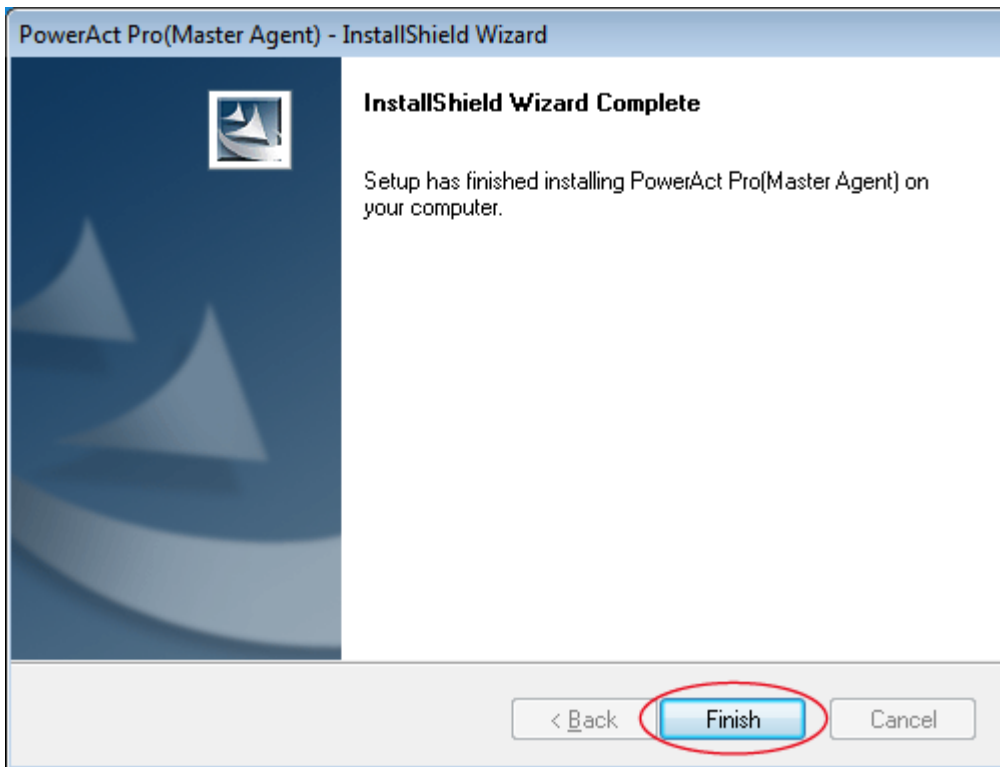

Hint

Close the "PAPV***_Master_Windows" folder if it is open.

The installation of the software without using Web server software is completed.

Then, proceed to p.92, "6-2 Setting shutdown parameters - Not using Web server software -".

6 Shutdown Operation Check

6-1 Setting shutdown parameters - Using Web server software -

- 1 Double-click the [PowerAct Pro Monitor] icon on Desktop.



- 2 Click the [Yes] button.

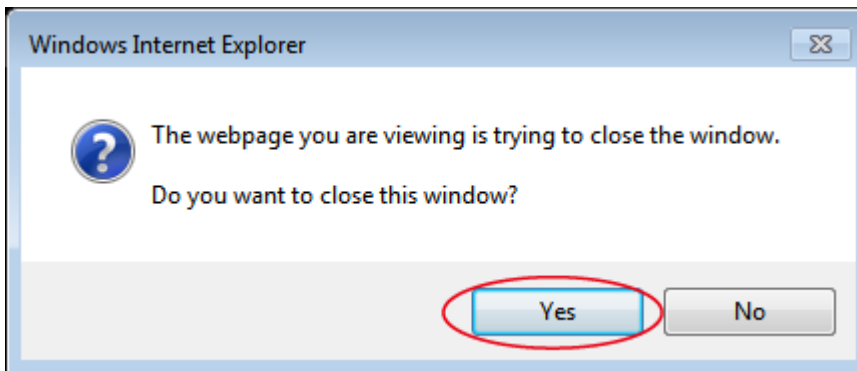

- 3 Click the name of server in which the software is installed.

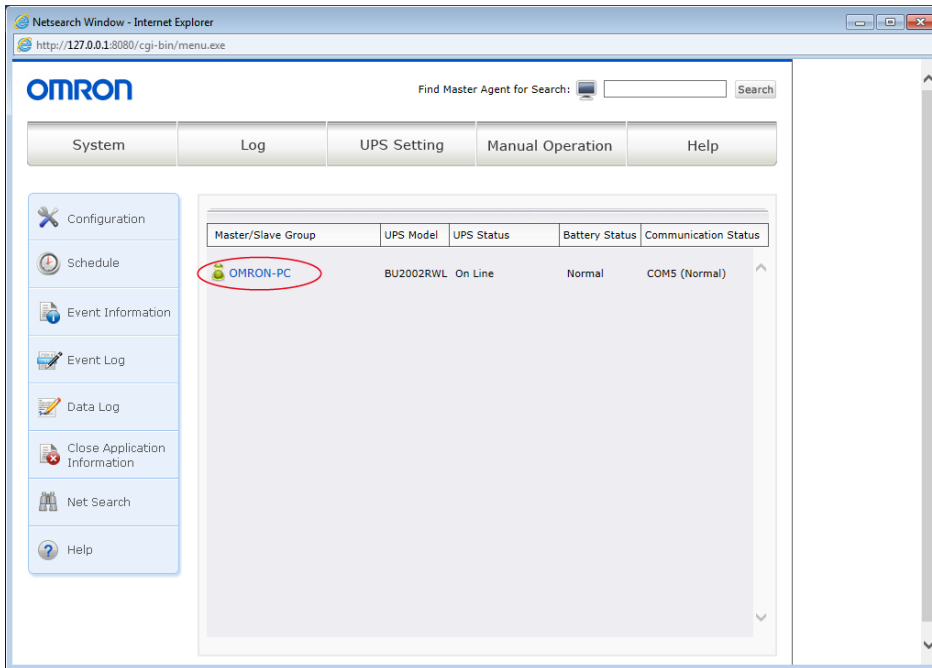

- 4 For "User ID", enter "Admin", and for "Password", enter the password set when the software was installed, and click the [OK] button.

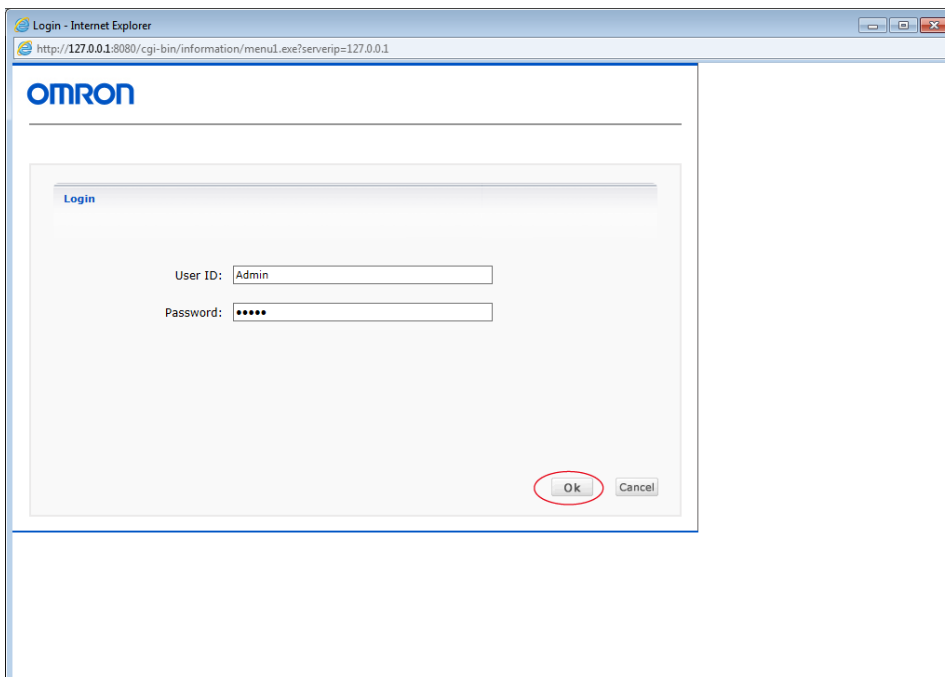

CAUTION

Be sure to enter "A" in "Admin" in uppercase.
Note that a password value is case-sensitive.

5 Click [Configuration].

The screenshot shows the Power Act Pro Monitor OMRON-PC web interface. The browser title is "Power Act Pro Monitor OMRON-PC (Full Access) - Internet Explorer" and the URL is "http://127.0.0.1:8080/cgi-bin/information/firstpage.exe". The interface includes a search bar, navigation tabs (System, Log, UPS Setting, Manual Operation, Help), and a left sidebar with menu items: Configuration (circled in red), Schedule, Event Information, Event Log, Data Log, Close Application Information, Net Search, and Help. The main content area displays system information:

Date and Time: 2016-08-09 05:33:59 Next Battery Replace Date: 2017-08-09
 Battery Use Date (Battery Changed Date): 2016-08-09

UPS Model: BU2002RWL Buzzer Status: Off
 UPS Status: On Line Function Test Status: On
 Outlet A(No Control): Output Start Battery Auto Test: On
 Outlet B(Control): NoSupport UPS cold start status: NoSupport
 Outlet C(Control): NoSupport Input/Output Setting: 200V/Standard
 Battery Status: Normal UPS Auto Reboot: On

Additional Battery Units: Communication Port: COM 5 Submit
 Test Result:

Input Voltage:	80	120	160	200	240	280	236.7 V
Output Voltage:	80	120	160	200	240	280	199.6 V
Input Frequency:	40	45	50	55	60	65	49.9 Hz
Output Frequency:	40	45	50	55	60	65	49.9 Hz
Load Level:	0	25	50	75	100	125	0 %
Battery Capacity:	0	25	50	75	100	125	100 %

Hint

If no result is displayed for "UPS Model:", communication between the software and the UPS is not established. See p.109, "7-2 Unable to communicate with the UPS".

6 Change settings.

Set the basic setting items related to the shutdown operation in the event of an input power supply abnormality (power failure, voltage fluctuations, etc.) such as "AC Fail Delay Time", "Shutdown Need Time", and "UPS Auto Stop".

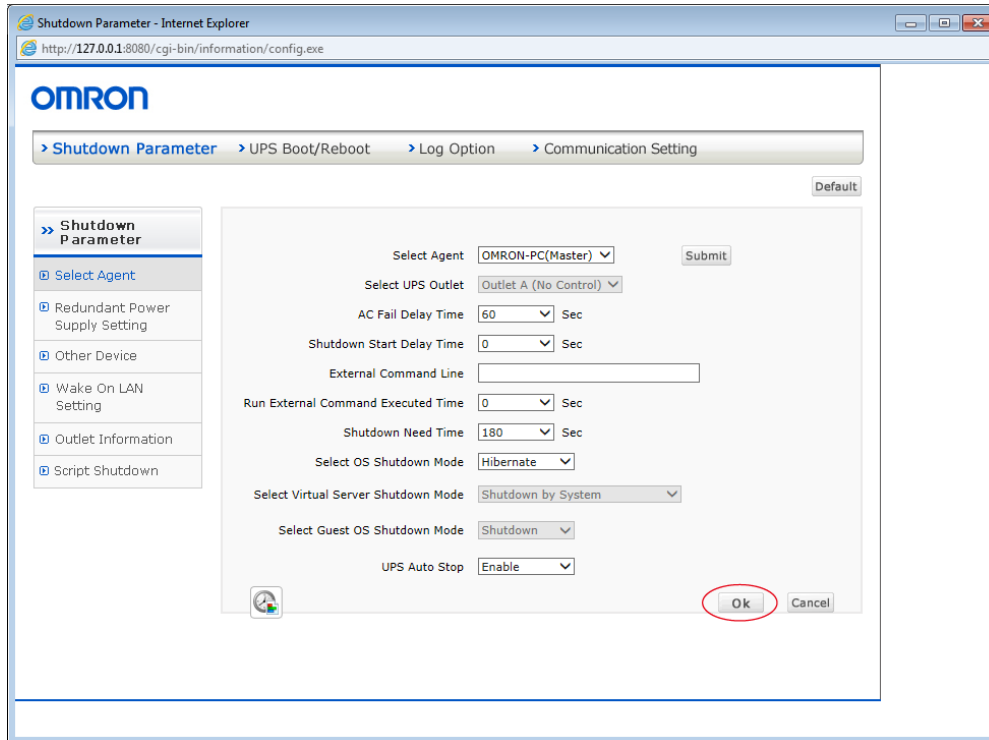

Item	Description
AC Fail Delay Time	<p>Set the delay time from when the software detects an input power supply abnormality until shutdown operation starts.</p> <p>Default value: 60 seconds</p> <p>* When power supply recovery is detected within the AC Fail Delay Time, shutdown operation is not started. If 0 second is set, shutdown operation starts immediately after an input power supply abnormality is detected. So, set a sufficient length of time.</p>
Shutdown Need Time	<p>Set the length of time from when the OS starts shutdown operation until the UPS automatically stops.</p> <p>Default value: 180 seconds</p> <p>* Set a sufficient length of time to prevent the UPS from stopping outputting power while the OS is shutting down.</p>

Item	Description
UPS Auto Stop	Set whether to automatically stop the UPS for shutdown when an input power supply abnormality occurs. Default value: Stop
	Stop: The UPS stops its output after the period of time set for [Shutdown Need Time]. Set this in order to prevent unnecessary battery discharge (to save battery life) when a power failure lasts for a long time.
	Not stop: The value set for [Shutdown Need Time] is disabled. The UPS continues to discharge until its battery life ends, and stops its output when the battery is dead.

7 Set any of the following items as needed.

Item	Description
Shutdown Start Delay Time	Set this item in an environment in which multiple computers are connected to the UPS and if you want to delay the start of shutdown operation of one computer in relation to other computers. Setting range: 0 to 600 seconds (settable in 60-second steps) Default value: 0 second
External Command Line	Enter a command for the program to be executed at shutdown. Set the program execution time in "Run External Command Executed Time" shown below. * The "program to be executed" refers to a program for such operation as saving data.
Run External Command Executed Time	Set the time necessary for executing the program set for "External Command Line". During program execution, the OS shutdown operation is temporarily stopped. Setting range: 0 to 600 seconds (settable in 60-second steps) Default value: 0 second * When using the Hyper-V function, to shut down the virtual server with this software, set the time necessary for shutting down the Guest OS (virtual server OS) here.
OS Shutdown Mode	For the OS shutdown mode, select between [Shutdown] and [Hibernate].
Select Guest OS Shutdown Mode	When [Shutdown by PowerAct Pro] is selected for "Select Virtual Server Shutdown Mode", select the Guest OS shutdown mode between [Shutdown] and [Hibernate].

8 Click the [OK] button to update the settings.

If you do not change the settings, click the [Cancel] button.

The shutdown parameter setting process using Web server software is completed.

Then, proceed to p.97, "6-3 Shutdown test".

6-2 Setting shutdown parameters - Not using Web server software -

- 1 Right-click the PowerAct Pro resident-program icon in the task tray, and select [Agent Stop].

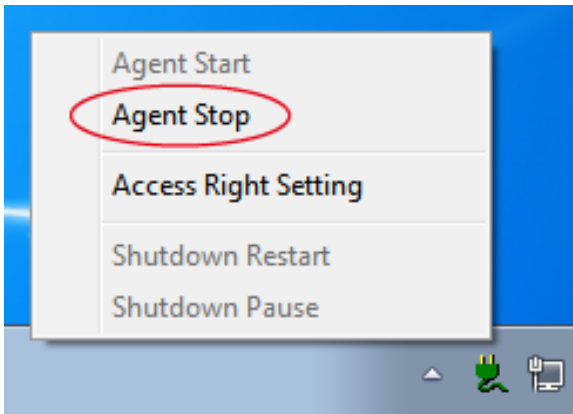

- 2 The Agent program stops and a red cross mark "x" appears on the icon.



- 3 Double-click [ConfigShutdownParameter] on Desktop.

**CAUTION**

To change settings using [ConfigShutdownParameter], be sure to stop the Agent program.

Hint

You can open the ConfigShutdownParameter window also by selecting the [Start] button, [Programs], [PowerAct Pro], then [ConfigShutdownParameter].

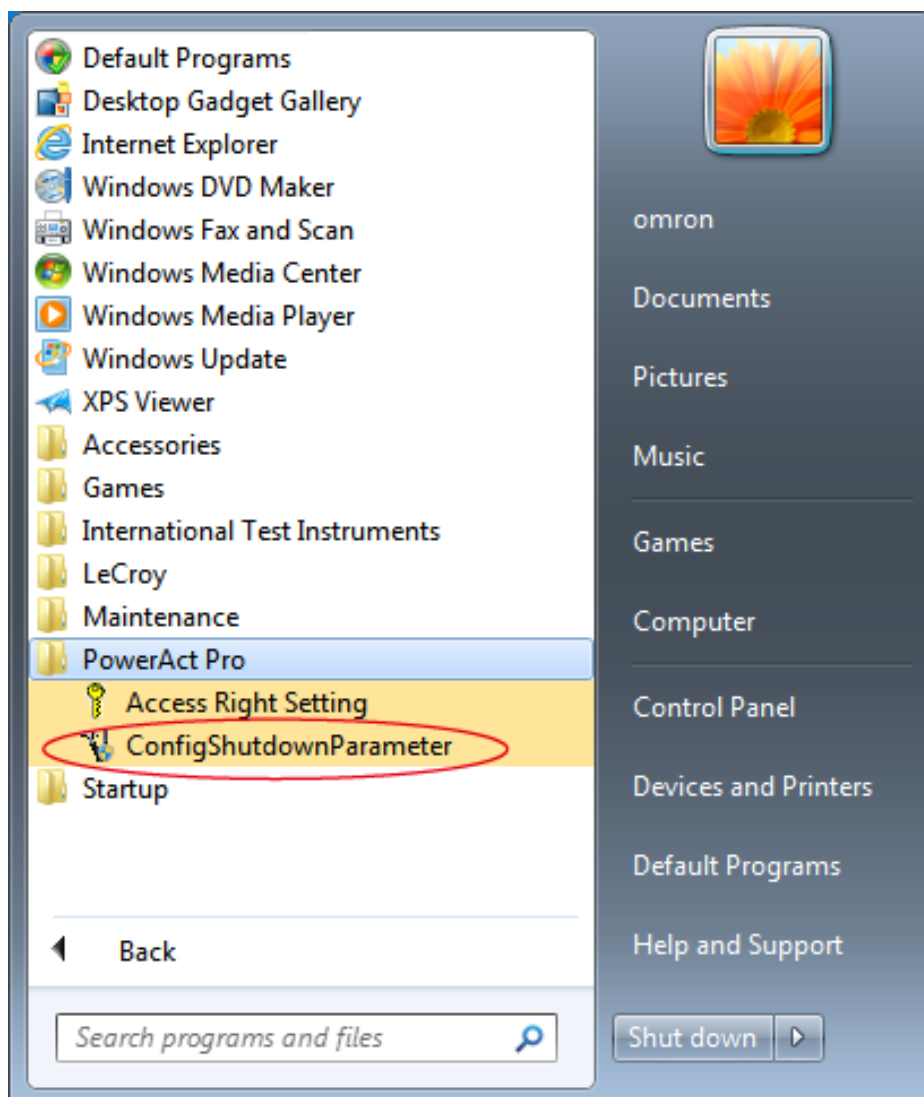

4 Change settings.

Set the basic setting items related to the shutdown operation in the event of an input power supply abnormality (power failure, voltage fluctuations, etc.) such as "AC Fail Delay Time", "Shutdown Need Time", and "UPS Auto Stop".

Item	Description
AC Fail Delay Time	<p>Set the delay time from when the software detects an input power supply abnormality until shutdown operation starts.</p> <p>Default value: 60 seconds</p> <p>* When power supply recovery is detected within the AC Fail Delay Time, shutdown operation is not started. If 0 second is set, shutdown operation starts immediately after an input power supply abnormality is detected. So, set a sufficient length of time.</p>

Item	Description
Shutdown Need Time	<p>Set the length of time from when the OS starts shutdown operation until the UPS automatically stops.</p> <p>Default value: 180 seconds</p> <p>* Set a sufficient length of time to prevent the UPS from stopping outputting power while the OS is shutting down.</p>
UPS Auto Stop	<p>Set whether to automatically stop the UPS for shutdown when an input power supply abnormality occurs.</p> <p>Default value: Stop</p>
	<p>Stop:</p> <p>The UPS stops its output after the period of time set for [Shutdown Need Time].</p> <p>Set this in order to prevent unnecessary battery discharge (to save battery life) when a power failure lasts for a long time.</p>
	<p>Not stop:</p> <p>The value set for [Shutdown Need Time] is disabled.</p> <p>The UPS continues to discharge until its battery life ends, and stops its output when the battery is dead.</p>

5 Set any of the following items as needed.

Item	Description
Shutdown Start Delay Time	<p>Set this item in an environment in which multiple computers are connected to the UPS and if you want to delay the start of shutdown operation of one computer in relation to other computers.</p> <p>Setting range: 0 to 600 seconds (settable in 60-second steps)</p> <p>Default value: 0 second</p>
External Command Line	<p>Enter a command for the program to be executed at shutdown.</p> <p>Set the program execution time in "Run External Command Executed Time" shown below.</p> <p>* The "program to be executed" refers to a program for such operation as saving data.</p>
Run External Command Executed Time	<p>Set the time necessary for executing the program set for "External Command Line". During program execution, the OS shutdown operation is temporarily stopped.</p> <p>Setting range: 0 to 600 seconds (settable in 60-second steps)</p> <p>Default value: 0 second</p> <p>* When using the Hyper-V function, to shut down the virtual server with this software, set the time necessary for shutting down the Guest OS (virtual server OS) here.</p>
OS Shutdown Mode	<p>For the OS shutdown mode, select between [Shutdown] and</p>

Item	Description
	[Hibernate].
Select Guest OS Shutdown Mode	When [Shutdown by PowerAct Pro] is selected for "Select Virtual Server Shutdown Mode", select the Guest OS shutdown mode between [Shutdown] and [Hibernate].

6 Click the [OK] button to update the settings.

If you do not change the settings, click the [Cancel] button to close the window.

7 Right-click the PowerAct Pro resident-program icon in the task tray, and select [Agent Start].

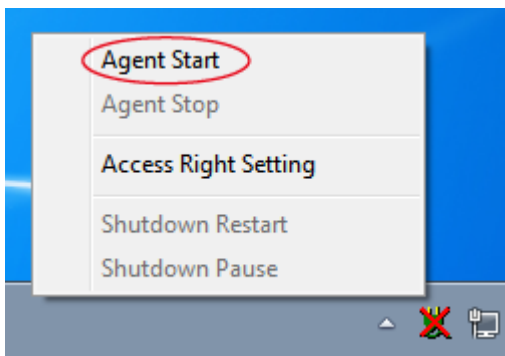

8 The Agent program starts and the red cross mark "x" disappears.



The shutdown parameter setting process without using Web server software is completed.

Then, proceed to p.97, "6-3 Shutdown test".

6-3 Shutdown test

Pull out the AC input plug, create a state similar to a power failure, and conduct a shutdown test.

Check the following behaviors.



- The computer shuts down.
- After the computer shuts down completely, the UPS stops outputting power.

Hint

For details on images of the above behaviors, see p.128, "Appendix-1 Shutdown operation sequence".

- 1 Check that the PowerAct Pro resident-program icon changed to... 

The PowerAct Pro resident-program icon indicates the following conditions.

Icon	Condition	Remarks
	During commercial operation	Communication between the UPS and the software is established. There is no problem with the input power supply.
	Communication error	Communication between the software and the UPS is not established. In this state, even if a power failure occurs, the UPS cannot be shut down. Check that the communication cable is connected securely. See p.109, "7-2 Unable to communicate with the UPS".
	Input power supply abnormality	The UPS is in backup operation (battery output) due to an input power supply abnormality. The cause of the above abnormality may be a power failure or frequency fluctuations.

- 2 Pull out the AC input plug of the UPS from the outlet to create a state similar to a power failure.

Hint

When a power failure occurs, the UPS status is indicated with  flashing. And the buzzer sounds every four seconds. For the status indication in LCD-display built-in UPS models, see the instruction manual for each model.

- 3 When the software detects a power failure, the PowerAct Pro resident-program icon changes to  .

- 4 After approximately 60 seconds (a value set for "AC Fail Delay Time"), start shutting down the OS.

- 5 Approximately 180 seconds after the start of OS shutdown operation (a value set for "Shutdown Need Time"), the UPS stops outputting power.

CAUTION

When "Not stop" is selected in the shutdown parameter settings, the output does not stop until the battery has been discharged completely.

Hint

When the output stops, the UPS status indication changes to (when the UPS stops completely, the status indication turns off). For the status indication in LCD-display built-in UPS models, see the instruction manual for each model.

- 6 Insert the AC input plug of the UPS into the outlet to restore power.

Hint

After power recovery, the UPS automatically starts (the UPS powers on).

Then, the shutdown test is completed.

7 Troubleshooting

7-1 When the "Check http port" warning appears

After step 23 on p.28, "3-1 Installing the software", the "Check http port" warning window may appear.

This means that the HTTP port to be used by Apache is being used by another program. Change the HTTP port number to be used by Apache.

7-1-1 Changing the port number while installing the software

- 1 Click the [OK] button to close the warning window.

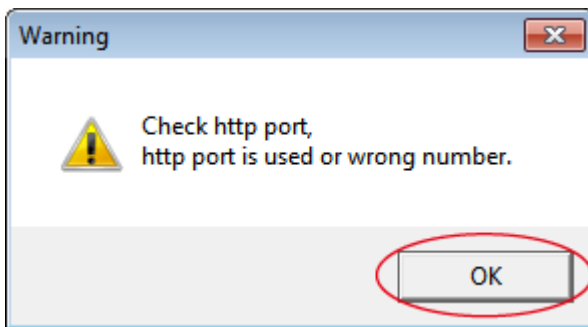

- 2 Click the [Communication] tab, change "80" in the "HTTP Port" field ("8080" in this example), and click the [OK] button (HTTP port number default value: 80).

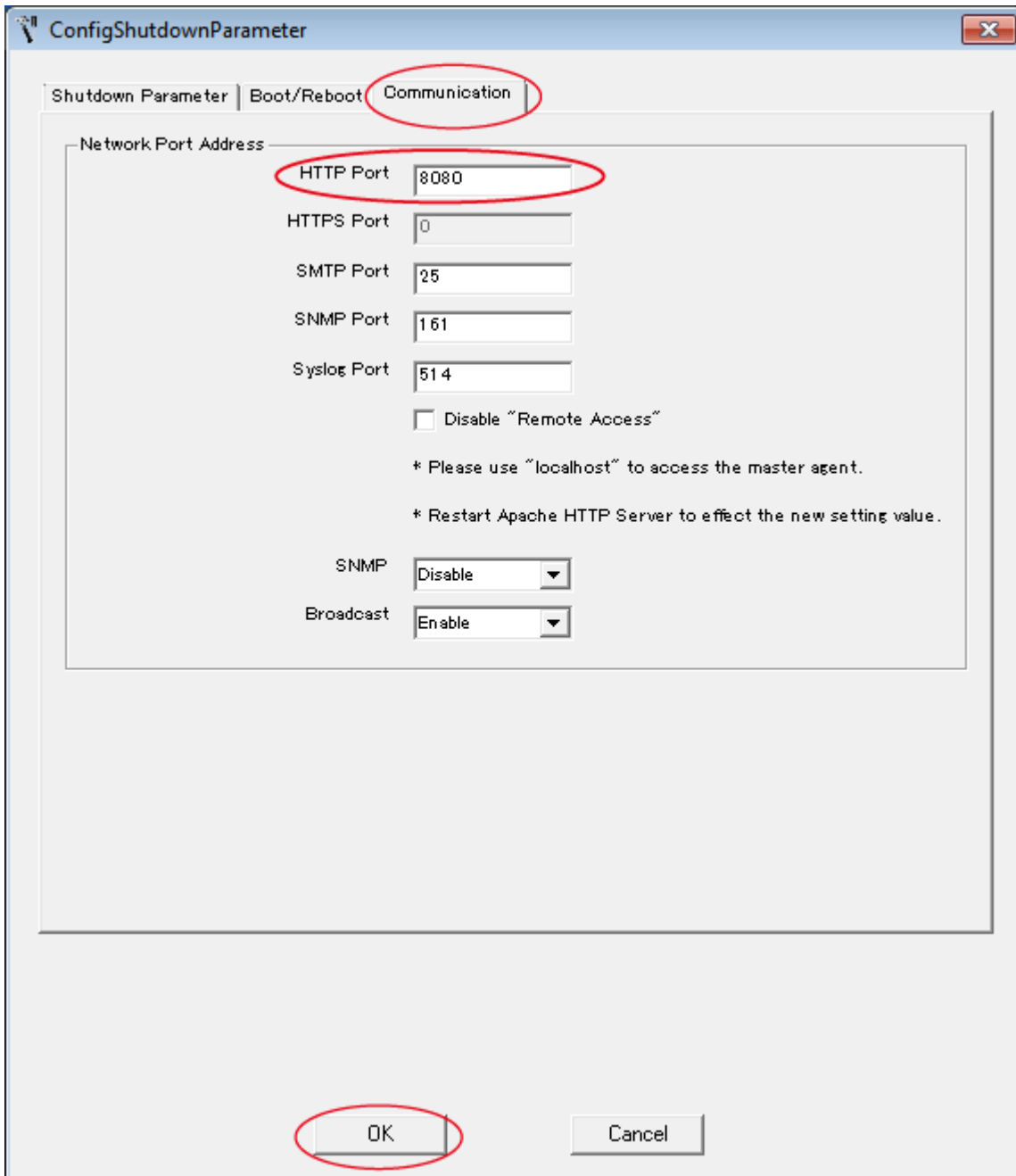
**CAUTION**

When "Yes" is selected for "Do you want to use SSL communication?" in step 20 on p.27, "3-1 Installing the software", also change the HTTPS port number (HTTPS port number default value: 443).

7-1-2 Changing the HTTP port number after installing the software

- 1 Right-click the PowerAct Pro resident-program icon in the task tray, and select [Agent Stop].

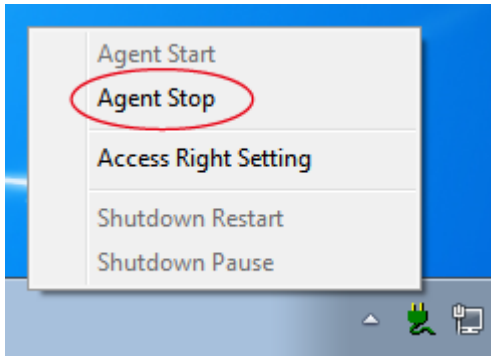

- 2 The Agent program stops and a red cross mark "x" appears on the icon.



- 3 Open File Explorer, select [OS (C:)], the [Program Files (x86)] folder, then the [PowerAct Pro(Master Agent)] folder, and double-click [ConfigShutdownParameter.exe].

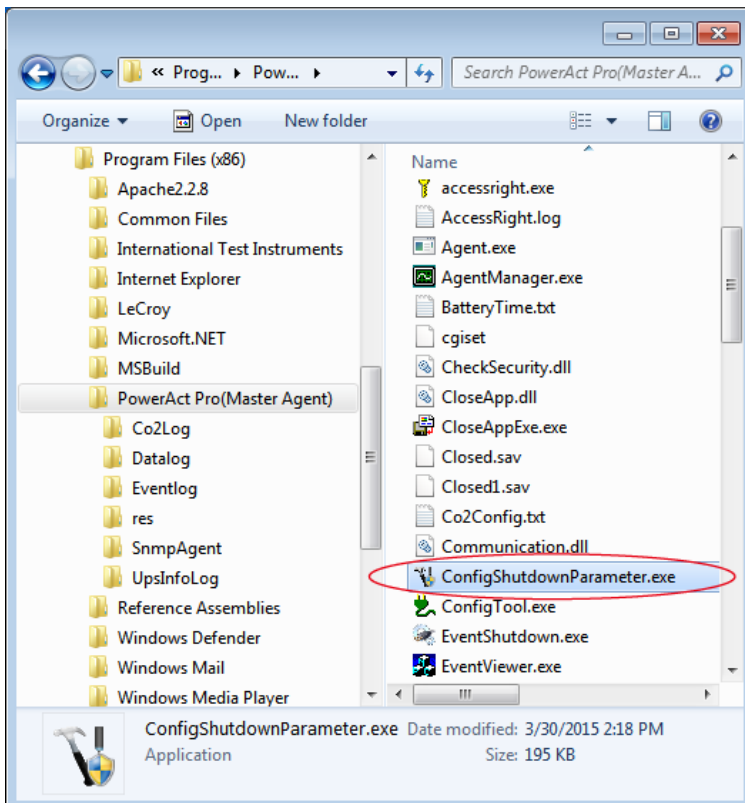

- 4 Click the [Communication] tab, change "80" in the "HTTP Port" field ("8080" in this example), and click the [OK] button (HTTP port number default value: 80).

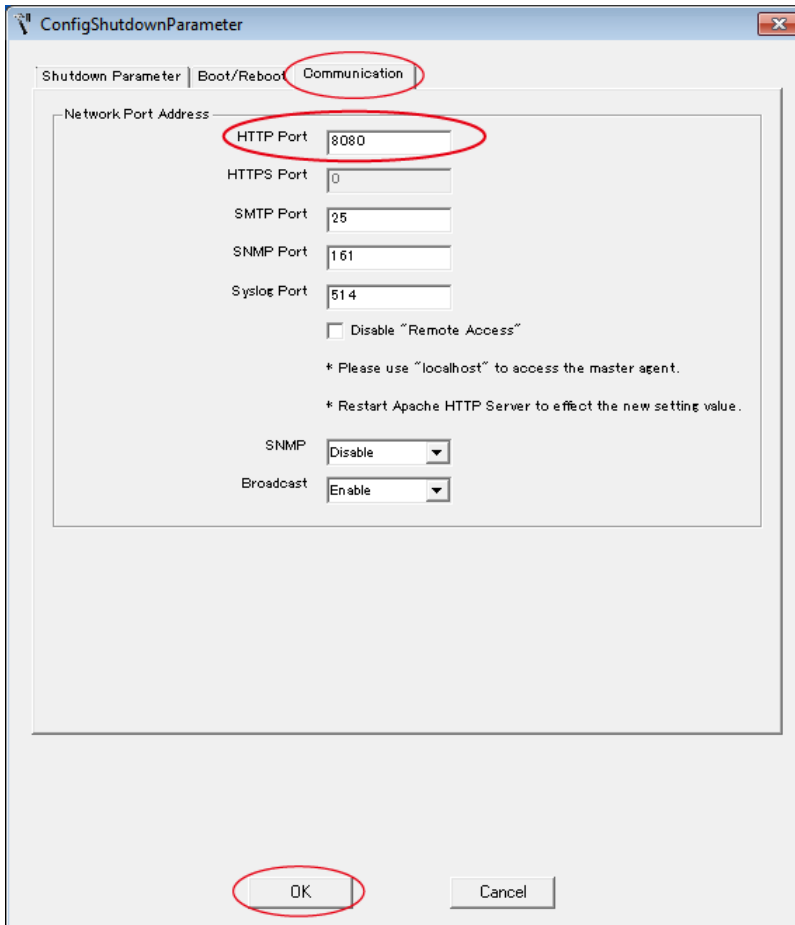

CAUTION

When "Yes" is selected for "Do you want to use SSL communication?" in step 20 on p.27, "3-1 Installing the software", also change the HTTPS port number (HTTPS port number default value: 443).

- 5 Right-click the PowerAct Pro resident-program icon in the task tray, and select [Agent Start].

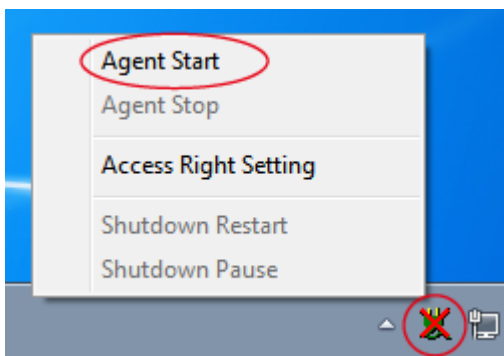

- 6 The Agent program starts and the red cross mark "x" disappears.



- 7 Right-click [PowerAct Pro Monitor] on Desktop, and select [Properties].

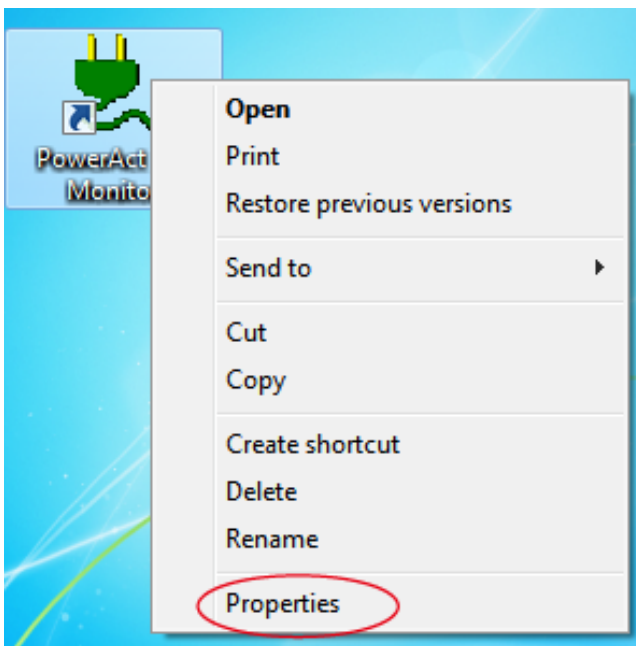

- 8 Click the [Security] tab.

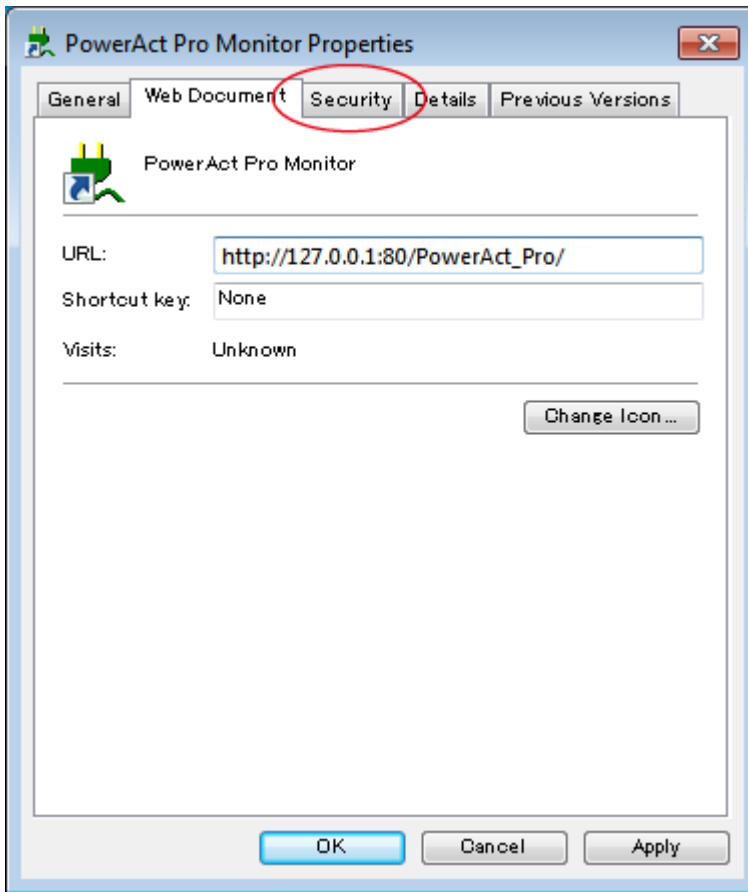

- 9 Click the [Edit...] button.

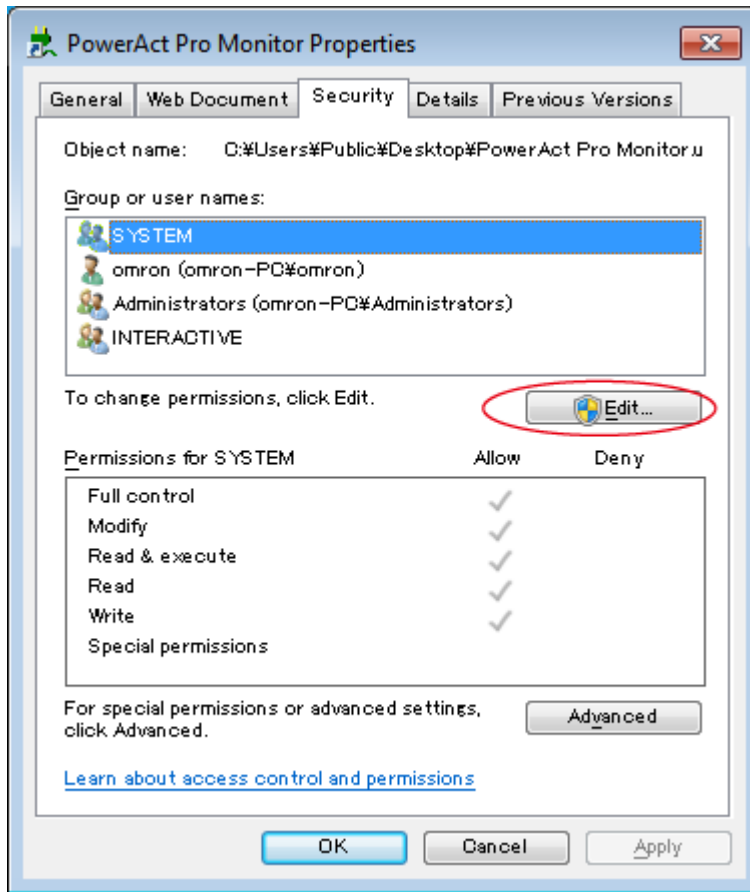

- 10 In the "Group or user names:" area, click the name of the logged-in user, select the "Full control" check box in the "Allow" column, and click the [Apply] button.

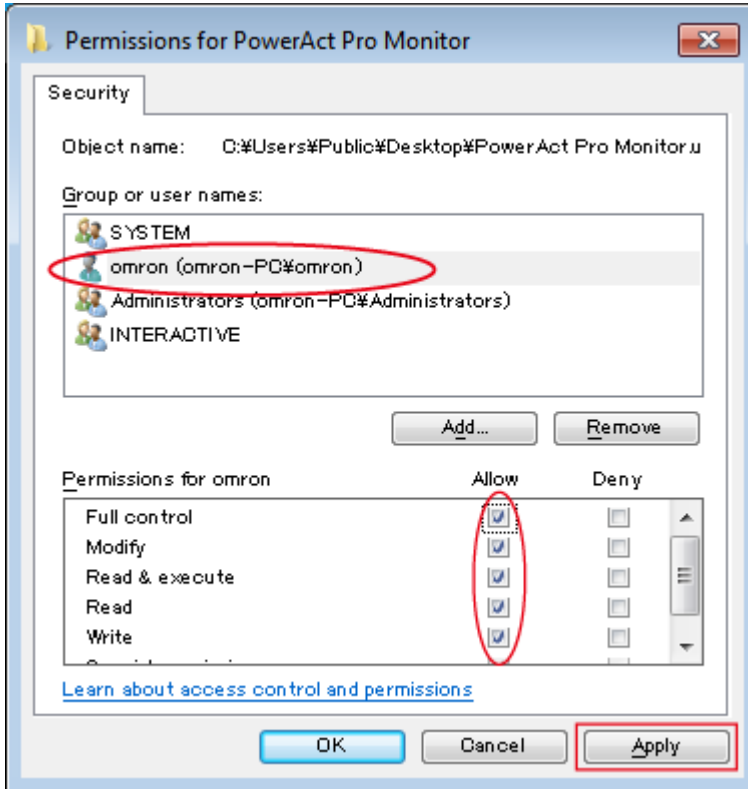

- 11 Click the [Web Document] tab, add the changed port number to the "URL:" field, and click the [OK] button.

Port number set in step 4 (Example: 8080)

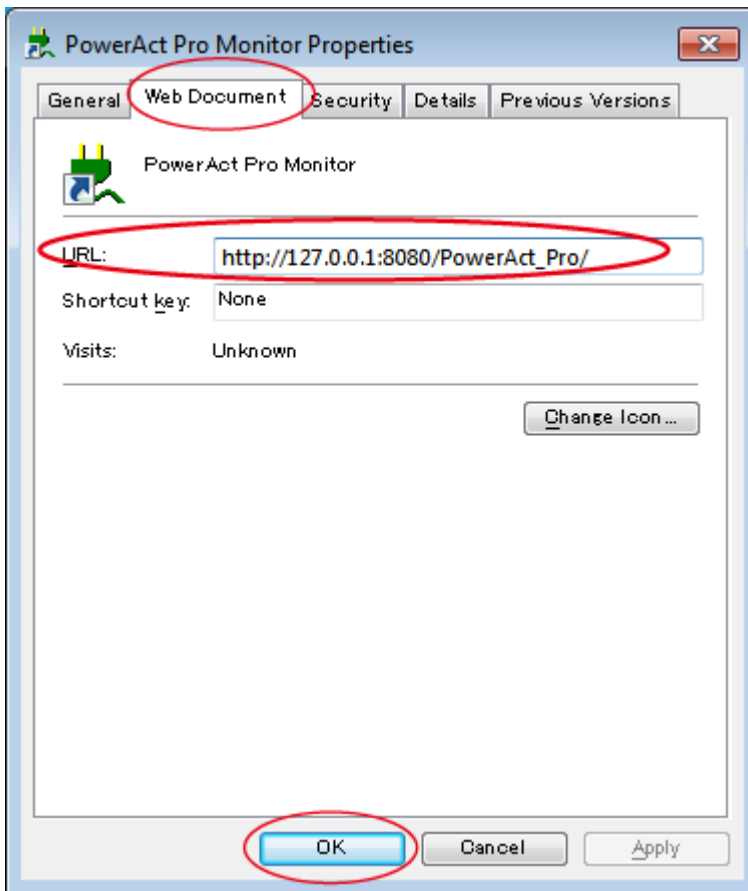

7-2 Unable to communicate with the UPS

The software communicates with the UPS via USP port or RS232C port (COM port). Establish communication between the software and the UPS by referring to the following chart.

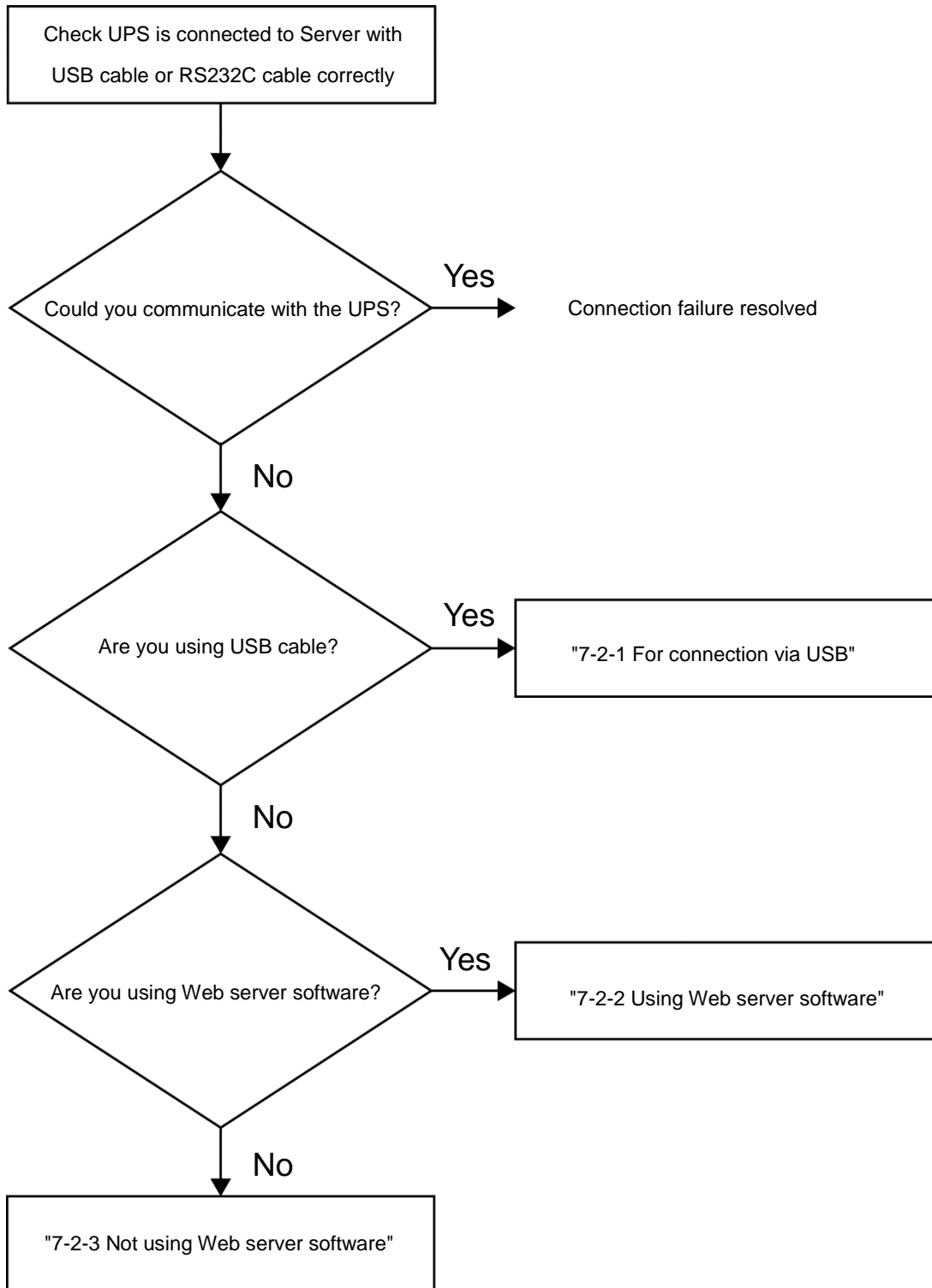

7-2-1 For connection via USB

- 1 Remove the USB cable from the server.
- 2 Connect the USB cable again, and wait for 30 seconds to one minute (a period of time required for detecting the UPS again).
- 3 When communication via USB is established, the PowerAct Pro resident-program icon in the task tray changes as follows:



Hint

If communication cannot be established by connecting the USB cable again, try again on another USB port. If communication cannot be established still, proceed to p.111, "7-2-2 Using Web server software", or p.114, "7-2-3 If not using Web server software (setting the communication port in "Auto" mode)".

7-2-2 Using Web server software

- 1 Double-click [PowerAct Pro Monitor] on Desktop.



- 2 Click the [Yes] button.

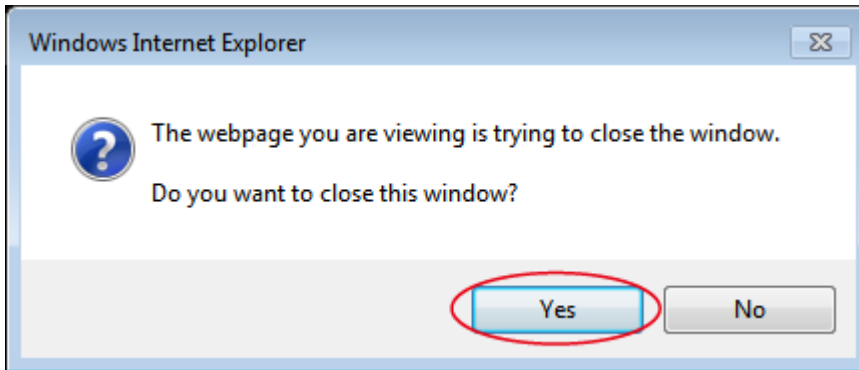

- 3 Click the name of server in which the software is installed.

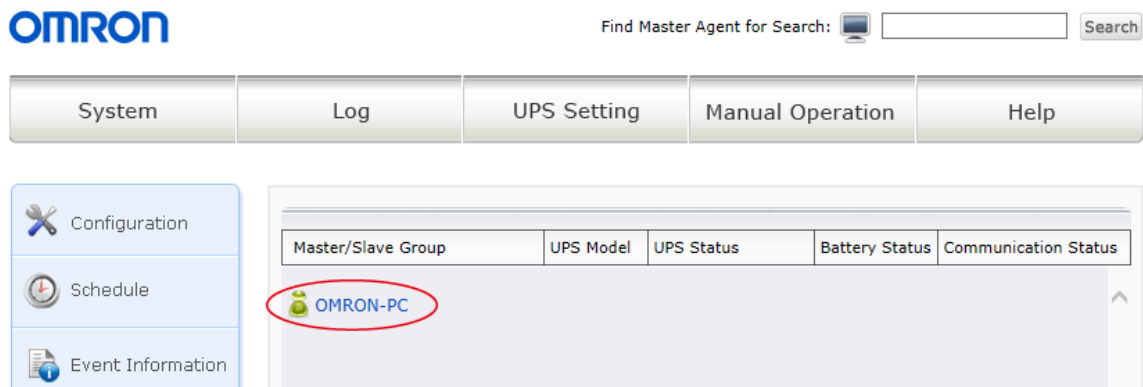

- 4 For "User ID", enter "Admin", and for "Password", enter the password set when the software was installed, and click the [OK] button.

OMRON

Login

User ID: Admin

Password: ●●●●●●

Ok Cancel

CAUTION

Note that a password value is case-sensitive.

- 5 Click [Configuration].

OMRON Find Master Agent for Search: Search

System Log UPS Setting Manual Operation Help

Date and Time: Next Battery Replace Date:

Battery Use Date (Battery Changed Date):

Configuration Schedule

UPS Model:
UPS Status:
Outlet A(No Control):

Buzzer Status:
Function Test Status :
Battery Auto Test:
UPS cold start status:

- 6 Click [Communication Setting].

OMRON

> Shutdown Parameter > UPS Boot/Reboot > Log Option > Communication Setting

Default

>> Shutdown Parameter

Select Agent OMRON-PC(Master) Submit

Select UPS Outlet Outlet A (No Control)

AC Fail Delav Time 60 Sec

- 7 Click the [Auto Search] button.

OMRON

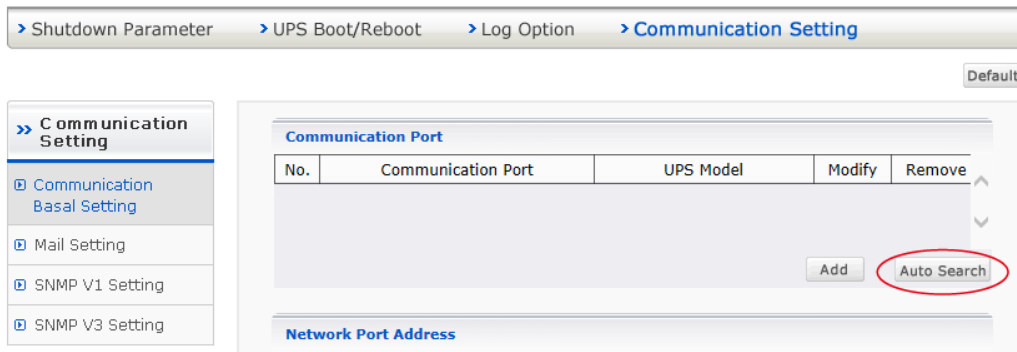

Hint

To set the communication port in "Manual" mode, click the [Add] button, select the COM port to which the UPS is connected, and click the [OK] button.

- 8 When the model name is displayed in the "UPS Model" column, communication is established.

OMRON

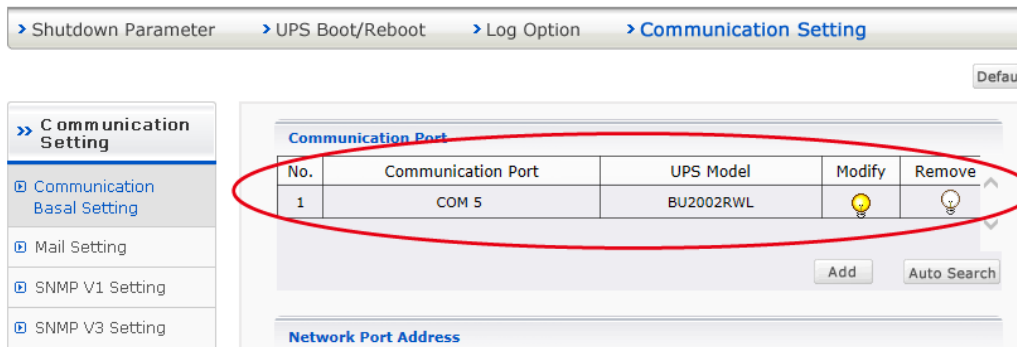

- 9 Close the Communication Setting window and the PowerAct Pro Monitor window.

- 3 Type "3" (Select by IP Address of Master Agent), type "127.0.0.1" in the "IP address of PowerAct Pro master agent:" field, and press the "Enter" key.

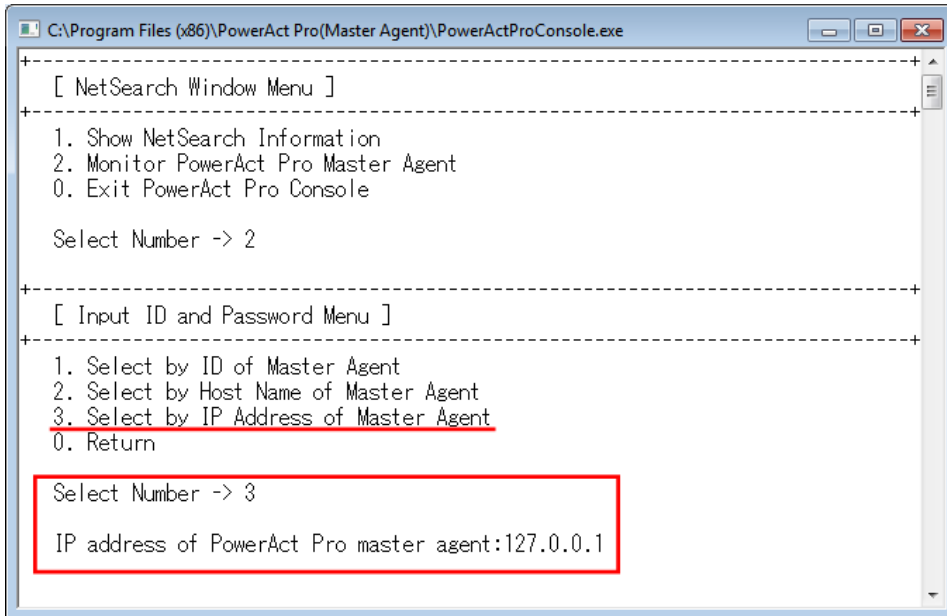

- 4 Type "Admin" in the "1. Login ID:" field, and press the "Enter" key. Then, in the "2. Password:" field, type the password set when the software was installed, and press the "Enter" key.

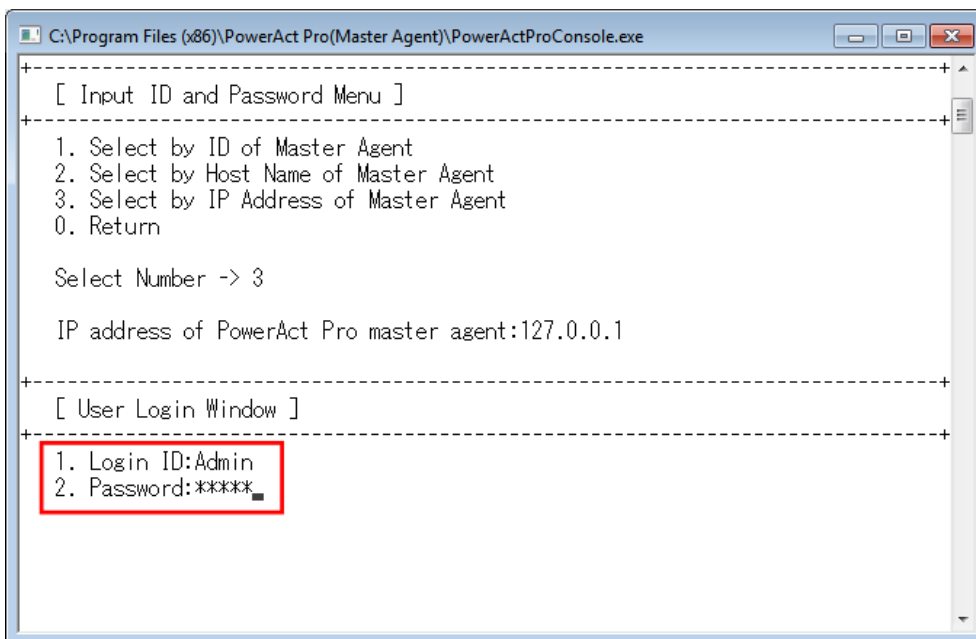

5 Press the "Q" key on the keyboard.

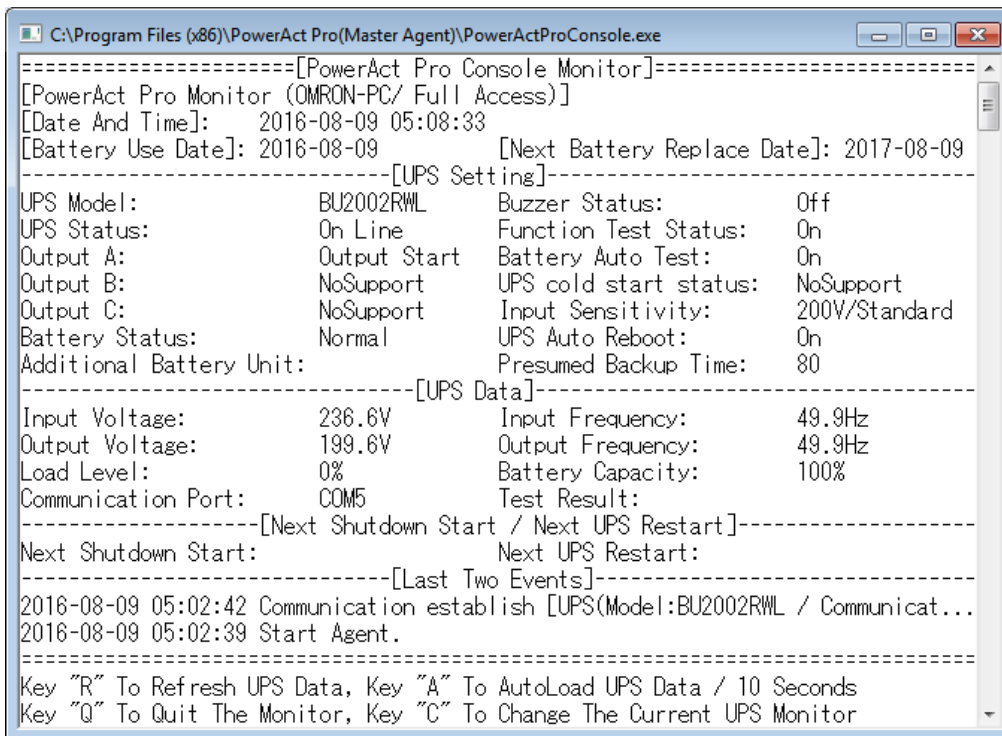

```

C:\Program Files (x86)\PowerAct Pro(Master Agent)\PowerActProConsole.exe
=====PowerAct Pro Console Monitor=====
[PowerAct Pro Monitor (OMRON-PC/ Full Access)]
[Date And Time]: 2016-08-09 05:08:33
[Battery Use Date]: 2016-08-09 [Next Battery Replace Date]: 2017-08-09
-----[UPS Setting]-----
UPS Model: BU2002RWL Buzzer Status: Off
UPS Status: On Line Function Test Status: On
Output A: Output Start Battery Auto Test: On
Output B: NoSupport UPS cold start status: NoSupport
Output C: NoSupport Input Sensitivity: 200V/Standard
Battery Status: Normal UPS Auto Reboot: On
Additional Battery Unit: Presumed Backup Time: 80
-----[UPS Data]-----
Input Voltage: 236.6V Input Frequency: 49.9Hz
Output Voltage: 199.6V Output Frequency: 49.9Hz
Load Level: 0% Battery Capacity: 100%
Communication Port: COM5 Test Result:
-----[Next Shutdown Start / Next UPS Restart]-----
Next Shutdown Start: Next UPS Restart:
-----[Last Two Events]-----
2016-08-09 05:02:42 Communication establish [UPS(Model:BU2002RWL / Communicat...
2016-08-09 05:02:39 Start Agent.
-----
Key "R" To Refresh UPS Data, Key "A" To AutoLoad UPS Data / 10 Seconds
Key "Q" To Quit The Monitor, Key "C" To Change The Current UPS Monitor
  
```

6 Type "1" (System Configuration), and press the "Enter" key.

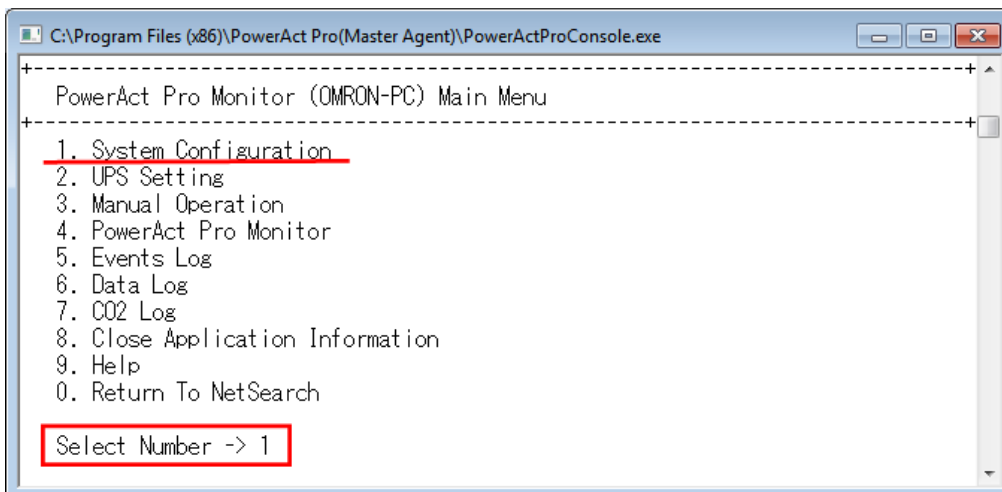

```

C:\Program Files (x86)\PowerAct Pro(Master Agent)\PowerActProConsole.exe
-----
PowerAct Pro Monitor (OMRON-PC) Main Menu
-----
1. System Configuration
2. UPS Setting
3. Manual Operation
4. PowerAct Pro Monitor
5. Events Log
6. Data Log
7. CO2 Log
8. Close Application Information
9. Help
0. Return To NetSearch

Select Number -> 1
  
```

7 Type "1" (Configuration), and press the "Enter" key.

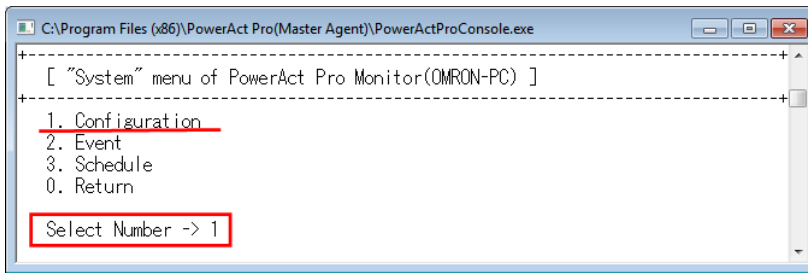

8 Type "4" (Communication Setting), and press the "Enter" key.

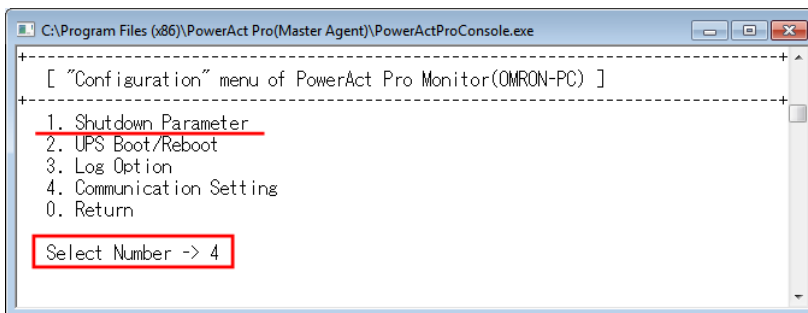

9 Type "1" (Communication Basal Setting), and press the "Enter" key.

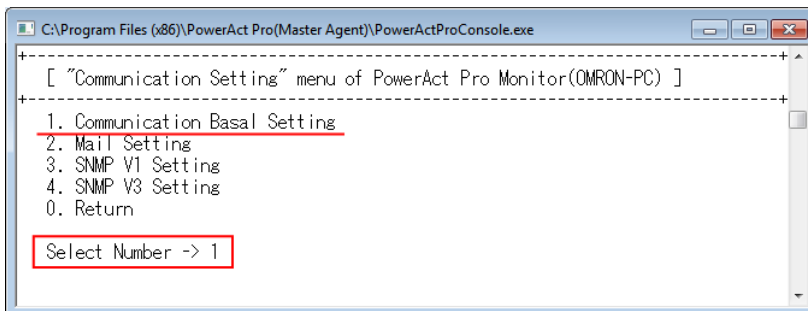

10 Type "11" (Communication Port Setting), and press the "Enter" key.

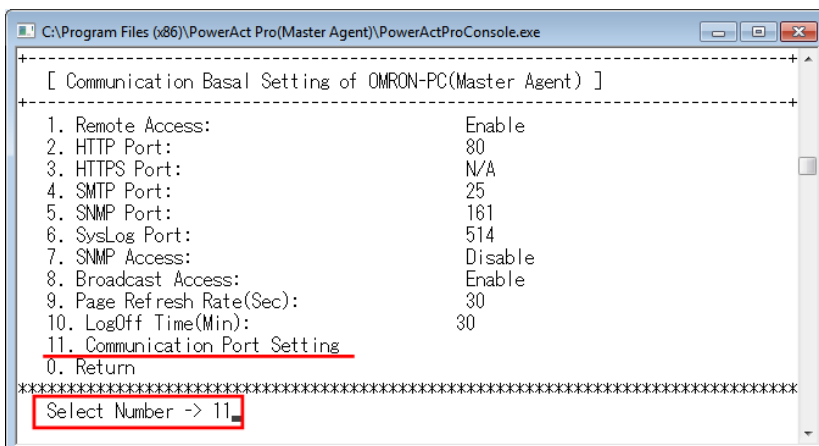

11 Type "1" (Auto), and press the "Enter" key.

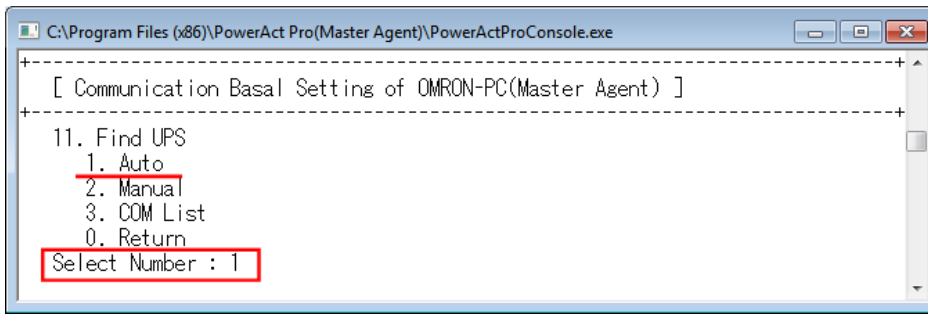

12 When the model name of the connected UPS is displayed in the "UPS Model" column, communication is established with the UPS (in this example, BN100S is detected on the USB port).

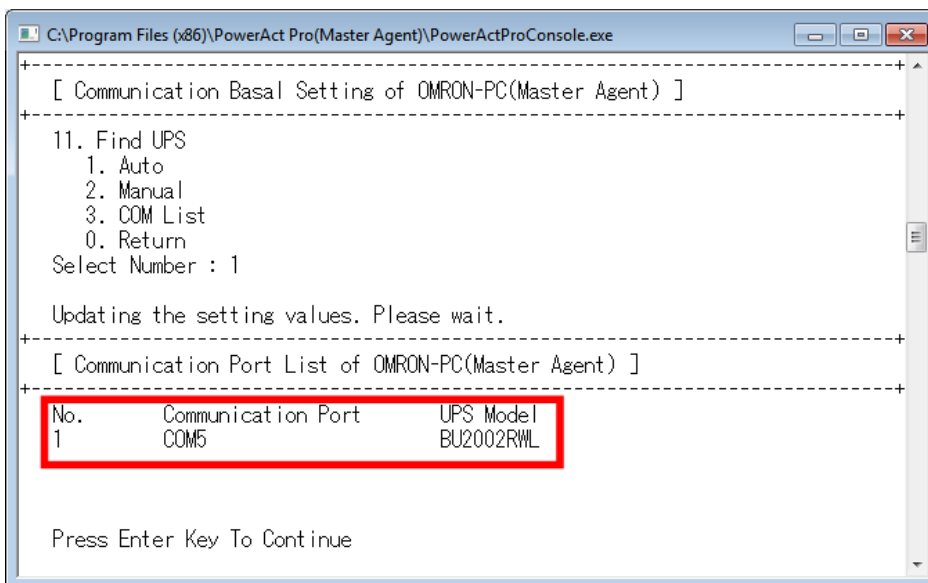

Hint

It may take time to automatically detect and display the UPS in "Communication Port List".

13 Press the "Enter" key to return to the window in step 10.

14 Type "0" (Return), press the "Enter" key, and return to the previous window, one window after another, to close "PowerActProConsole".

7-2-4 If not using Web server software (setting the communication port in "Manual" mode)

- 1 Open File Explorer, select [OS (C:)], the [Program Files (x86)] folder, then the [PowerAct Pro(Master Agent)] folder, and double-click [PowerActProConsole.exe].

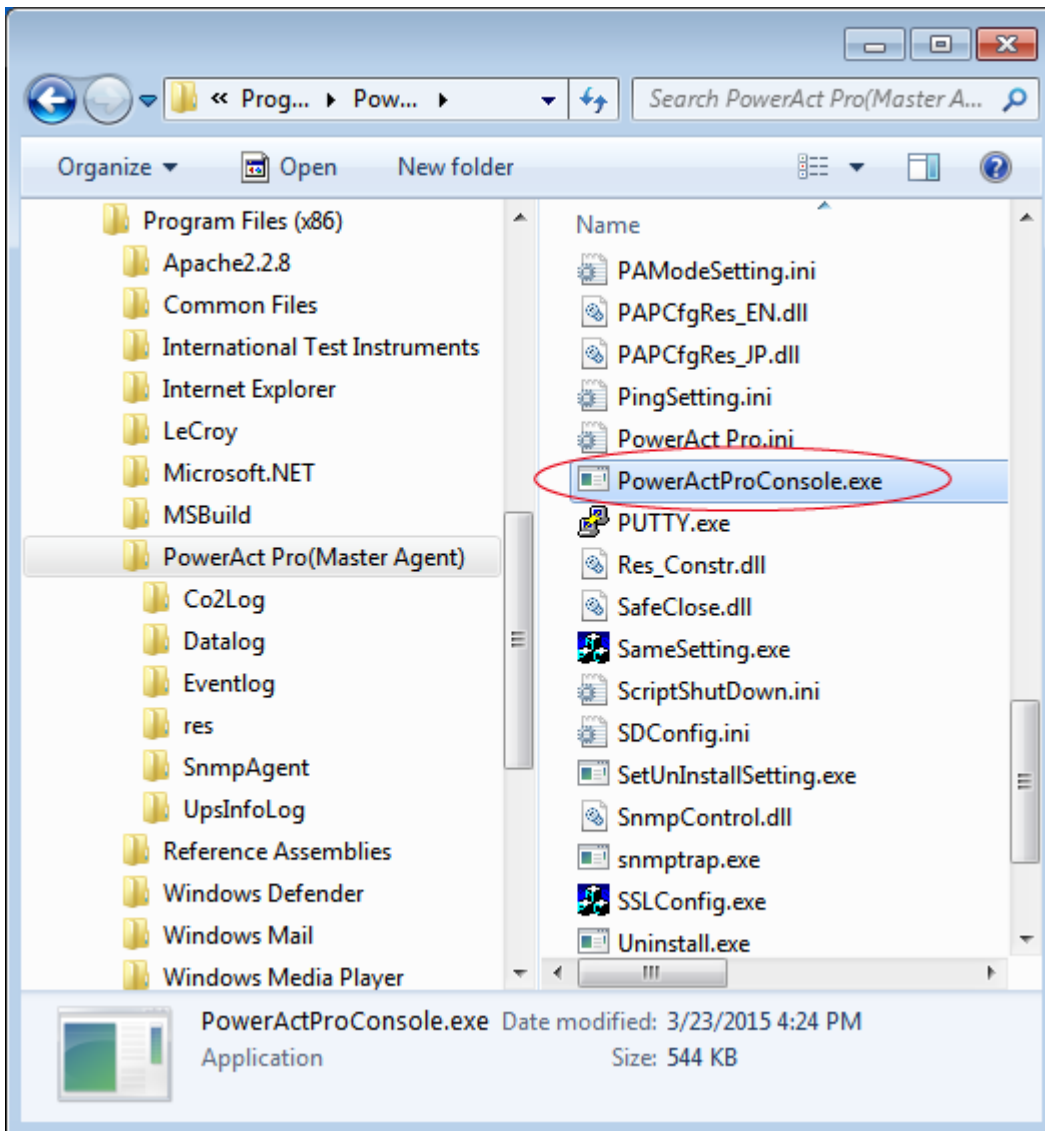

- 2 Type "2" (Monitor PowerAct Pro Master Agent), and press the "Enter" key.

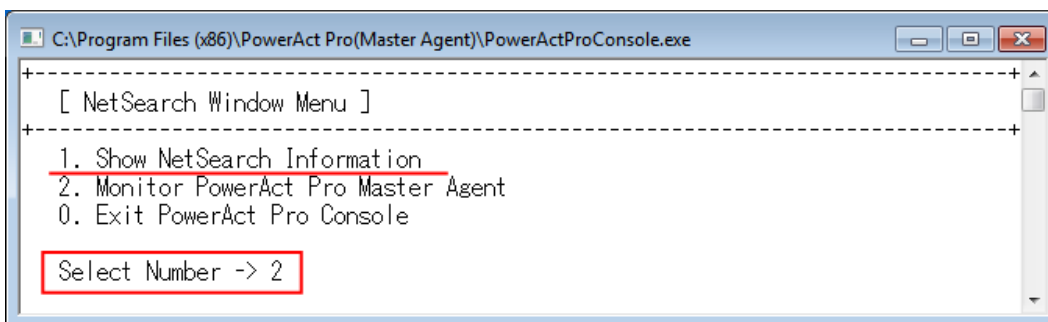

- 3 Type "3" (Select by IP Address of Master Agent), type "127.0.0.1" in the "IP address of PowerAct Pro master agent:" field, and press the "Enter" key.

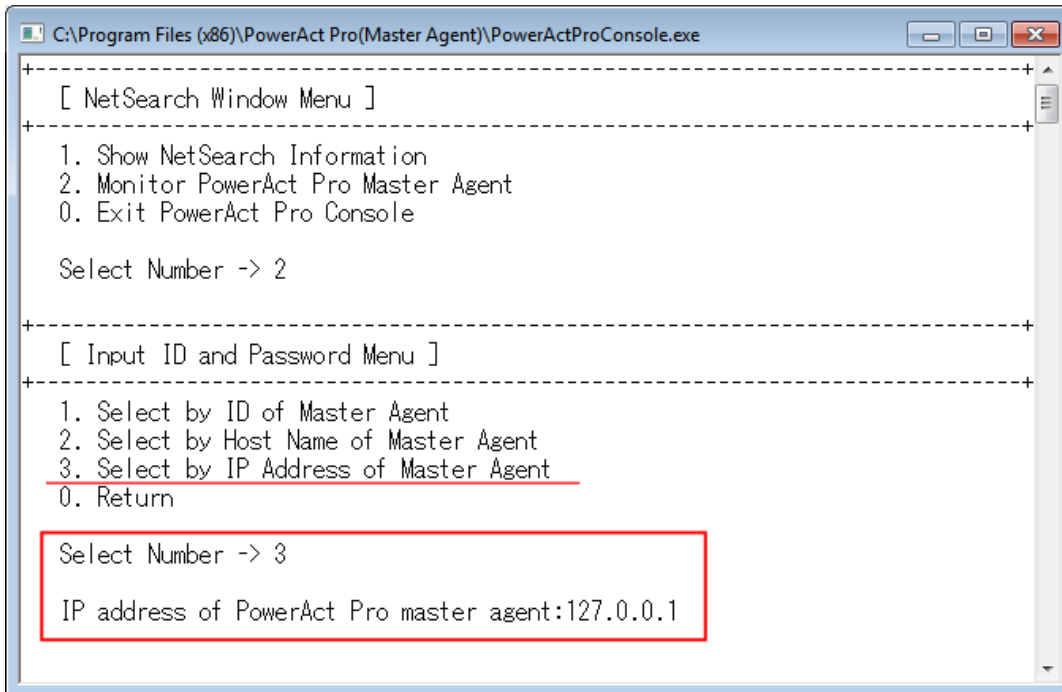

- 4 Type "Admin" in the "1. Login ID:" field, and press the "Enter" key. Then, in the "2. Password:" field, type the password set when the software was installed, and press the "Enter" key.

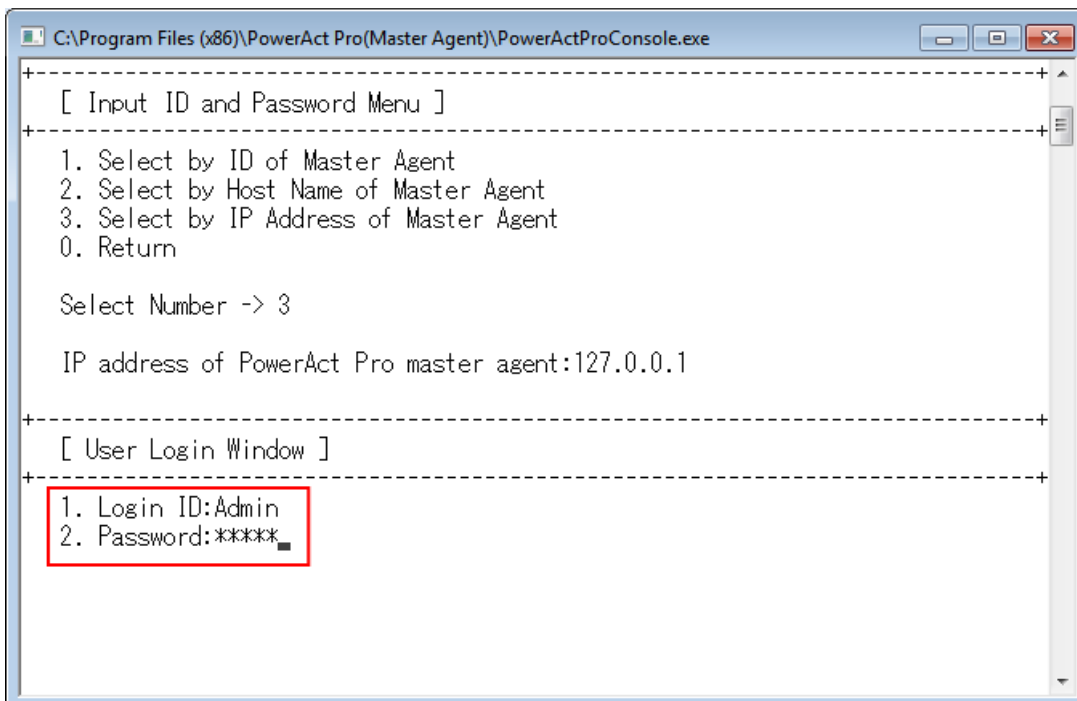

5 Press the "Q" key on the keyboard.

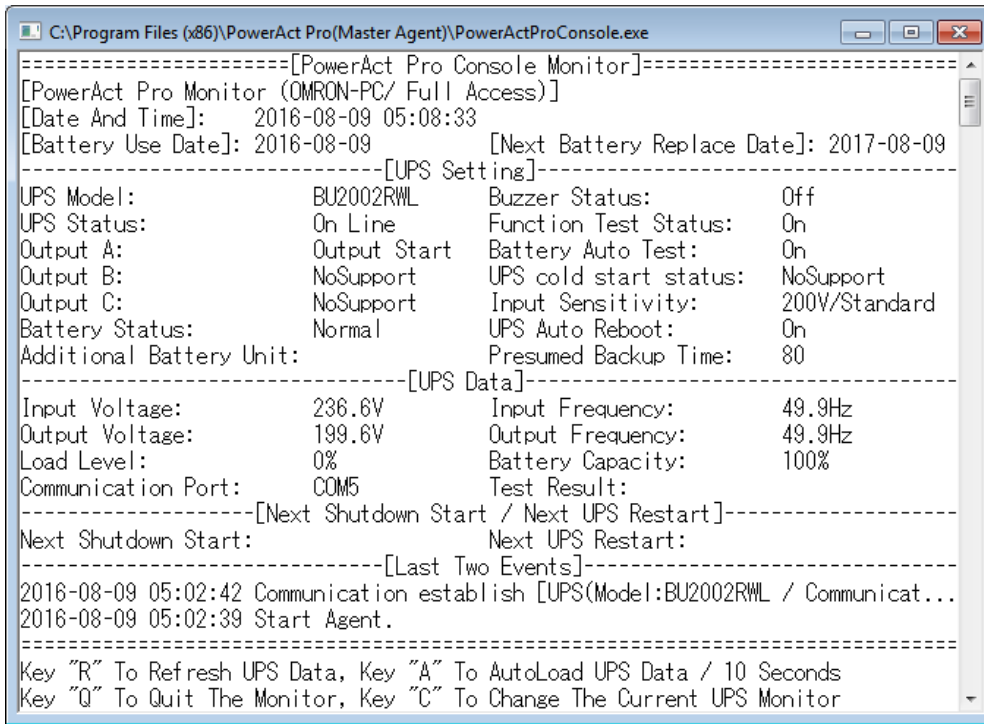

```

C:\Program Files (x86)\PowerAct Pro(Master Agent)\PowerActProConsole.exe
===== [PowerAct Pro Console Monitor] =====
[PowerAct Pro Monitor (OMRON-PC/ Full Access)]
[Date And Time]: 2016-08-09 05:08:33
[Battery Use Date]: 2016-08-09 [Next Battery Replace Date]: 2017-08-09
----- [UPS Setting] -----
UPS Model: BU2002RWL Buzzer Status: Off
UPS Status: On Line Function Test Status: On
Output A: Output Start Battery Auto Test: On
Output B: NoSupport UPS cold start status: NoSupport
Output C: NoSupport Input Sensitivity: 200V/Standard
Battery Status: Normal UPS Auto Reboot: On
Additional Battery Unit: Presumed Backup Time: 80
----- [UPS Data] -----
Input Voltage: 236.6V Input Frequency: 49.9Hz
Output Voltage: 199.6V Output Frequency: 49.9Hz
Load Level: 0% Battery Capacity: 100%
Communication Port: COM5 Test Result:
----- [Next Shutdown Start / Next UPS Restart] -----
Next Shutdown Start: Next UPS Restart:
----- [Last Two Events] -----
2016-08-09 05:02:42 Communication establish [UPS(Model:BU2002RWL / Communicat...
2016-08-09 05:02:39 Start Agent.
=====
Key "R" To Refresh UPS Data, Key "A" To AutoLoad UPS Data / 10 Seconds
Key "Q" To Quit The Monitor, Key "C" To Change The Current UPS Monitor
  
```

6 Type "1" (System Configuration), and press the "Enter" key.

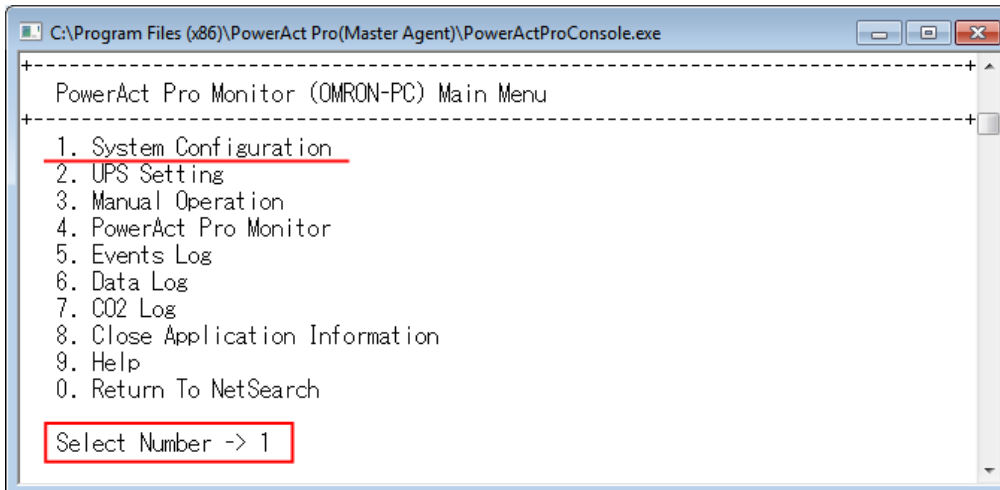

```

C:\Program Files (x86)\PowerAct Pro(Master Agent)\PowerActProConsole.exe
-----+-----
PowerAct Pro Monitor (OMRON-PC) Main Menu
-----+-----
1. System Configuration
2. UPS Setting
3. Manual Operation
4. PowerAct Pro Monitor
5. Events Log
6. Data Log
7. CO2 Log
8. Close Application Information
9. Help
0. Return To NetSearch

Select Number -> 1
  
```

7 Type "1" (Configuration), and press the "Enter" key.

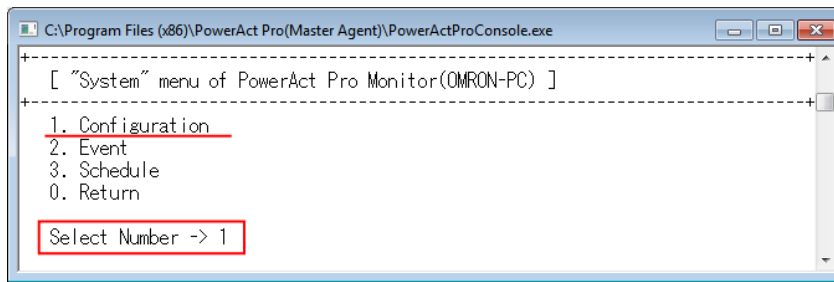

8 Type "4" (Communication Setting), and press the "Enter" key.

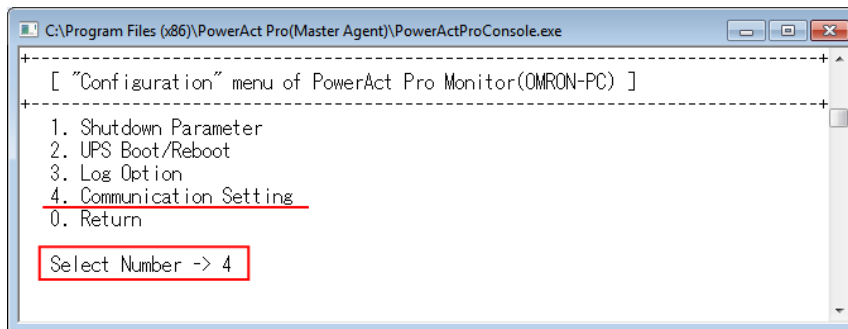

9 Type "1" (Communication Basal Setting), and press the "Enter" key.

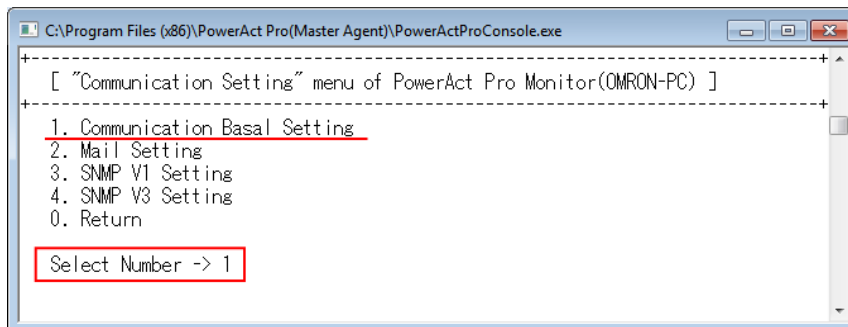

10 Type "11" (Communication Port Setting), and press the "Enter" key.

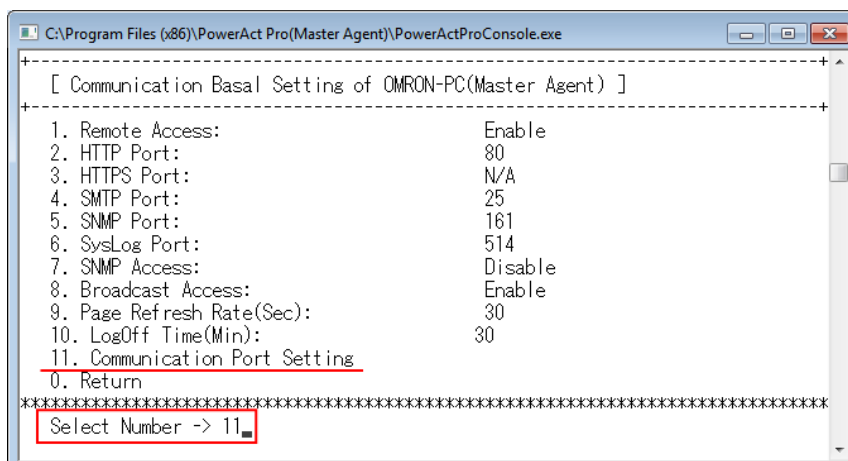

11 Type "2" (Manual), and press the "Enter" key.

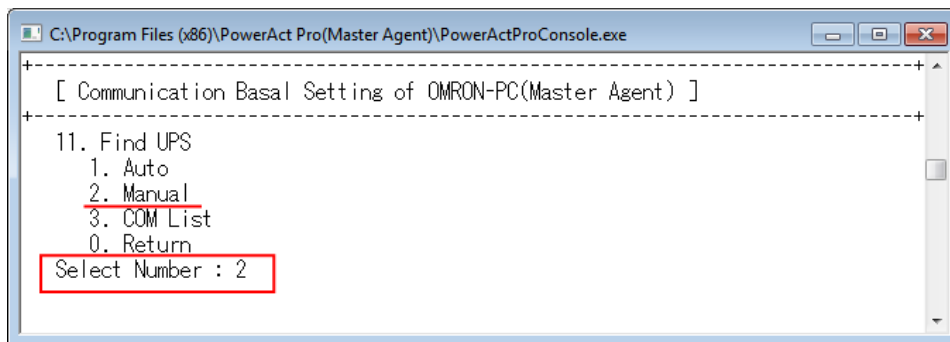

12 Type "2" (Add), and press the "Enter" key.

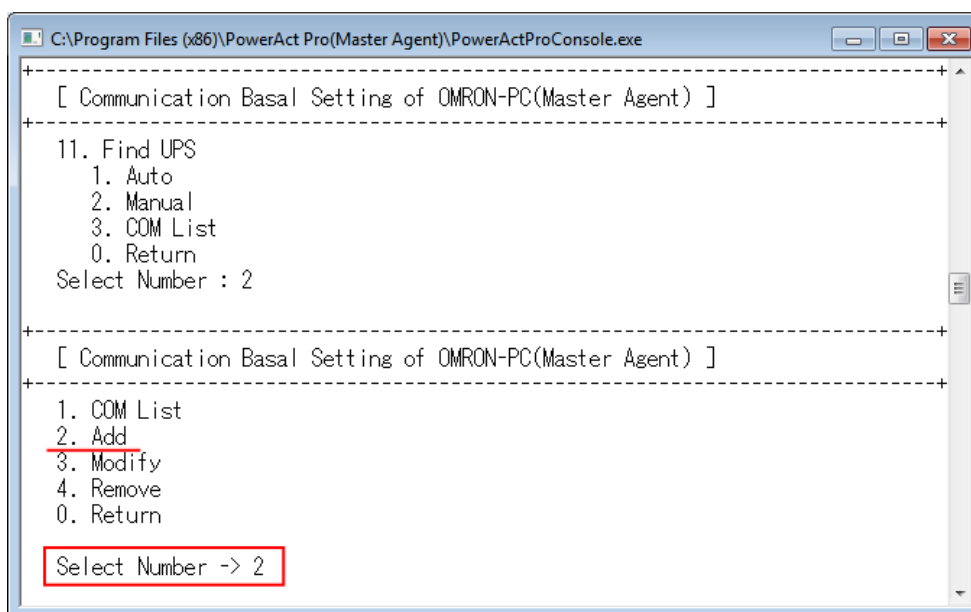

- 13 Type the number of the COM port to which the UPS is connected, and press the "Enter" key ("COM1" in this example).

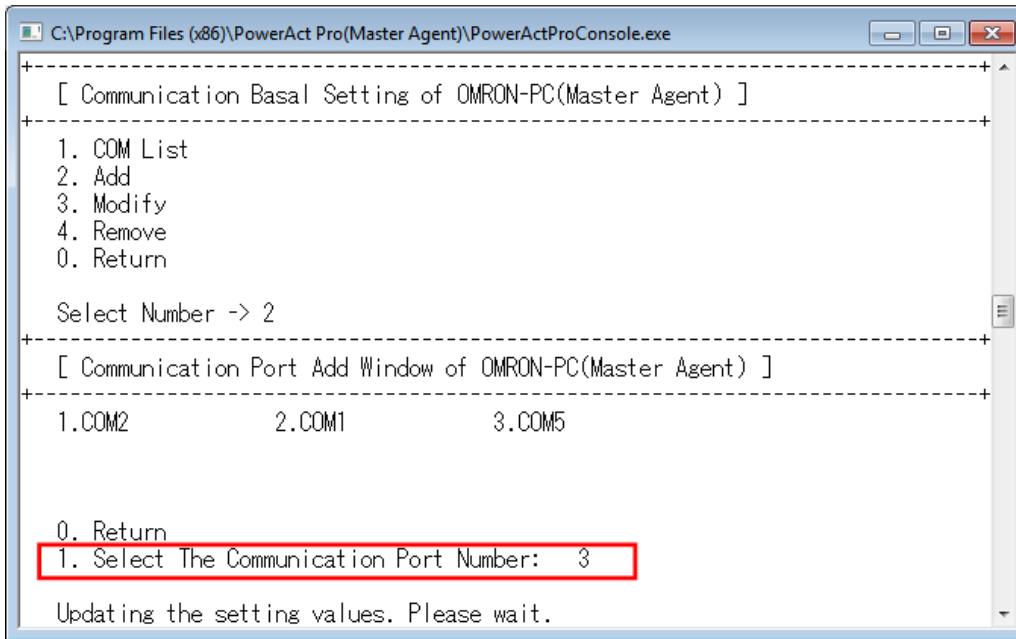

- 14 Type "1" (COM List), and press the "Enter" key.

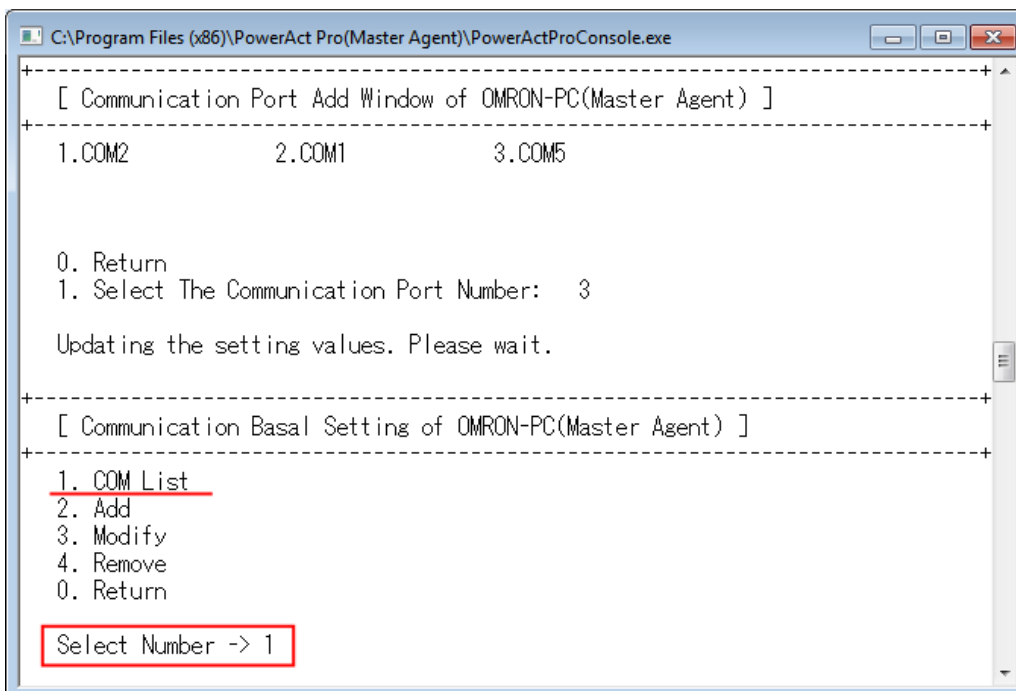

- 15 When the model name of the connected UPS is displayed in the "UPS Model" column, communication is established with the UPS (in this example, BN100S is detected on COM1).

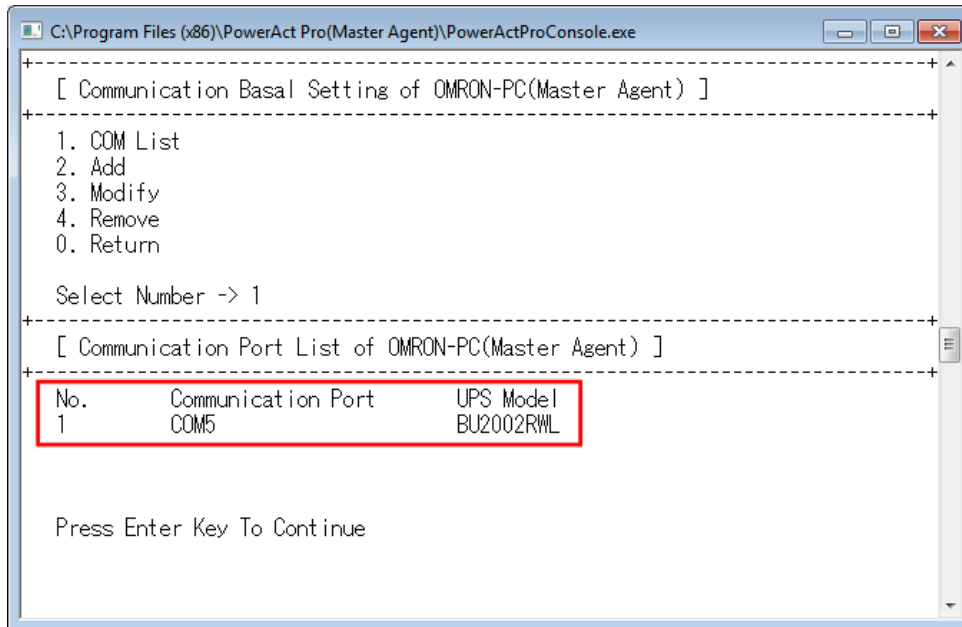

- 16 Press the "Enter" key to return to the window in step 10.

- 17 Type "0" (Return), press the "Enter" key, and return to the previous window, one window after another, to close "PowerActProConsole".

7-25 Selecting "Manual" in "Communication Port Setting"

- 1 Select "Manual", and click the [OK] button.

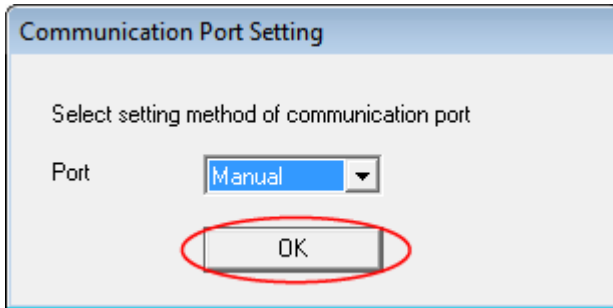

- 2 Select the COM port to which the UPS is connected, and click the [Add] button.

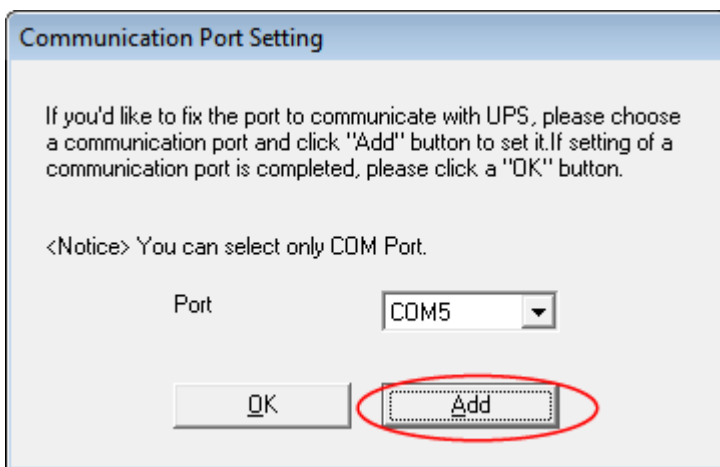

- 3 Click the [OK] button.

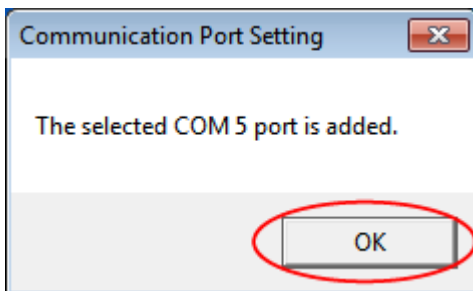

- 4 Click the [OK] button.

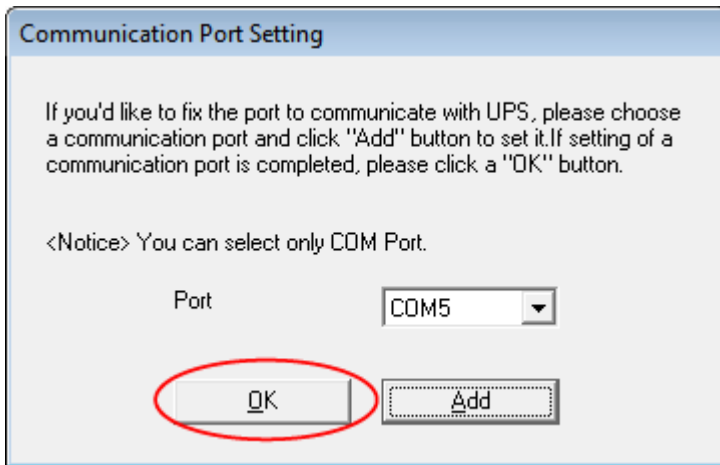

- 5 Check the result of communication on the selected COM port, and click the [OK] button.

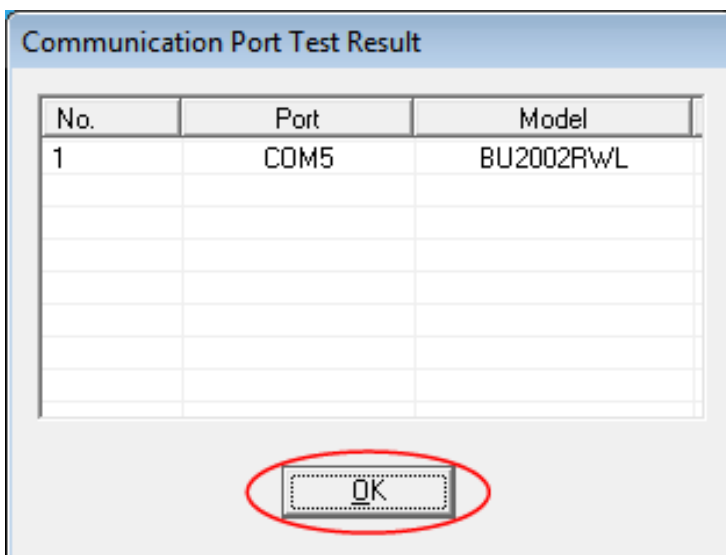

- 6 Return to the installation procedure for the software.

Using Apache	See step 23 on p.28.
Using IIS	See step 17 on p.57.
Not using Web server software	See step 16 on p.82.

Appendix

Appendix-1 Shutdown operation sequence

Appendix-1-1 Operation sequence with the initial settings

Initial settings

- AC Fail Delay Time: 60 seconds
- Shutdown Need Time: 180 seconds
- UPS Auto Stop: Yes

OS shutdown operation starts approximately 60 seconds after the software detects an input power supply abnormality. The UPS stops outputting power approximately 180 seconds after the start of OS shutdown operation.

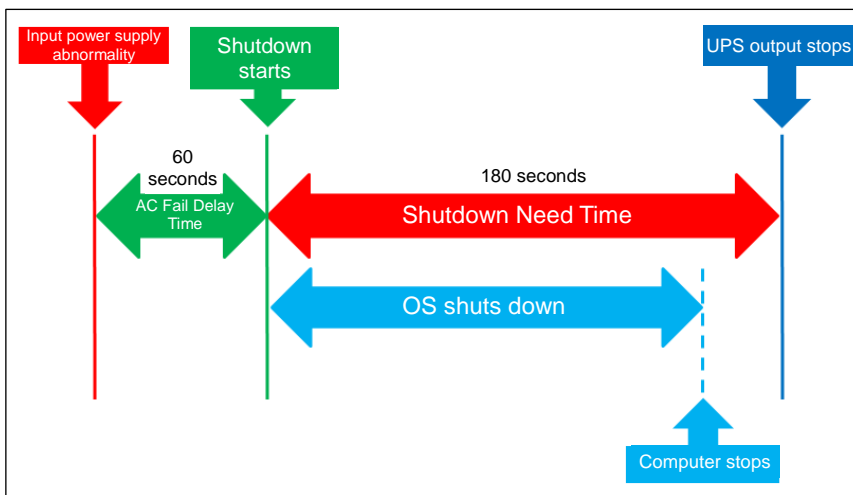

Hint

With the default values, it takes approximately 240 seconds from when the software detects an input power supply abnormality until the UPS stops outputting power.

Appendix-1-2 Operation sequence with values set for items other than the basic items (such as Shutdown Start Delay Time)

Setting example

- AC Fail Delay Time: 60 seconds
- Shutdown Start Delay Time: 60 seconds
- Run External Command Executed Time:
60 seconds
- Shutdown Need Time: 180 seconds
- UPS Auto Stop: Yes

When "60 seconds" is set for both "Shutdown Start Delay Time" and "Run External Command Executed Time", OS shutdown operation starts approximately 180 seconds after an input power supply abnormality is detected.

The UPS stops outputting power approximately 180 seconds after the start of OS shutdown operation.

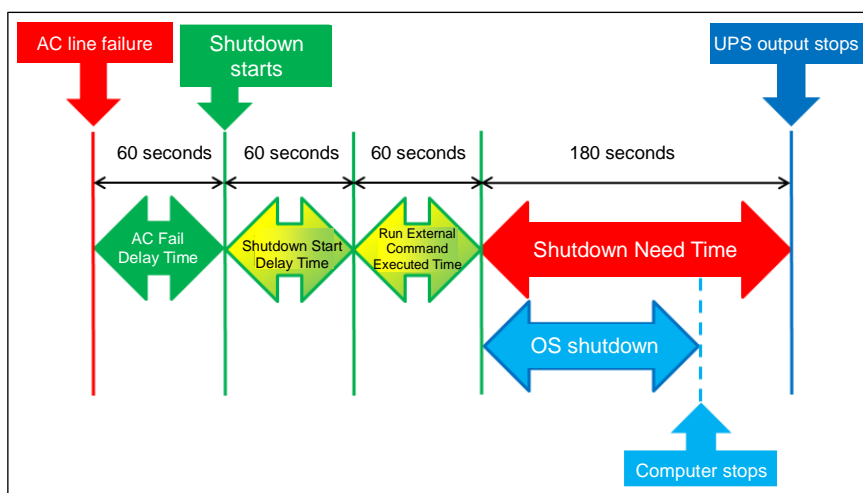

Hint

With these settings, it takes approximately 360 seconds from when the software detects an input power supply abnormality until the UPS stops outputting power.

The sum of the values for "Shutdown Start Delay Time", "Run External Command Executed Time", and "Shutdown Need Time" is maximum 1800 seconds for UPS with outlet control functionality, and maximum 600 seconds for UPS without outlet control functionality.

UPS models with outlet control functionality are as follows:

- BN220S/BN300S
- BN100XR/BN150XR/BN240XR
- BN75R/BN150R/BN300R
- BN100T/BN150T/BN220T/BN300T
- BU75RW/BU100RW/BU200RW/BU300RW
- BU1002SW/BU3002SW

Appendix-1-3 When power is restored before the UPS stops outputting power

With "Auto Stop" set to the UPS, when OS shutdown operation starts, the UPS always stops outputting power. If the computer is powered on before the UPS stops outputting power, the UPS stops its output in the middle of or after the startup of the OS, which may cause an error in the computer or any other connected device. To start up the computer manually, be sure to confirm first that the UPS stops outputting power.

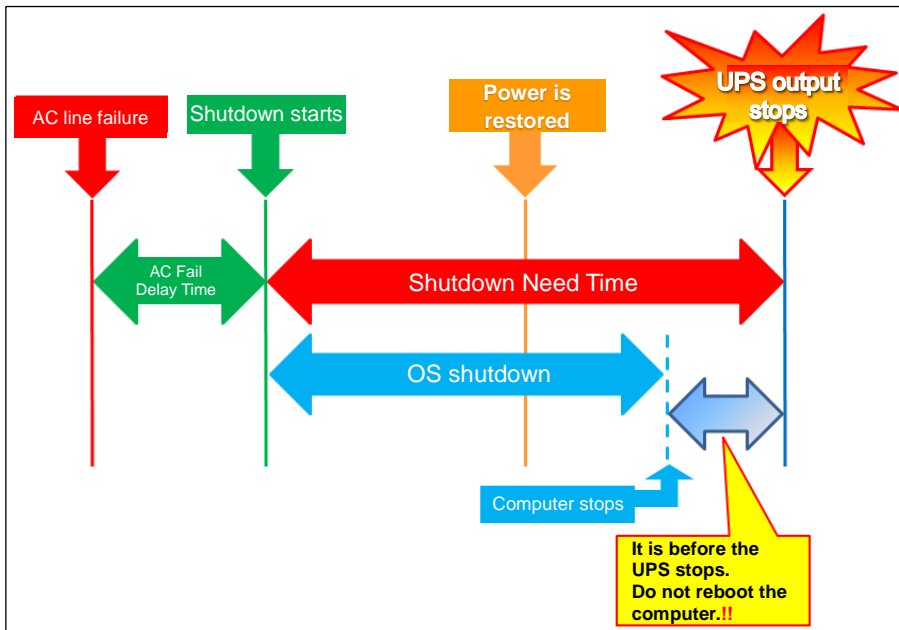

Hint

If you want to start up the server before the UPS automatically stops, reboot the UPS (turn OFF and ON by operating the power switch) once.

After rebooting, the UPS will not stop outputting power.

Appendix-2 Automatically starting the sever after power recovery

Appendix-2-1 Setting the UPS and computer to automatically start up

To automatically start up the server when power is restored after the UPS automatically has shut down due to an input power supply abnormality, set as follows:

- 1 Configure the setting that makes the UPS automatically start up when power is restored (factory default settings).

Hint

For models in which the UPS setting switches are used for this setting, set "#2" to "OFF". After changing the setting switch settings, the UPS must be stopped completely and rebooted. For details, see the instruction manual for each UPS model.

For models in which the UPS LCD menu is used for this setting, select "Settings", "Start Setting", then "Auto Reboot", and select the check box for "Enable".

- 2 In the BIOS settings of the computer, set the computer to automatically start up when power is restored.

- NEC (Express5800)

[Boot]-[After Power Failure]-[Power On]



- HP (ProLiant DL145)

[Power]-[After Power Failure]-[Power On]

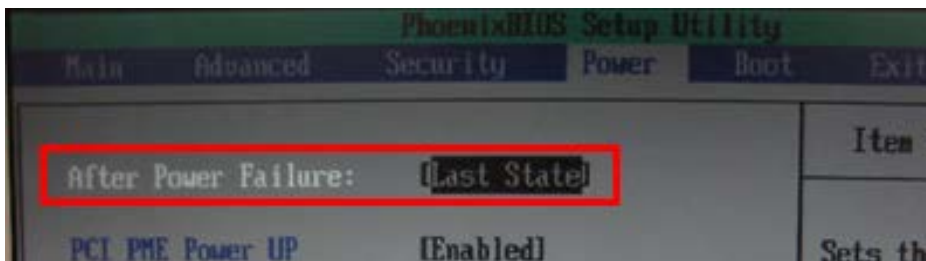

- HP (ProLiant DL DL360G6)

[Server Availability]-[Auto Power ON]-[Enable]

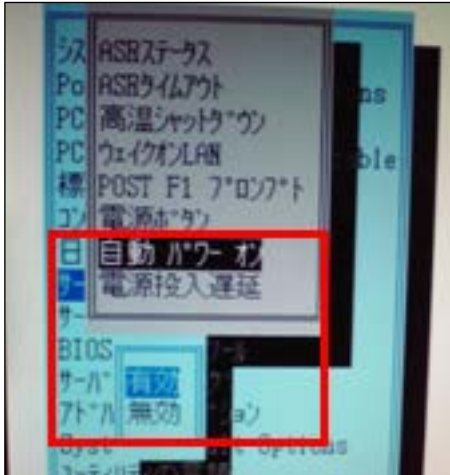

- Fujitsu (PRIMERGY RX100 S5)

[Power]-[Power Failure Recovery]-[Always On]

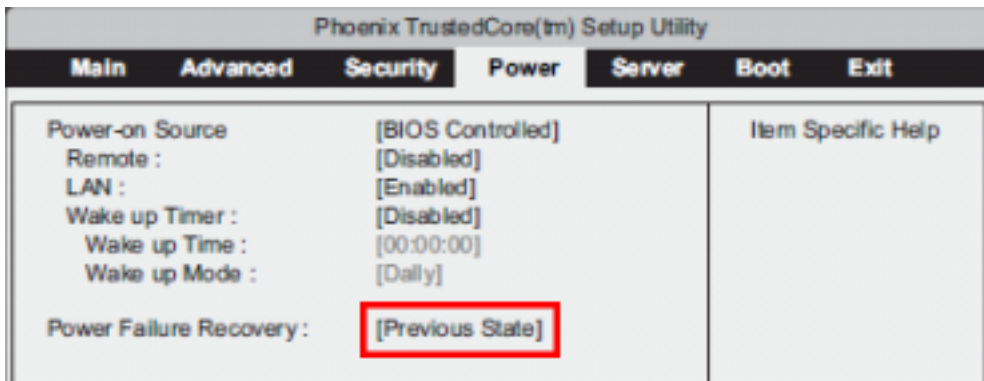

- Hitachi (HA8000)

In the BIOS setup menu, set "Start up system device upon AC power input".

Hint

For details on the BIOS settings, see the instruction manual for each computer.

Appendix-2-2 When power is restored before the UPS stops, if the computer does not automatically start up

After the OS starts shutting down, if power is restored before the UPS stops outputting power, a period of time with no output becomes short because the UPS automatically starts up immediately after stopping its output. This "short no-output time" may prevent the computer from starting up. So, extend the no-output time using "UPS Start Delay Time" to check if the computer automatically starts up.

Hint

If the time without input power supply is short, the computer may fail to completely discharge electricity accumulated inside, and may be unable to detect the powering off of the input power supply.

The time required for completely discharging electricity accumulated inside the computer varies depending on the computer. Therefore, adjust the value for "UPS Start Delay Time" according to the UPS mode in use.

■ Using Web server software

- 1 Log in to [PowerAct Pro Monitor] on Desktop, and open [Configuration], then [UPS Boot/Reboot].
- 2 Set a longer period of time for "UPS Start Delay Time" and update the setting using the[OK] button.

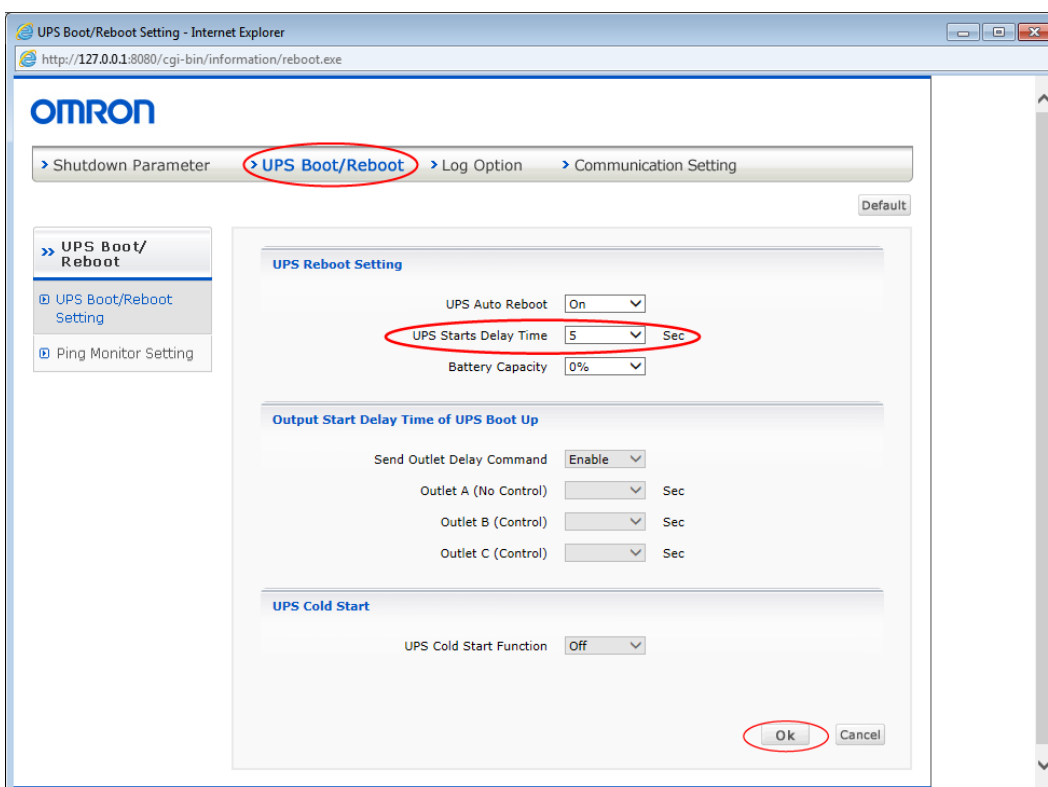

- 3 Close the UPS Boot/Reboot window using the [Cancel] button.

4 Select [System], then [Close] to close [PowerAct Pro Monitor].

The screenshot shows the Power Act Pro Monitor OMRON-PC (Full Access) web interface. The browser title is "Power Act Pro Monitor OMRON-PC (Full Access) - Internet Explorer" and the address bar shows "http://127.0.0.1:8080/cgi-bin/information/firstpage.exe?iUPSNu=0". The OMRON logo is at the top left, and a search bar is at the top right. The main navigation menu includes "System", "Log", "UPS Setting", "Manual Operation", and "Help". The "System" menu is highlighted with a red circle, and the "Close" option is also highlighted with a red circle. The main display area shows the following information:

- Time: 06:14:12
- Next Battery Replace Date: 2017-08-09
- Changed Date: 2016-08-09
- UPS Model: BU2002RWL
- UPS Status: On Line
- Outlet A(No Control): Output Start
- Outlet B(Control): NoSupport
- Outlet C(Control): NoSupport
- Battery Status: Normal
- Additional Battery Units: (empty)
- Buzzer Status: Off
- Function Test Status: On
- Battery Auto Test: On
- UPS cold start status: NoSupport
- Input/Output Setting: 200V/Standard
- UPS Auto Reboot: On
- Communication Port: COM 5
- Submit button
- Test Result: (empty)

The main display area also features several horizontal bar charts and numerical readouts:

- Input Voltage: 237.3 V (Scale: 80, 120, 160, 200, 240, 280)
- Output Voltage: 199.6 V (Scale: 80, 120, 160, 200, 240, 280)
- Input Frequency: 49.9 Hz (Scale: 40, 45, 50, 55, 60, 65)
- Output Frequency: 49.9 Hz (Scale: 40, 45, 50, 55, 60, 65)
- Load Level: 0% (Scale: 0, 25, 50, 75, 100, 125)
- Battery Capacity: 100% (Scale: 0, 25, 50, 75, 100, 125)

- Not using Web server software

1 Right-click the PowerAct Pro resident-program icon in the task tray, and select [Agent Stop].

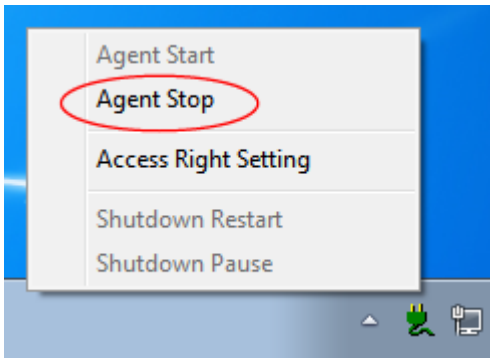

2 The Agent program stops and a red cross mark "x" appears on the icon.



- 3 Double-click [ConfigShutdownParameter] on Desktop, and in the Boot/Reboot tab page, set a longer period of time for "UPS Start Delay Time", and click the [OK] button.

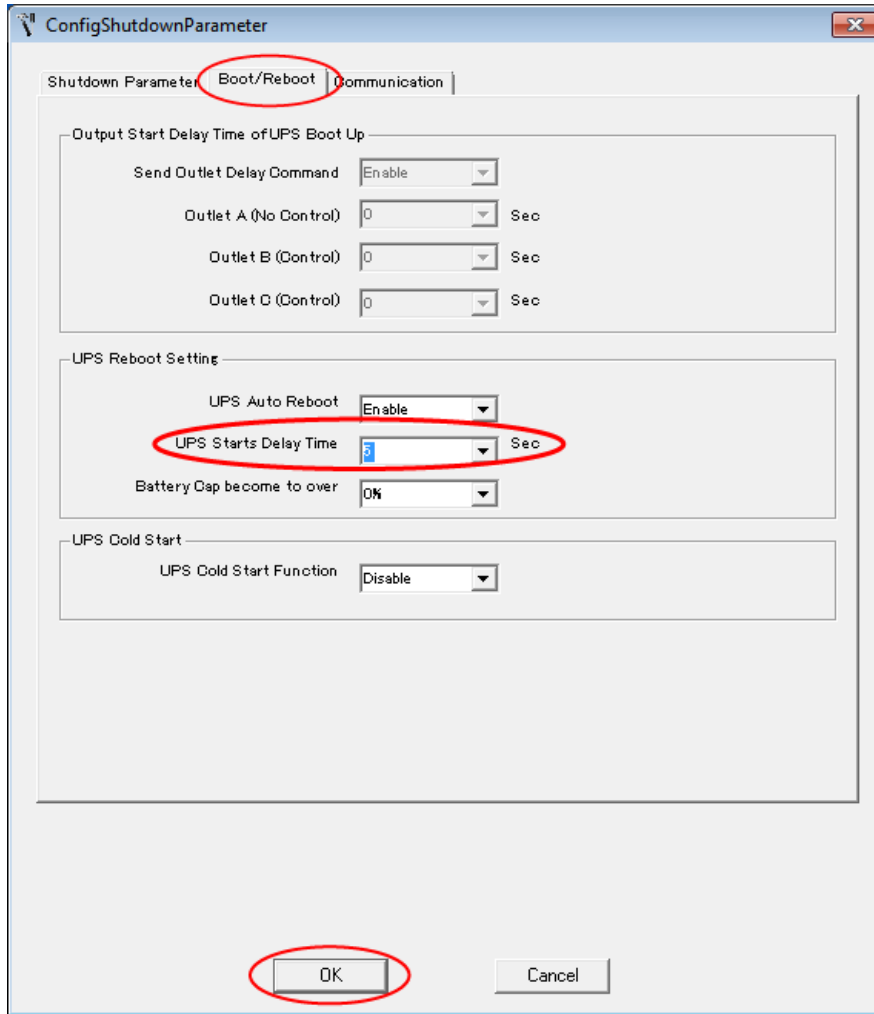

- 4 Right-click the PowerAct Pro resident-program icon in the task tray, and select [Agent Start].

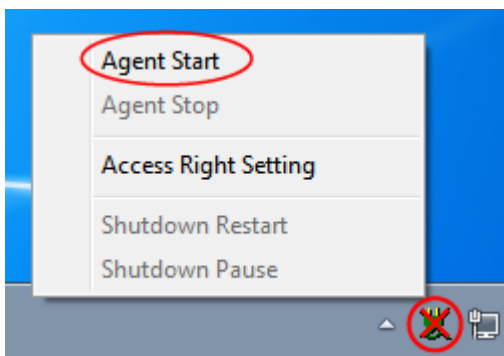

- 5 The Agent program starts and the red cross mark "x" disappears.



Appendix-3 How to remove the software

- 1 Select [Control Panel], then [Programs and Features], and double-click "PowerAct Pro(Master Agent)".

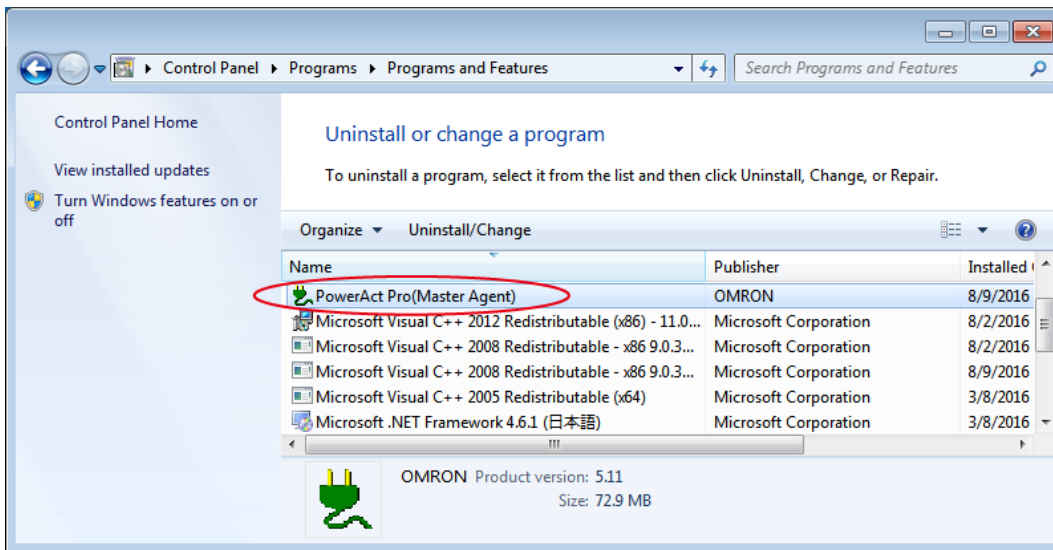

Hint

The software can be removed also by the installer. Delete the software by starting the same version of Setup.exe as the version of the software.

- 2 Click the [Yes] button.

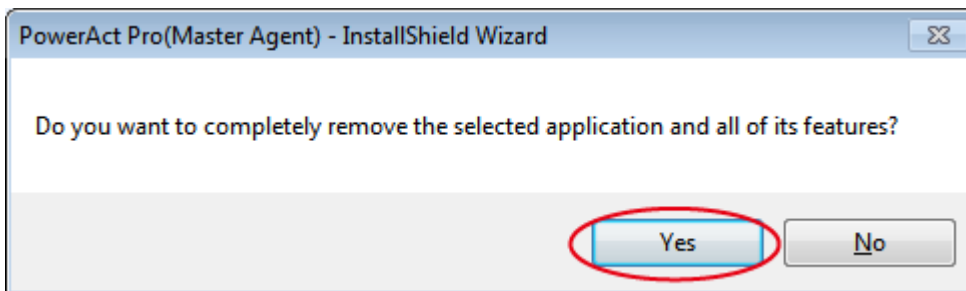

- 3 Click the [Finish] button.

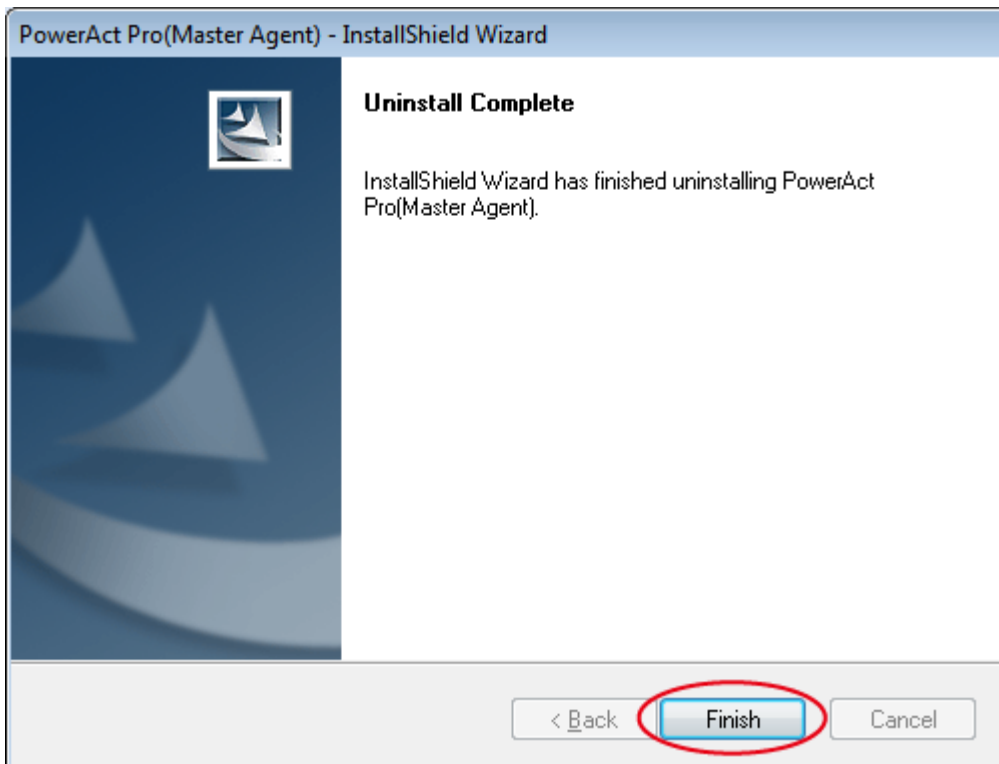

Hint

If Apache is used, remove "Apache 2.2.8" in the same way.

- 4 Restart Windows Server 2012R2.

Then, the software is removed completely.

No part or whole of this manual may be reproduced without permission.
The contents of this manual are subject to change without notice.

OMRON SOCIAL SOLUTIONS CO.,LTD.

K1L-D-16014B